



US00D457613S

(12) **United States Design Patent** (10) **Patent No.:** **US D457,613 S**
Schaefer (45) **Date of Patent:** **** May 21, 2002**

(54) **COMBINATION RESERVOIR AND MISTING FAN WITH A SOLID SIDEWALL**

(76) Inventor: **Ronald E. Schaefer**, 514 10th St., Sartell, MN (US) 56377

(**) Term: **14 Years**

(21) Appl. No.: **29/138,383**

(22) Filed: **Mar. 12, 2001**

(51) **LOC (7) Cl.** **23-04**

(52) **U.S. Cl.** **D23/328; D23/370; D23/382**

(58) **Field of Search** **D23/381, 382, D23/332, 328, 370; 416/95 R, 247, 146 R, 63; D9/518, 387**

(56) **References Cited**

U.S. PATENT DOCUMENTS

D184,469 S	*	2/1959	Zeller et al.	D23/382
4,443,965 A	*	4/1984	Gie	416/247
4,818,183 A		4/1989	Schaefer		
4,981,214 A		1/1991	Rojas		
5,295,811 A	*	3/1994	Chin	D23/382
5,647,499 A		7/1997	Piazza		
D386,572 S		11/1997	Radtke		
D434,840 S		12/2000	Schaefer		
D440,288 S		4/2001	Schaefer		

OTHER PUBLICATIONS

Packaging, Can A, bottom left side of page, Sep. 1985.
 Packaging, Can B, top right side of page, Sep. 1987.

* cited by examiner

Primary Examiner—Lisa Lichtenstein
 (74) *Attorney, Agent, or Firm*—Gerald E. Helget; Briggs and Morgan, P.A.

(57) **CLAIM**

The ornamental design for a combination reservoir and misting fan with a solid sidewall, as shown and described.

DESCRIPTION

FIG. 1 is a front elevational view showing my new design for a combination reservoir and misting fan with a solid side wall;;
 FIG. 2 is a left side elevational view;
 FIG. 3 is a rear elevational view;
 FIG. 4 is a right side elevational view;
 FIG. 5 is a top plan view;
 FIG. 6 is a bottom plan view; and,
 FIG. 7 is a perspective view.
 The broken line showing of environmental structure in FIGS. 1-4 and 7 is for illustrative purposes only and forms no part of the claimed design.

1 Claim, 4 Drawing Sheets

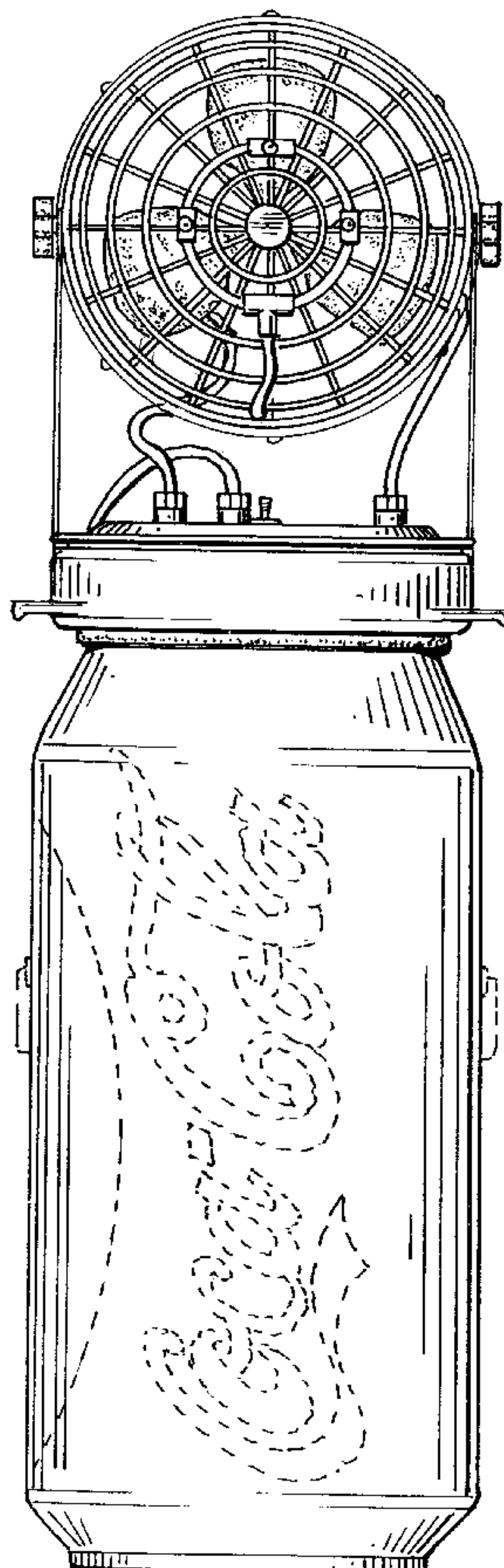

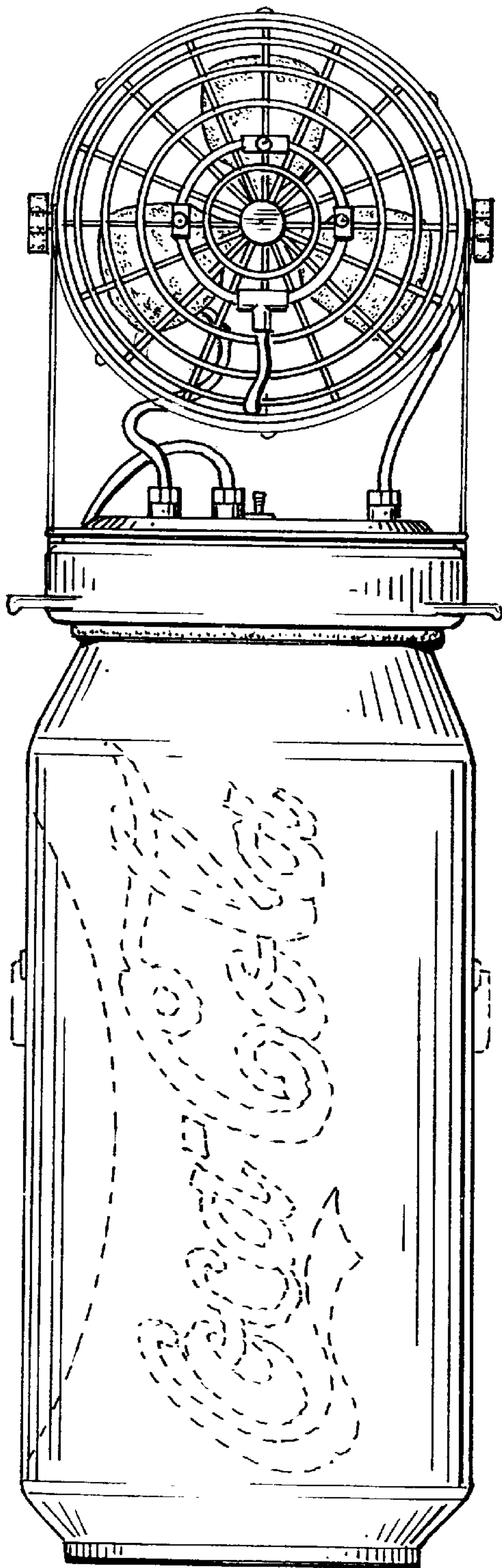

Fig. 1.

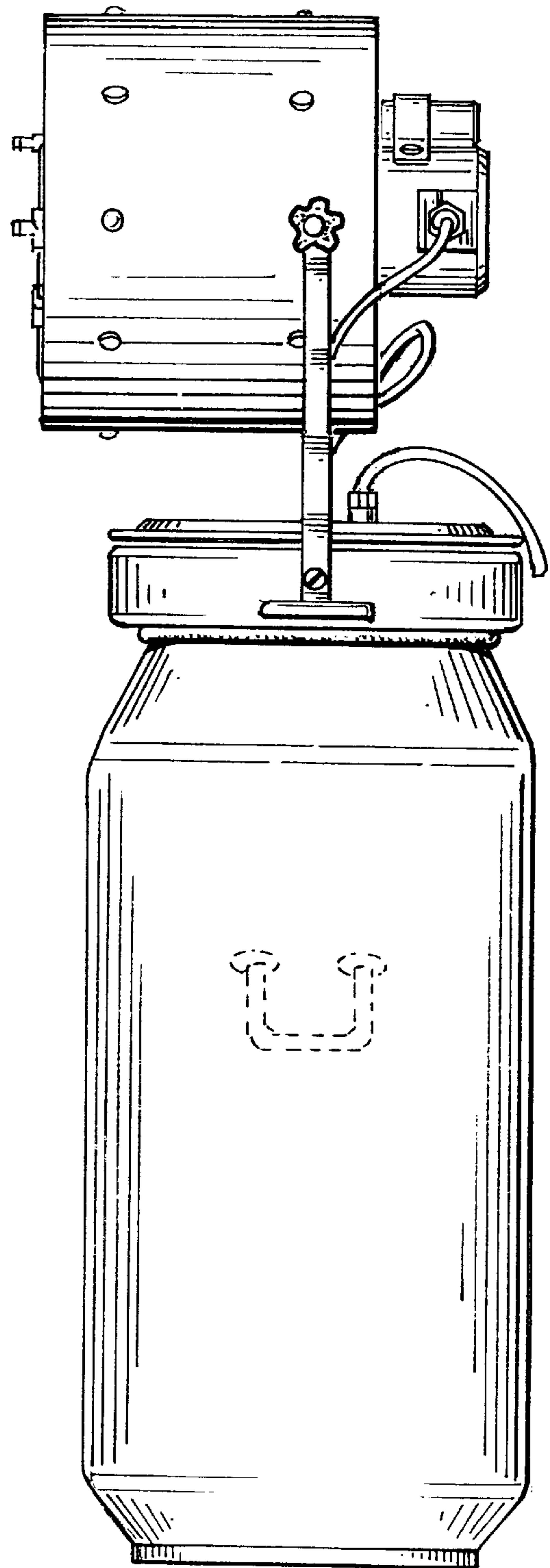

Fig. 2.

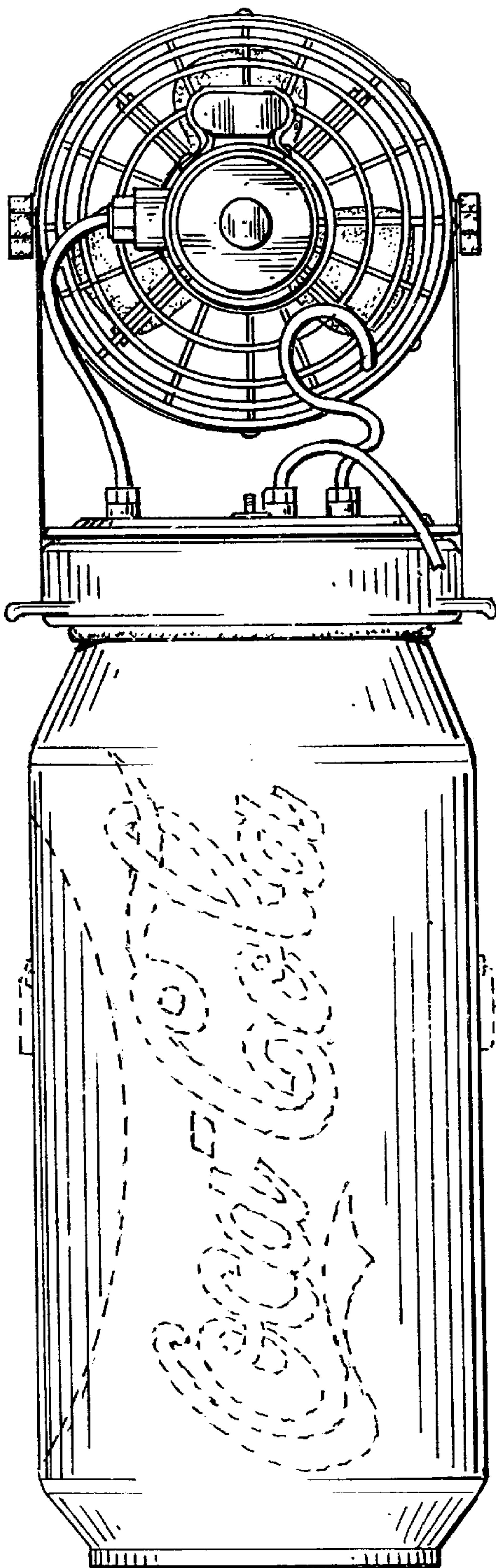

Fig. 3.

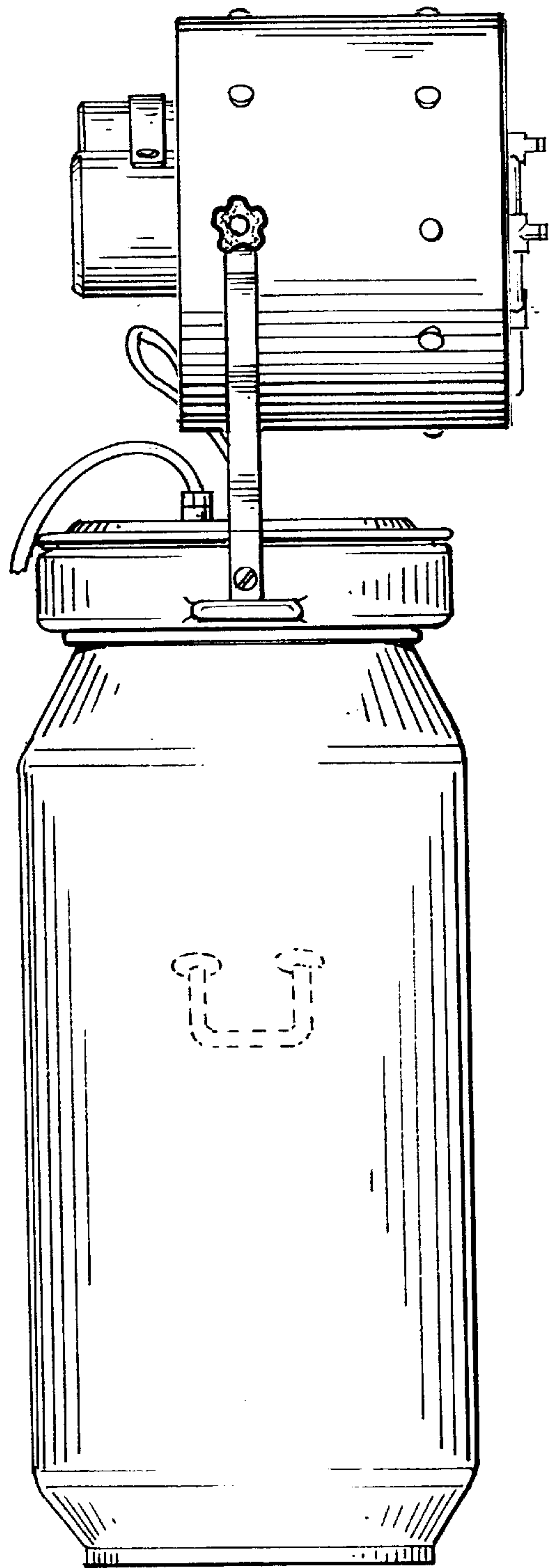

Fig. 4.

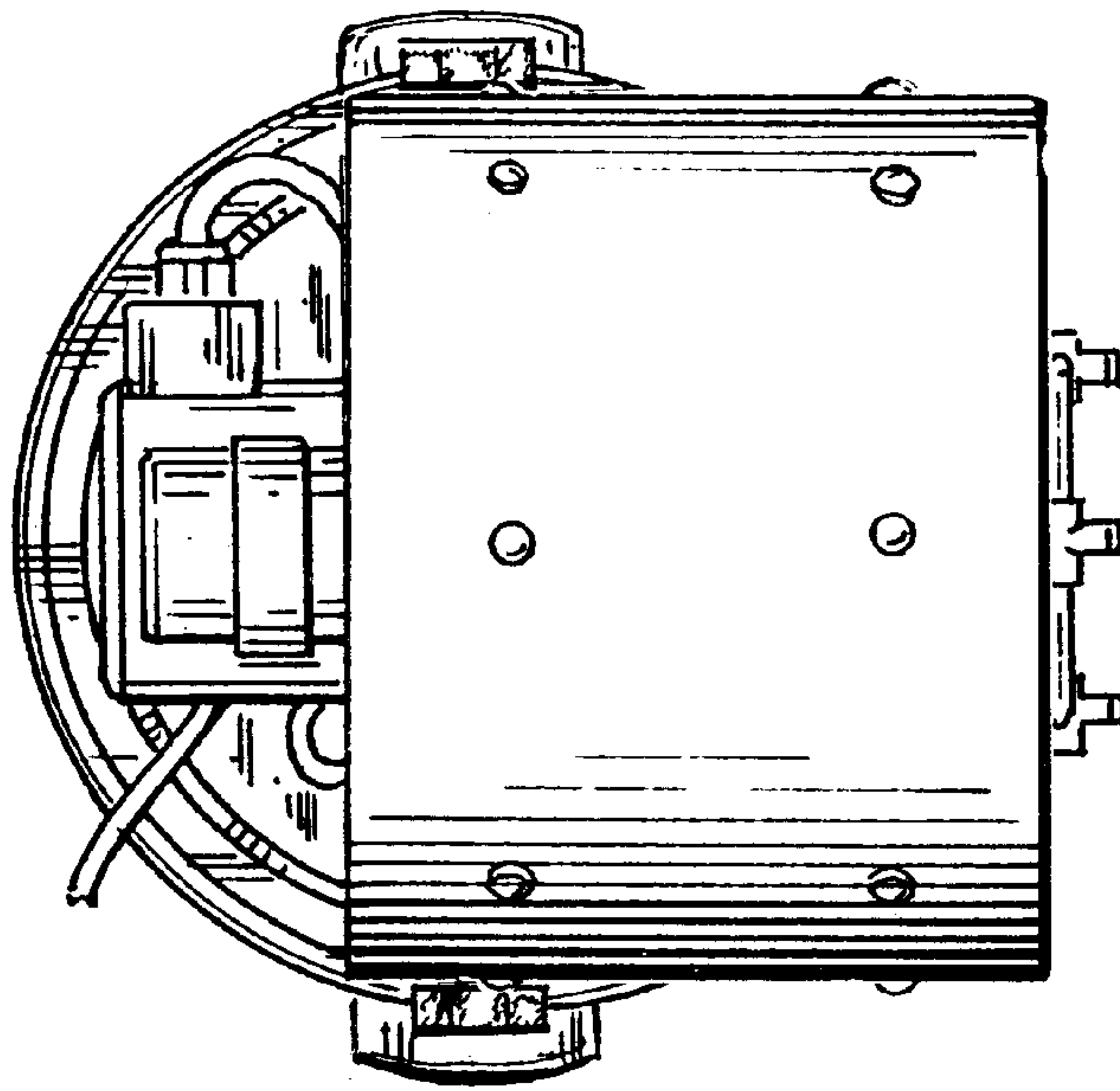

Fig. 5.

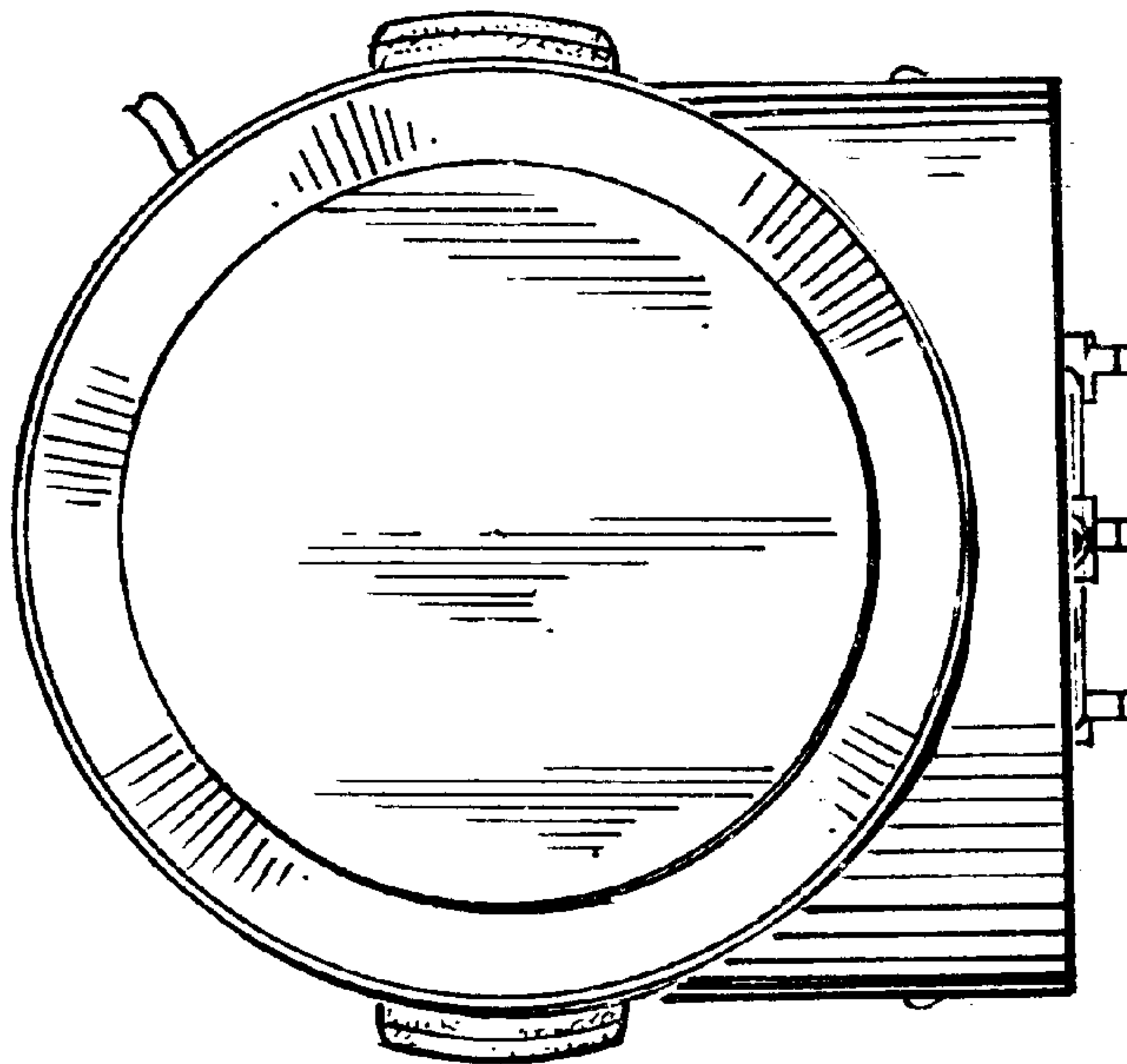

Fig. 6.

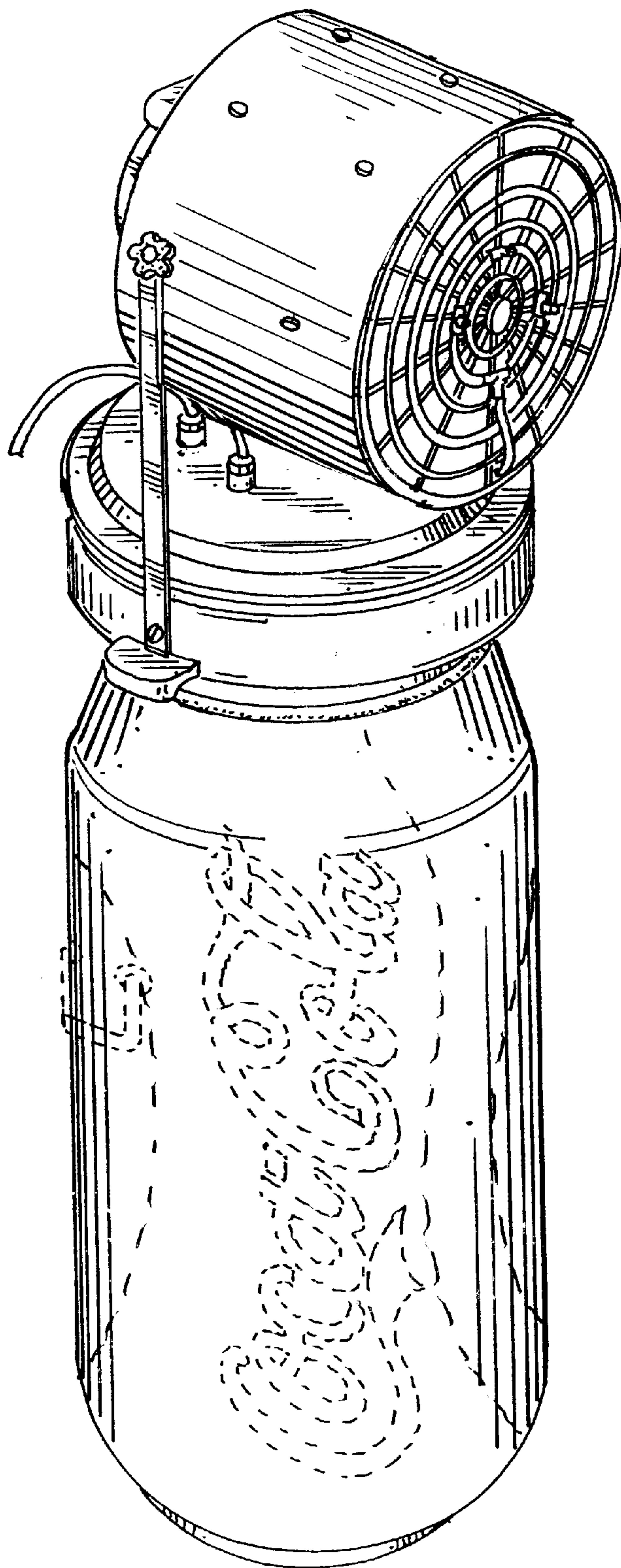

Fig. 1.