



US00D457537S

(12) **United States Design Patent**
Bond

(10) **Patent No.:** **US D457,537 S**

(45) **Date of Patent:** **** May 21, 2002**

(54) **OUTER SEGMENT OF CRUSHER ROLL**

5,954,282 A * 9/1999 Britzke et al. 241/275

(75) Inventor: **Neville James Bond**, Gisborne (AU)

FOREIGN PATENT DOCUMENTS

(73) Assignee: **Abon Engineering Pty. Ltd.** (AU)

AU 120003 4/1994
AU 120004 4/1994

(**) Term: **14 Years**

* cited by examiner

(21) Appl. No.: **29/145,693**

Primary Examiner—Antoine Duval Davis

(22) Filed: **Jul. 27, 2001**

(74) *Attorney, Agent, or Firm*—Baker Botts LLP

(30) **Foreign Application Priority Data**

(57) **CLAIM**

Jan. 29, 2001 (AU) 238/01

The ornamental design of an outer segment of crusher roll, as shown and described.

(51) **LOC (7) Cl.** **15-09**

DESCRIPTION

(52) **U.S. Cl.** **D15/123**

(58) **Field of Search** D15/123; 241/275,
241/293, 294, 300, 296, 297

FIG. 1 is a perspective view of an embodiment of an outer segment of crusher roll;

FIG. 2 is a left end view of the embodiment of FIG. 1;

FIG. 3 is a right end view of the embodiment of FIG. 1;

FIG. 4 is a front view of the embodiment of FIG. 1;

FIG. 5 is a rear view of the embodiment of FIG. 1; and,

FIG. 6 is a top view of the embodiment of FIG. 1.

(56) **References Cited**

U.S. PATENT DOCUMENTS

D254,256 S * 2/1980 Ackers et al. D15/123
D362,450 S * 9/1995 Bajadall D15/123
5,860,609 A * 1/1999 Sommer et al. 241/293

1 Claim, 1 Drawing Sheet

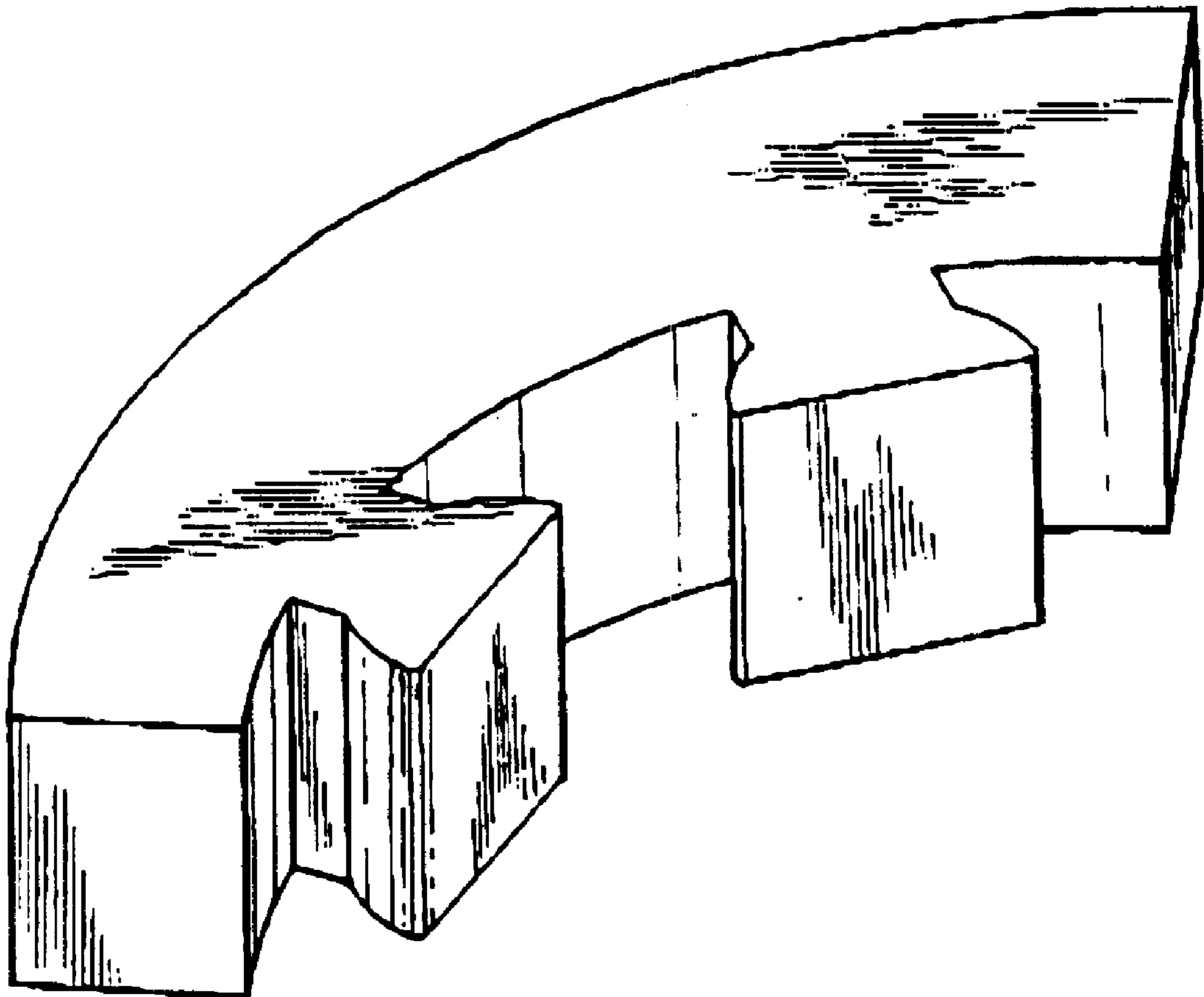

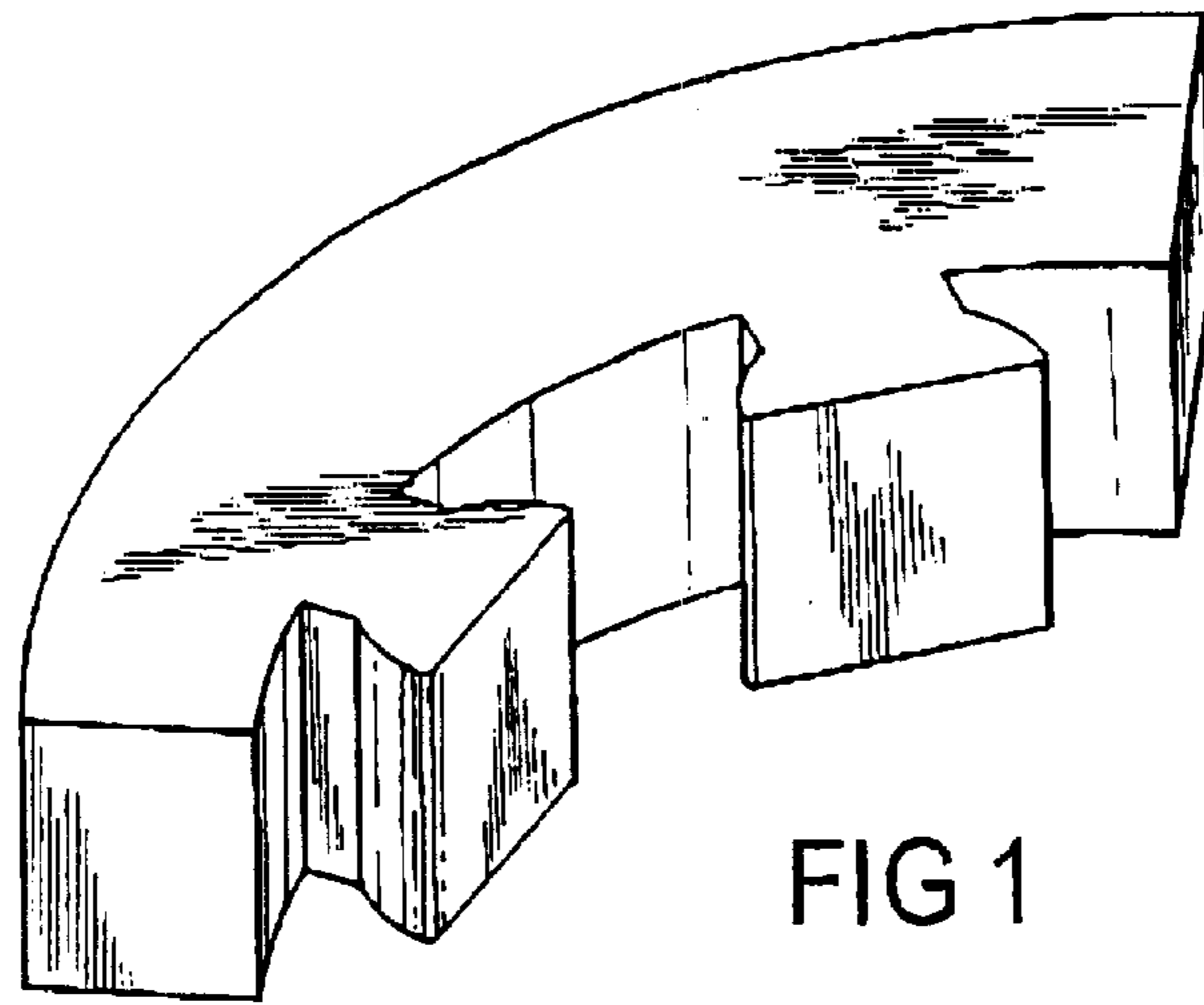

FIG 1

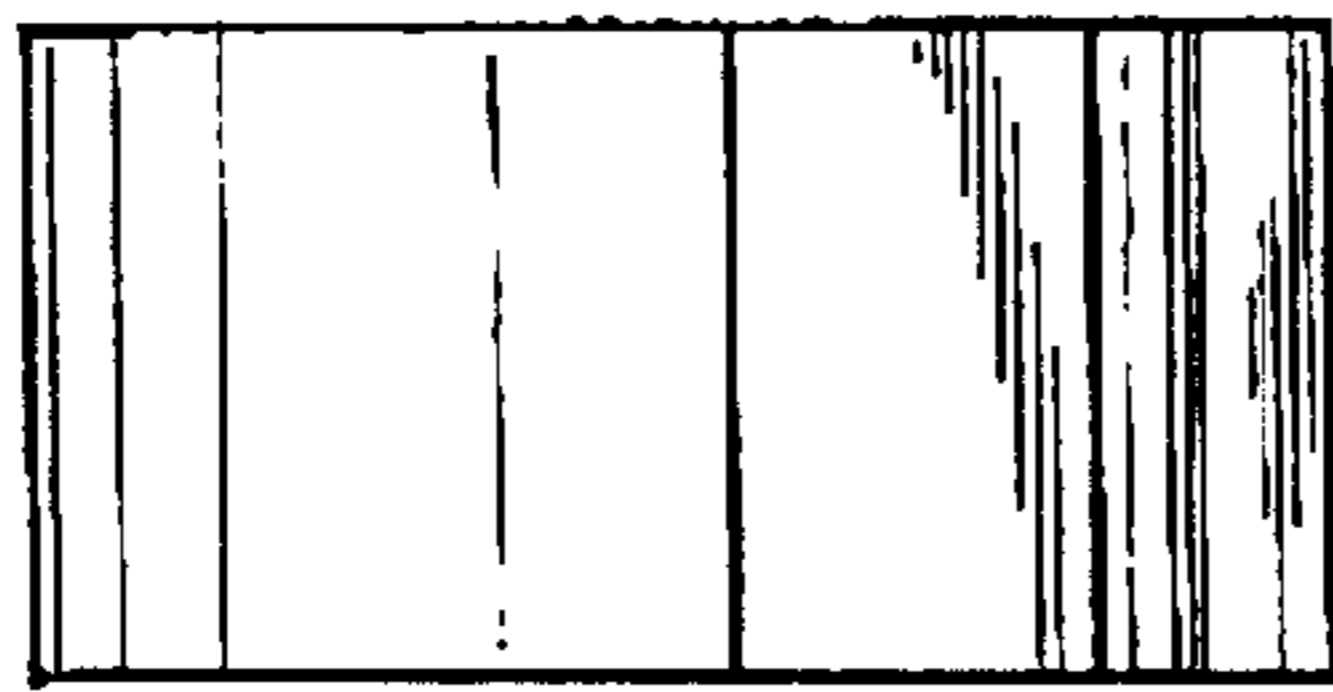

FIG 2

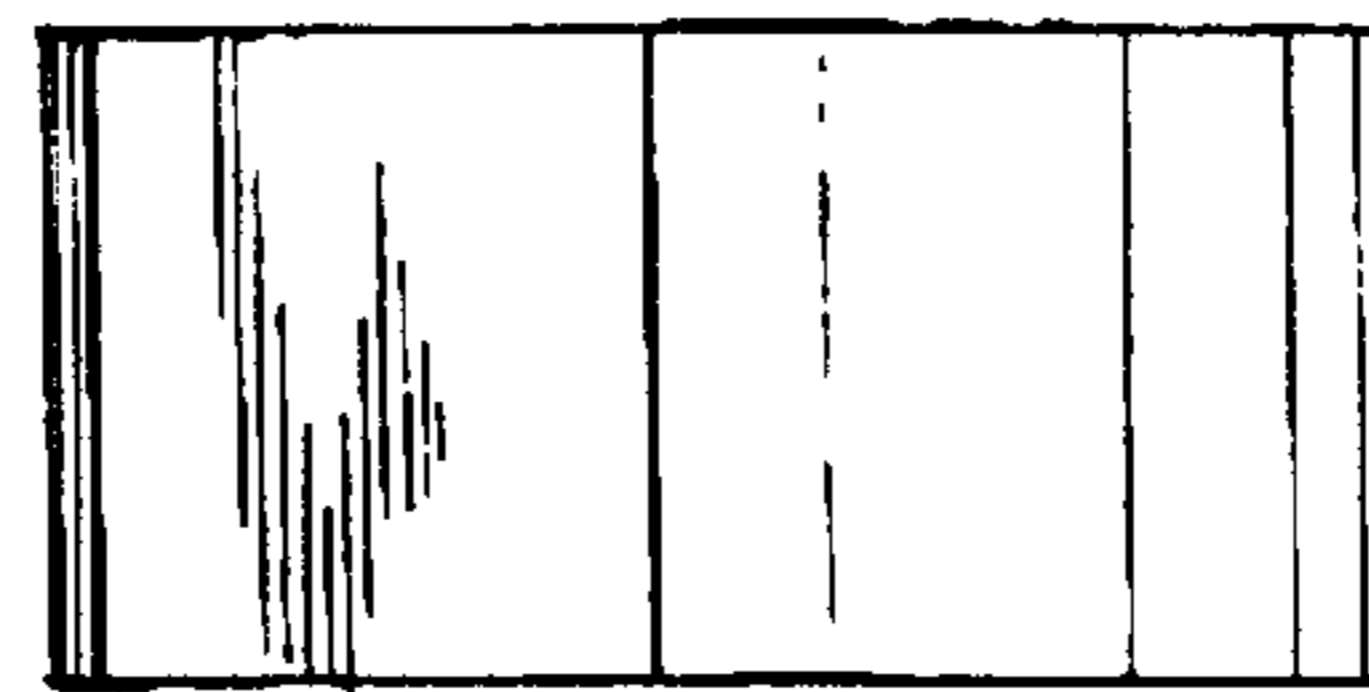

FIG 3

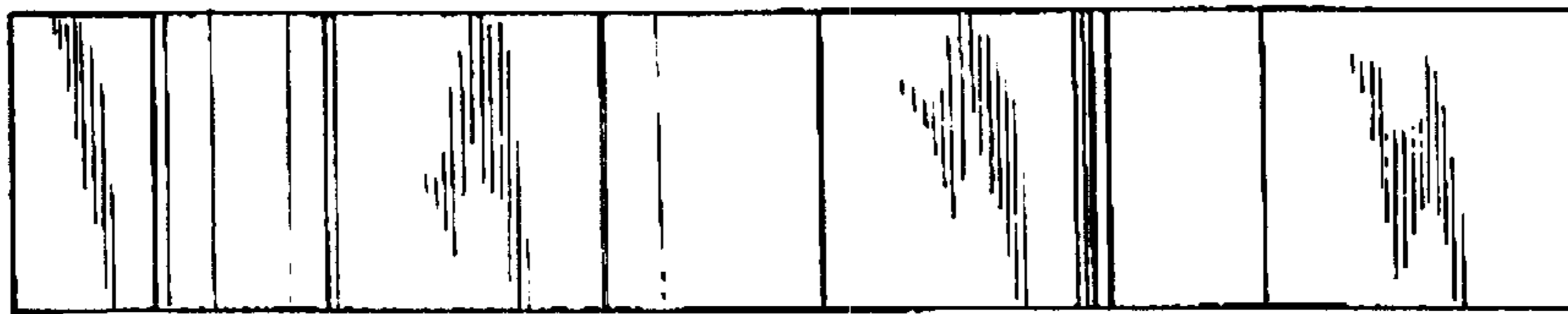

FIG 4

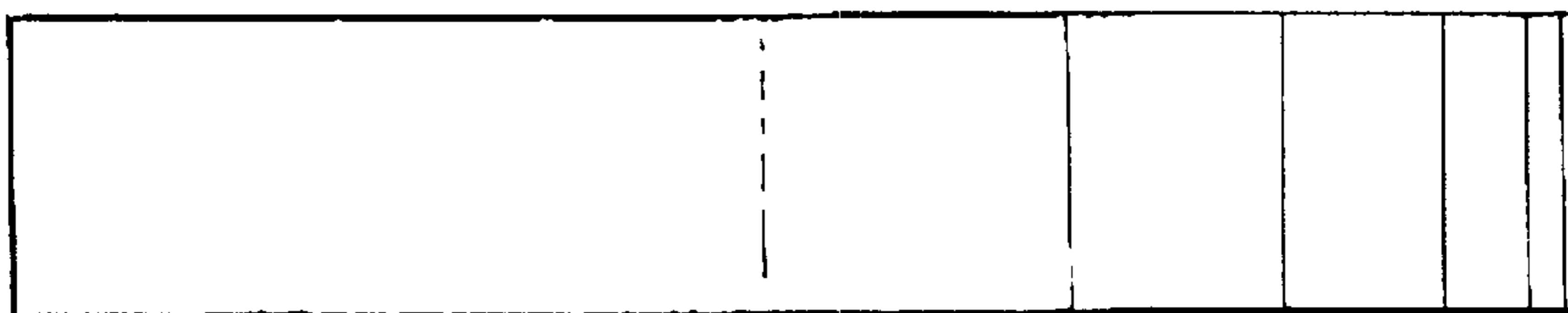

FIG 5

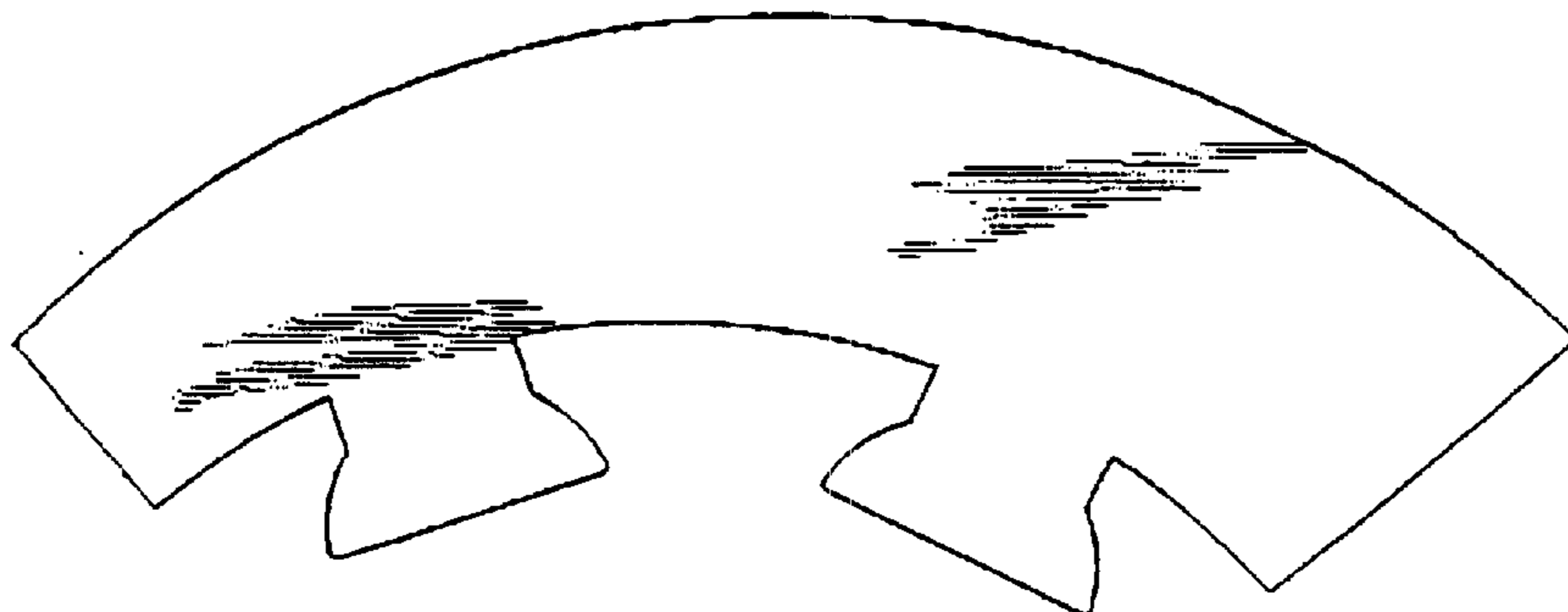

FIG 6