



US00D457516S

(12) **United States Design Patent**  
**Kohli et al.**

(10) **Patent No.:** **US D457,516 S**

(45) **Date of Patent:** **\*\* May 21, 2002**

(54) **RETRACTABLE HEADSET HOUSING**

D363,461 S \* 10/1995 Duckman et al. .... D13/154  
D368,581 S \* 4/1996 Cincotta ..... D3/218

(75) Inventors: **Paramjit Kohli**, Cranbourne (AU);  
**Seok-Ki Kim**, Goyang (KR)

\* cited by examiner

(73) Assignee: **FSL Electronics Pty Ltd.**, Cranbourne  
(AU)

*Primary Examiner*—Nanda Bondade

(74) *Attorney, Agent, or Firm*—Blumenfeld, Kaplan &  
Sandweiss, P.C.

(\*\*) Term: **14 Years**

(57) **CLAIM**

(21) Appl. No.: **29/136,016**

The ornamental design for a retractable headset housing, as shown and described.

(22) Filed: **Jan. 23, 2001**

**DESCRIPTION**

(51) **LOC (7) Cl.** ..... **14-01**

(52) **U.S. Cl.** ..... **D14/224; D3/218**

(58) **Field of Search** ..... D3/218; D13/154;  
D14/188, 192, 205–206, 223; 181/129–130,  
135, 382; 379/430–431, 433; 381/182,  
370, 376–381, 384; 455/350–351, 344

FIG. 1 is an isometric view of the retractable headset housing showing our new design;

FIG. 2 is a front elevational view thereof;

FIG. 3 is a rear elevational view thereof;

FIG. 4 is a left side elevational view thereof;

FIG. 5 is a right side elevational view thereof;

FIG. 6 is a top plan view thereof; and,

FIG. 7 is a bottom plan view thereof.

The broken lines in FIG. 1, showing the earphone/headset and the coiled phone jack cord are for illustrative purposes only and form no part of the claimed design.

(56) **References Cited**

**U.S. PATENT DOCUMENTS**

- 3,984,645 A \* 10/1976 Kresch ..... 379/430
- 4,942,617 A \* 7/1990 Boylan ..... 381/182
- D314,964 S \* 2/1991 Chung ..... D14/192
- 5,161,250 A \* 11/1992 Ianna et al. .... 455/344

**1 Claim, 1 Drawing Sheet**

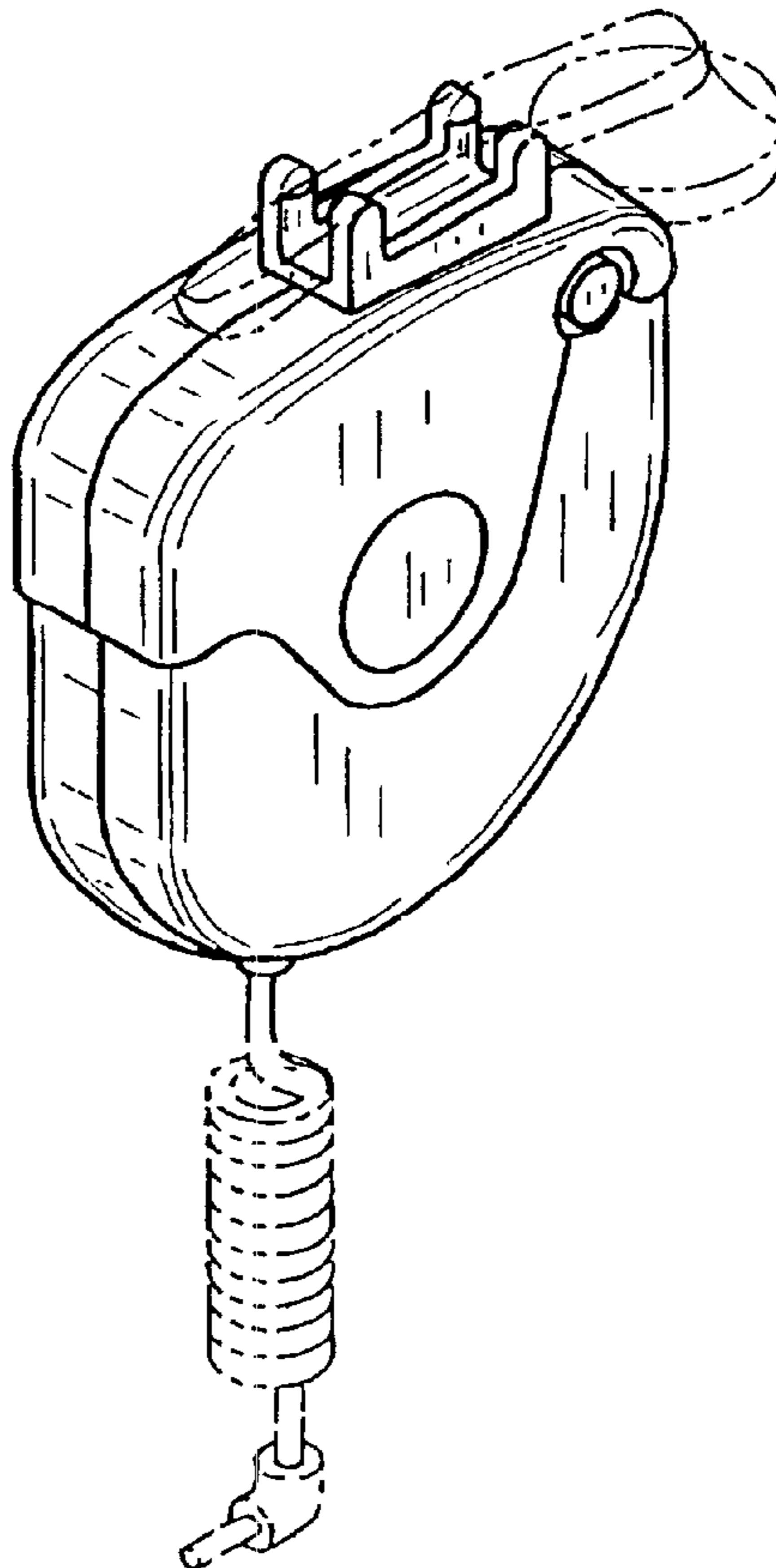

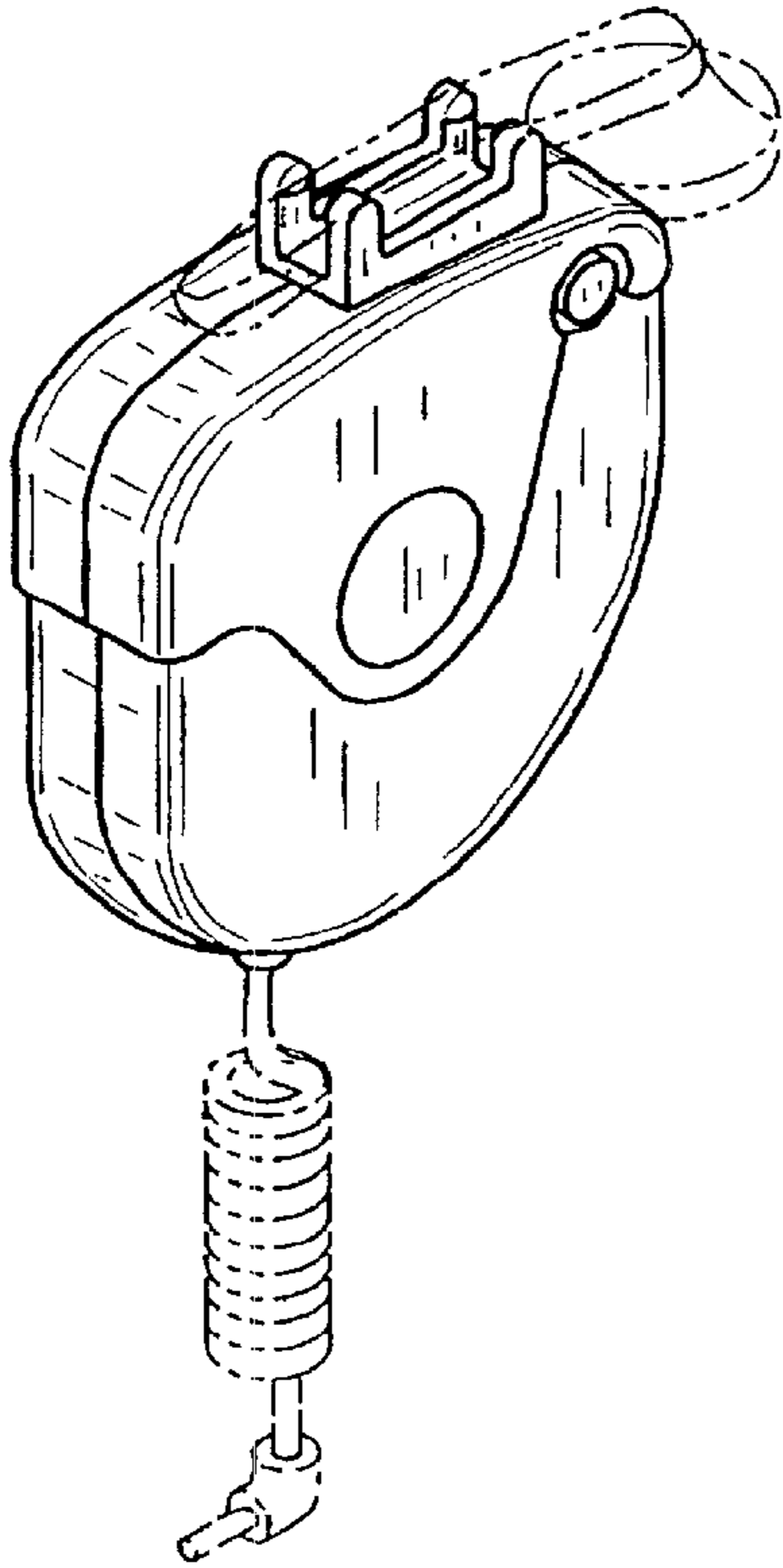

FIG. 1

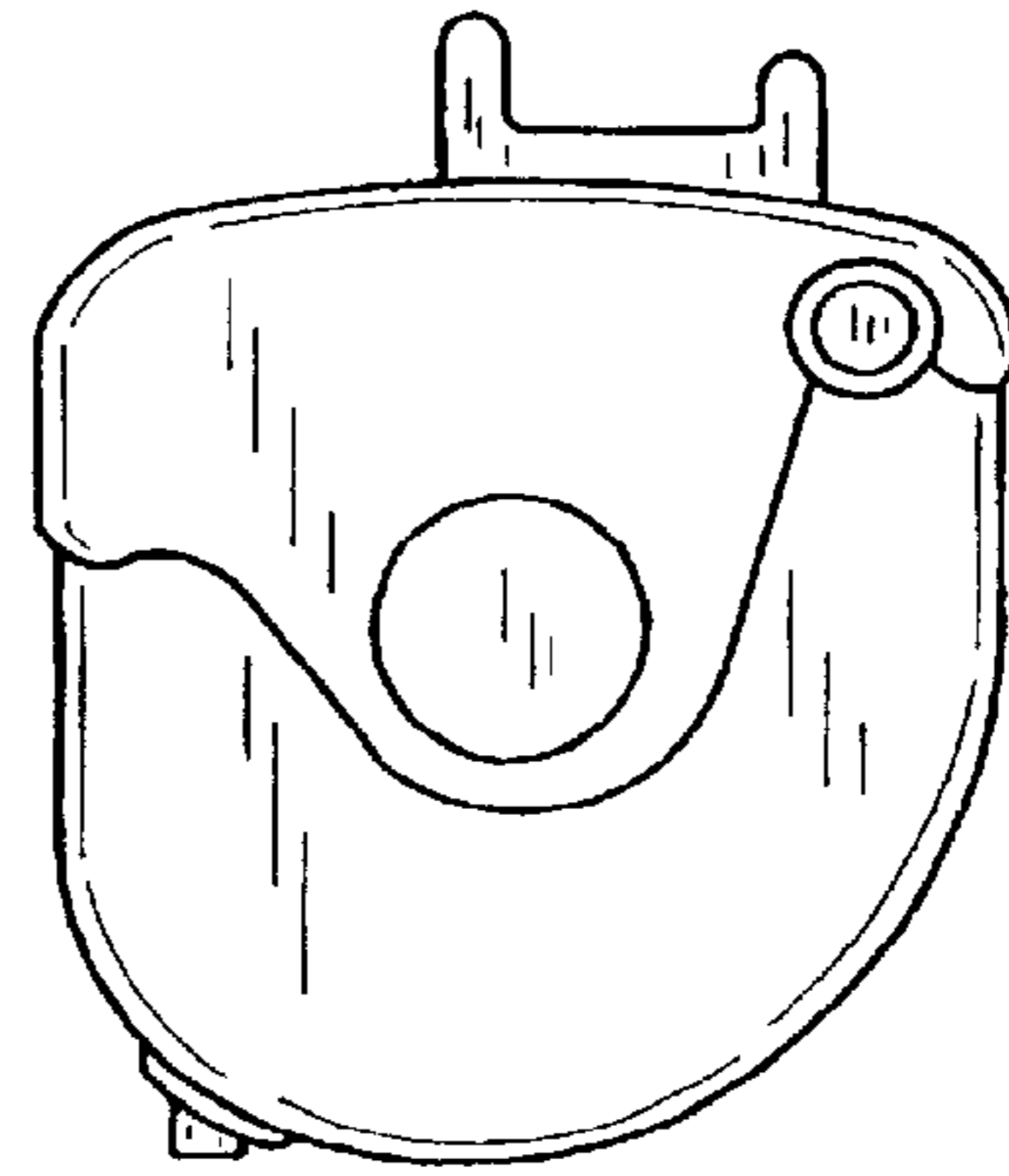

FIG. 2

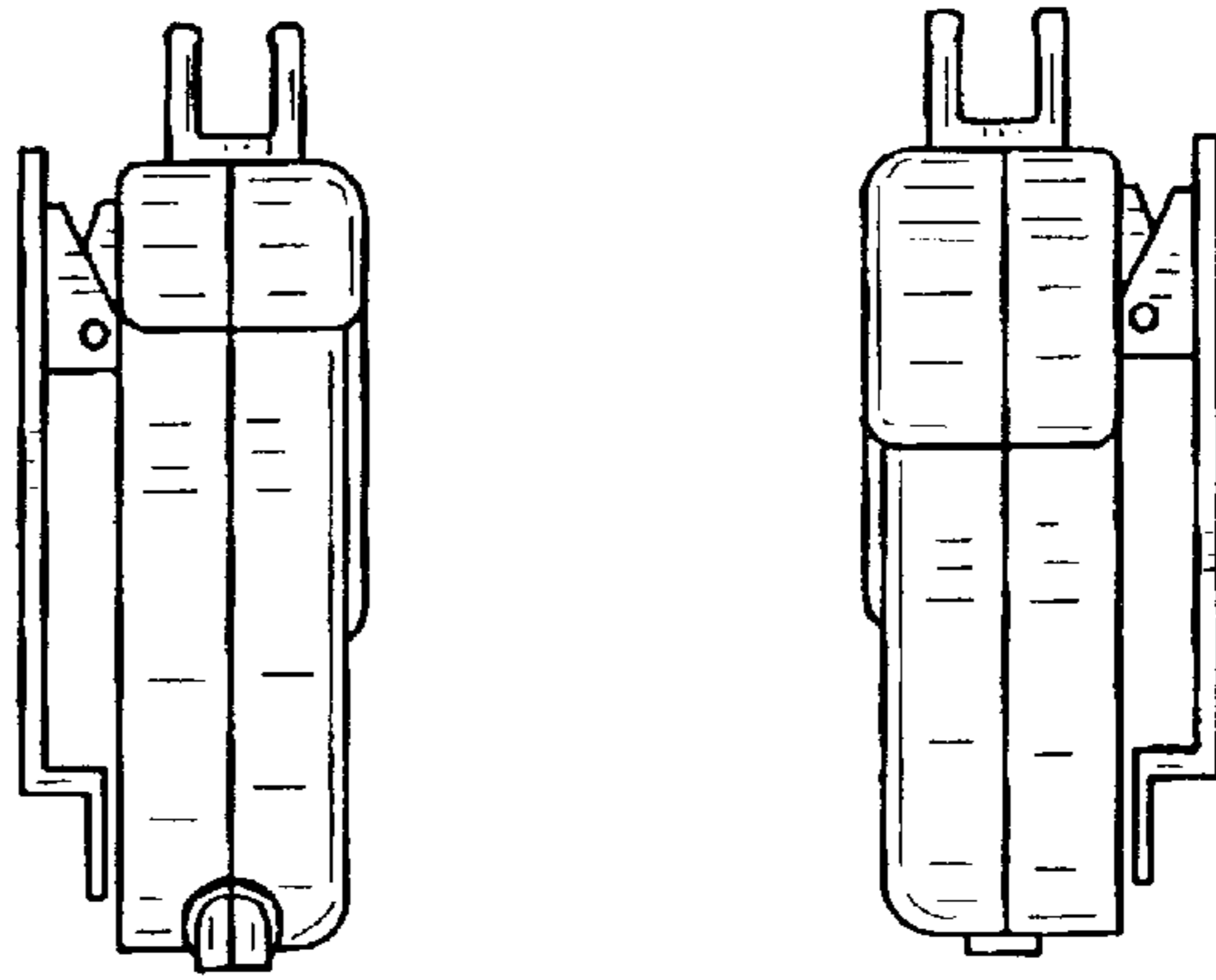

FIG. 4 FIG. 5

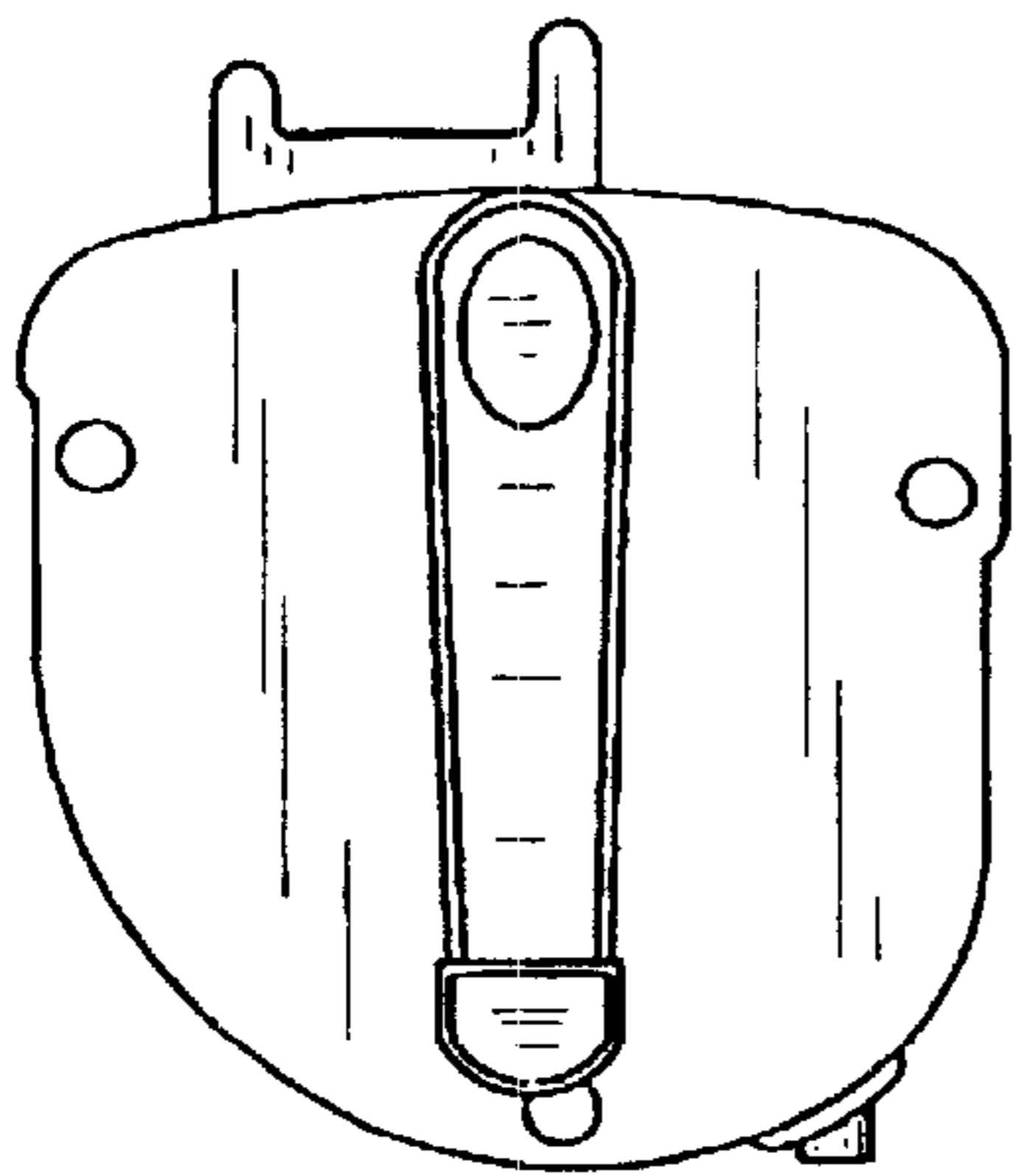

FIG. 3

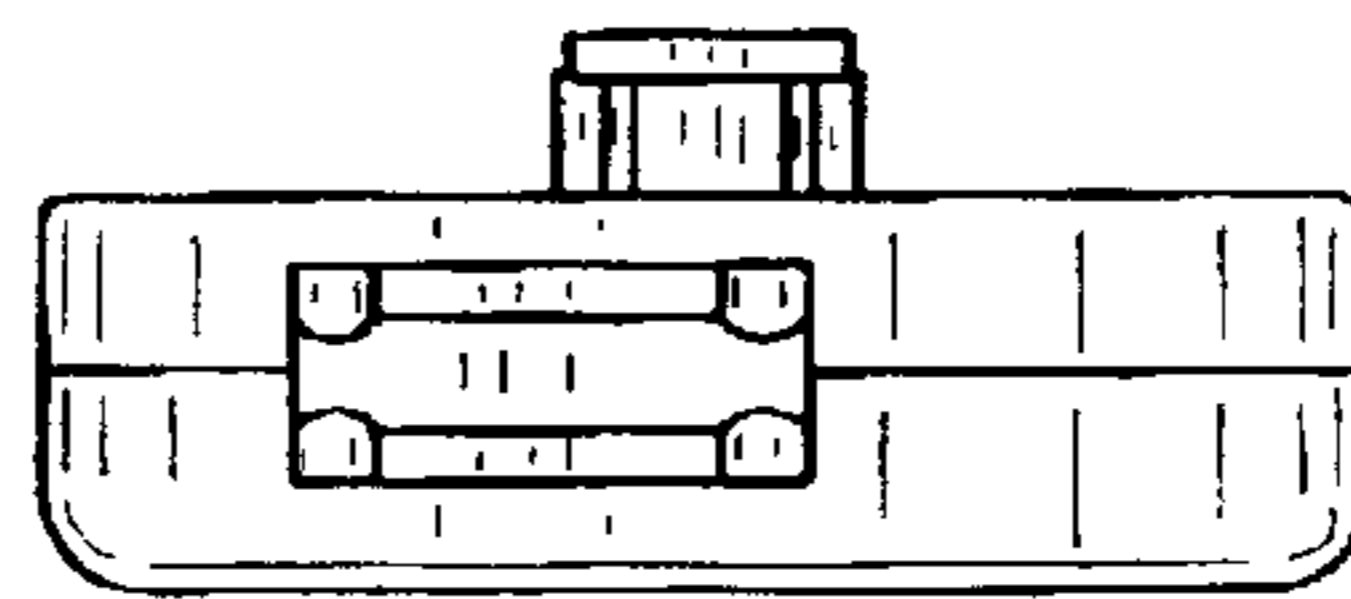

FIG. 6

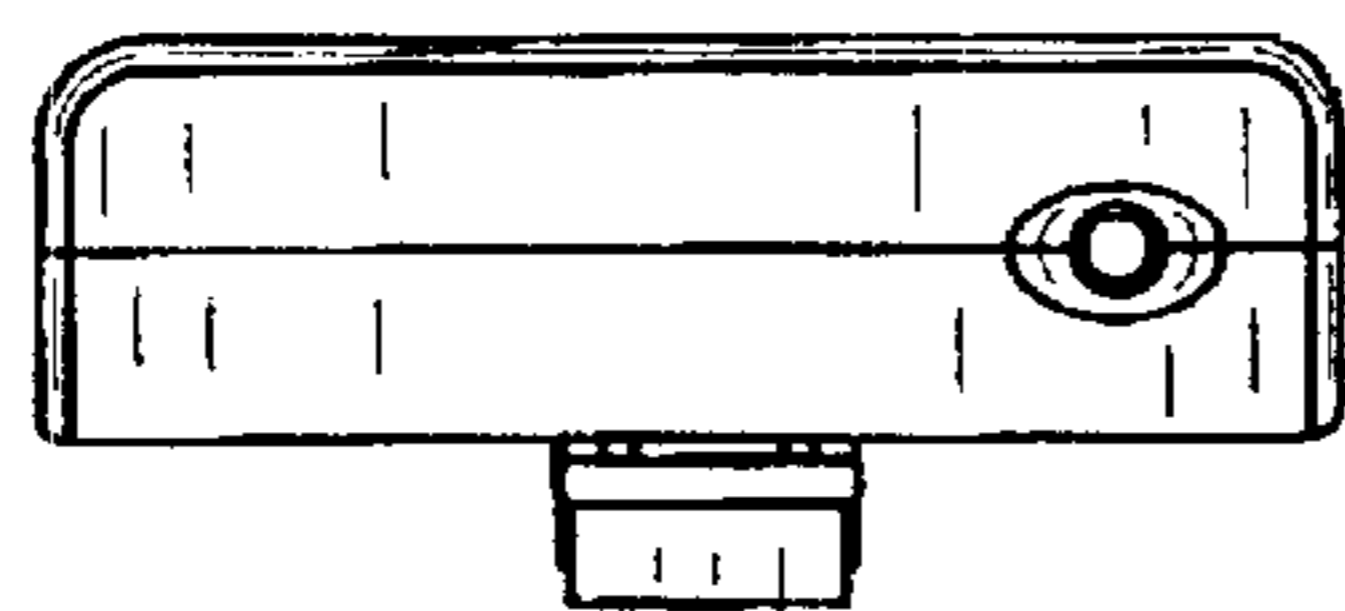

FIG. 7