



US00D457387S

(12) **United States Design Patent**
Coudurier

(10) **Patent No.:** **US D457,387 S**

(45) **Date of Patent:** **** May 21, 2002**

(54) **HANDLE**

(75) **Inventor:** **Olivier Coudurier**, Marigny St. Marcel (FR)

(73) **Assignee:** **Tefal S.A.**, Rumilly (FR)

(**) **Term:** **14 Years**

(21) **Appl. No.:** **29/139,787**

(22) **Filed:** **Apr. 6, 2001**

(30) **Foreign Application Priority Data**

Oct. 6, 2000 (FR) 00 5820

(51) **LOC (7) Cl.** **07-02**

(52) **U.S. Cl.** **D7/394**

(58) **Field of Search** D7/393-395, 354-361;
16/430, 431, 110.1; D8/300, 307; 220/752,
753, 759

(56) **References Cited**

U.S. PATENT DOCUMENTS

D344,430 S * 2/1994 Raoult D7/394

D391,444 S * 3/1998 Munari D7/394

D416,172 S * 11/1999 Cheng D7/394

D433,273 S * 11/2000 Roussard D7/358

* cited by examiner

Primary Examiner—Terry A. Wallace

(74) *Attorney, Agent, or Firm*—Young & Thompson

(57) **CLAIM**

The ornamental design for a handle, as shown and described.

DESCRIPTION

FIG. 1 is a top and side perspective view of a handle showing my new design;

FIG. 2 is a side elevational view thereof, the side opposite that shown in FIG. 2 being the mirror image thereof;

FIG. 3 is a side elevational view thereof taken from the left of FIG. 2;

FIG. 4 is a side elevational view thereof from the right of FIG. 2;

FIG. 5 is a top plan view thereof; and,

FIG. 6 is a bottom plan view thereof.

1 Claim, 6 Drawing Sheets

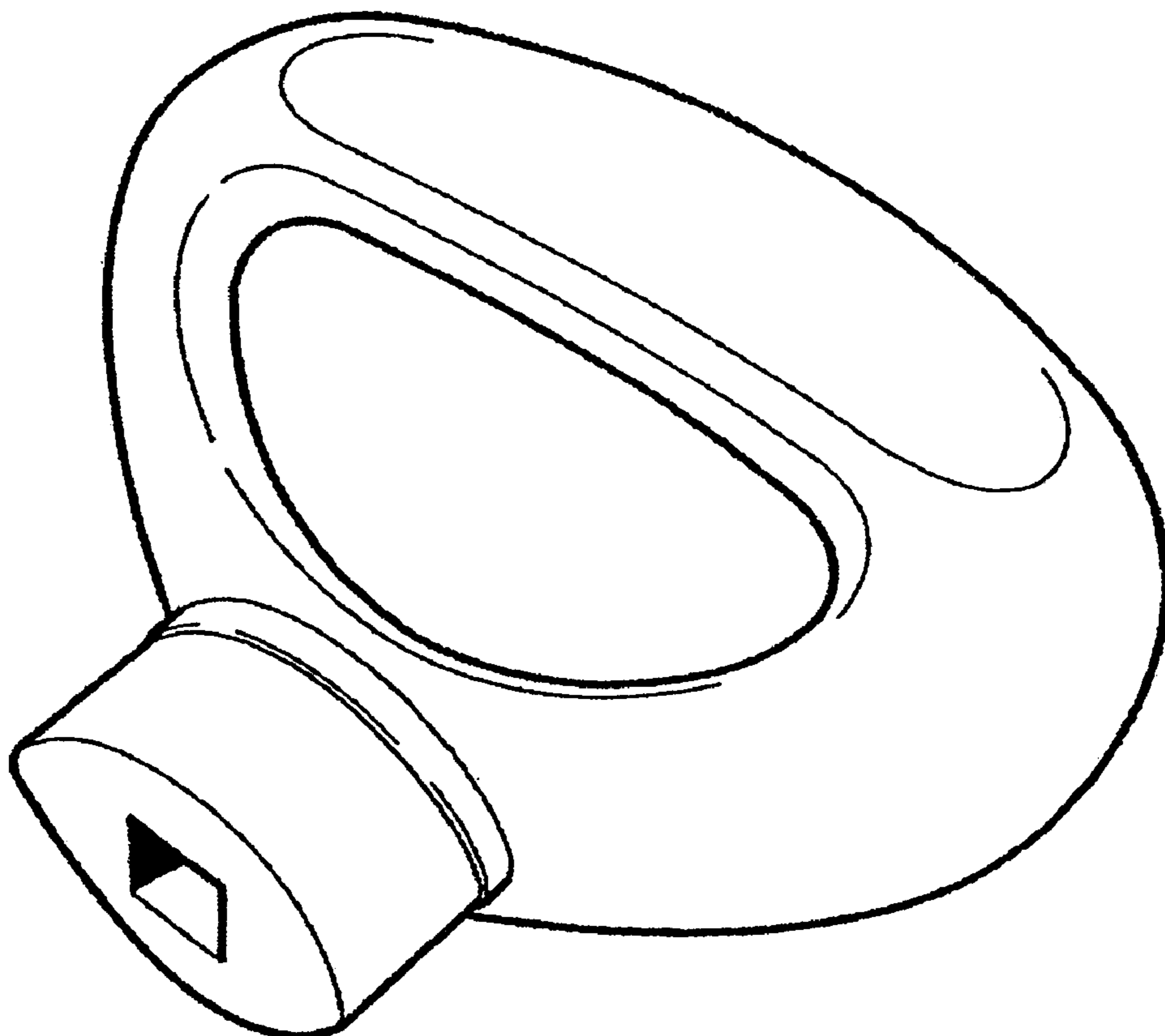

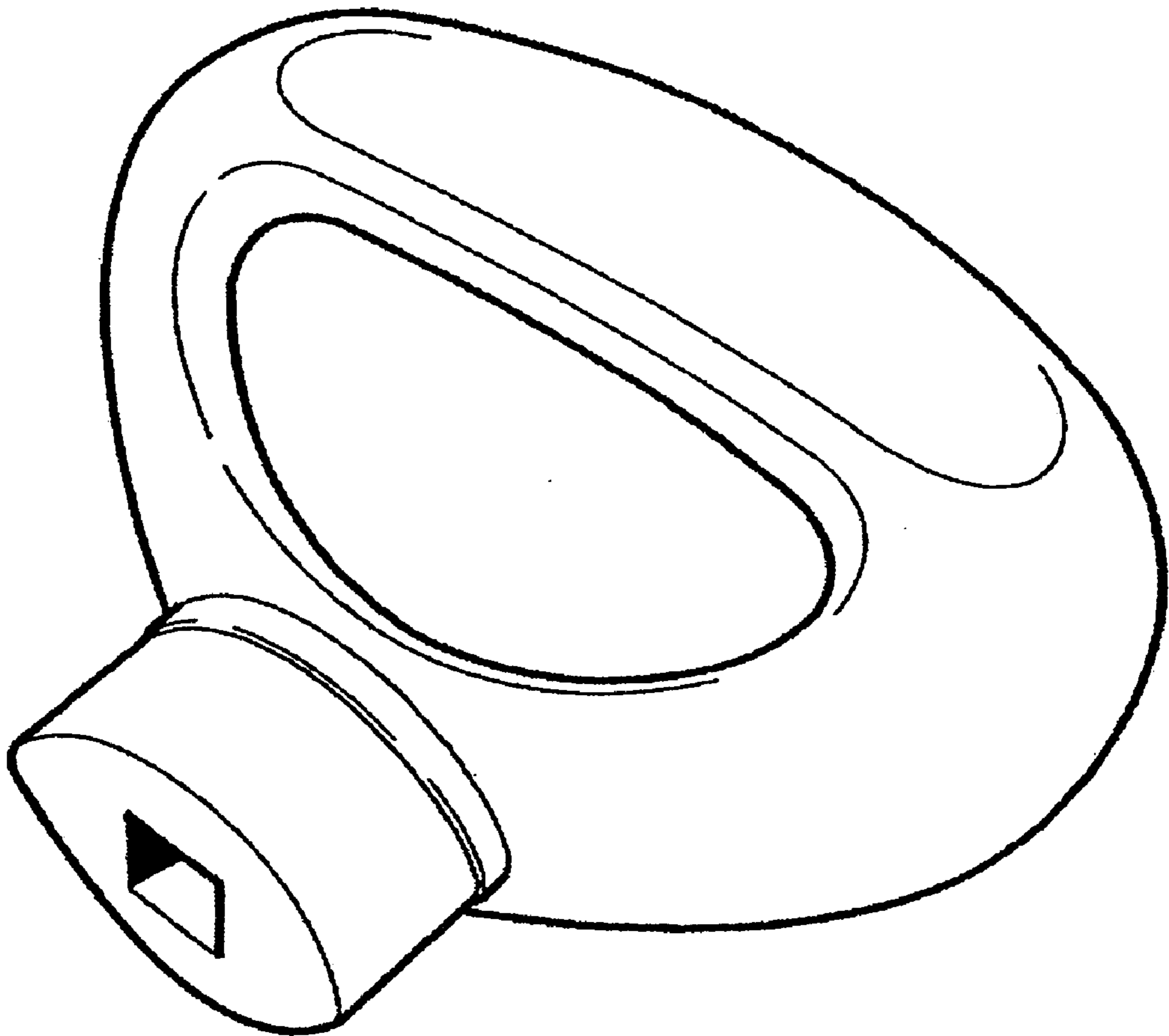

Fig. 1

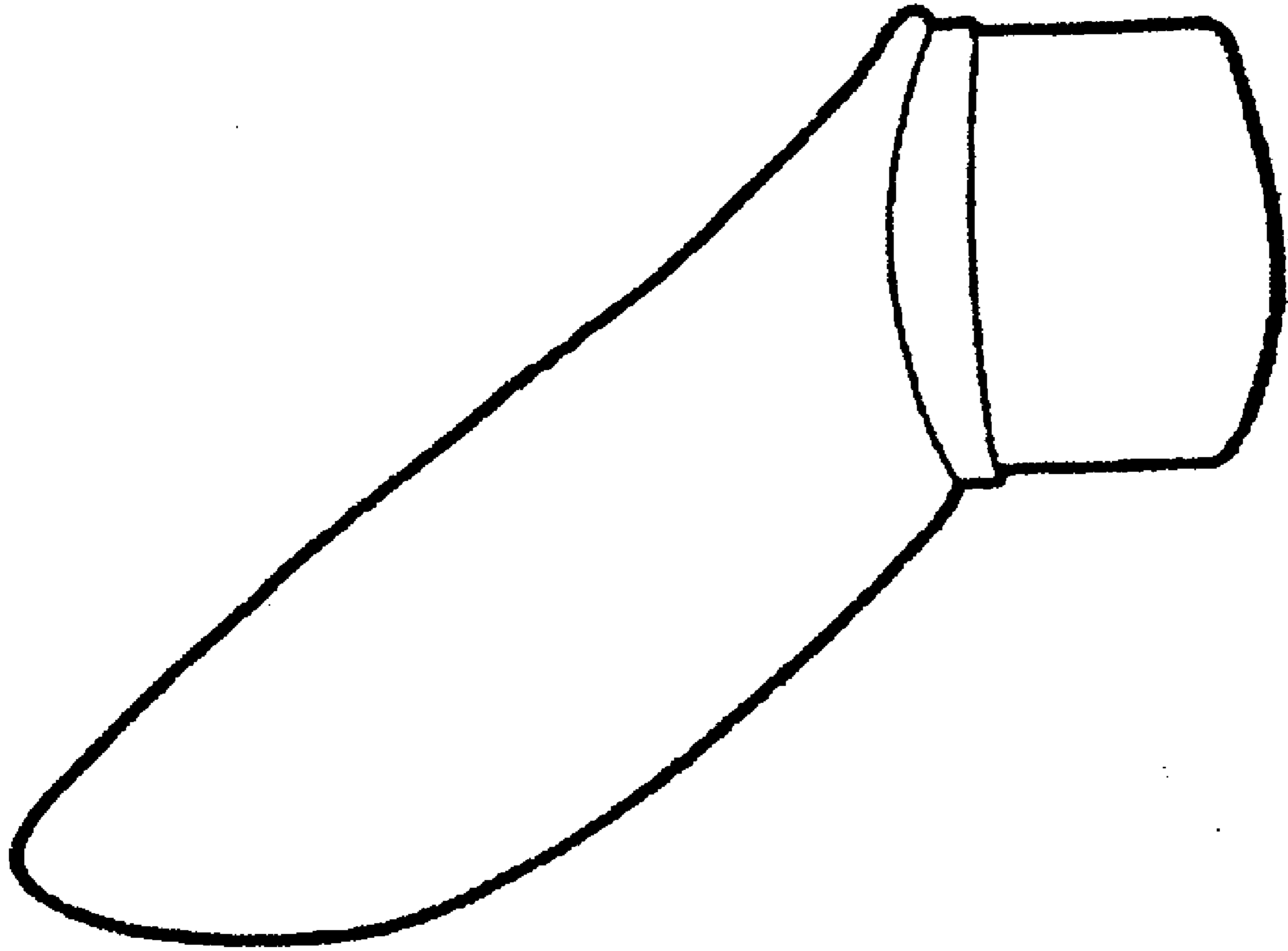

Fig. 2

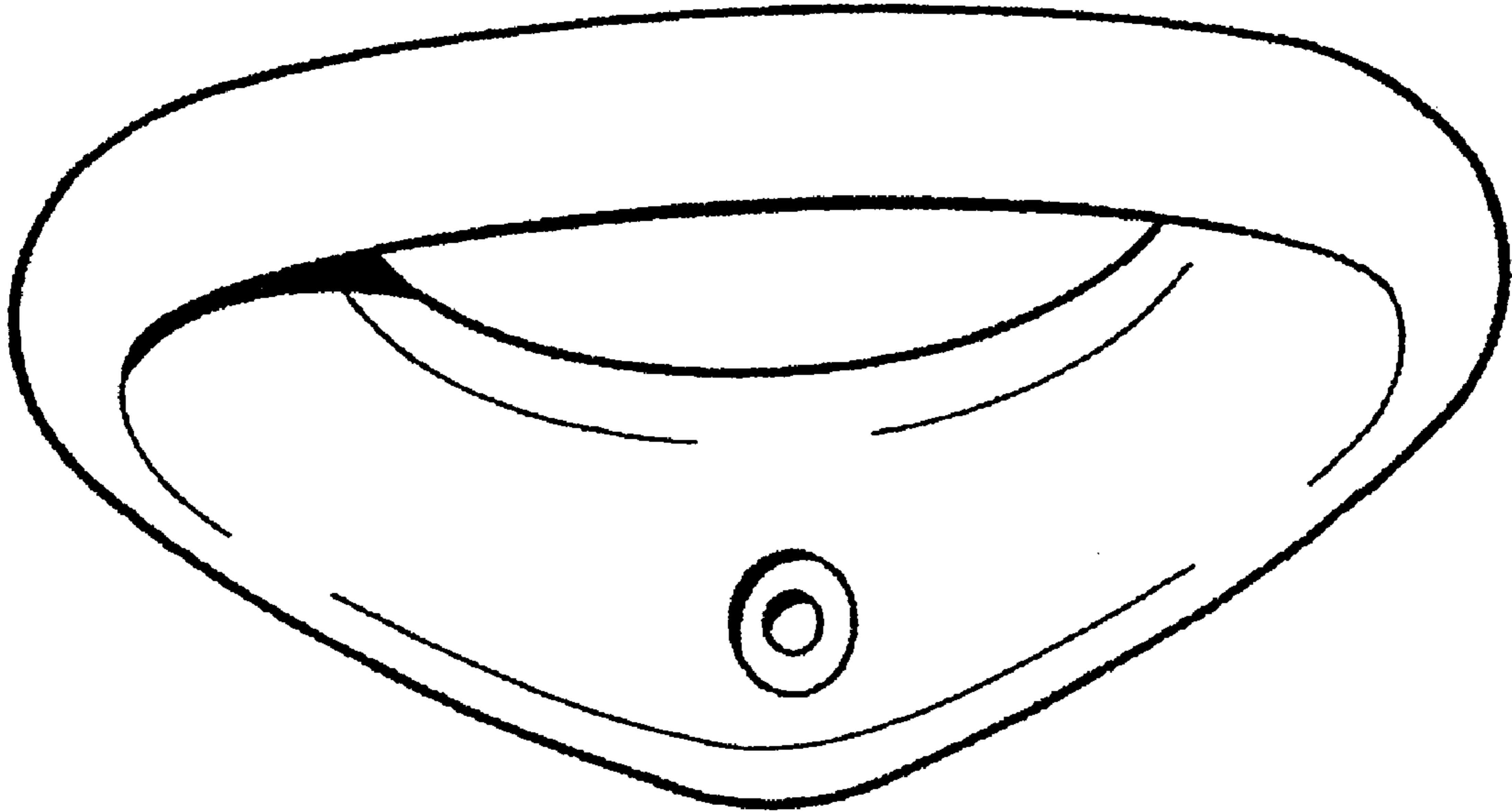

Fig. 3

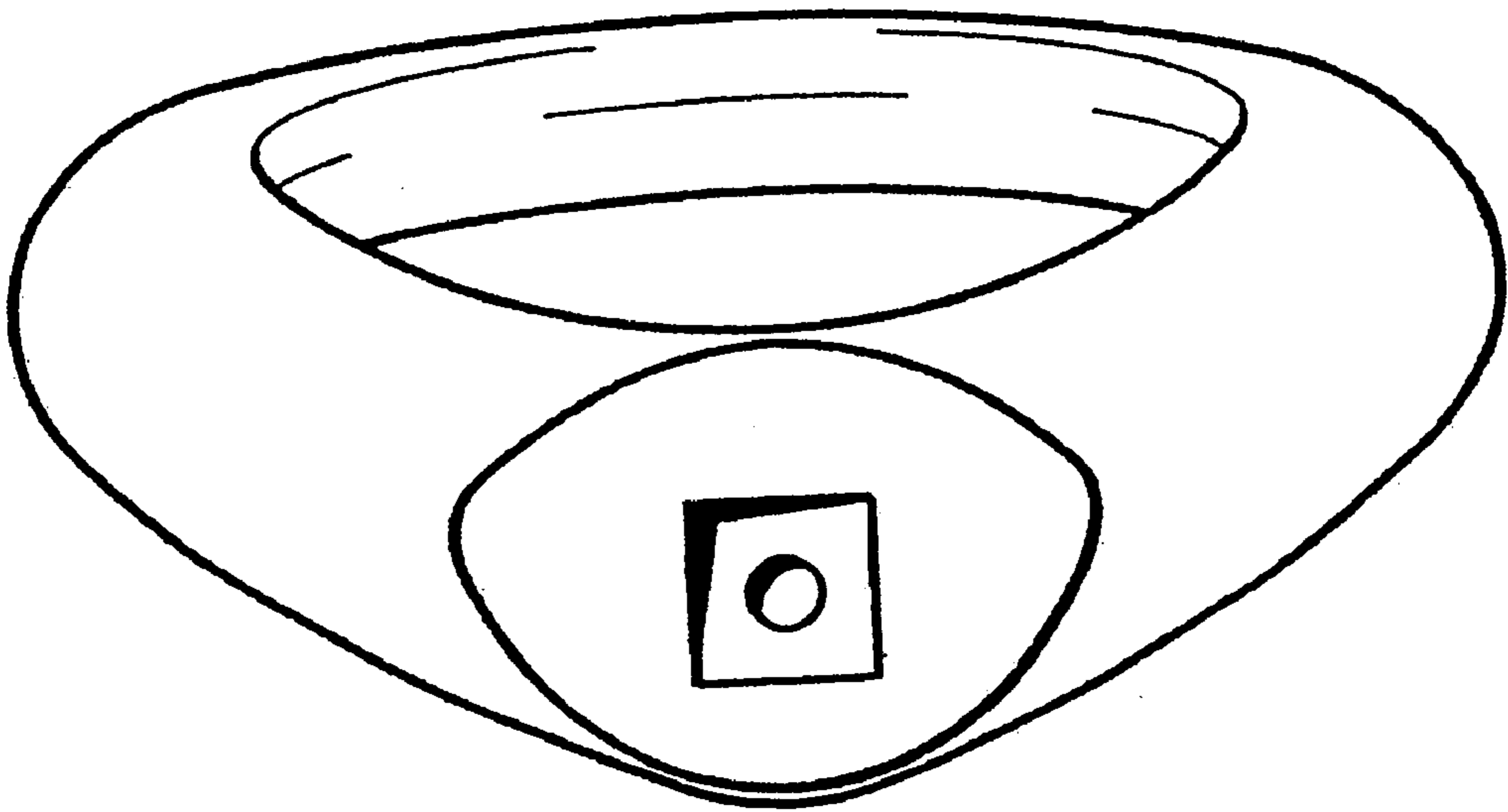

Fig. 4

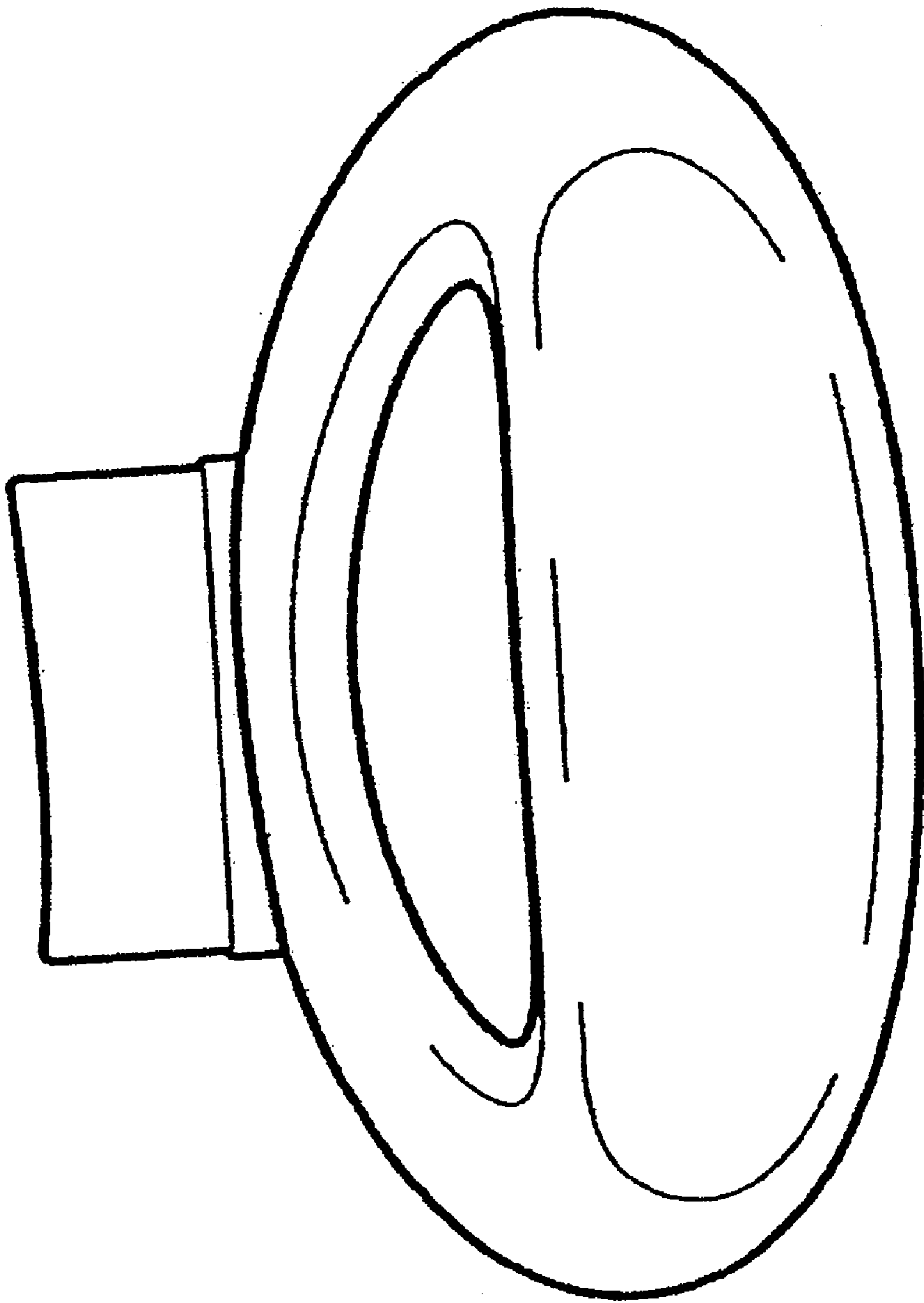

Fig. 5

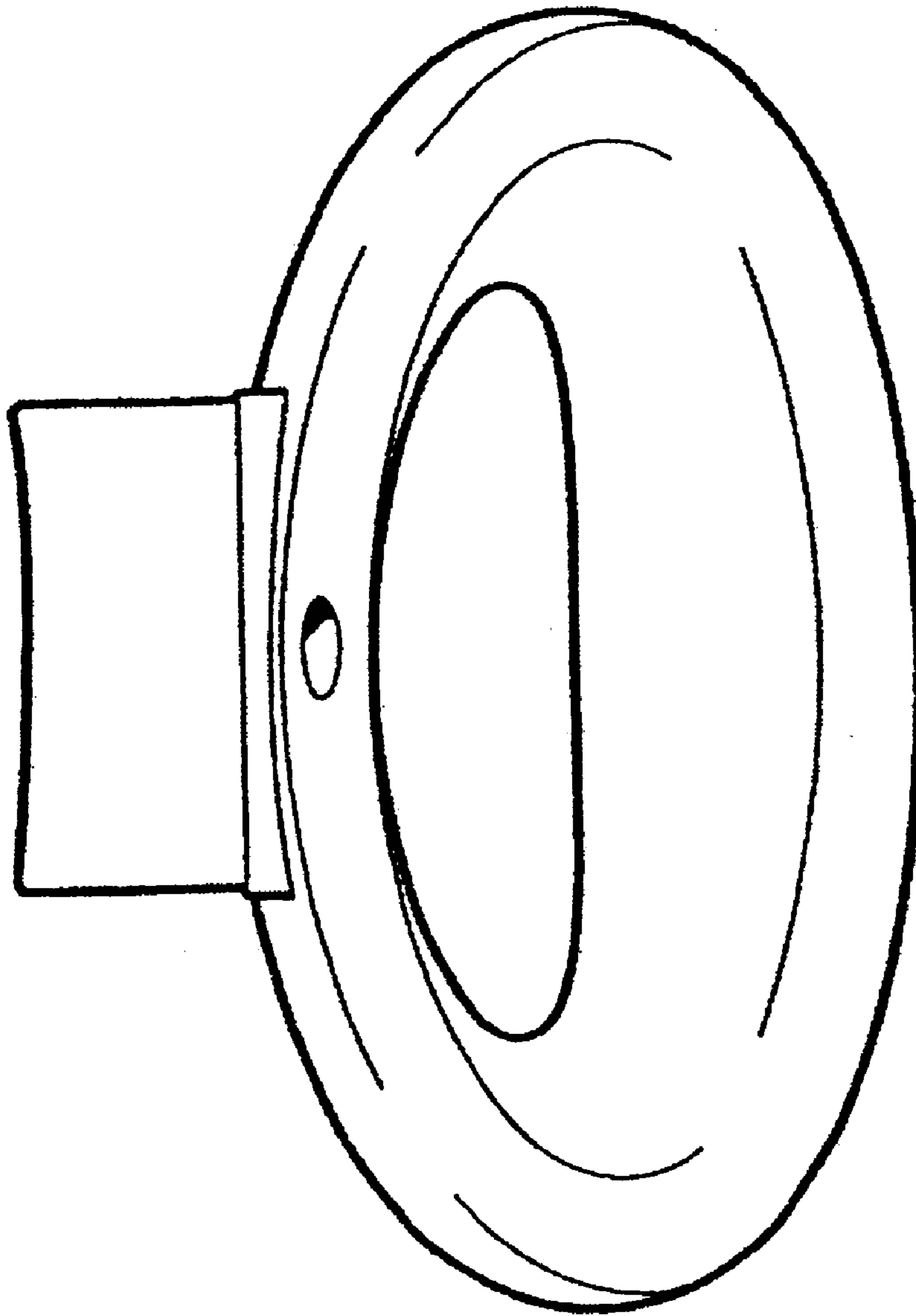

Fig. 6