



US00D457369S

(12) **United States Design Patent** (10) **Patent No.:** **US D457,369 S**
Fiscus et al. (45) **Date of Patent:** **** May 21, 2002**

(54) **GUN BARREL REST**

(75) Inventors: **Jon Fiscus; Shelley Nehrt**, both of Barrington; **Dave Story**, Bartlett, all of IL (US)

(73) Assignee: **Stack-On Products Co.**, Wauconda, IL (US)

(**) Term: **14 Years**

(21) Appl. No.: **29/135,776**

(22) Filed: **Jan. 16, 2001**

(51) **LOC (7) Cl.** **02-08**

(52) **U.S. Cl.** **D6/552**

(58) **Field of Search** D6/552, 553, 567, D6/569; D22/109; 211/64

(56) **References Cited**

U.S. PATENT DOCUMENTS

D365,717 S	*	1/1996	Cardenas	D6/552
D372,616 S	*	8/1996	Cute	D6/552
D381,852 S	*	8/1997	Cardenas	D6/552
D392,142 S	*	3/1998	Weisburn et al.	D6/567

* cited by examiner

Primary Examiner—Brian N. Vinson

(74) *Attorney, Agent, or Firm*—Patzik, Frank & Samotny Ltd.

(57) **CLAIM**

The ornamental design for the gun barrel rest, as shown and described.

DESCRIPTION

FIG. 1 is a front perspective view of a first embodiment of a gun barrel rest showing the new ornamental design thereof;

FIG. 2 is a rear perspective view thereof;

FIG. 3 is a front plan view thereof;

FIG. 4 is a rear plan view thereof;

FIG. 5 is a top elevational plan view thereof, the bottom elevational plan view being identical thereto; and

FIG. 6 is a left side elevational plan view of the first through fourth embodiments, the right side elevational plan view being identical thereto;

FIG. 7 is a front perspective view of a second embodiment of a gun barrel rest showing the new ornamental design thereof;

FIG. 8 is a rear perspective view thereof;

FIG. 9 is a front plan view thereof;

FIG. 10 is a rear plan view thereof;

FIG. 11 is a top elevational plan view thereof, the bottom elevational plan view being identical thereto;

FIG. 12 is a front perspective view of a third embodiment of a gun barrel rest showing the new ornamental design thereof;

FIG. 13 is a rear perspective view thereof;

FIG. 14 is a front plan view thereof;

FIG. 15 is a rear plan view thereof;

FIG. 16 is a top elevational plan view thereof, the bottom elevational plan view being identical thereto;

FIG. 17 is a front perspective view of a fourth embodiment of a gun barrel rest showing the new ornamental design thereof;

FIG. 18 is a rear perspective view thereof;

FIG. 19 is a front plan view thereof;

FIG. 20 is a rear plan view thereof; and,

FIG. 21 is a top elevational plan view thereof, the bottom elevational plan view being identical thereto.

1 Claim, 17 Drawing Sheets

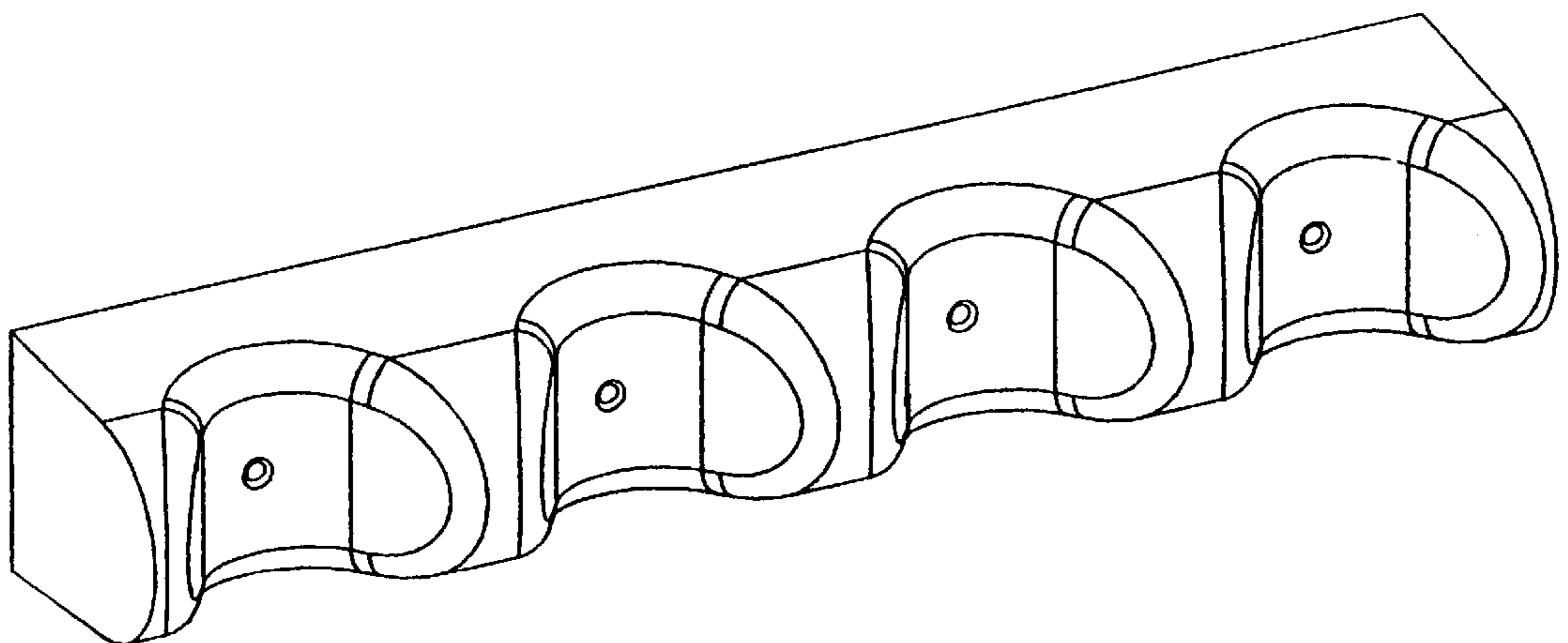

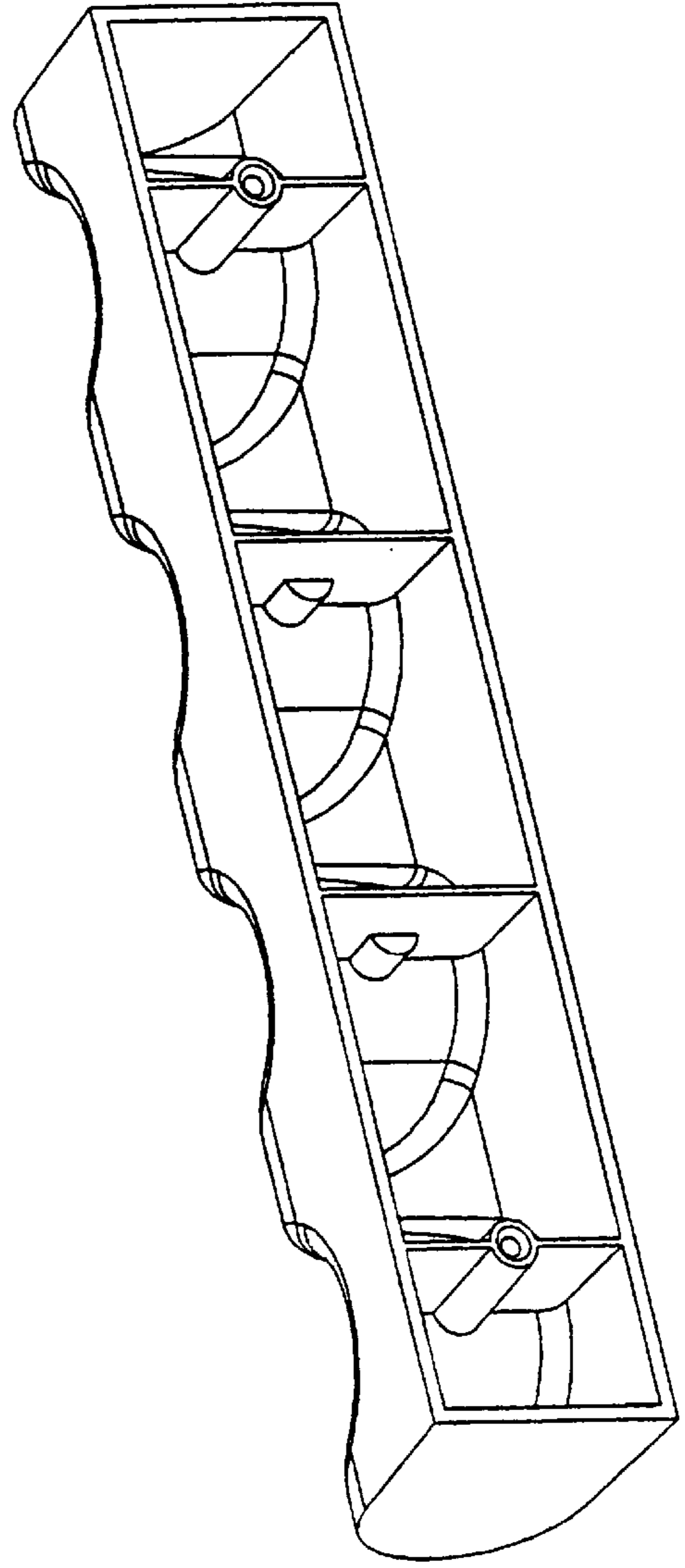
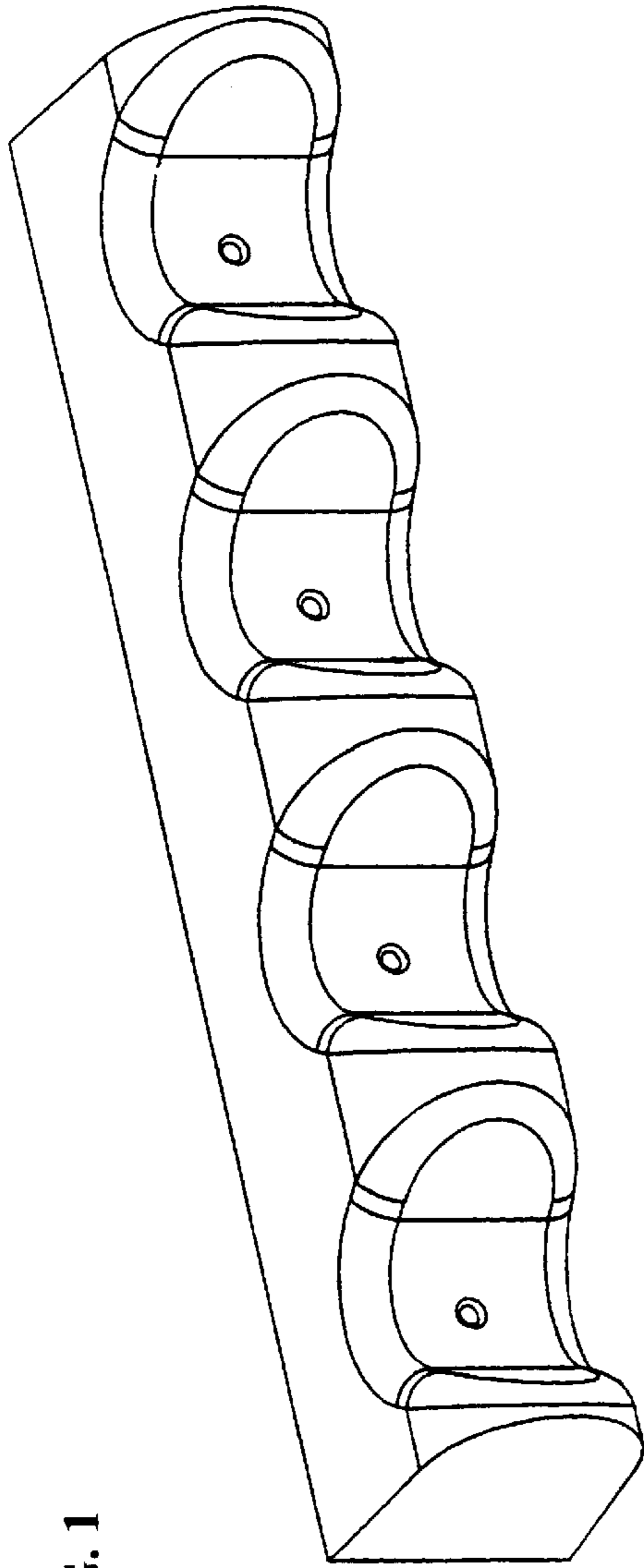

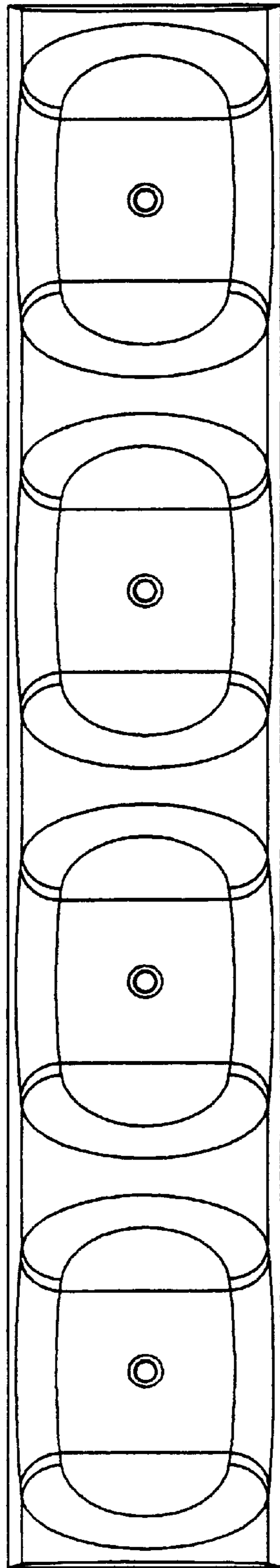

FIG. 3

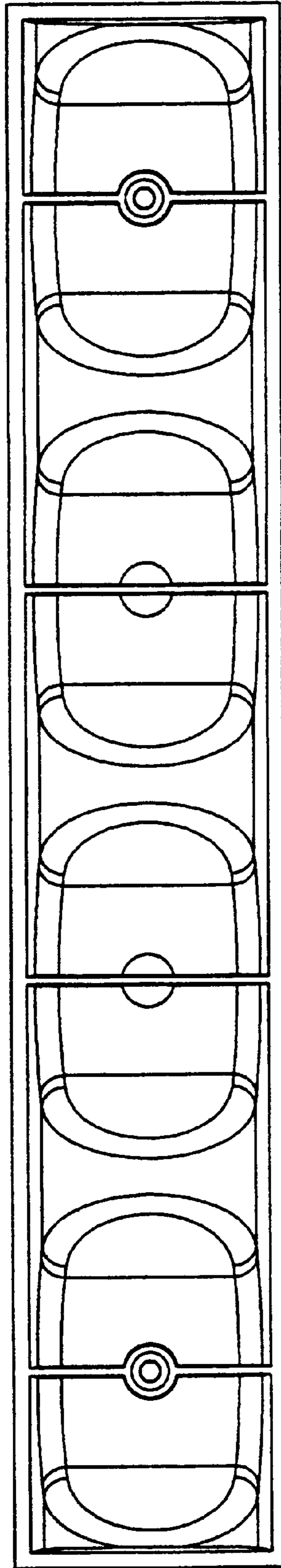

FIG. 4

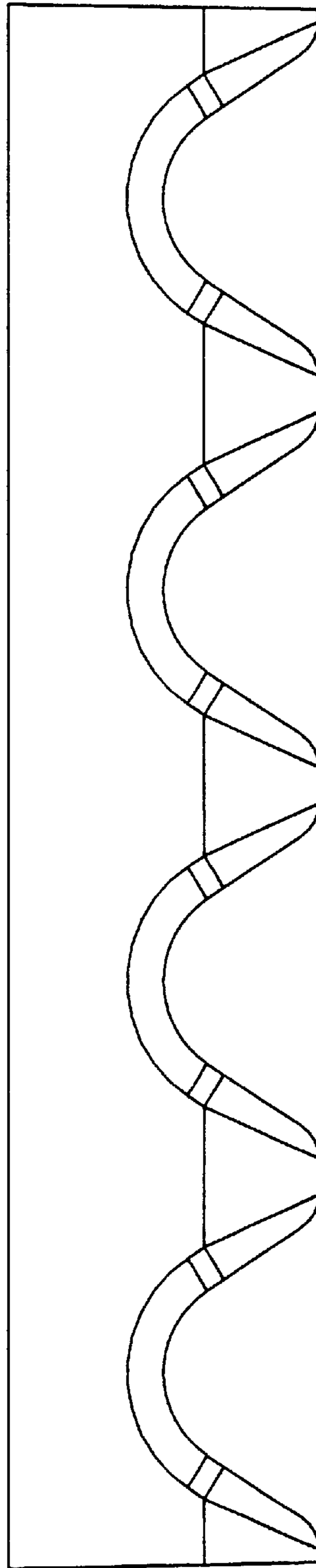

FIG. 5

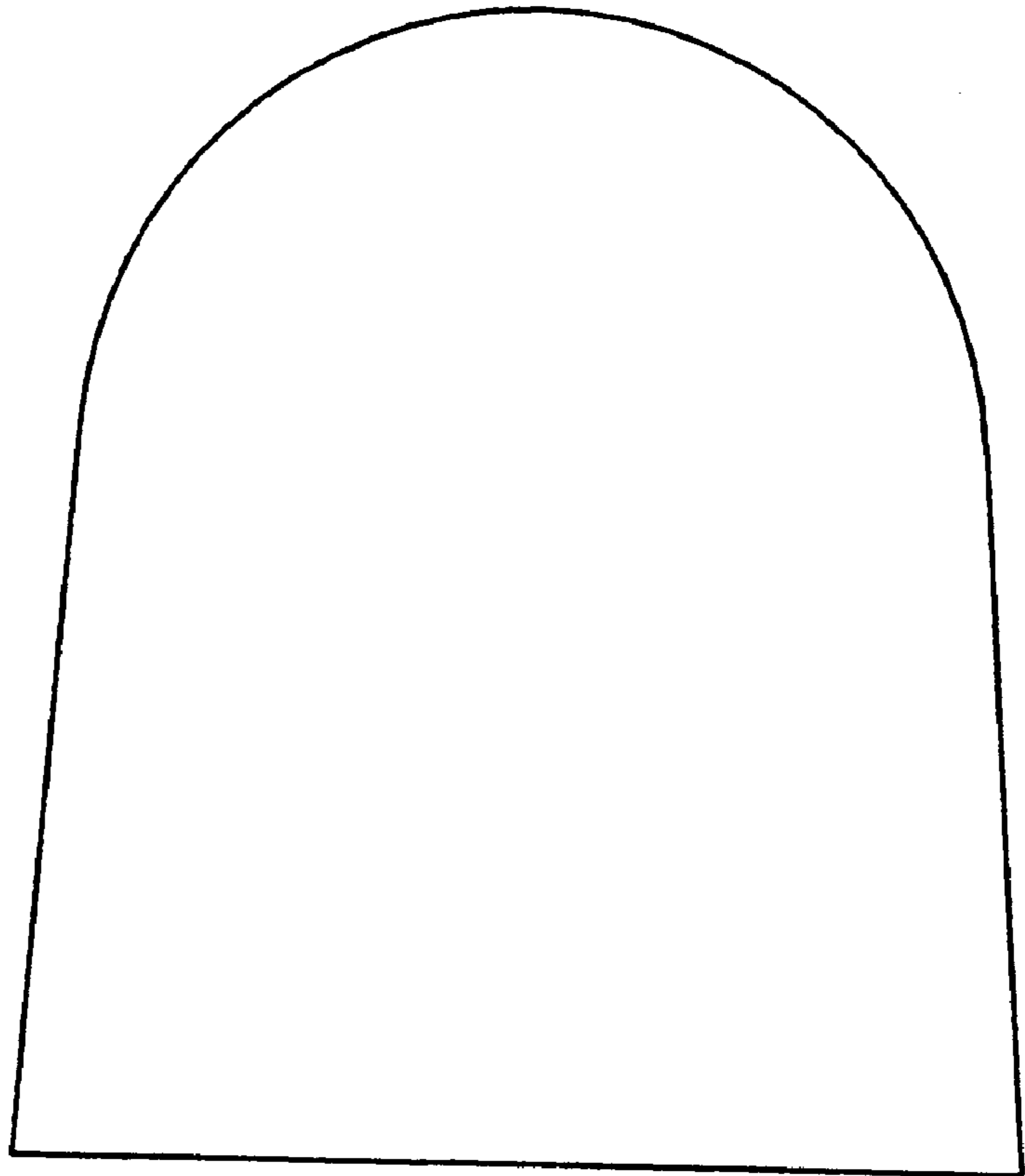
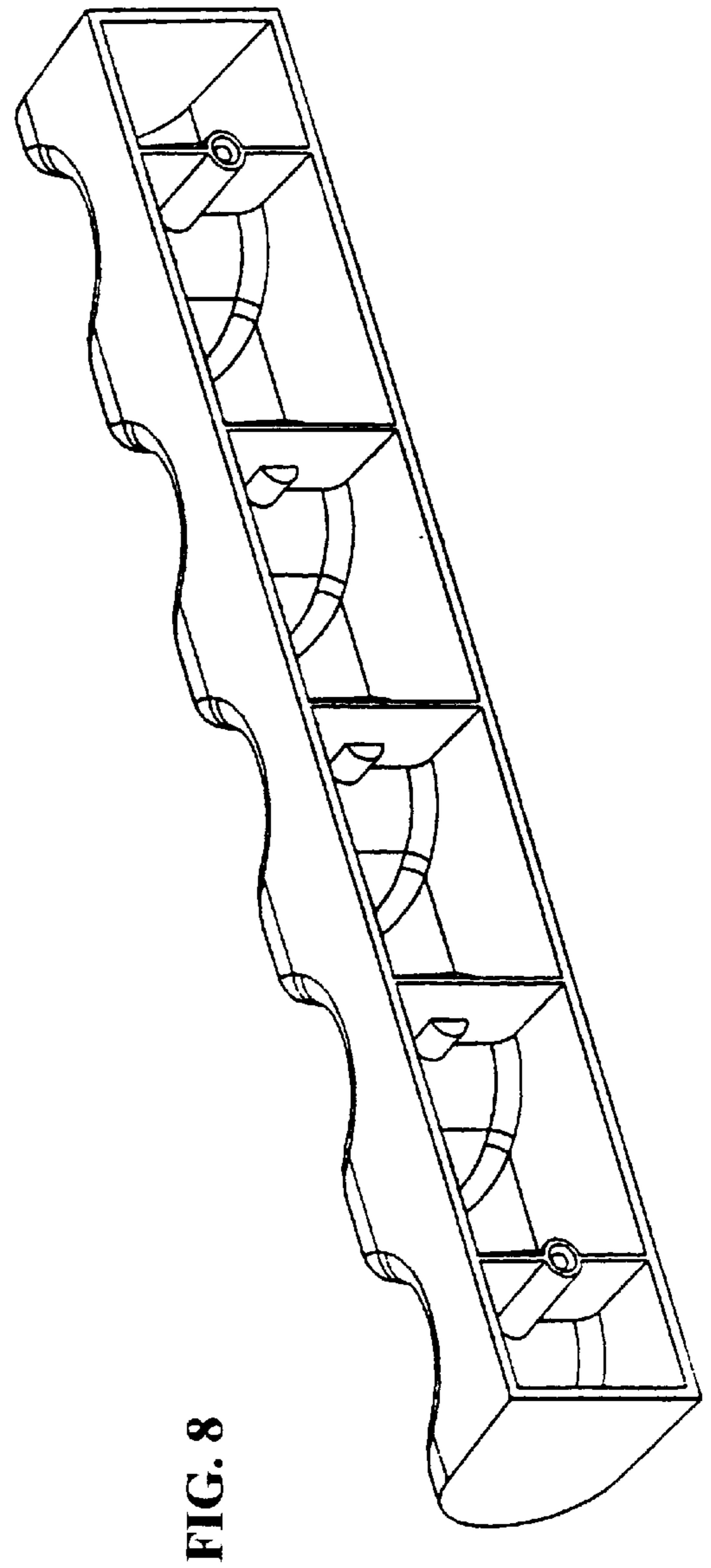
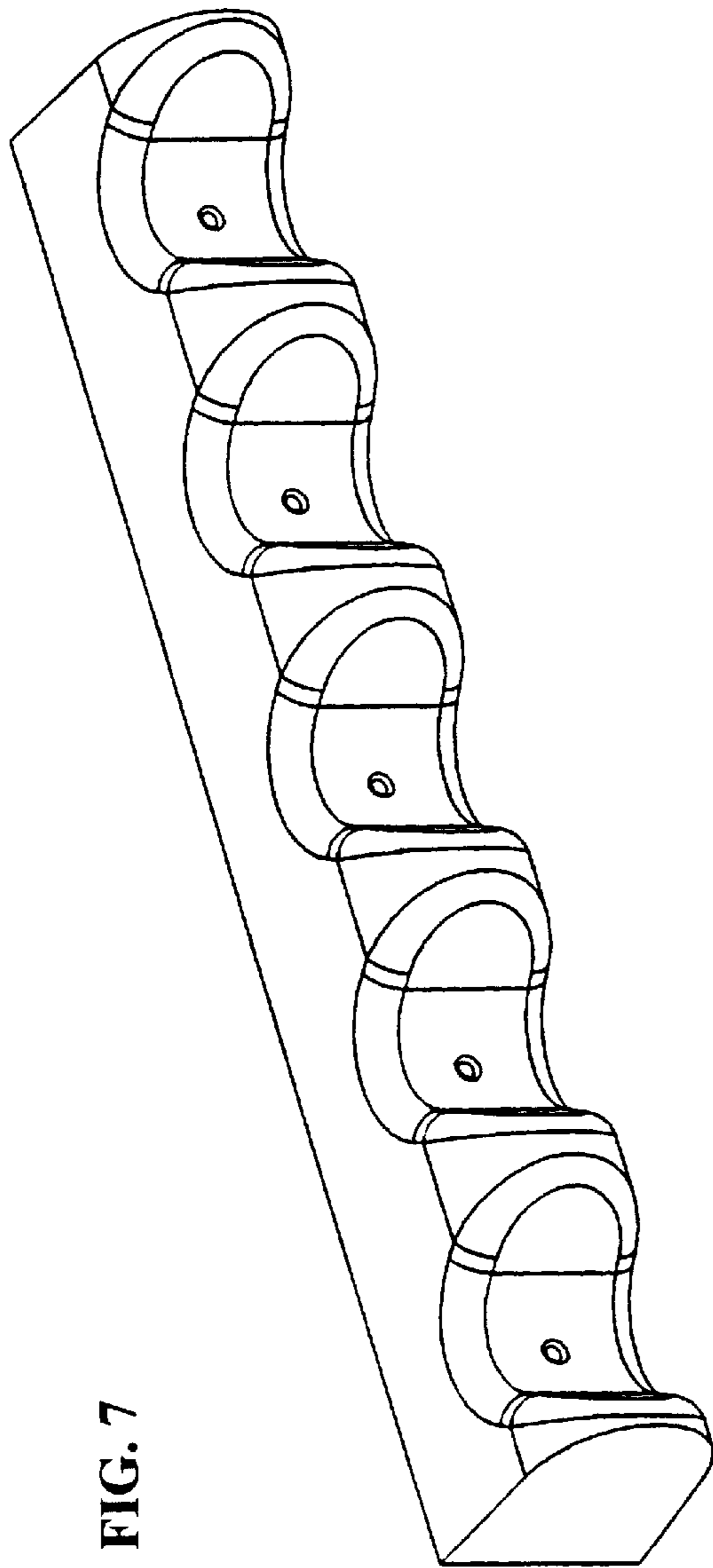

FIG. 6



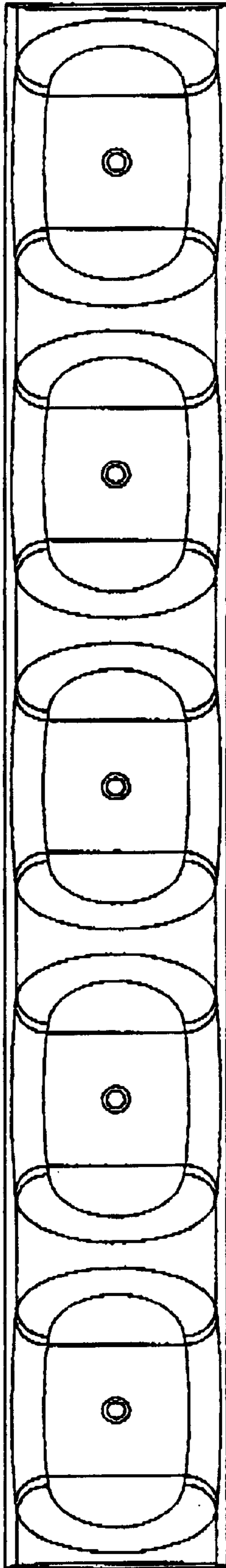

FIG. 9

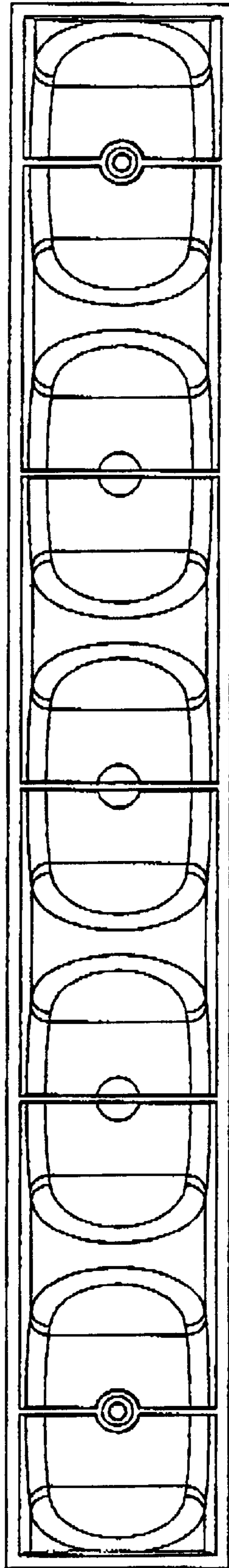
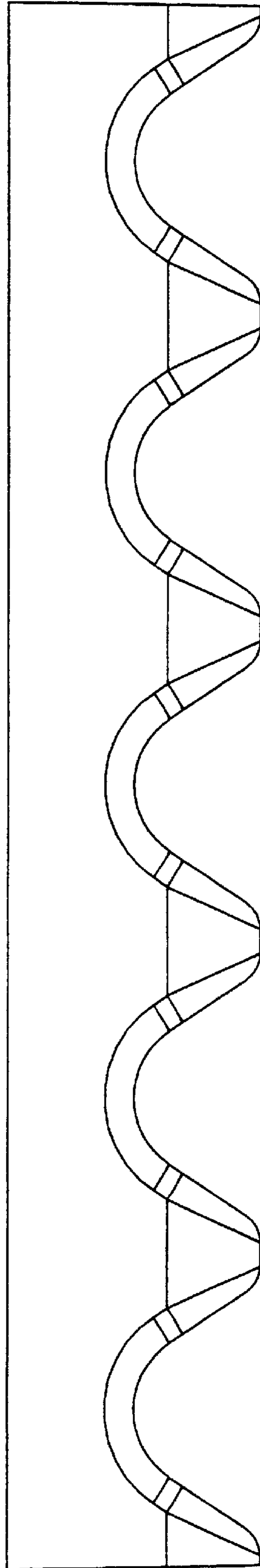

FIG. 10

FIG. 11



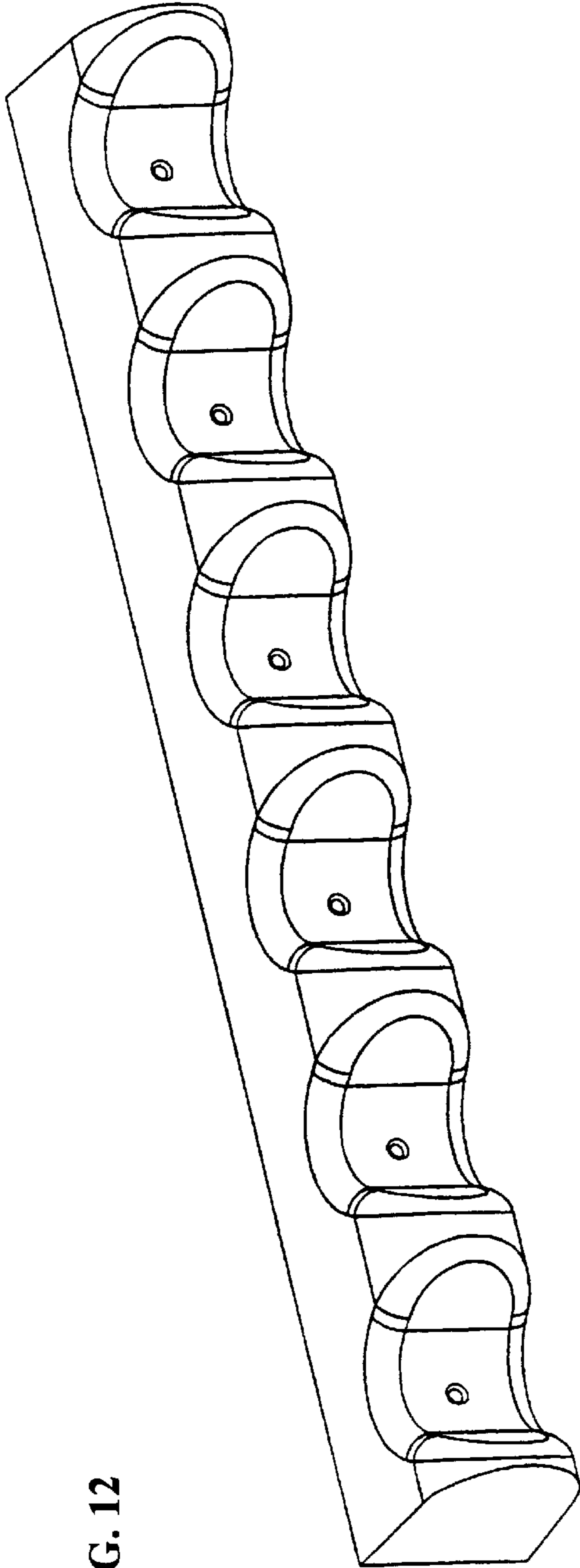

FIG. 12

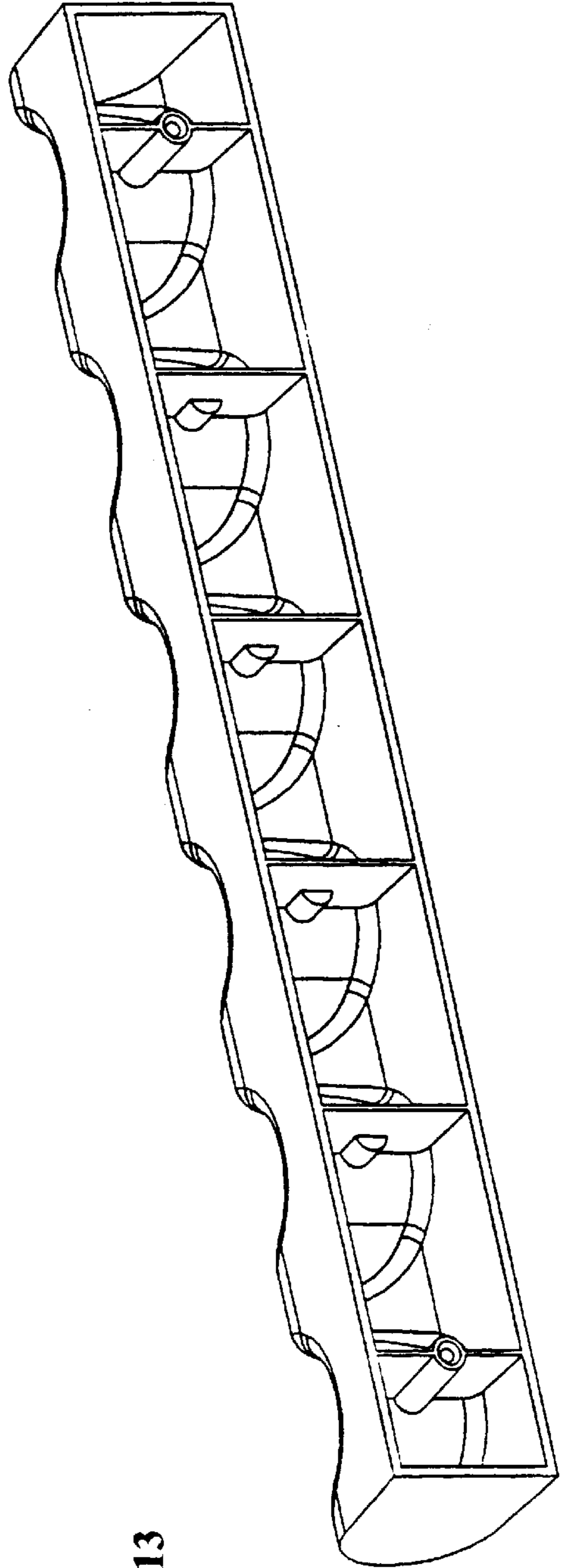
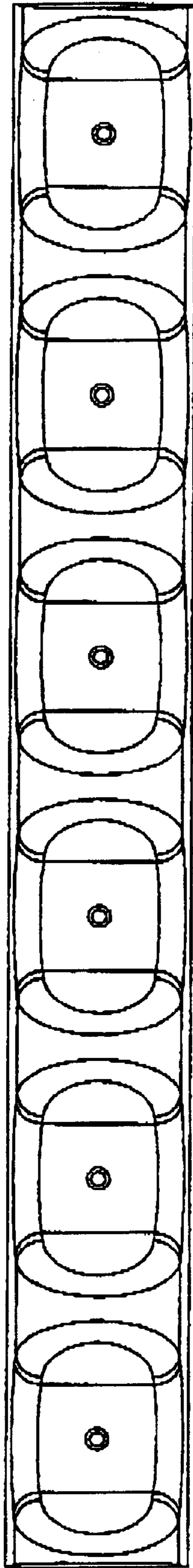

FIG. 13

FIG. 14



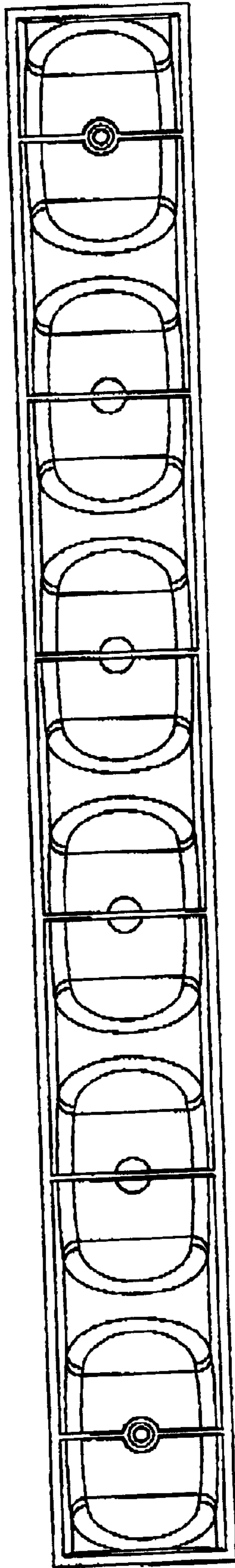

FIG. 15

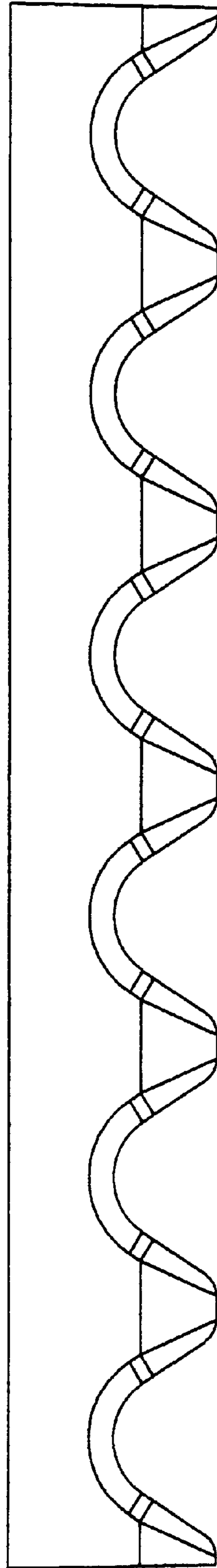

FIG. 16

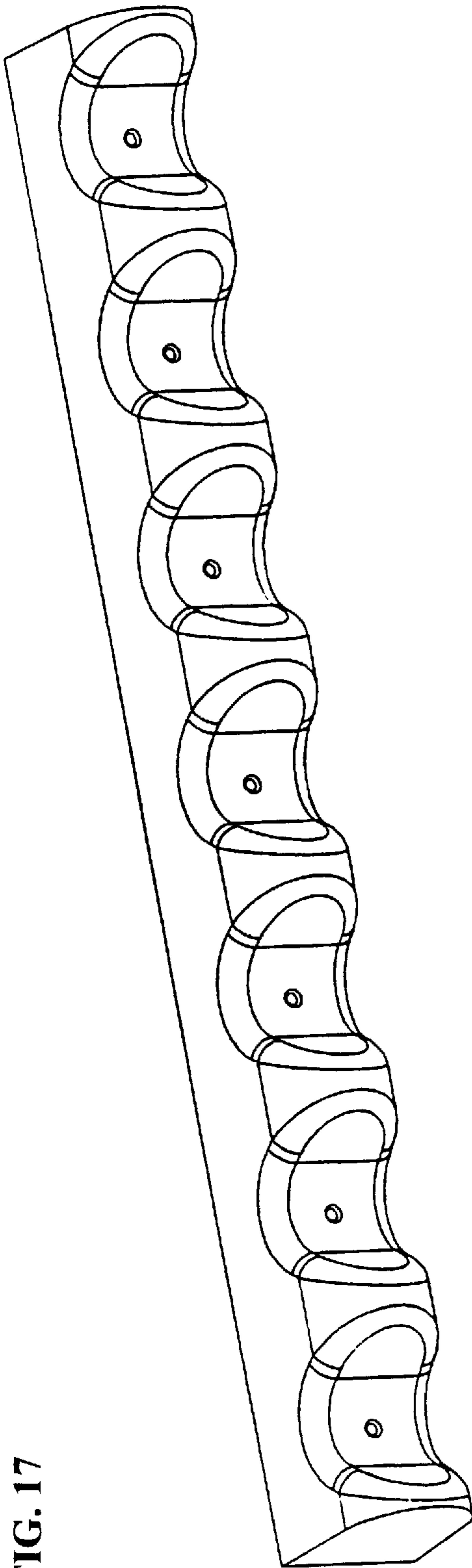

FIG. 17

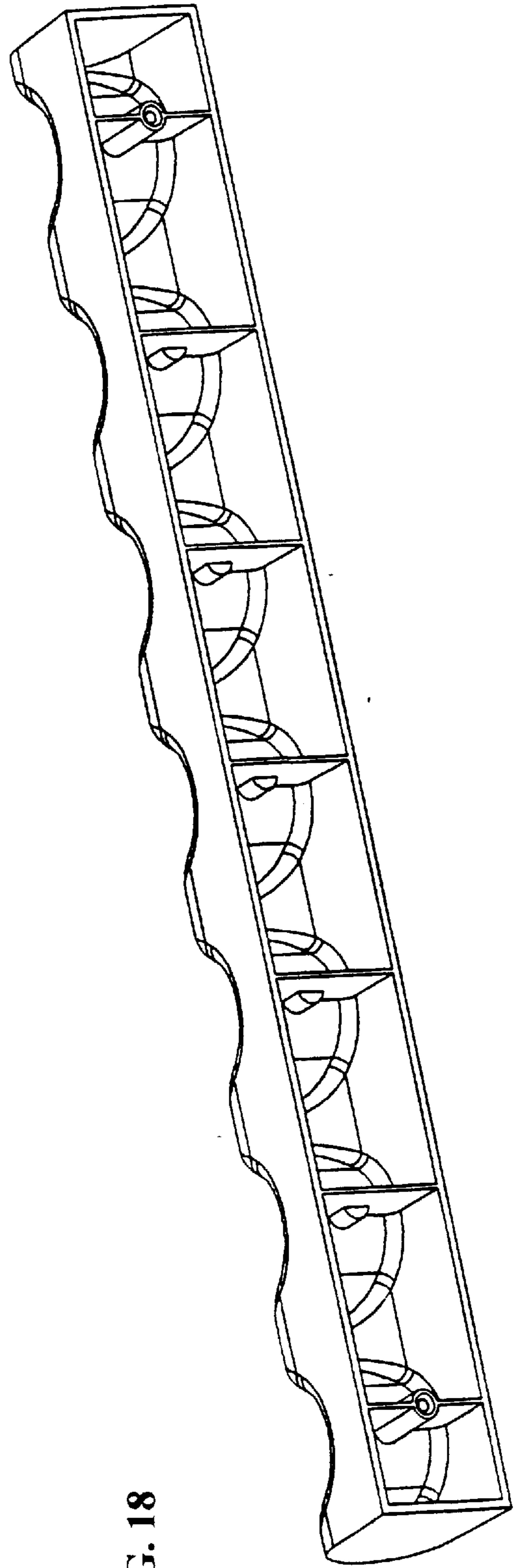

FIG. 18

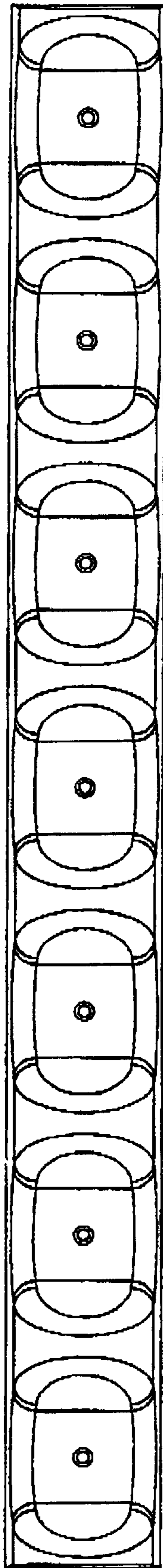

FIG. 19

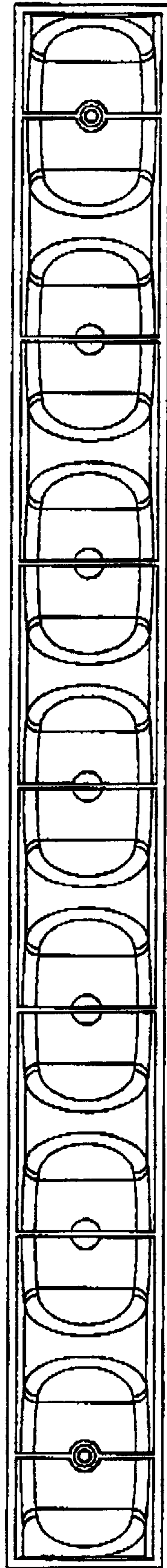

FIG. 20

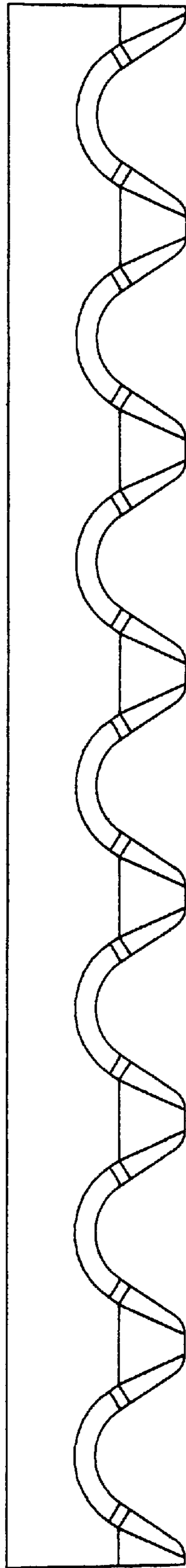

FIG. 21