



US00D457309S

(12) **United States Design Patent**  
**Tanaka**

(10) **Patent No.:** **US D457,309 S**

(45) **Date of Patent:** **\*\* May 21, 2002**

(54) **HOLDER FOR PORTABLE TELEPHONE**

(75) Inventor: **Hiroshi Tanaka**, Osaka (JP)

(73) Assignee: **Sanyo Electric Co., Ltd**, Moriguchi (JP)

(\*\*) Term: **14 Years**

(21) Appl. No.: **29/146,802**

(22) Filed: **Aug. 16, 2001**

(30) **Foreign Application Priority Data**

Mar. 14, 2001 (JP) ..... 2001-006576

(51) **LOC (7) Cl.** ..... **03-01**

(52) **U.S. Cl.** ..... **D3/218**

(58) **Field of Search** ..... D3/218, 219; D14/138, D14/248, 218, 144, 147, 148, 253; 455/550-575; 379/433, 434, 419, 420, 428, 440, 368

(56) **References Cited**

**U.S. PATENT DOCUMENTS**

D369,359 S \* 4/1996 Wright et al. .... D14/253

D406,191 S \* 3/1999 Phillips et al. .... D3/218

D425,907 S \* 5/2000 Frye et al. .... D14/248

D434,898 S \* 12/2000 Jokinen et al. .... D3/218

D451,915 S \* 12/2001 Dalmau ..... D14/253

\* cited by examiner

*Primary Examiner*—Catherine R. Oliver

(74) *Attorney, Agent, or Firm*—Darby & Darby

(57) **CLAIM**

The ornamental design for a holder for portable telephone, as shown and described.

**DESCRIPTION**

FIG. 1 is a top, front, and left side perspective view of my new design for a holder for portable telephone;

FIG. 2 is a front elevation view thereof;

FIG. 3 is a rear elevation view thereof;

FIG. 4 is a top plan view thereof;

FIG. 5 is a bottom plan view thereof;

FIG. 6 is a right side elevation view thereof; and,

FIG. 7 is a left side elevation view thereof.

**1 Claim, 2 Drawing Sheets**

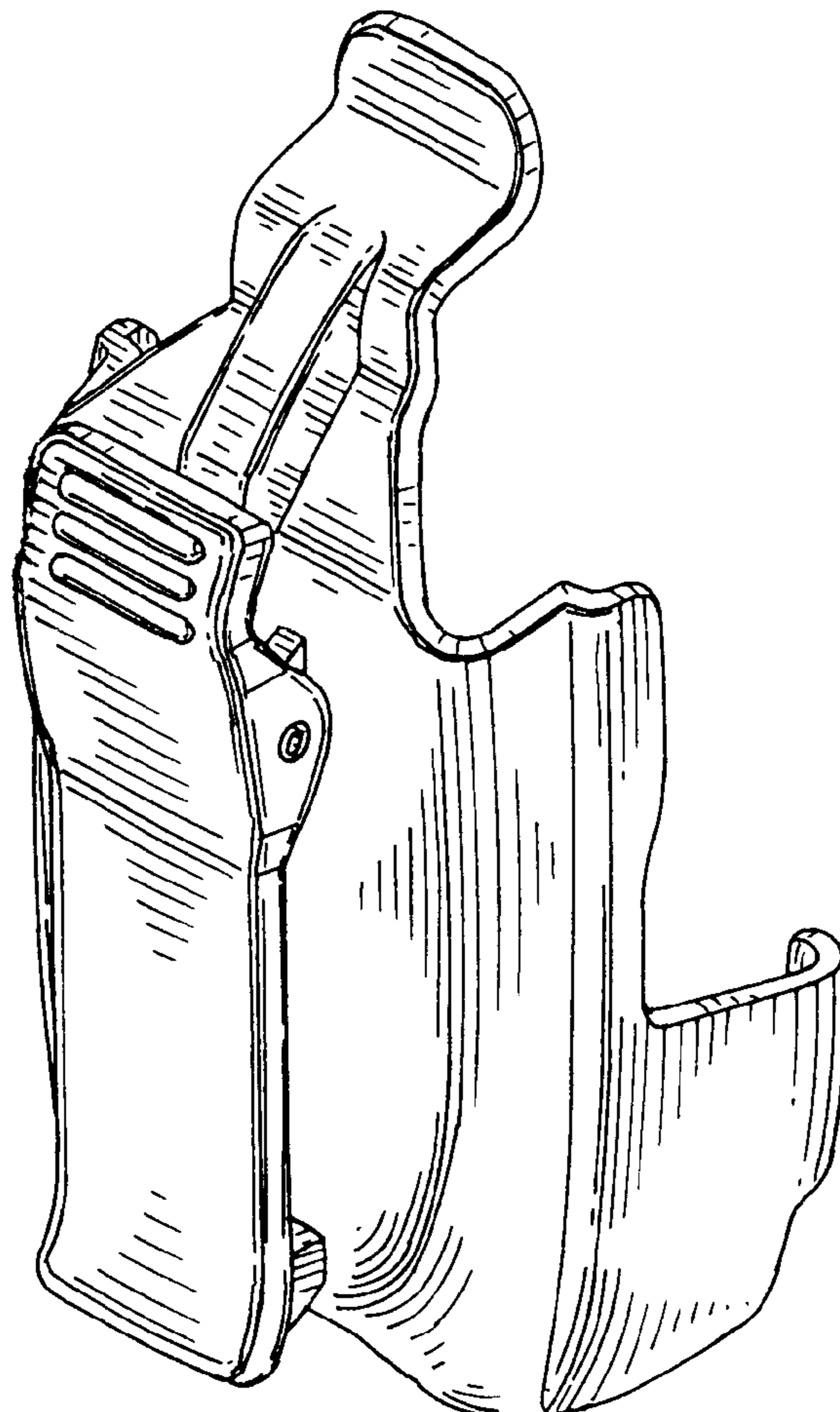

FIG. 3

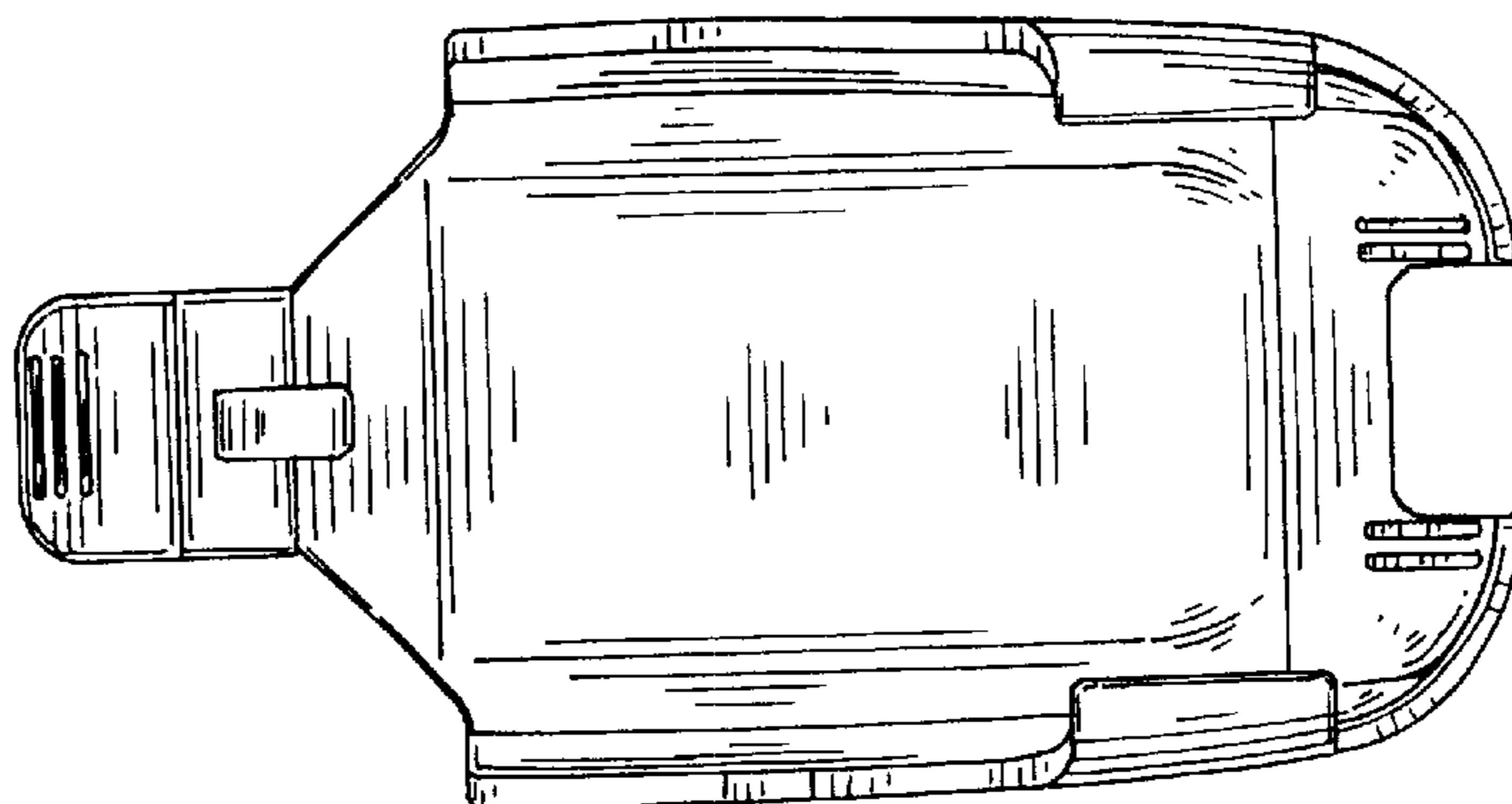

FIG. 2

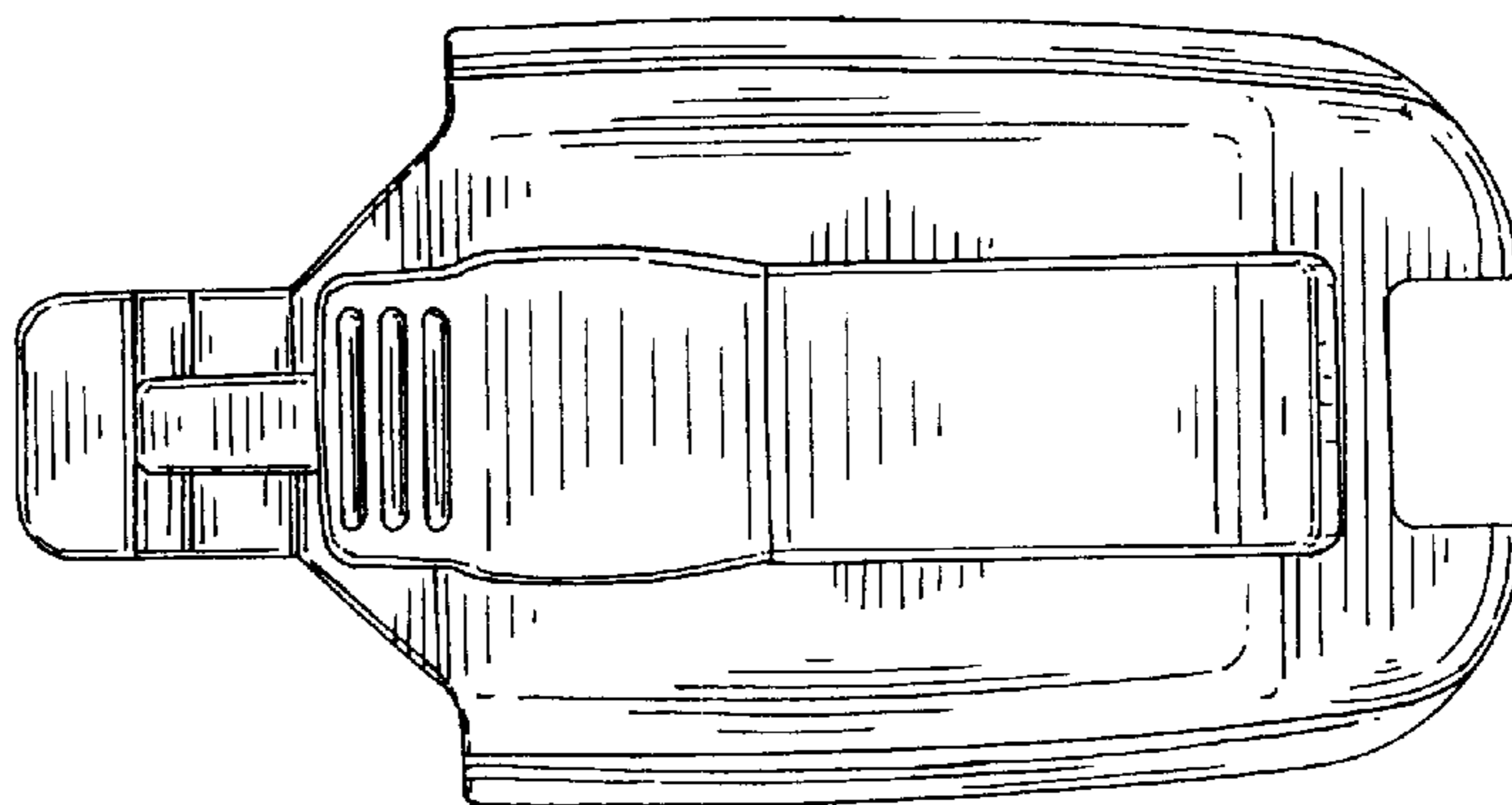

FIG. 1

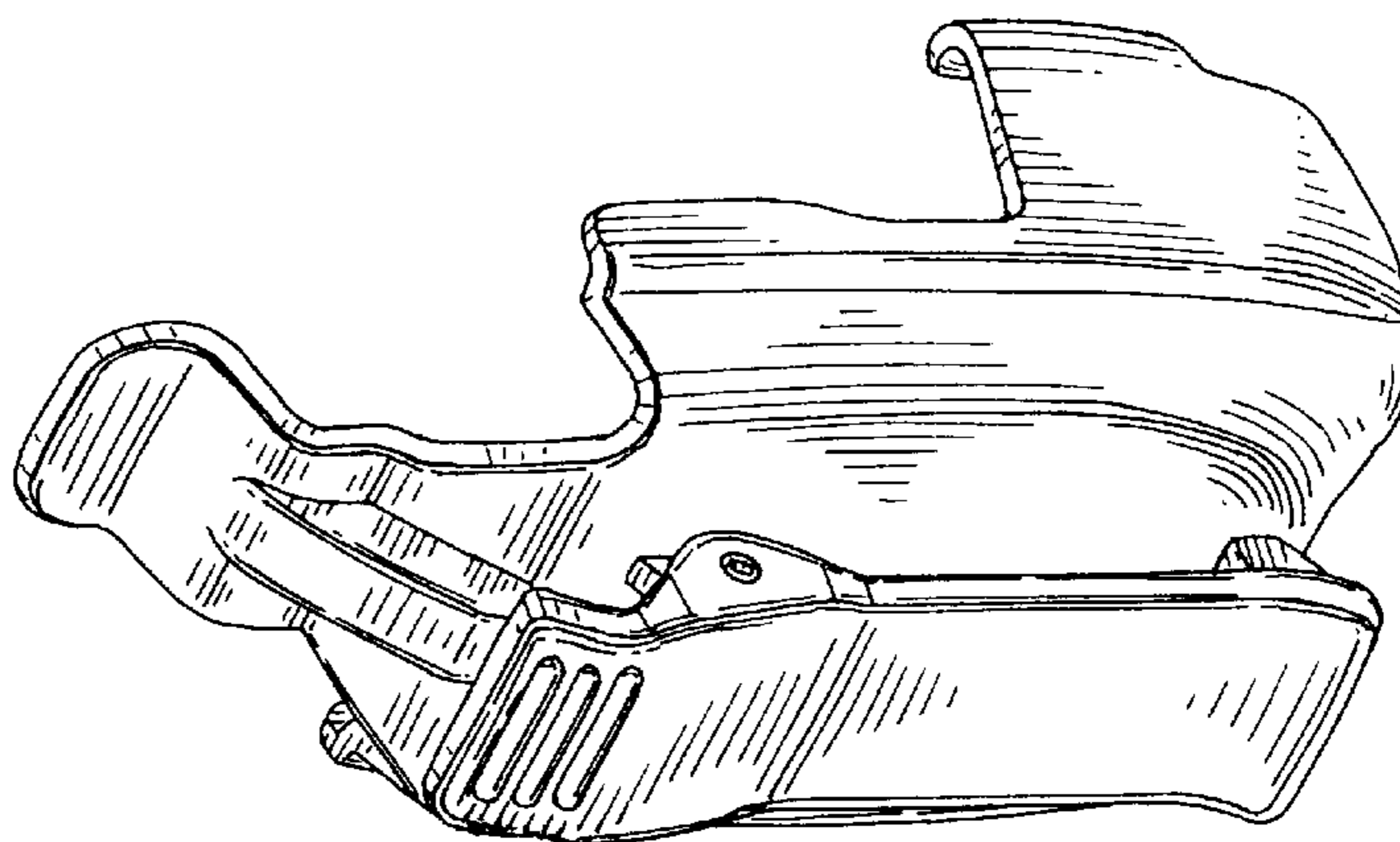

FIG. 4

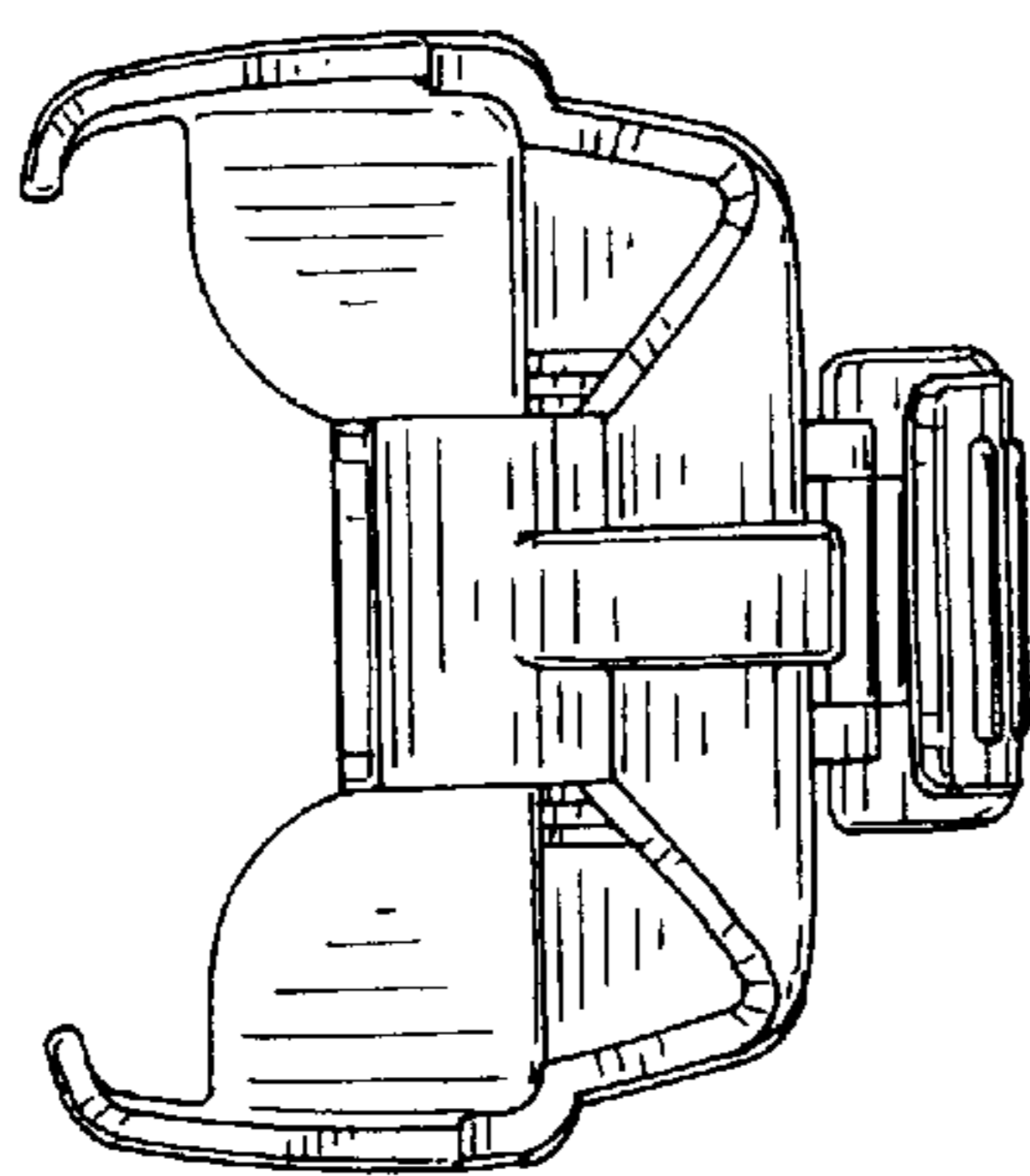

FIG. 5

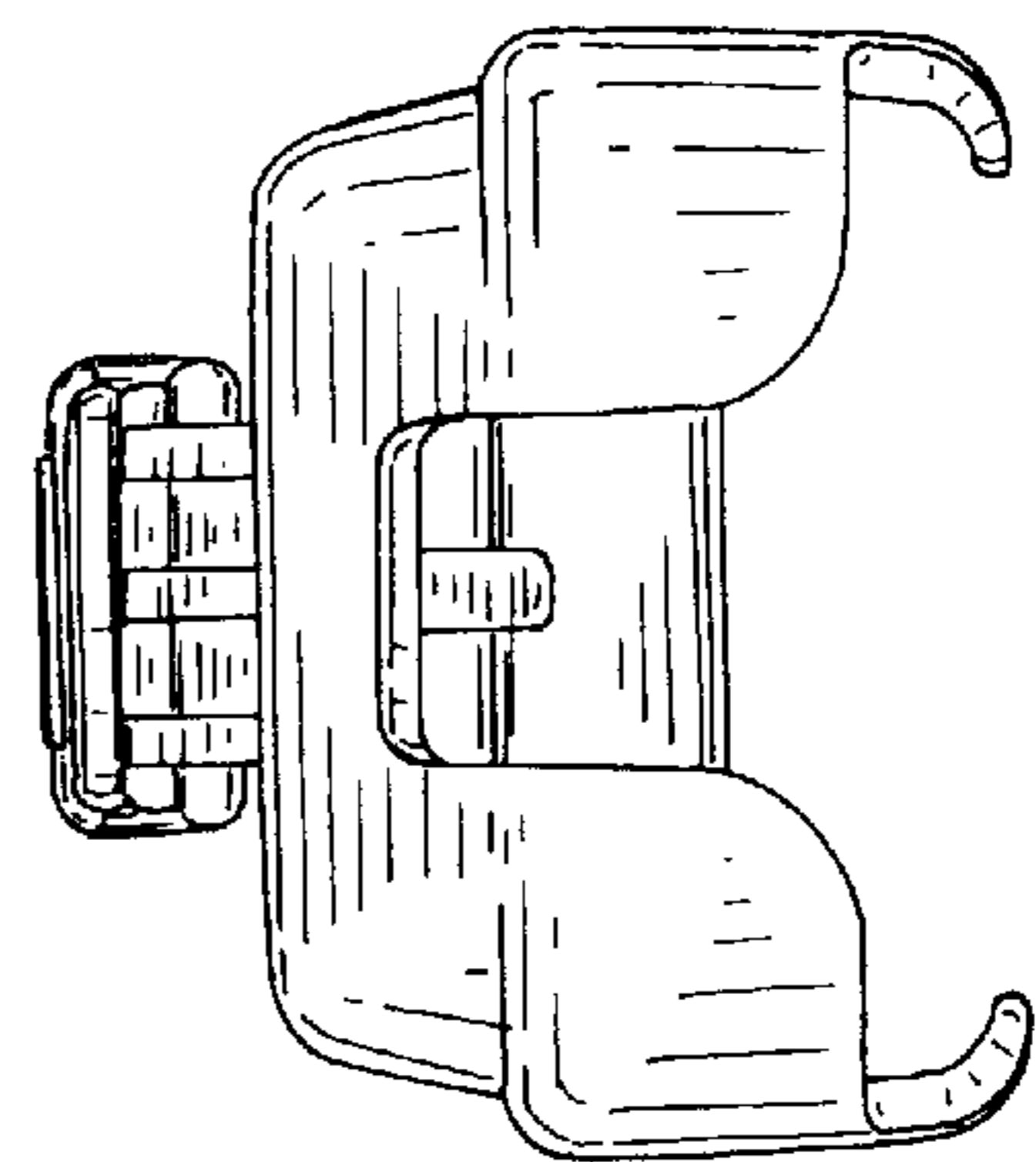

FIG. 7

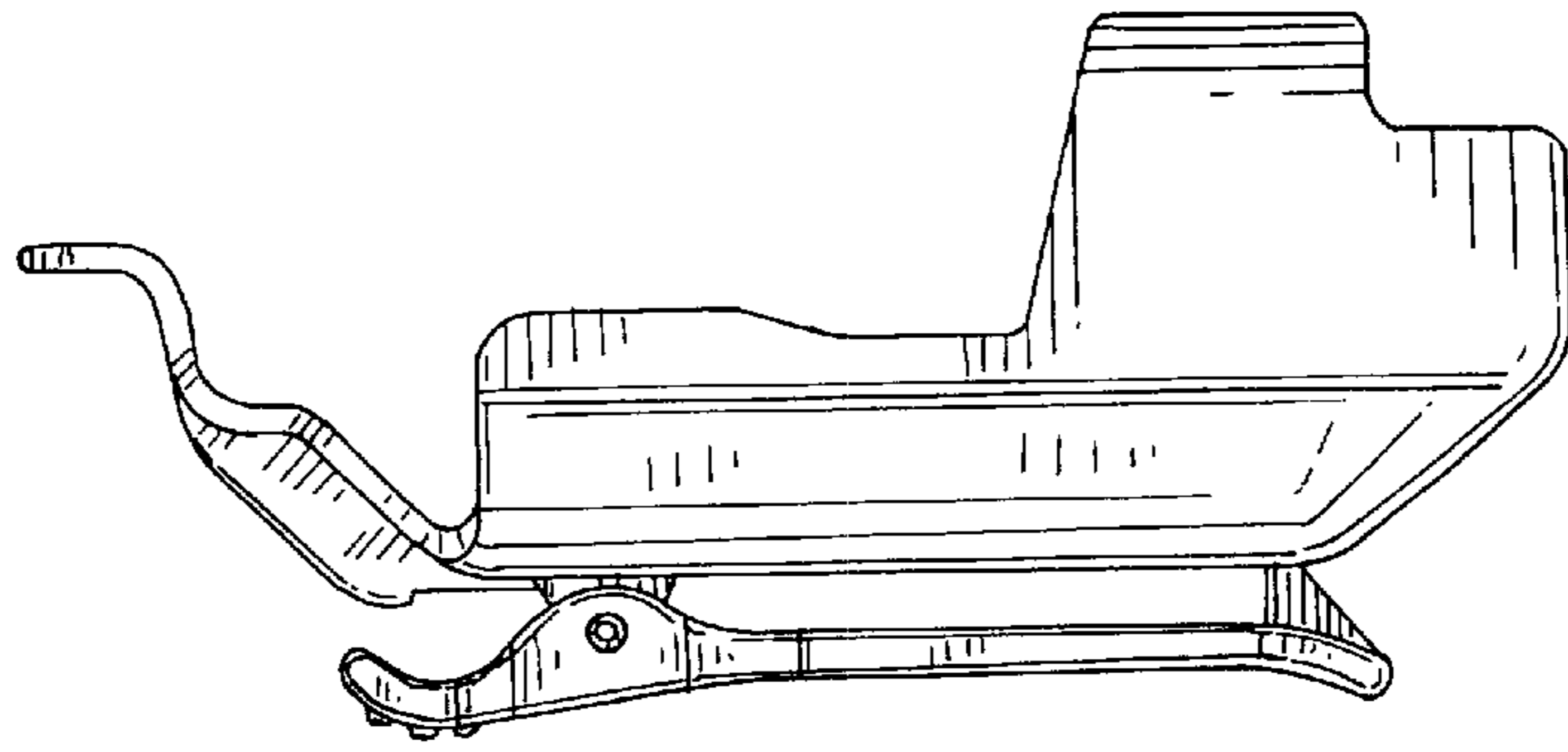

FIG. 6

