



US00D457279S

(12) **United States Design Patent**
Ingram et al.

(10) **Patent No.:** **US D457,279 S**

(45) **Date of Patent:** **** May 14, 2002**

(54) **GARBAGE DISPOSAL PLUNGER**

D375,434 S * 11/1996 Roussel D7/375

(76) Inventors: **Craig T. Ingram; Nicki Ingram**, both
of 16299 Jatos Cir., Lakeville, MN (US)
55044

* cited by examiner

Primary Examiner—Jennifer Rivard
(74) *Attorney, Agent, or Firm*—Gene Scott-Patent Law &
Venture Group

(**) Term: **14 Years**

(21) Appl. No.: **29/145,351**

(57) **CLAIM**

(22) Filed: **Jul. 20, 2001**

The ornamental design for a garbage disposal plunger, as
shown and described.

(51) **LOC (7) Cl.** **08-99**

DESCRIPTION

(52) **U.S. Cl.** **D32/35**

(58) **Field of Search** D32/14, 35, 49;
15/406; 4/255.01, 255.05, 255.09, 255.11,
255.12, 255.07

FIG. 1 is a front elevation view of a garbage disposal
plunger, showing my new design;
FIG. 2 is a rear elevation view thereof;
FIG. 3 is a left side elevation view thereof;
FIG. 4 is a right side elevation view thereof;
FIG. 5 is a top plan view thereof;
FIG. 6 is a bottom plan view thereof; and,
FIG. 7 is a perspective view thereof.

(56) **References Cited**

U.S. PATENT DOCUMENTS

- 2,939,154 A * 6/1960 Gasser 4/255.01
- 2,999,264 A * 9/1961 Stearns 15/406
- 5,488,749 A * 2/1996 Pearce et al. 15/105

1 Claim, 6 Drawing Sheets

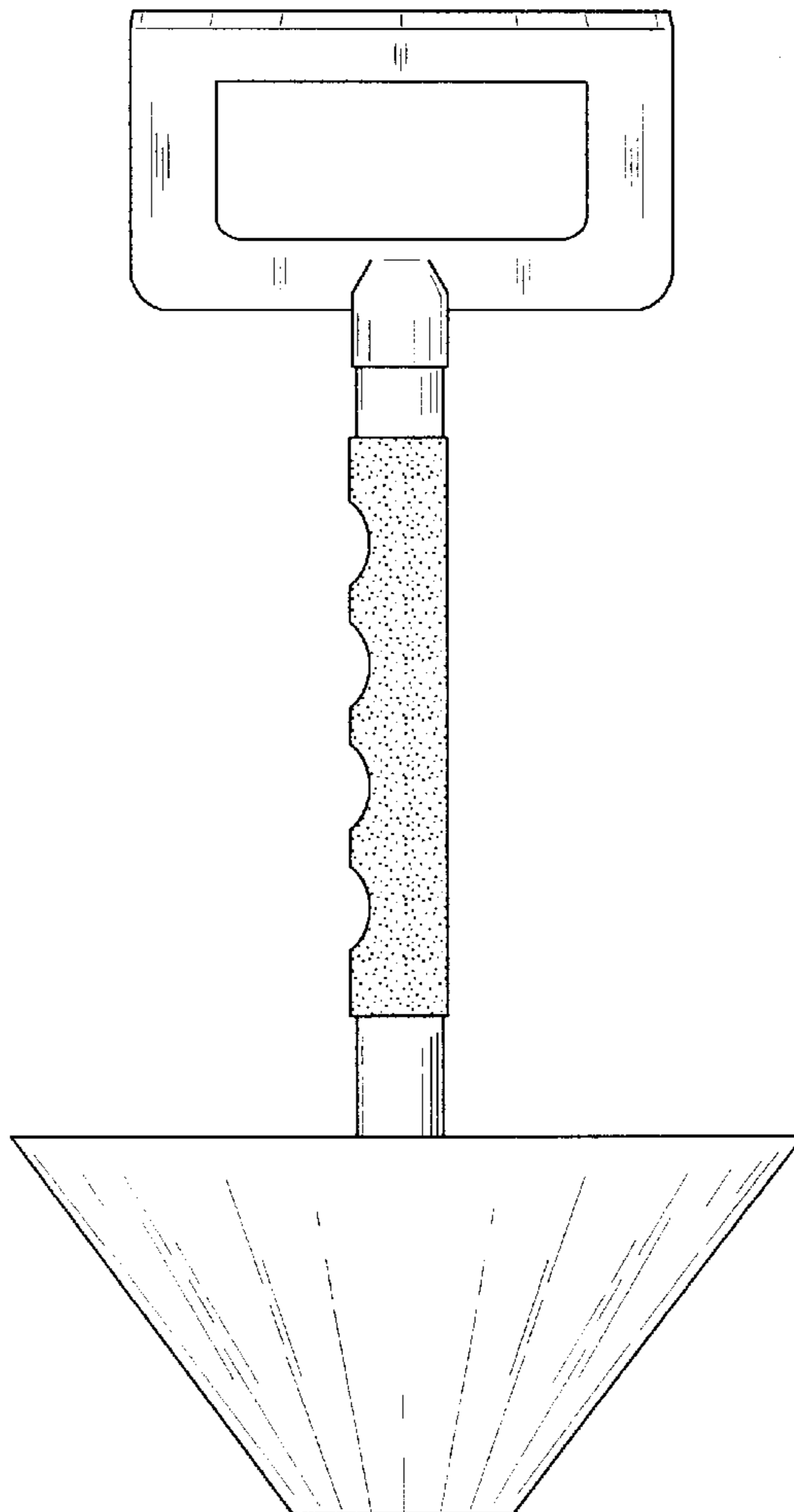

Fig. 1

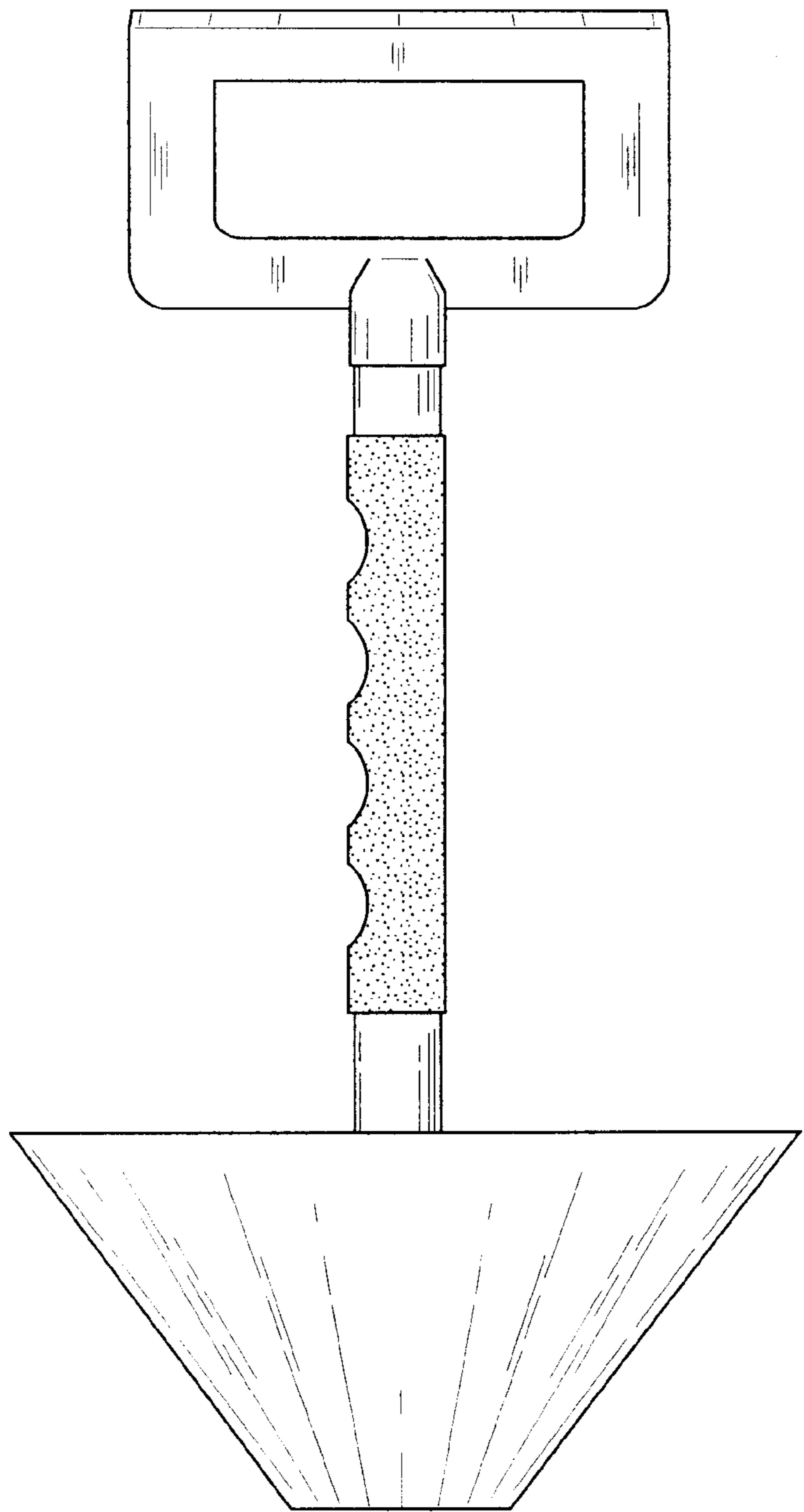

Fig. 2

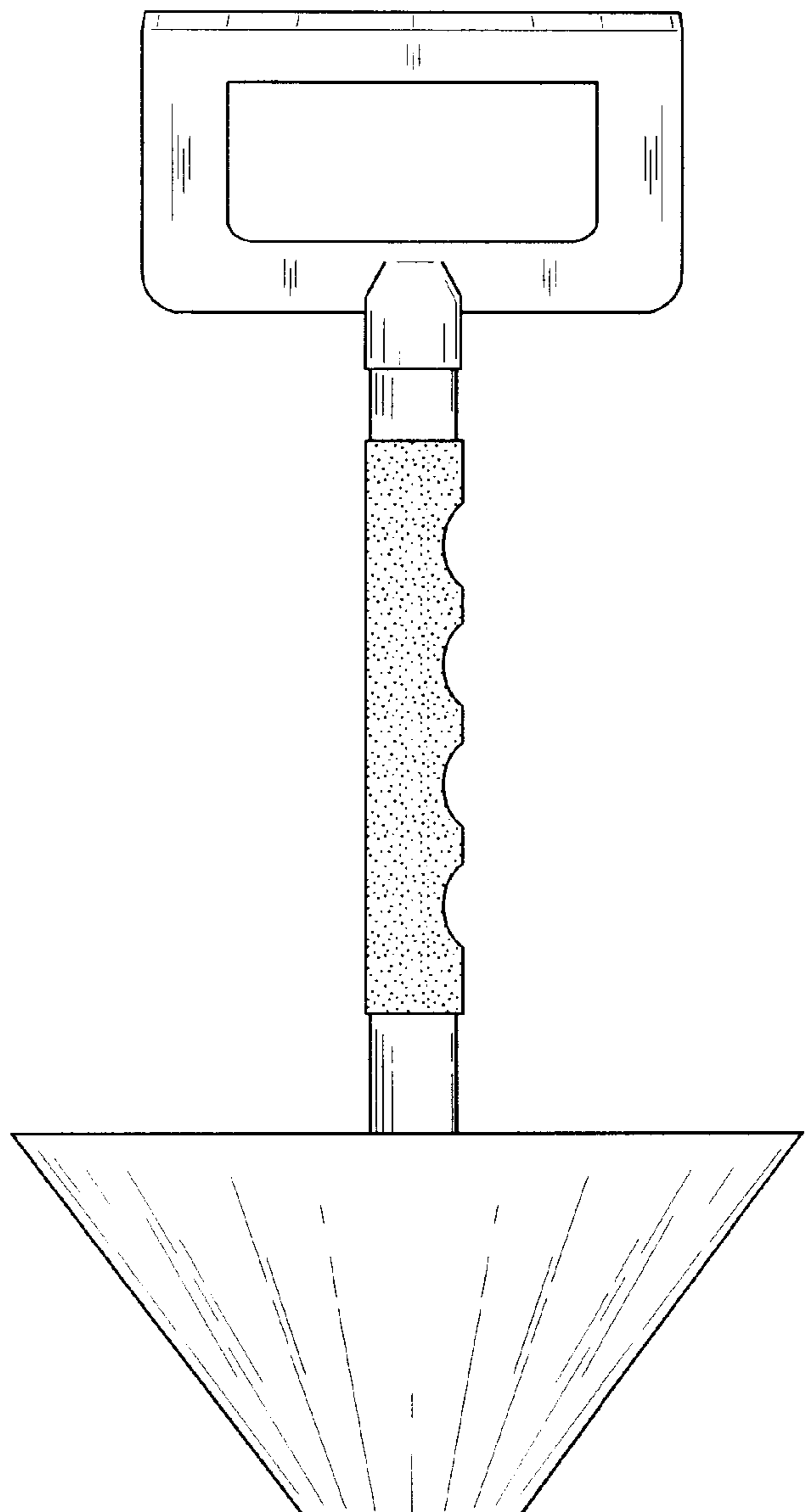

Fig. 3

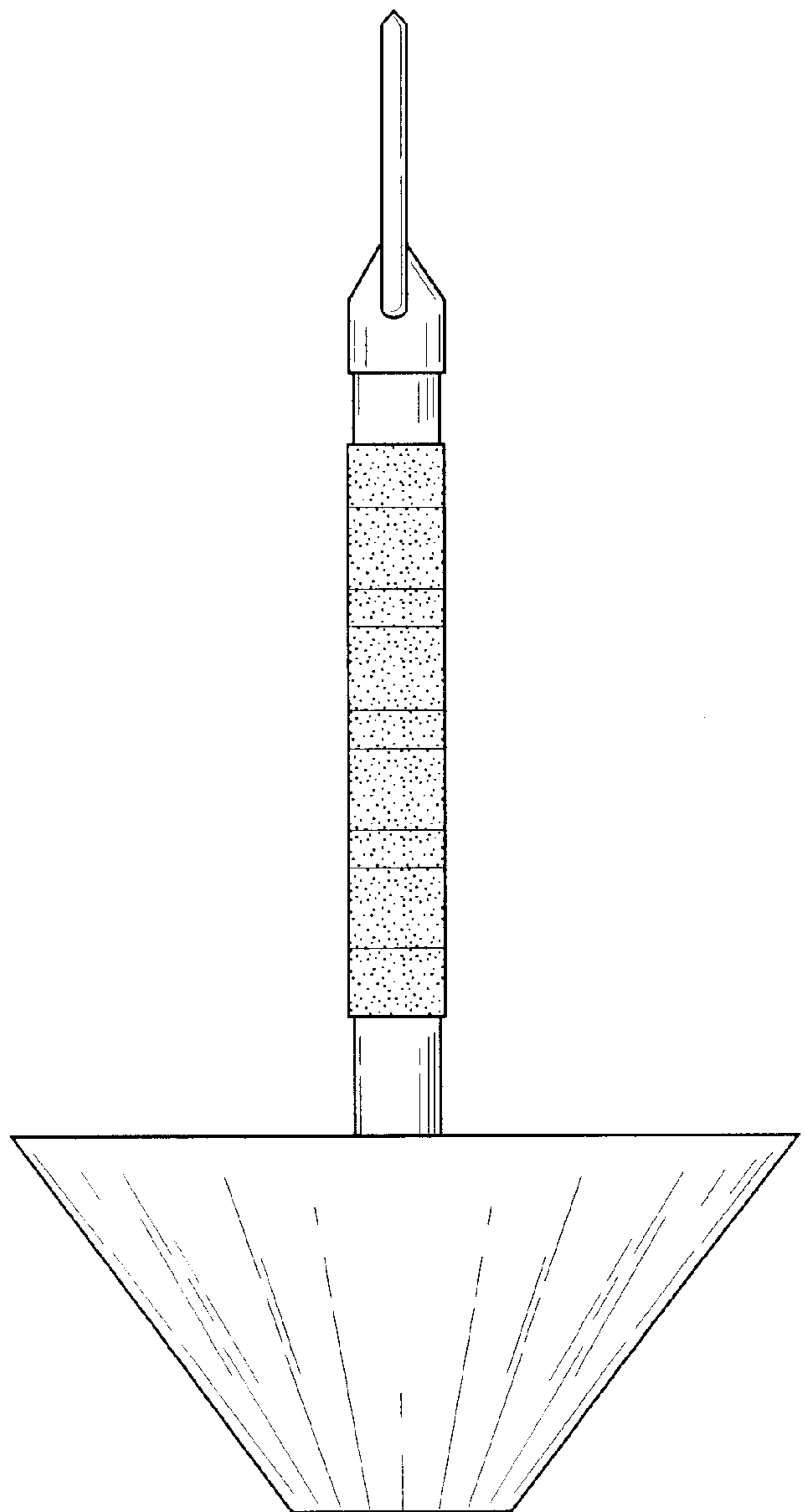

Fig. 4

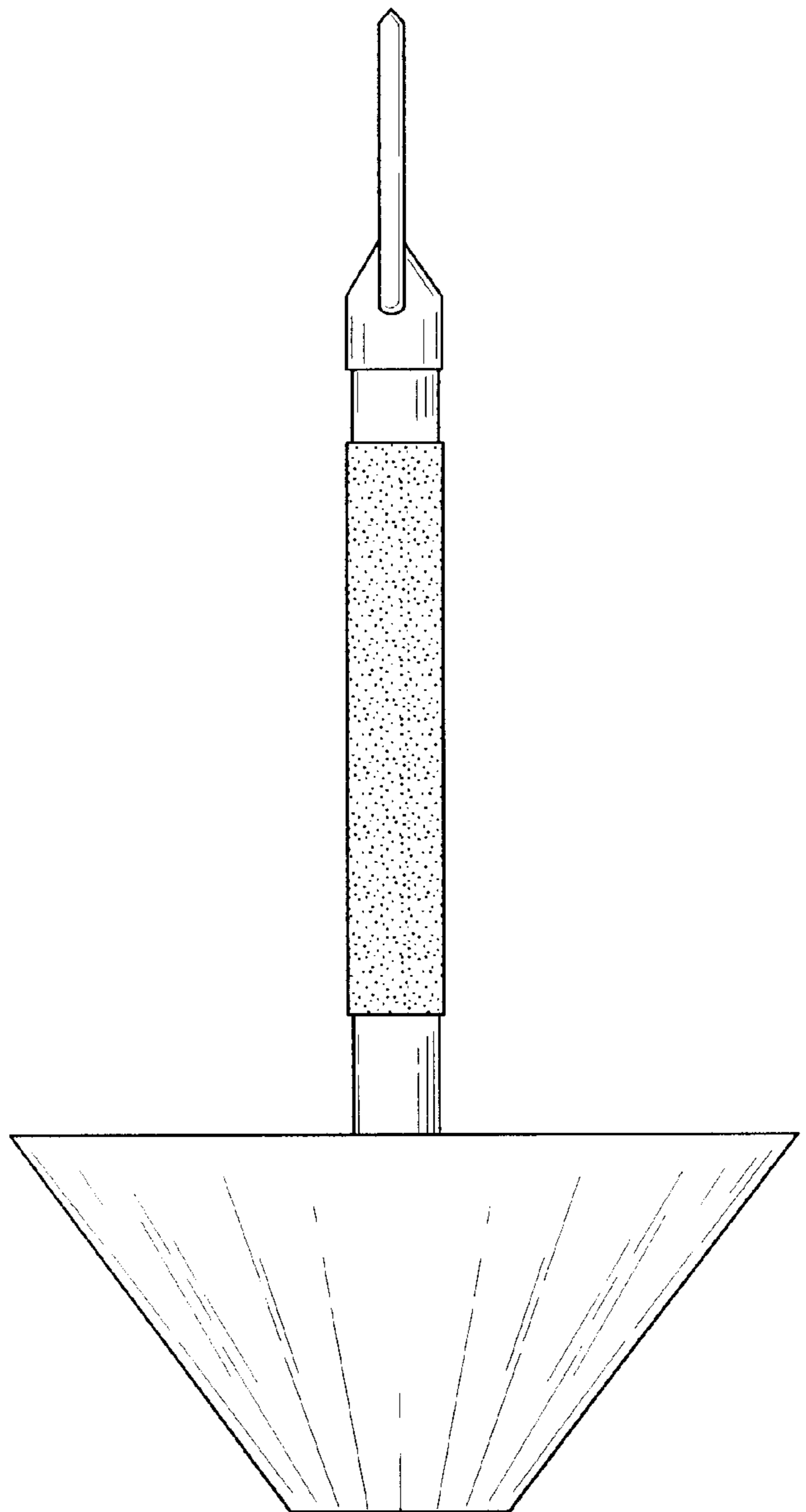

Fig. 5

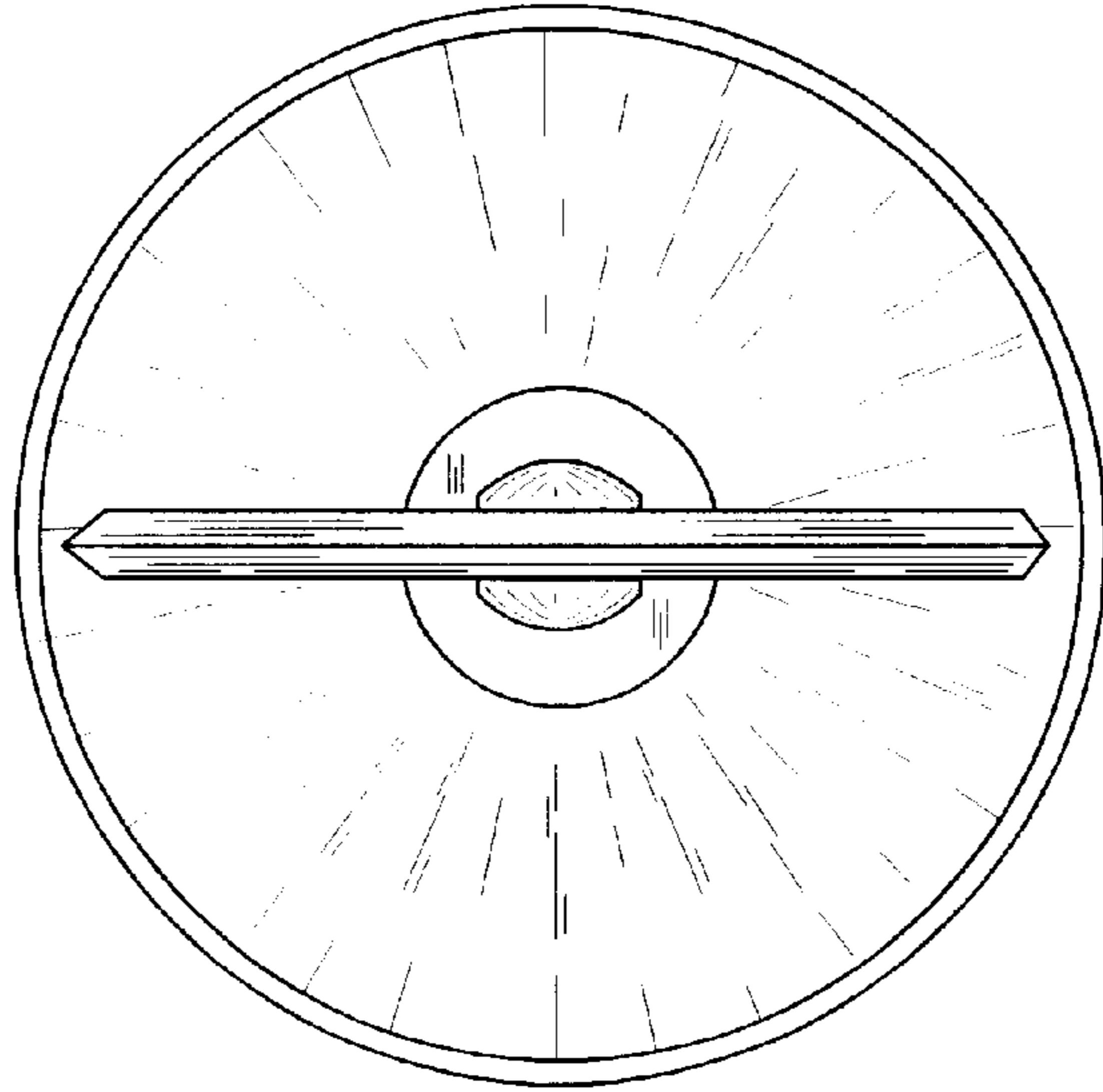

Fig. 6

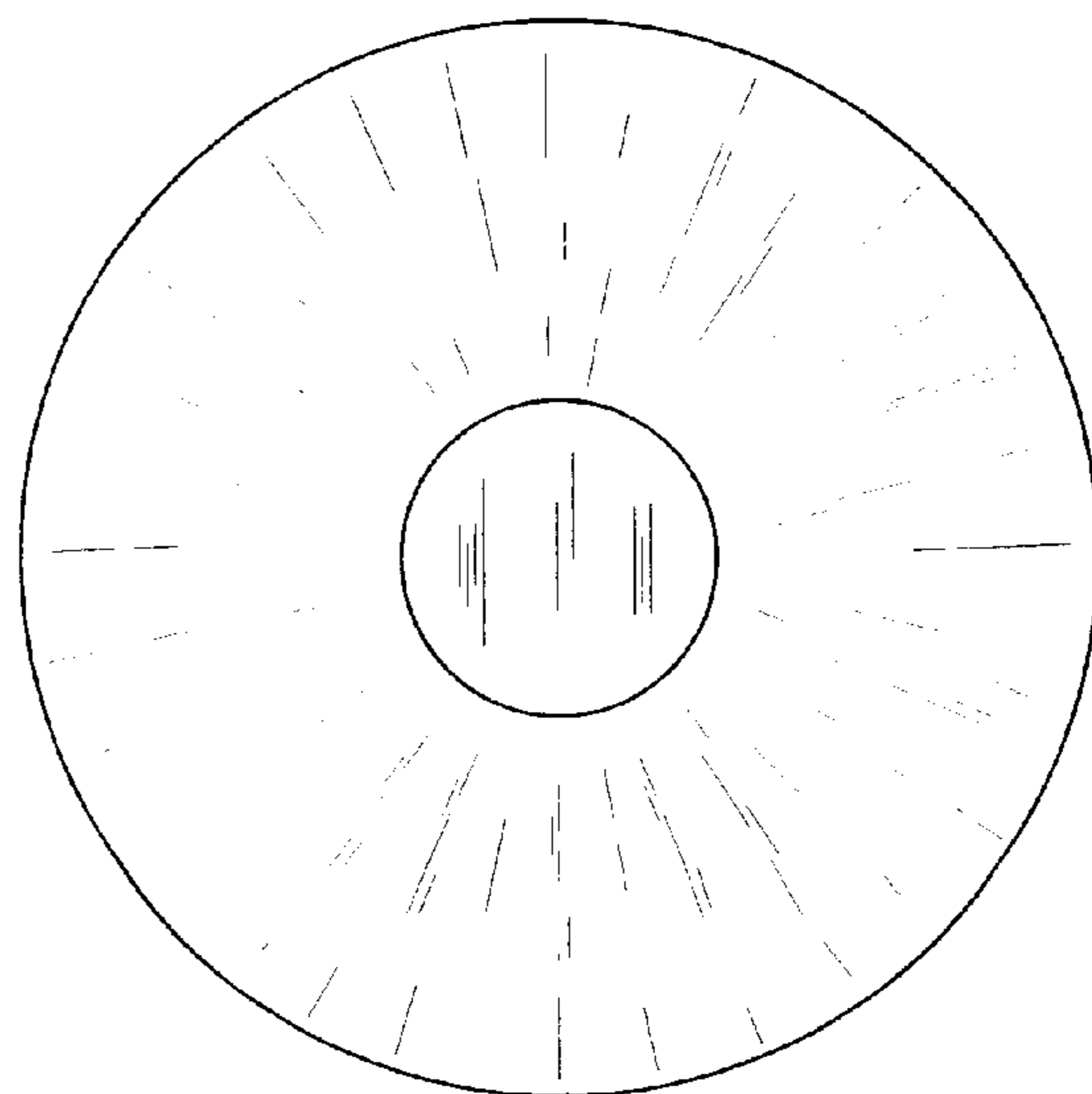

Fig. 7

