



US00D457173S

(12) **United States Design Patent**  
**Harden et al.**

(10) **Patent No.:** **US D457,173 S**  
(45) **Date of Patent:** **\*\* May 14, 2002**

(54) **PLANTER ROW UNIT SHANK MOUNTING BRACKET**

*Primary Examiner*—Mitchell Siegel

(75) Inventors: **Tad Brian Harden**, Parkview, IA (US);  
**Roger Eugene Mixer**, East Moline, IL (US)

(57) **CLAIM**

The ornamental design for a planter row unit shank mounting bracket, as shown and described.

(73) Assignee: **Deere & Company**, Moline, IL (US)

(\*\*) Term: **14 Years**

**DESCRIPTION**

(21) Appl. No.: **29/128,176**

FIG. 1 is a perspective view of a planter row unit shank mounting bracket showing our new design, the broken lines showing a planter unit being for illustrative purposes only, and forms no part of the claimed design.

(22) Filed: **Aug. 7, 2000**

FIG. 2 is a rear/right perspective view of the planter row unit shank mounting bracket design of FIG. 1.

(51) **LOC (7) Cl.** ..... **15-03**

(52) **U.S. Cl.** ..... **D15/28**

(58) **Field of Search** ..... D15/28, 33; 111/85,  
111/87, 88

FIG. 3 is top view of the planter row unit shank mounting bracket design of FIG. 1.

(56) **References Cited**

**U.S. PATENT DOCUMENTS**

4,141,302	A	*	2/1979	Morrison, Jr. et al.	.....	111/87
4,404,918	A	*	9/1983	Whalen et al.	.....	111/85
4,425,857	A	*	1/1984	Lienemann et al.	.....	111/85
4,430,952	A	*	2/1984	Murray	.....	111/88
D284,668	S		7/1986	Sally et al.	.....	D15/10
D284,767	S		7/1986	Clark et al.	.....	D15/10
D285,081	S		8/1986	Wood	.....	D15/10

FIG. 4 is a left side view of the planter row unit shank mounting bracket design of FIG. 1.

FIG. 5 is a rear view of the planter row unit shank mounting bracket design of FIG. 1.

FIG. 6 is a right side view of the planter row unit shank mounting bracket design of FIG. 1.

**OTHER PUBLICATIONS**

Excerpts from Deere & Company brochure entitled "Planter Attachments and Accessories", front and back cover pp. 4-7, and p. 11, DKA139, printed in U.S.A.

FIG. 7 is a front view of the planter row unit shank mounting bracket design of FIG. 1; and,

FIG. 8 is a bottom view of the planter row unit shank mounting bracket design of FIG. 1.

\* cited by examiner

**1 Claim, 4 Drawing Sheets**

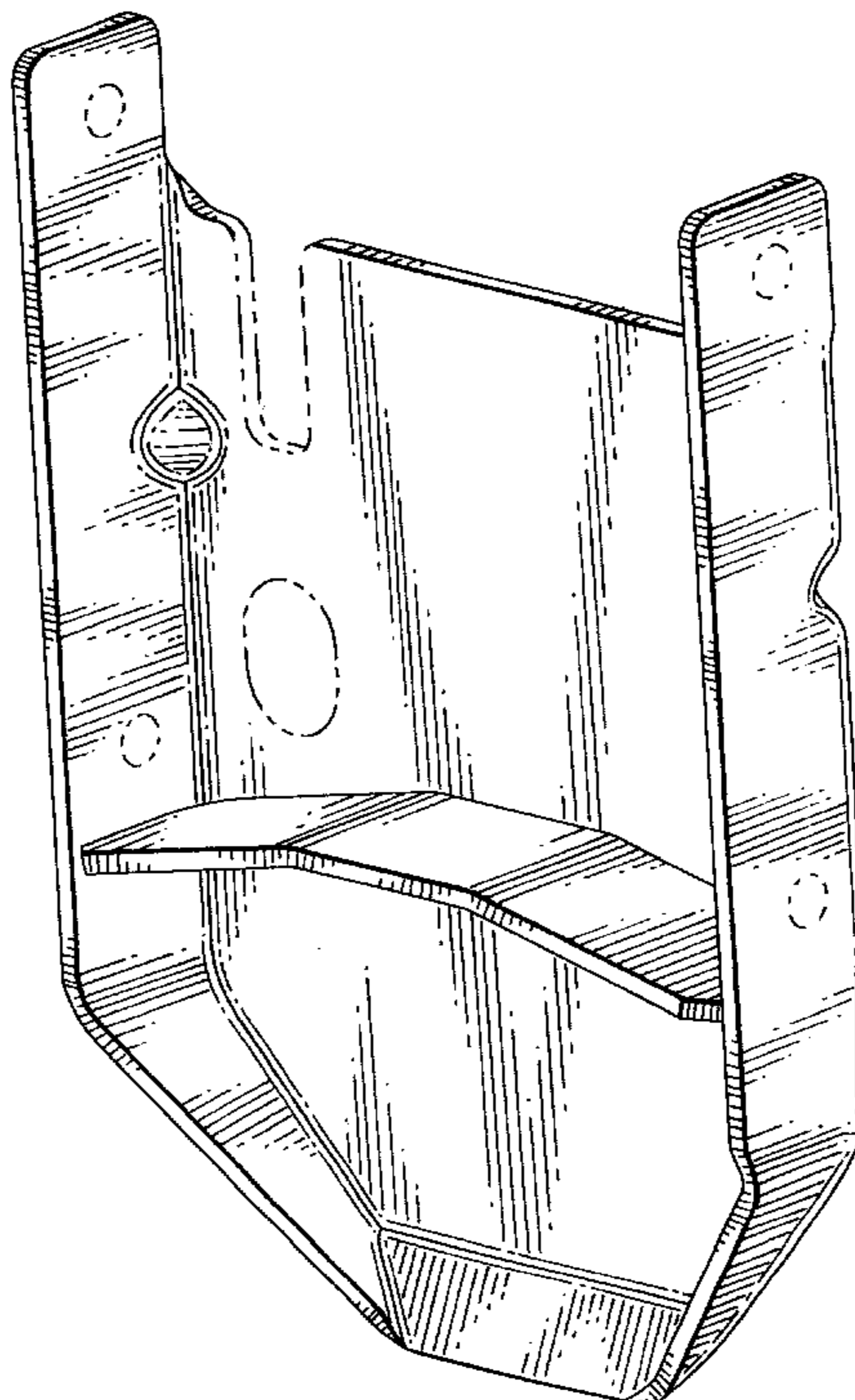

*Fig. 1*

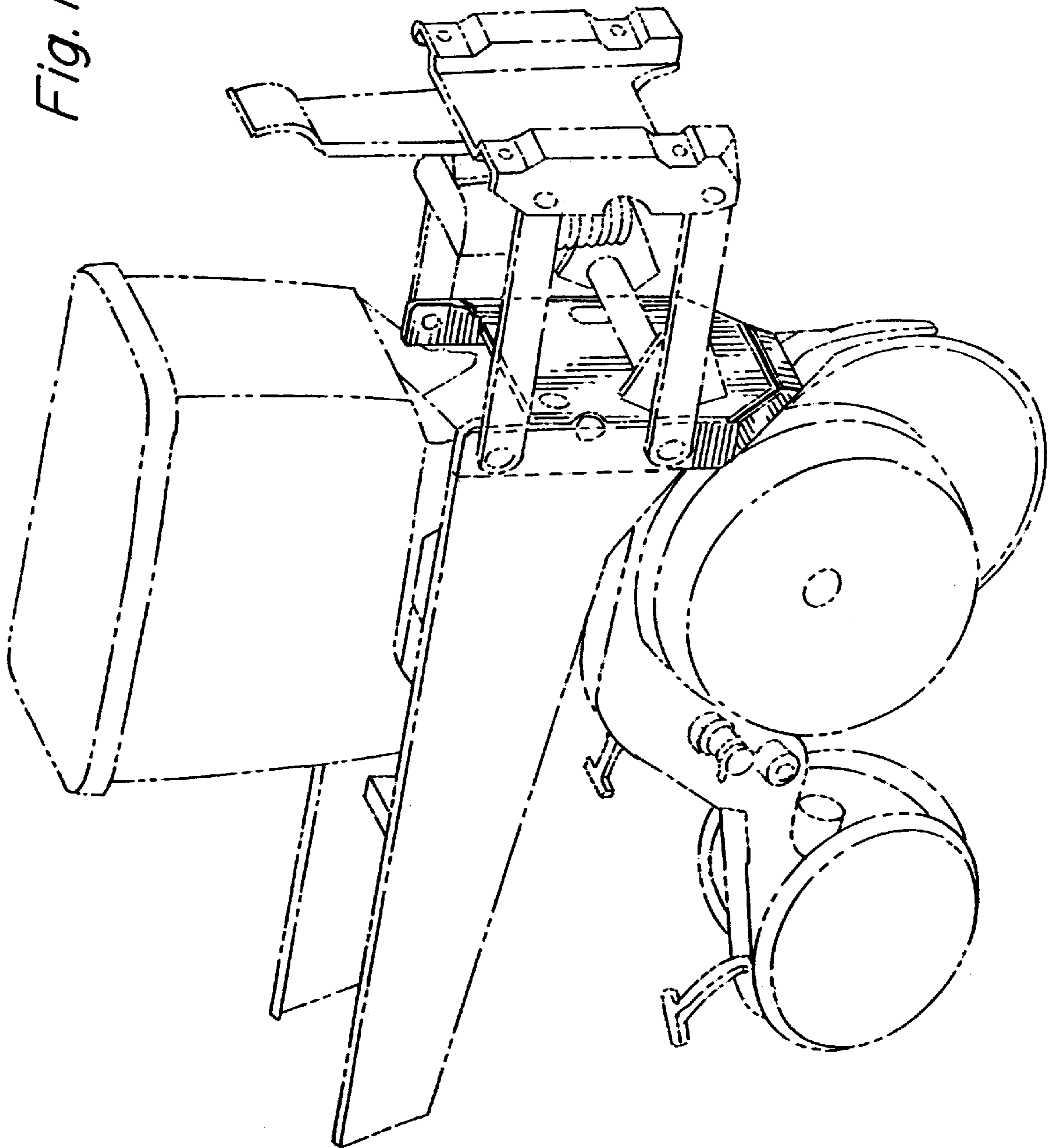

*Fig. 2*

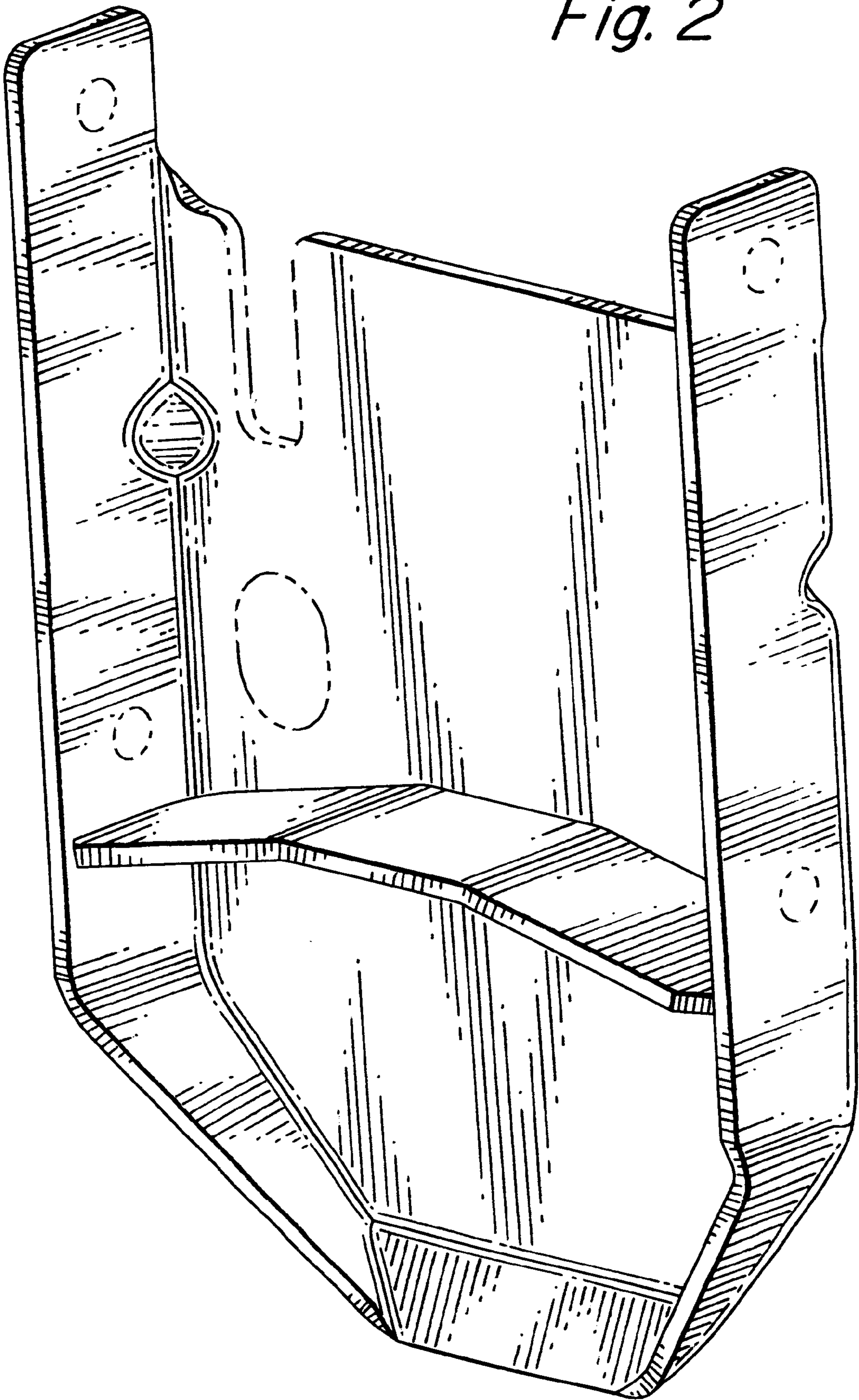

*Fig. 3*

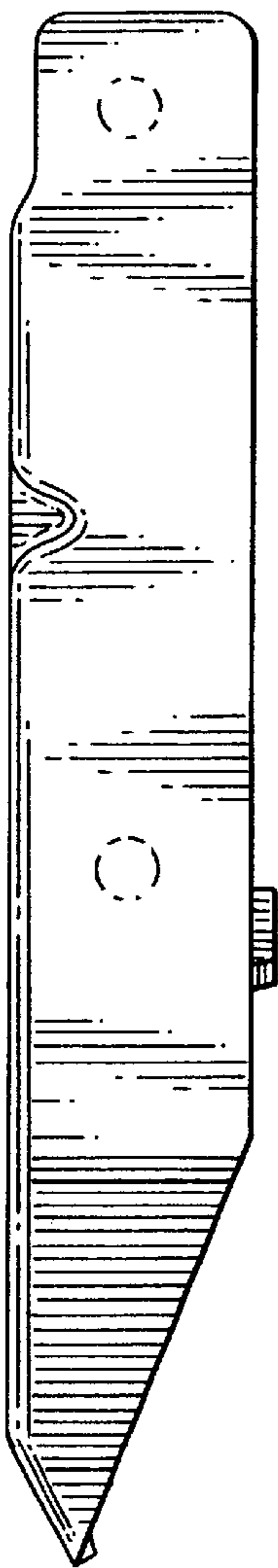
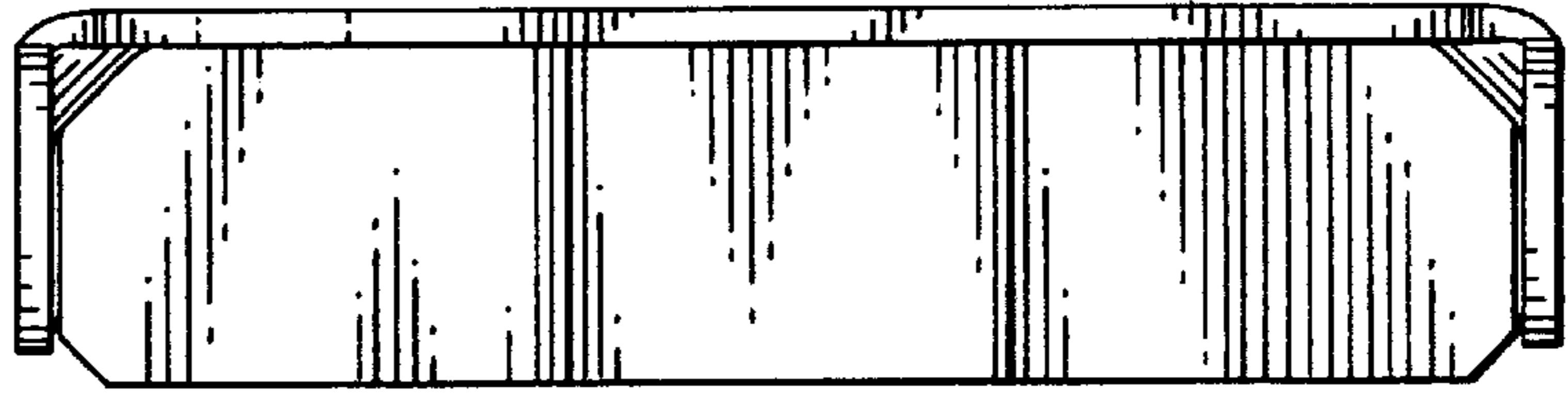

*Fig. 4*

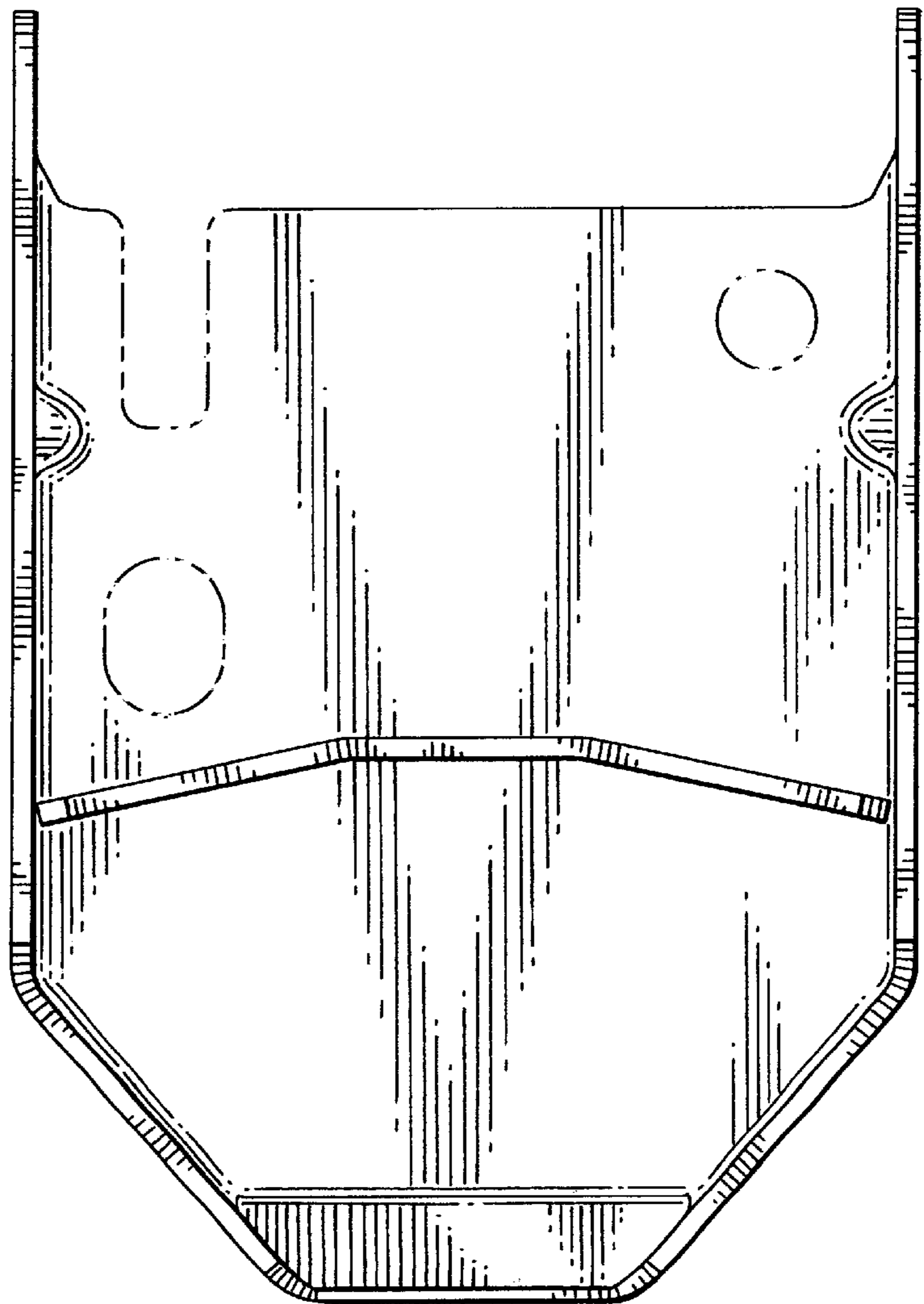

*Fig. 5*

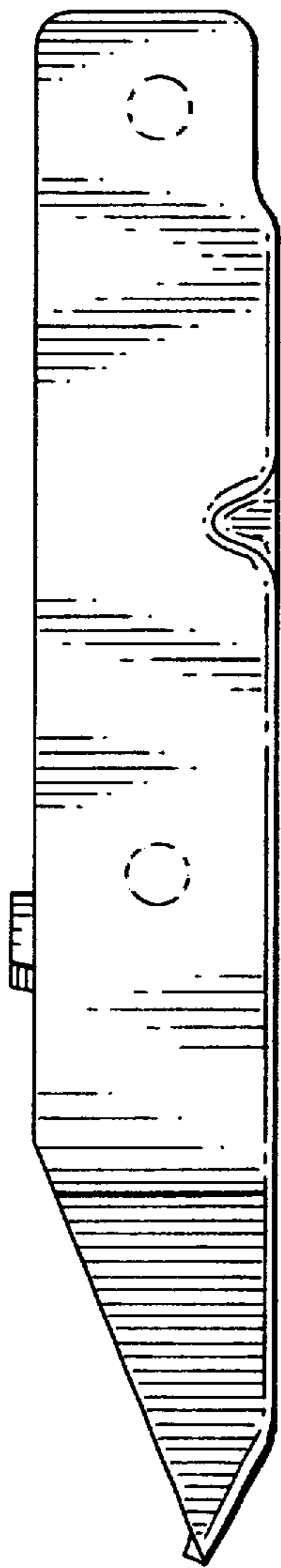

*Fig. 6*

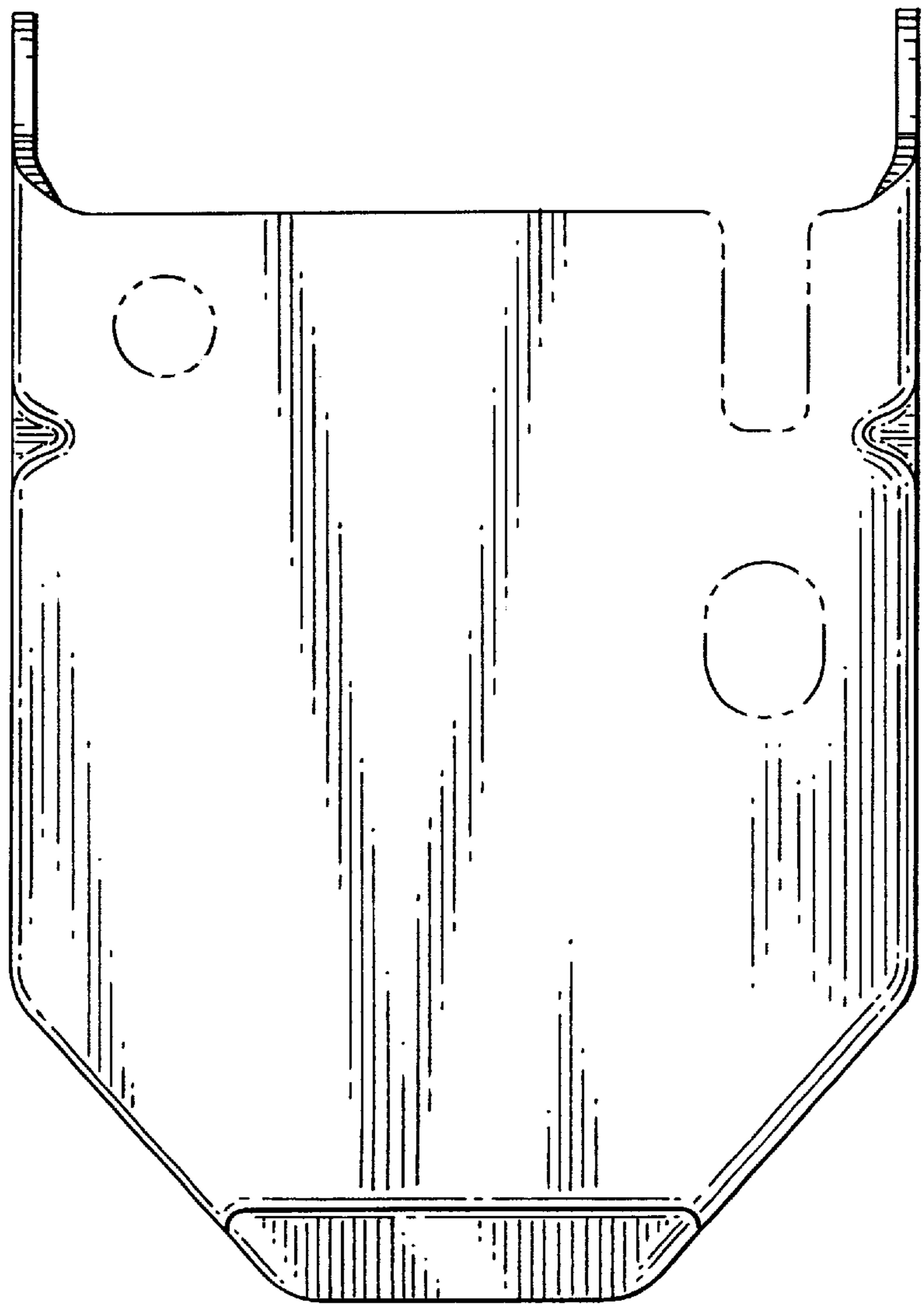

*Fig. 7*

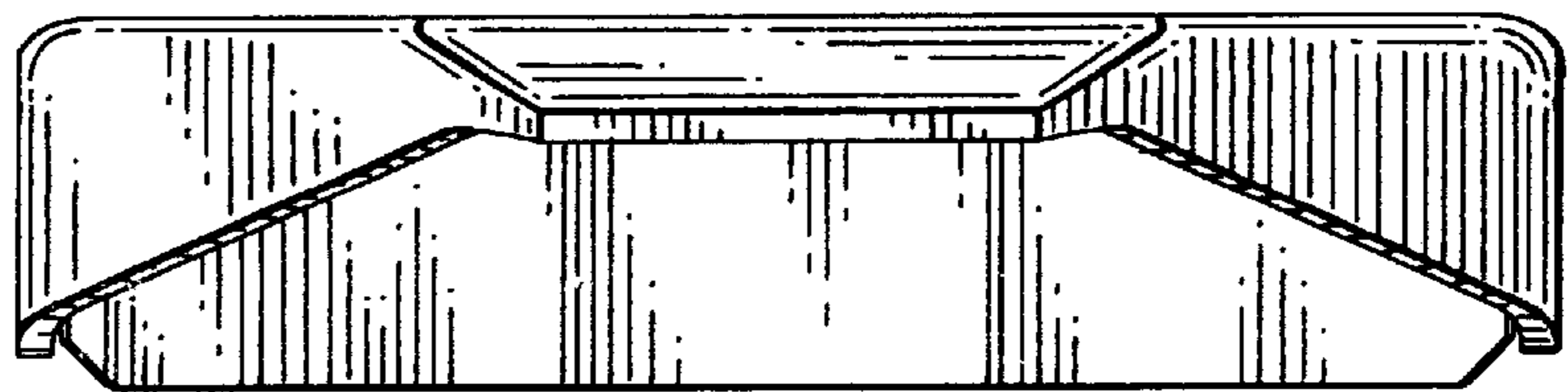

*Fig. 8*