



US00D457095S

(12) **United States Design Patent** (10) **Patent No.:** **US D457,095 S**
Lai (45) **Date of Patent:** **** May 14, 2002**

(54) **JEWELRY SETTING**

(75) Inventor: **Danny S. Lai**, New York, NY (US)

(73) Assignee: **Gramercy Jewelry Manufacturing Corp.**, New York, NY (US)

(**) Term: **14 Years**

(21) Appl. No.: **29/143,295**

(22) Filed: **Jun. 11, 2001**

Related U.S. Application Data

(62) Division of application No. 29/127,555, filed on Aug. 7, 2000, now Pat. No. Des. 443,554.

(51) **LOC (7) Cl.** **11-01**

(52) **U.S. Cl.** **D11/92**

(58) **Field of Search** D11/1, 2, 7, 8, D11/26, 27, 30-34, 36, 48, 40, 79, 89-92, 86, 75; 6/26-28, 29.1, 32, 12-15, 3, 4

(56) **References Cited**

U.S. PATENT DOCUMENTS

D114,649 S	5/1939	Simon
2,907,187 A	10/1959	Karp et al.
5,123,265 A	6/1992	Ramot
5,377,506 A	1/1995	Tranzer

(List continued on next page.)

Primary Examiner—Louis S. Zarfes

Assistant Examiner—Deanne Levy

(74) *Attorney, Agent, or Firm*—Baker Botts L.L.P.

(57) **CLAIM**

The ornamental design of a jewelry setting, as shown and described.

DESCRIPTION

FIG. 1 is a perspective view of a first embodiment of a jewelry setting of my new design shown in a position of use in a pin;

FIG. 2 is a top view of the jewelry setting of FIG. 1 shown in a position of use in a ring;

FIG. 3 is a first side view of the jewelry setting of FIG. 2; FIG. 4 is a second side view of the jewelry setting of FIG. 2;

FIG. 5 is a perspective view of a second embodiment of the jewelry setting of my new design shown in a position of use in a pin;

FIG. 6 is a top view of the jewelry setting of FIG. 5 shown in a position of use in a ring;

FIG. 7 is a first side view of the jewelry setting of FIG. 6; FIG. 8 is a second side view of the jewelry setting of FIG. 6;

FIG. 9 is a perspective view of a third embodiment of the jewelry setting of my new design shown in a position of use in a pin;

FIG. 10 is a top view of the jewelry setting of FIG. 9 shown in a position of use in a ring;

FIG. 11 is a first side view of the jewelry setting of FIG. 10; FIG. 12 is a second side view of the jewelry setting of FIG. 10;

FIG. 13 is a perspective view of a fourth embodiment of the jewelry setting of my new design shown in a position of use in a pin;

FIG. 14 is a top view of the jewelry setting of FIG. 13 shown in a position of use in a ring;

FIG. 15 is a first side view of the jewelry setting of FIG. 14; FIG. 16 is a second side view of the jewelry setting of FIG. 14;

FIG. 17 is a perspective view of a fifth embodiment of the jewelry setting of my new design shown in a position of use in a pin;

FIG. 18 is a top view of the jewelry setting of FIG. 17 shown in a position of use in a ring;

FIG. 19 is a first side view of the jewelry setting of FIG. 18; and,

FIG. 20 is a second side view of the jewelry setting of FIG. 18.

The broken lines are provide for illustrative purposes only and form no part of the claimed design.

1 Claim, 10 Drawing Sheets

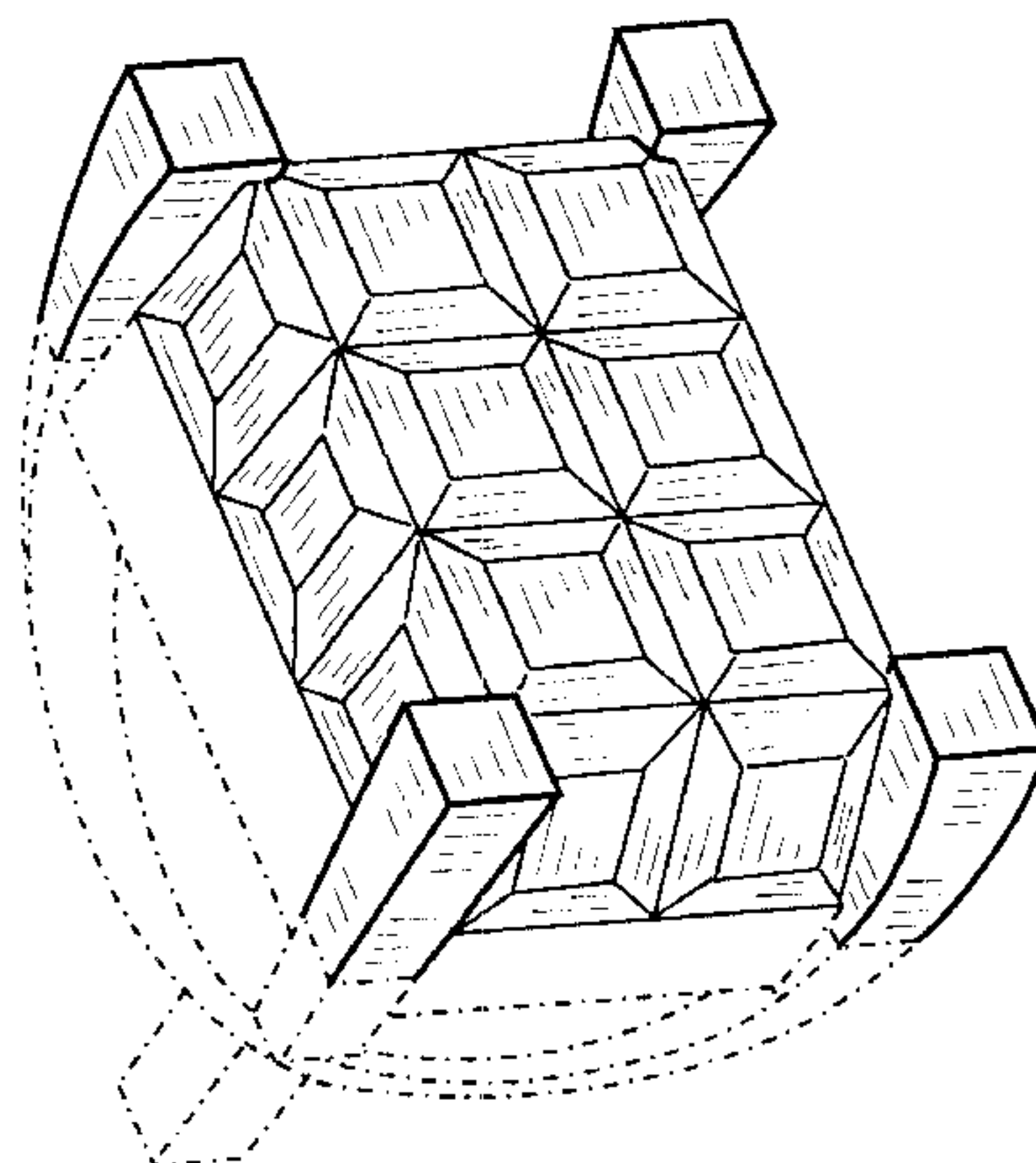

US D457,095 S

Page 2

U.S. PATENT DOCUMENTS

5,520,017 A	5/1996	Vivat	6,026,660 A	2/2000	Lai	
D379,601 S	6/1997	Itzkowitz	D425,817 S	5/2000	Gurevich et al.	
D391,516 S	3/1998	Kothari	D427,934 S	6/2000	Lai	
5,848,539 A	12/1998	Ouzounian	D432,448 S	* 10/2000	Lai D11/92
D403,611 S	1/1999	Lai	D440,177 S	* 4/2001	Gruosi D11/26
D411,134 S	6/1999	Lai	D442,514 S	* 5/2001	Chan D11/91
6,003,335 A	12/1999	Gurevich et al.				

* cited by examiner

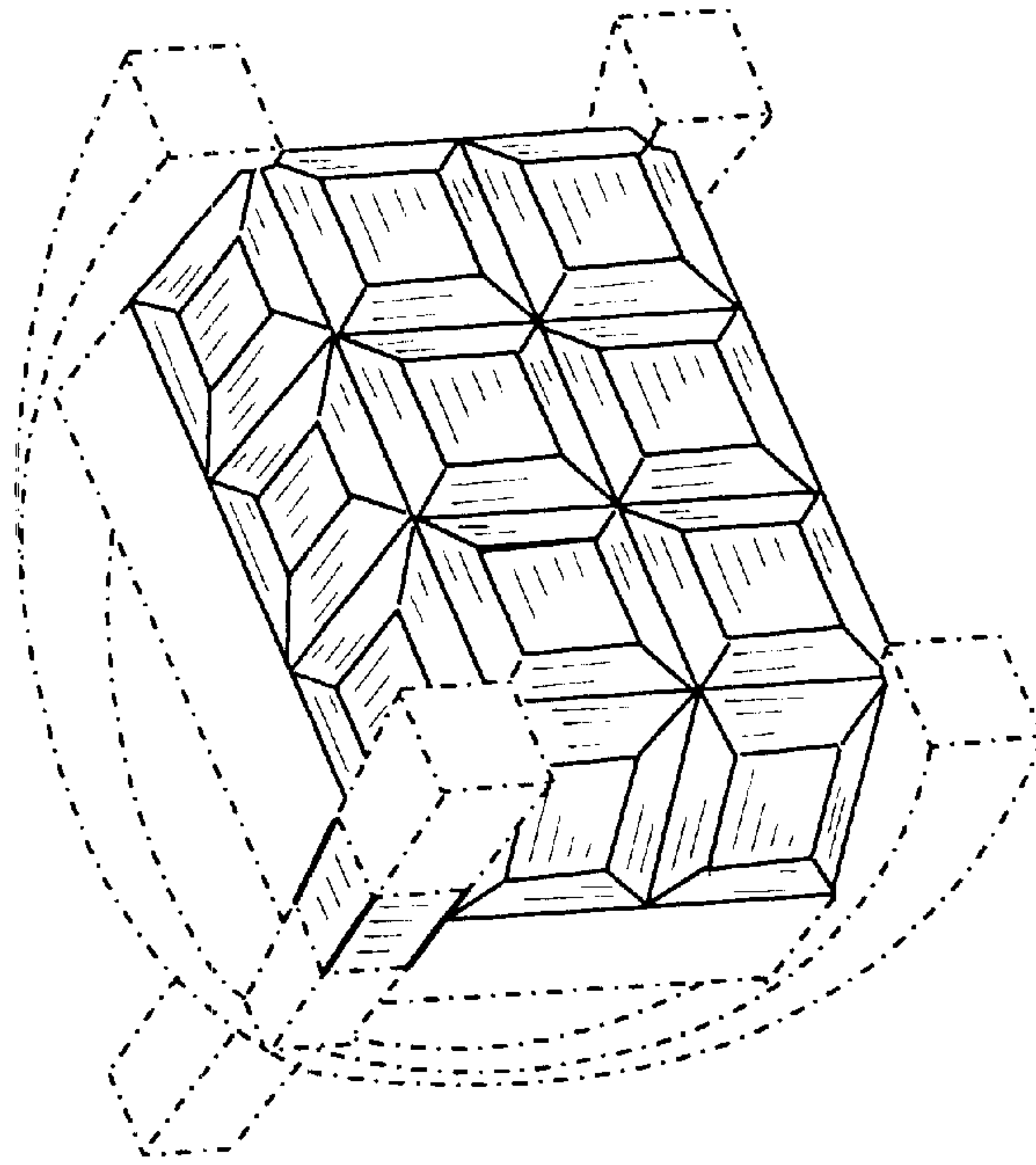

FIG. 1

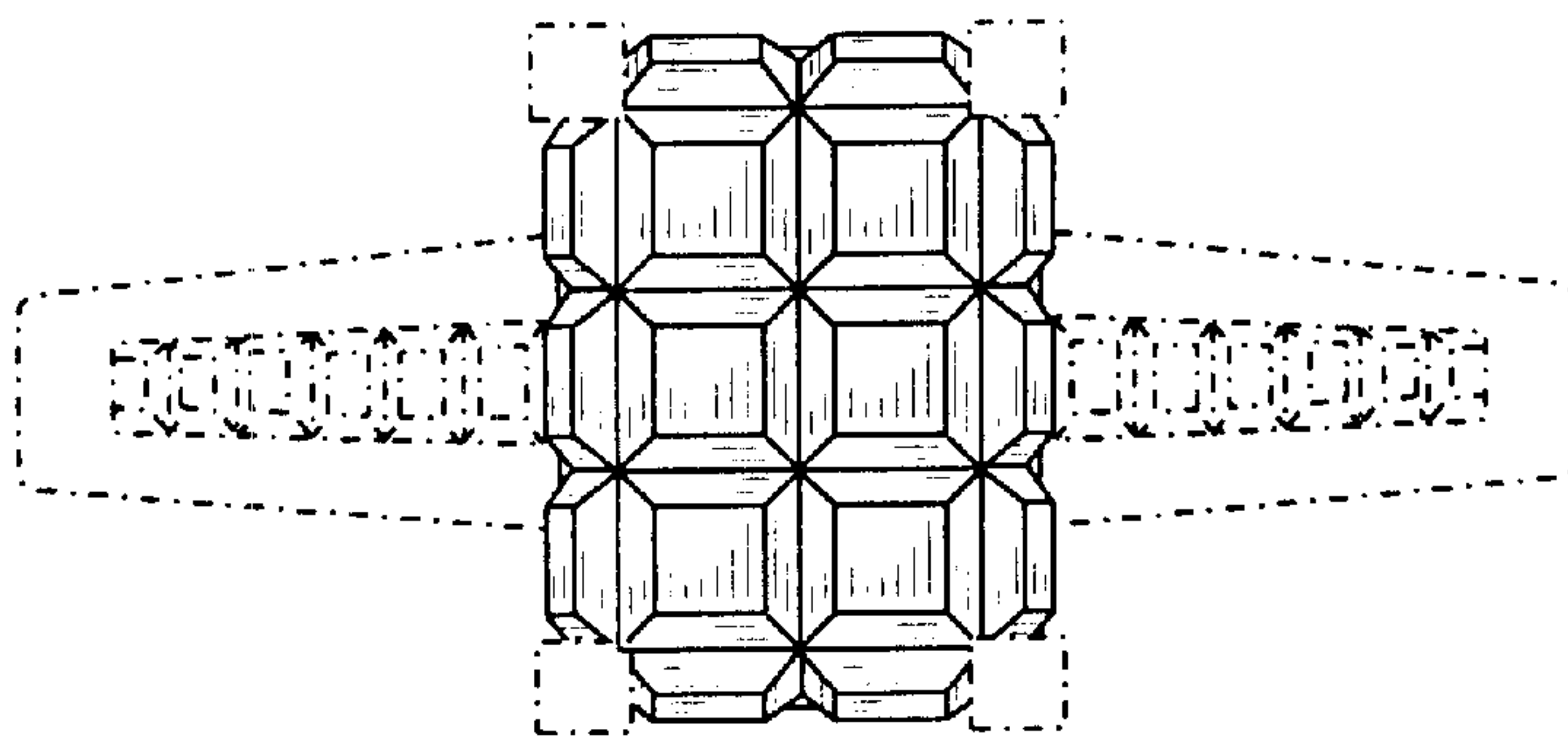

FIG. 2

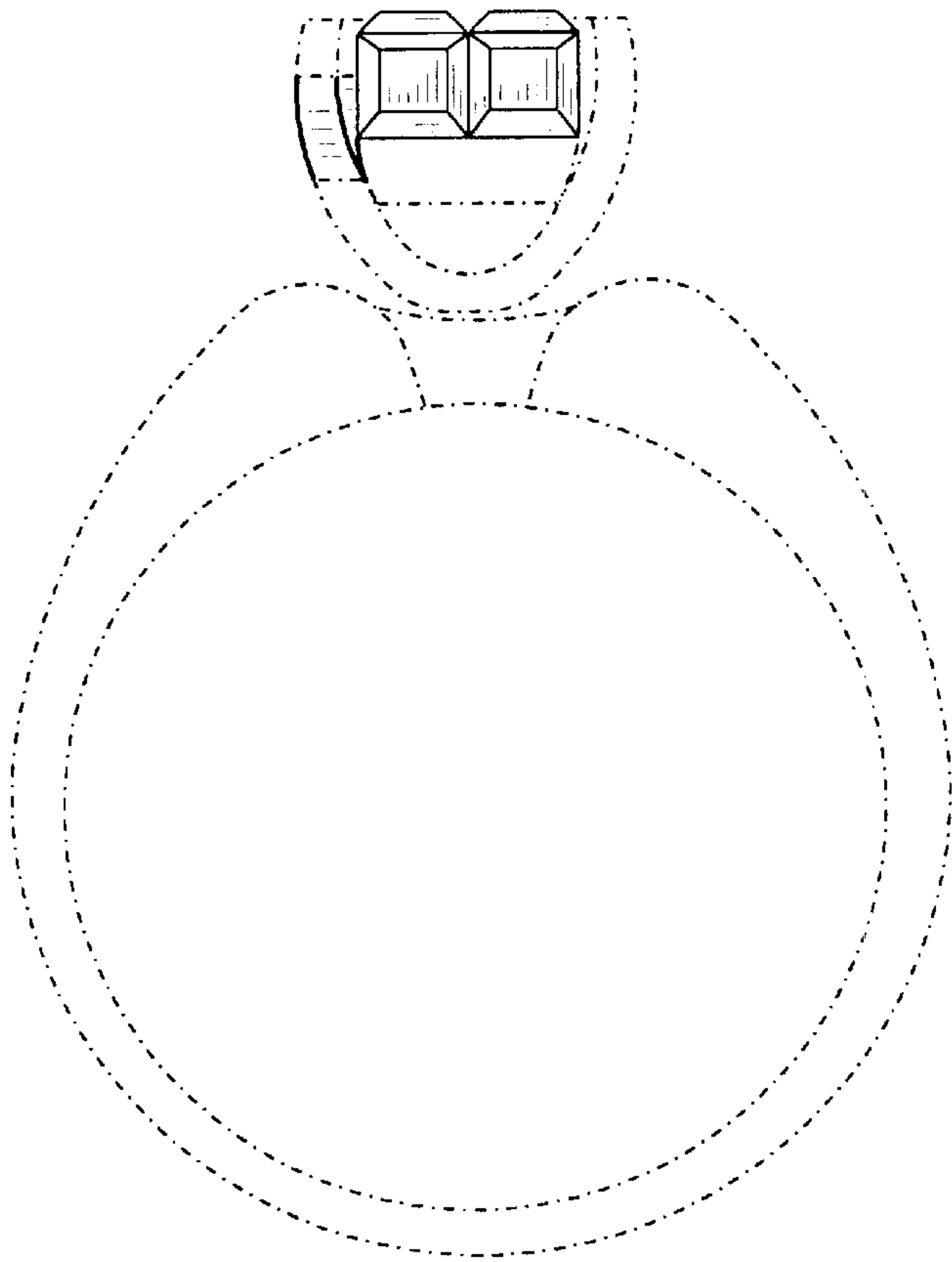

FIG. 3

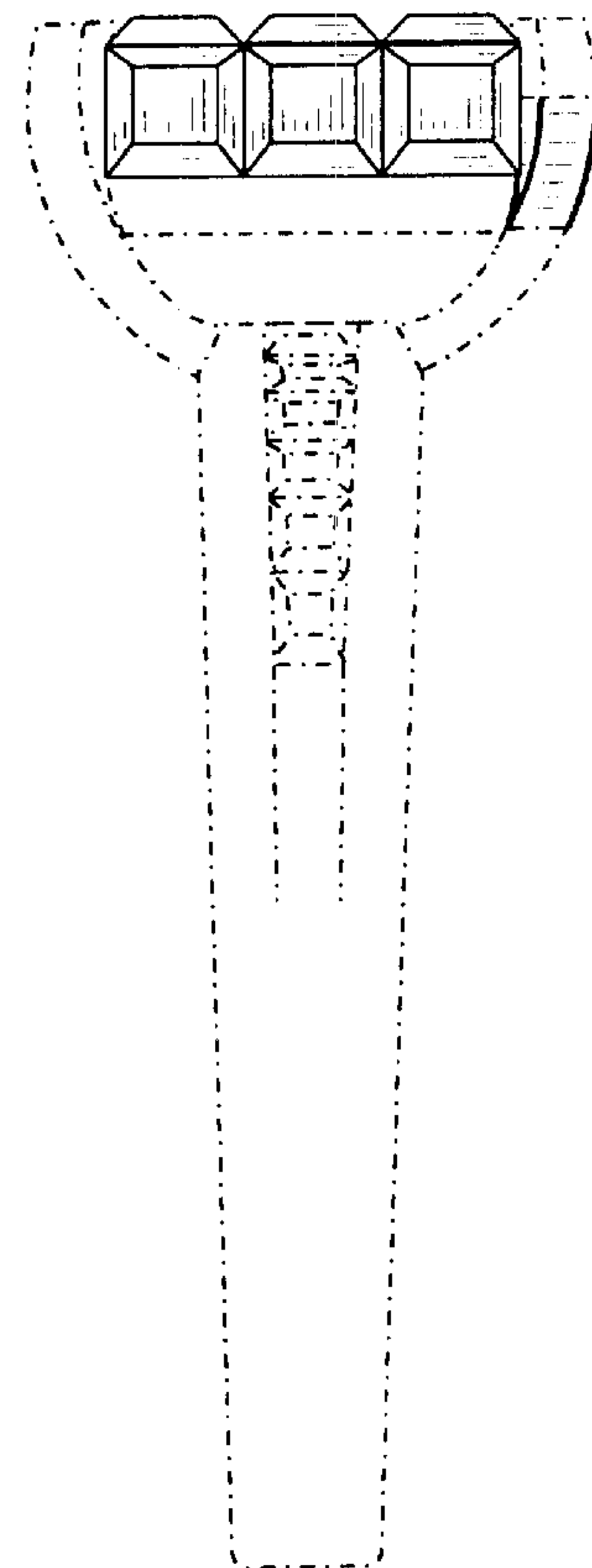

FIG. 4

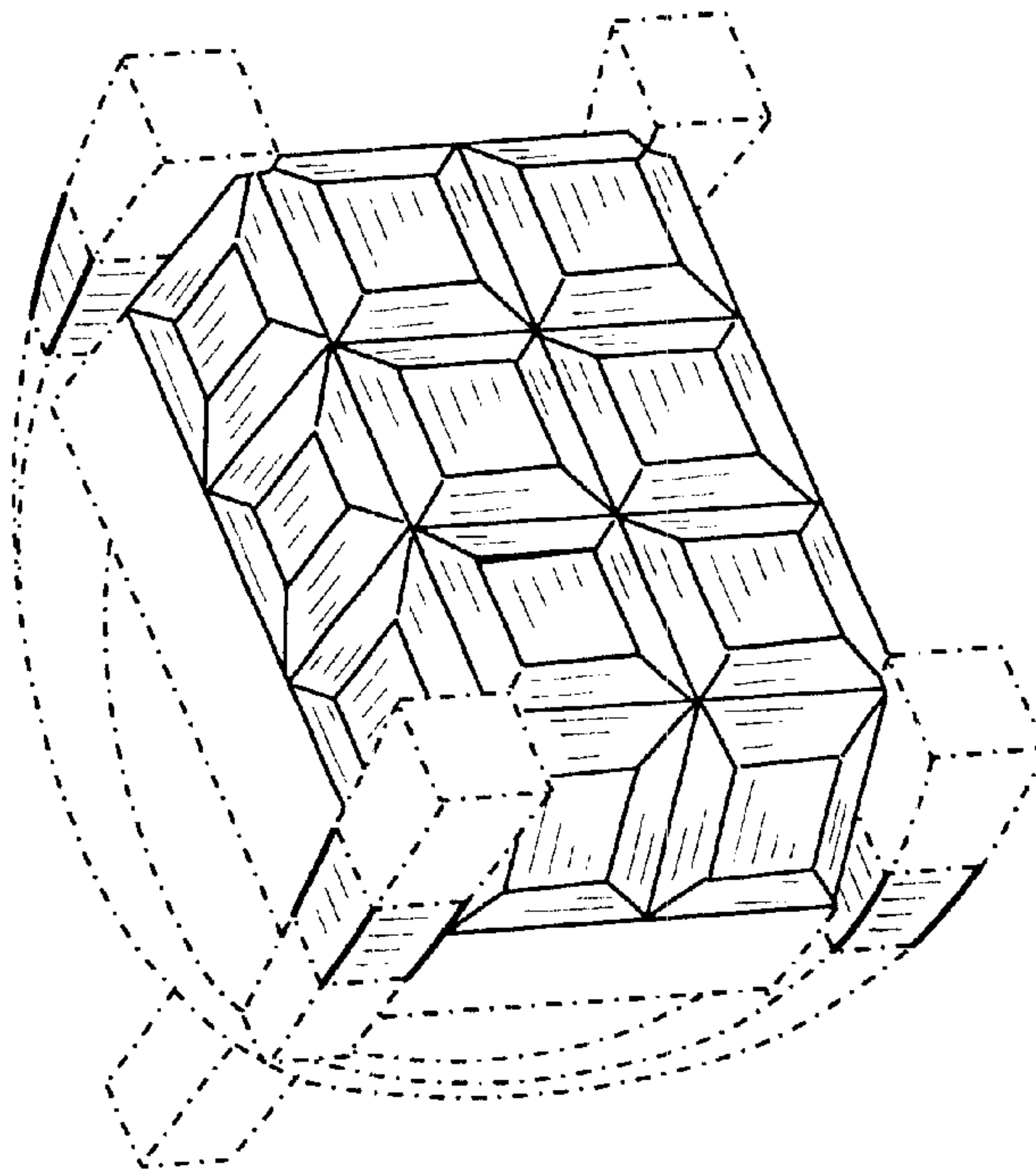

FIG. 5

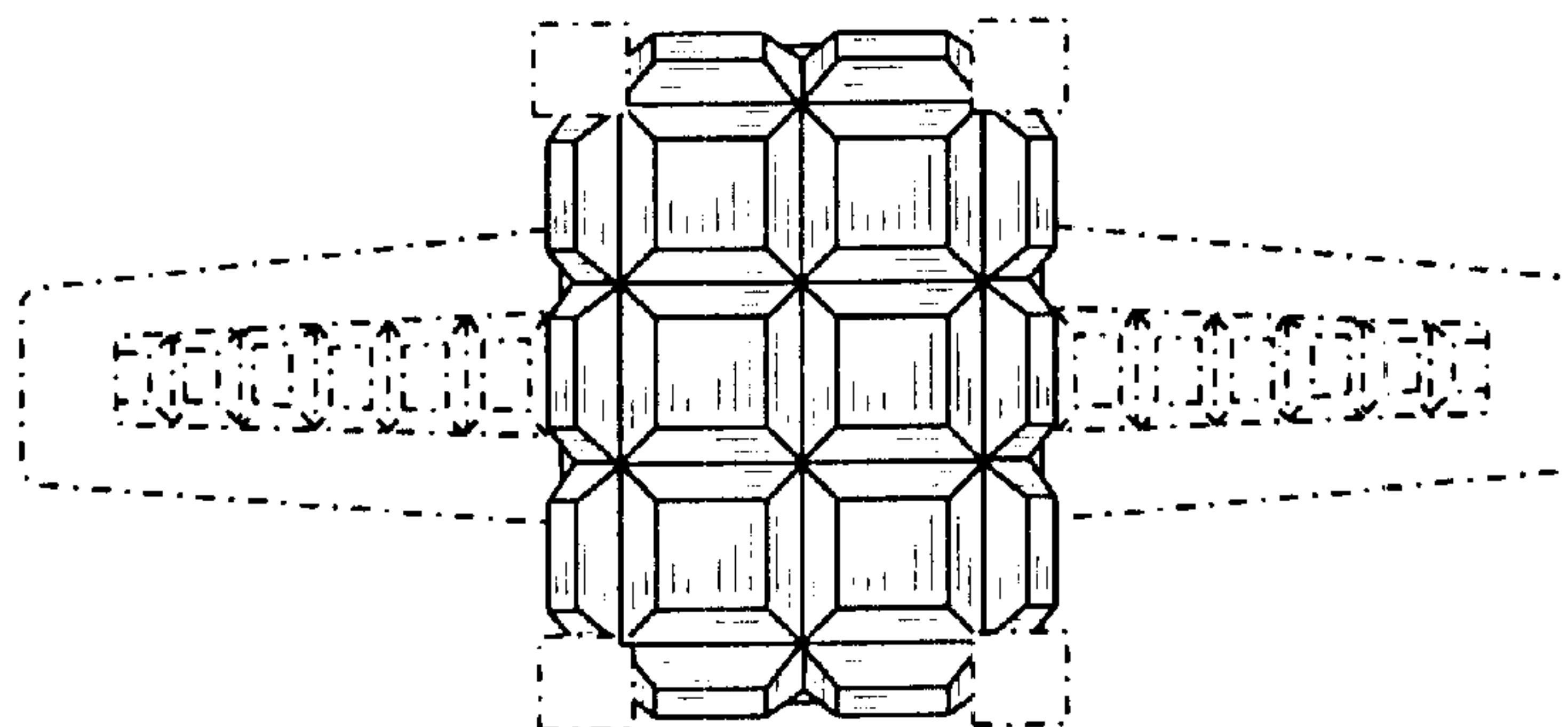

FIG. 6

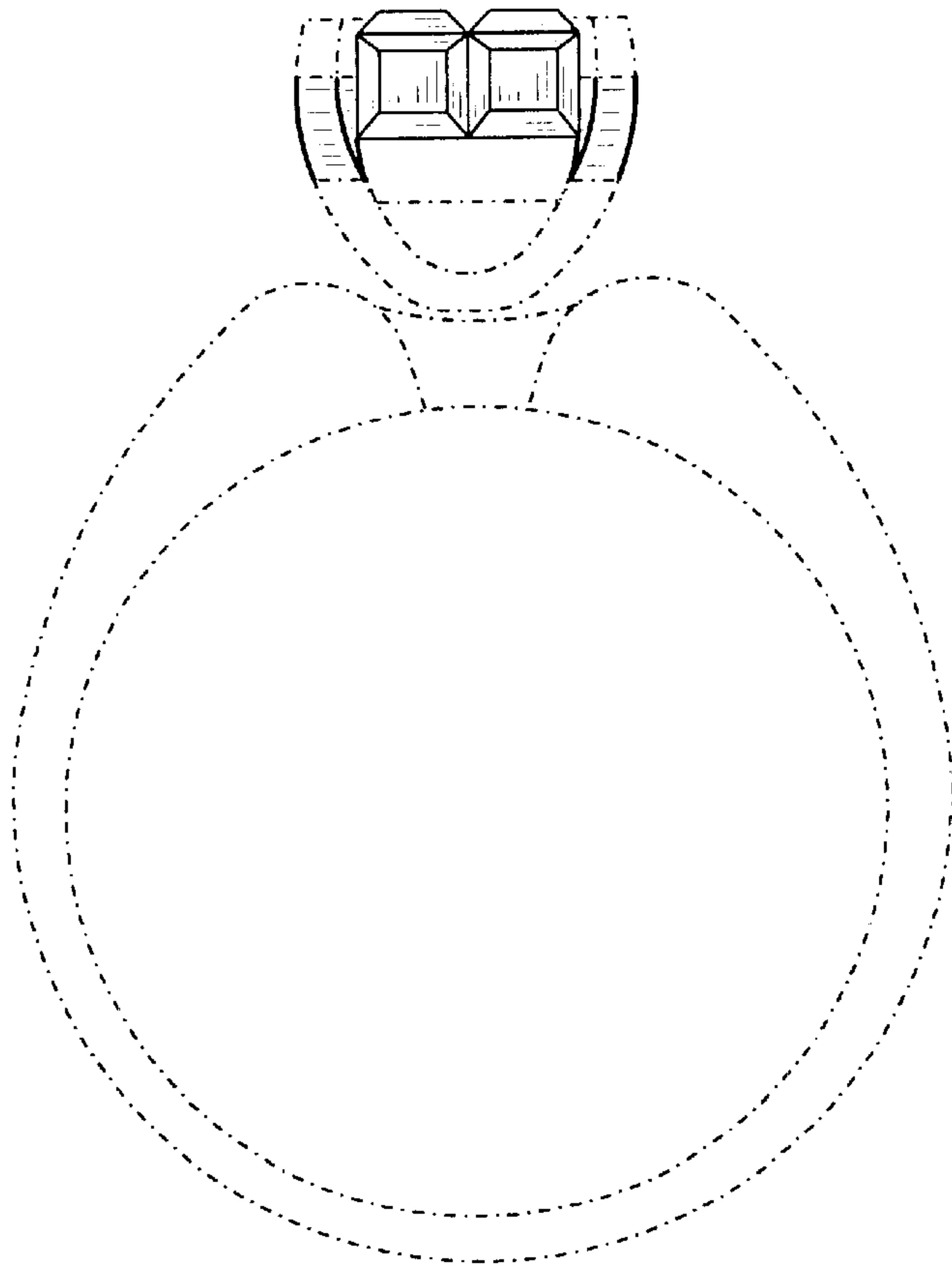

FIG. 7

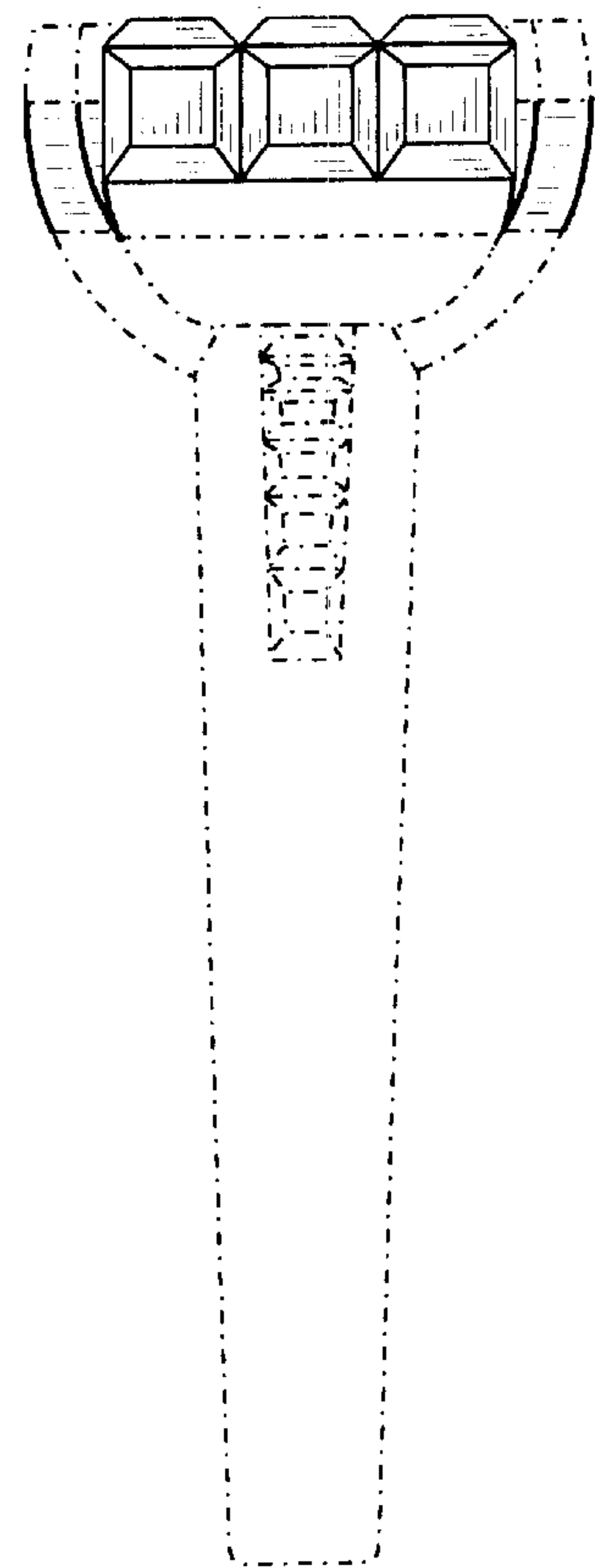

FIG. 8

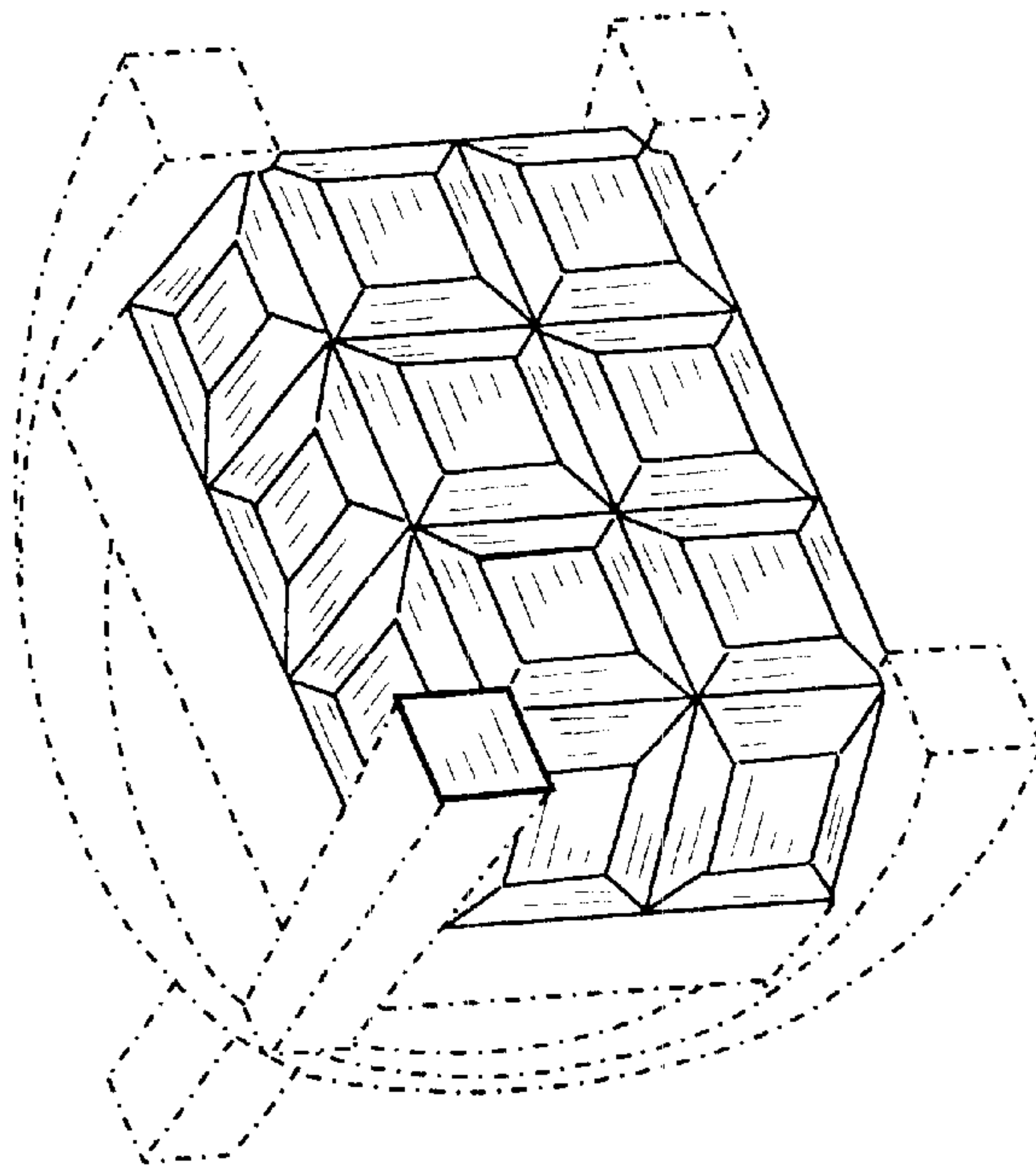

FIG. 9

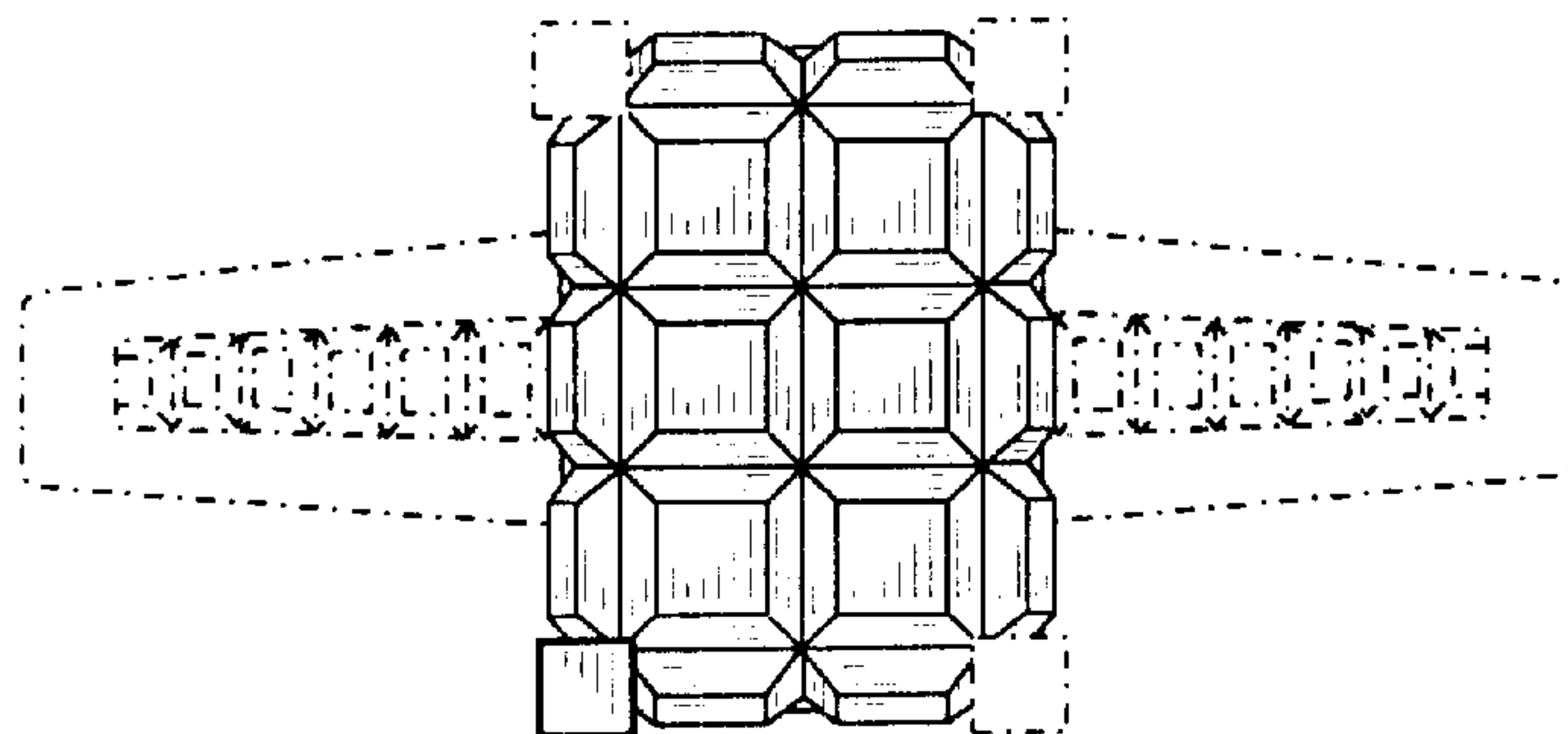

FIG. 10

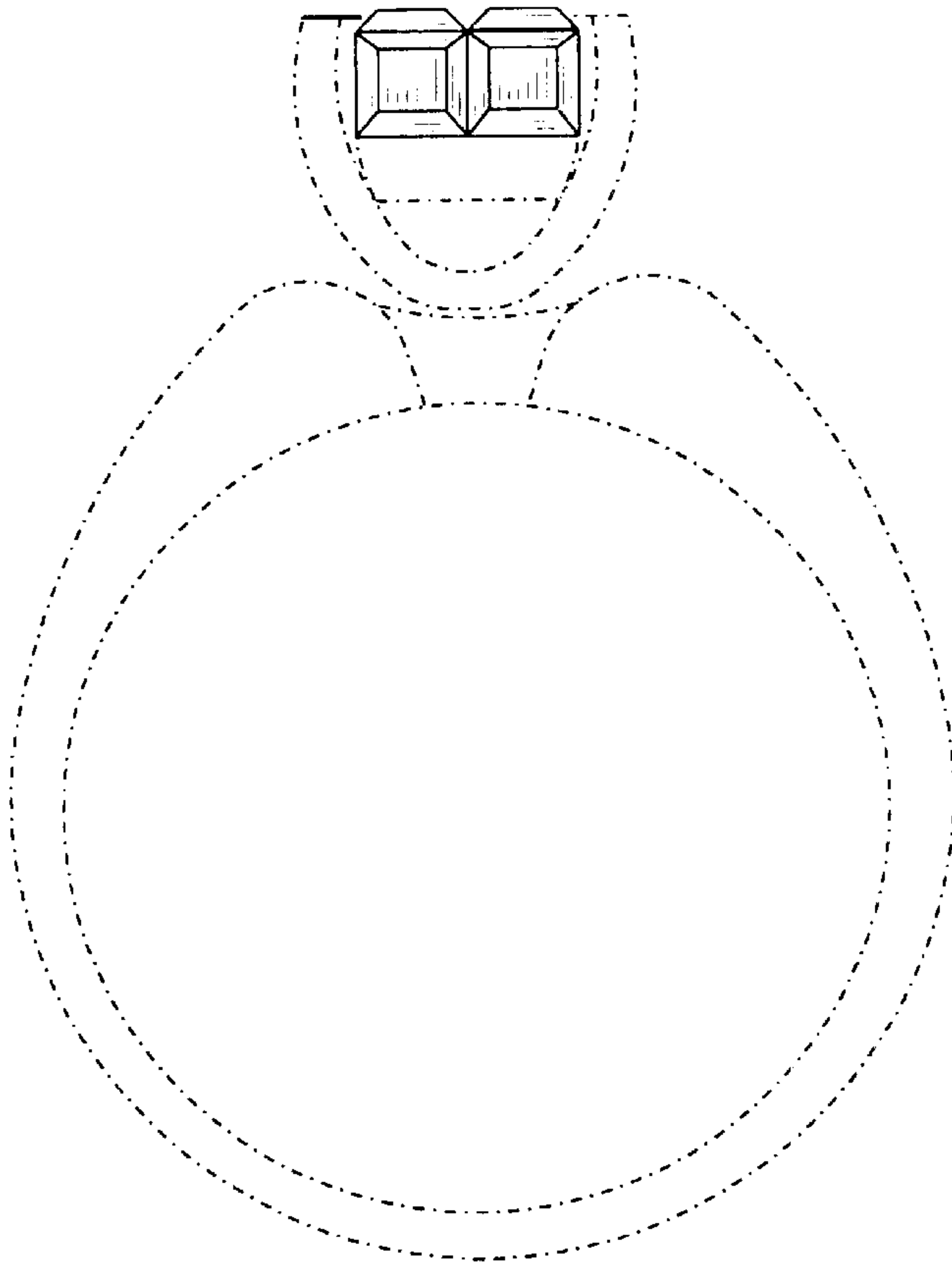

FIG. 11

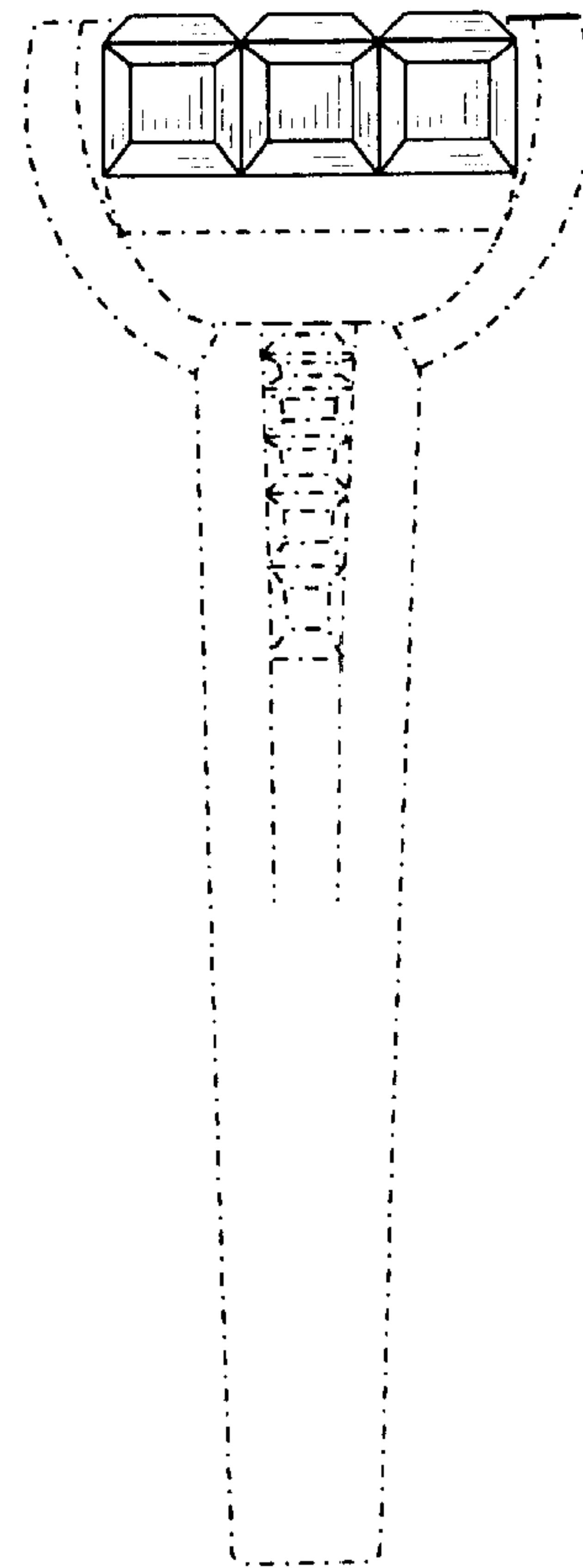

FIG. 12

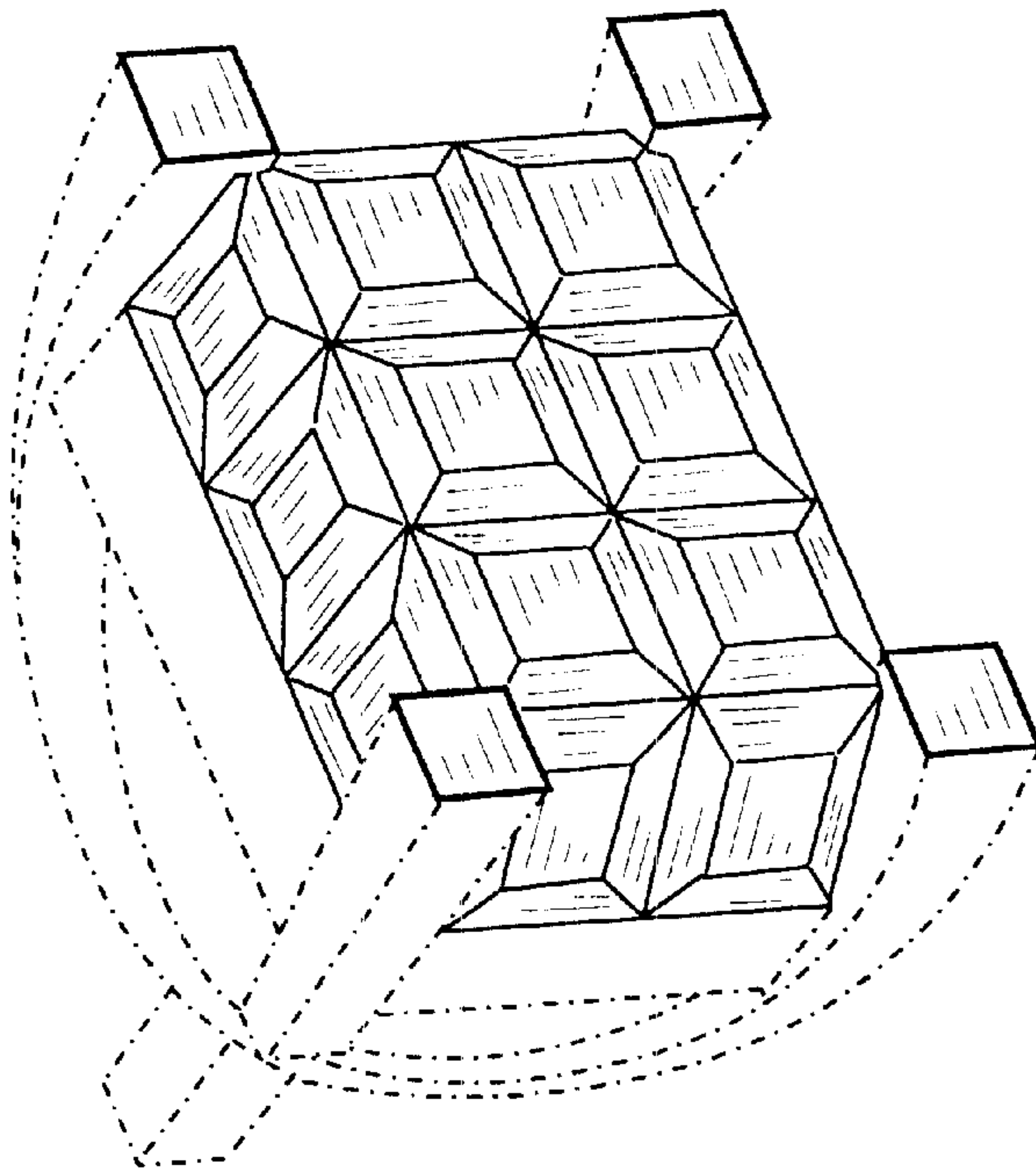

FIG. 13

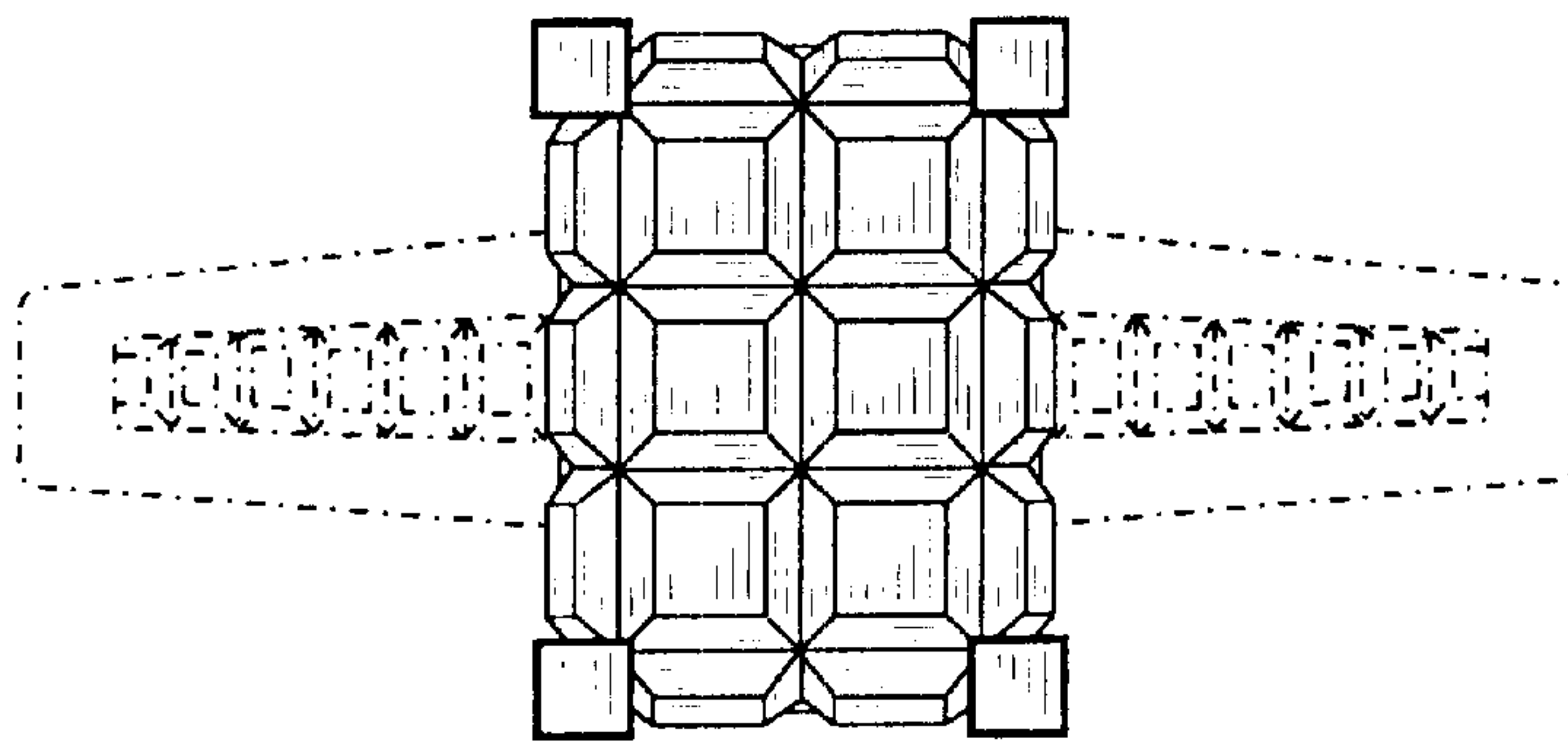

FIG. 14

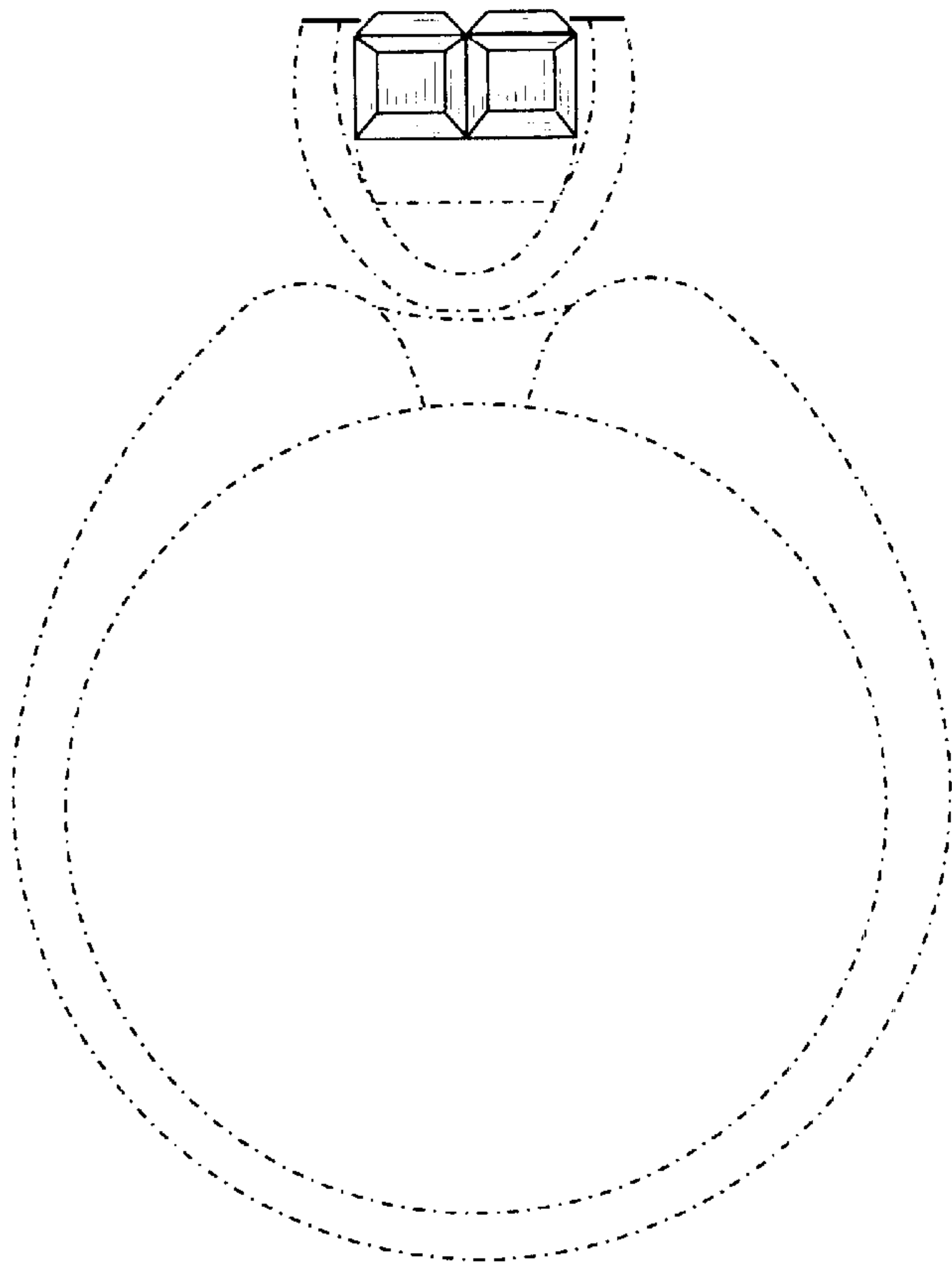

FIG. 15

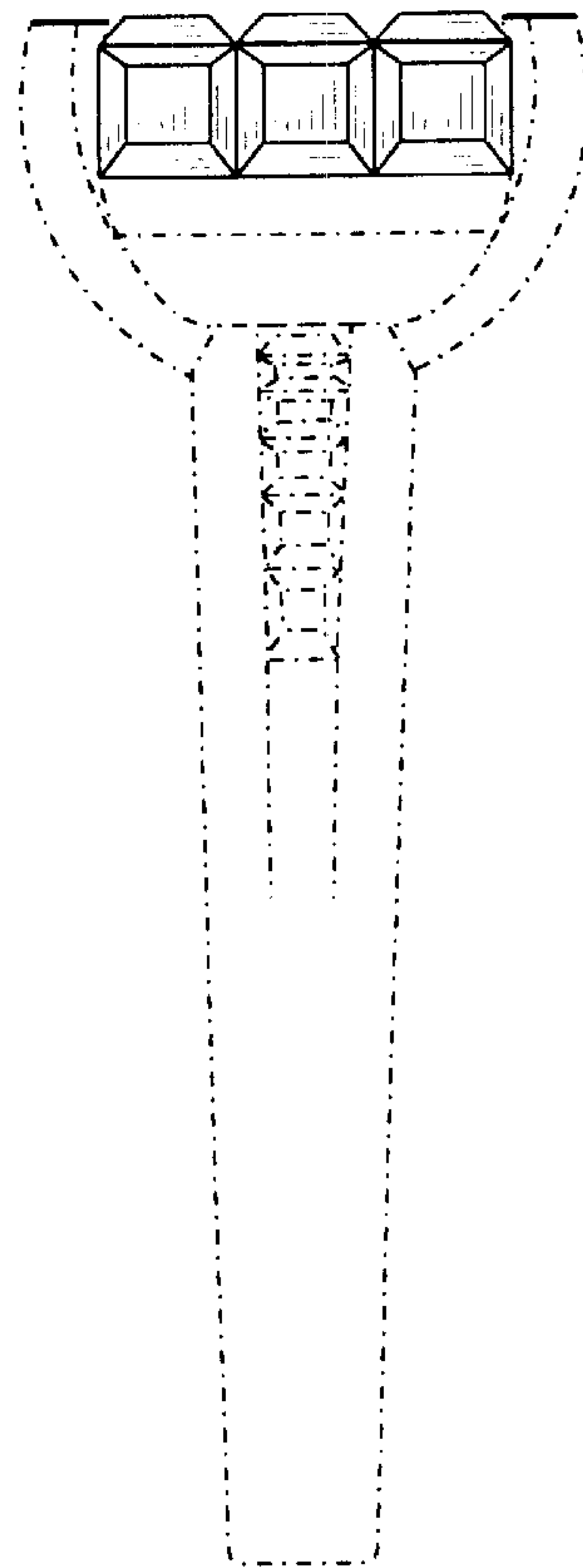

FIG. 16

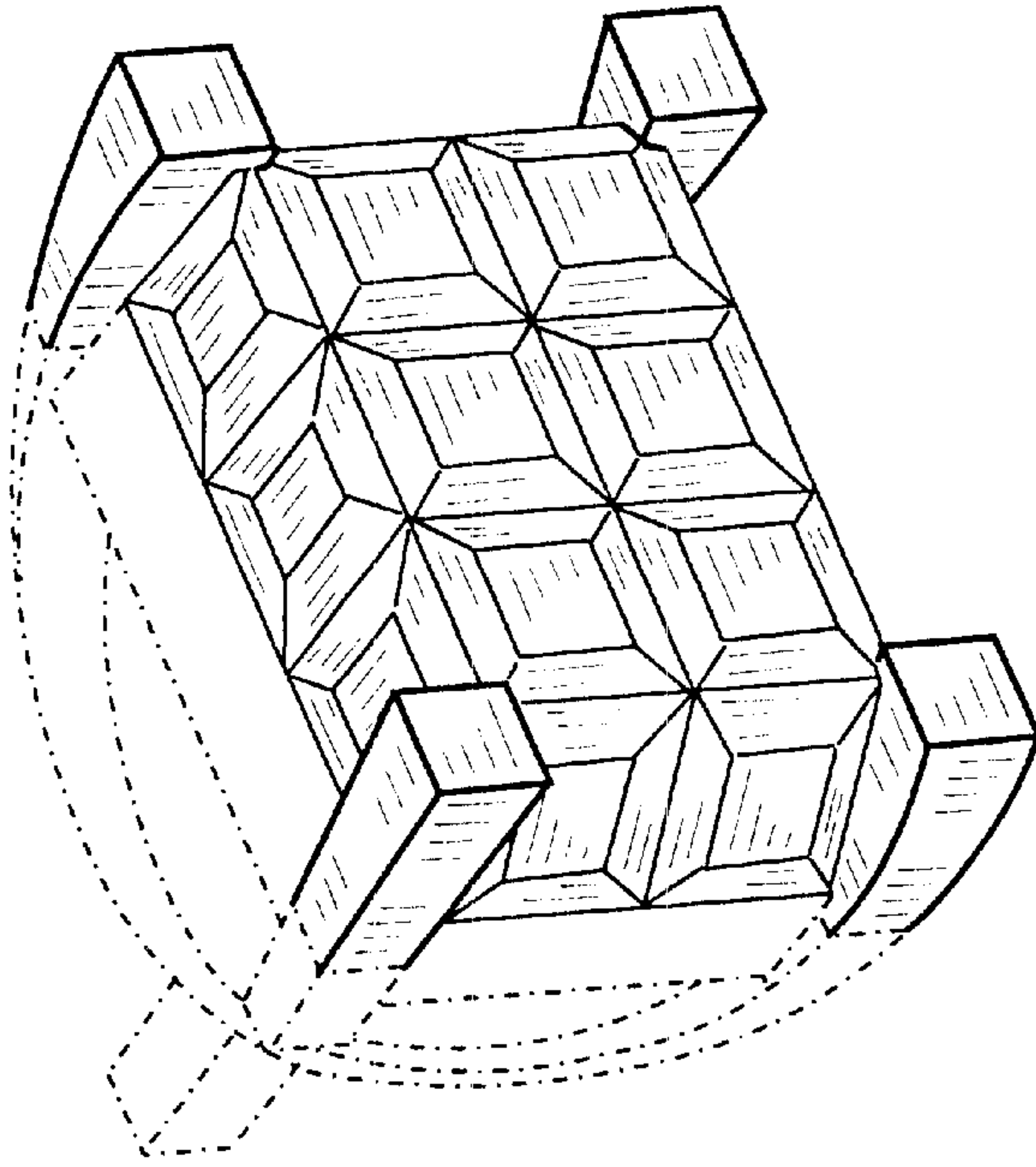

FIG. 17

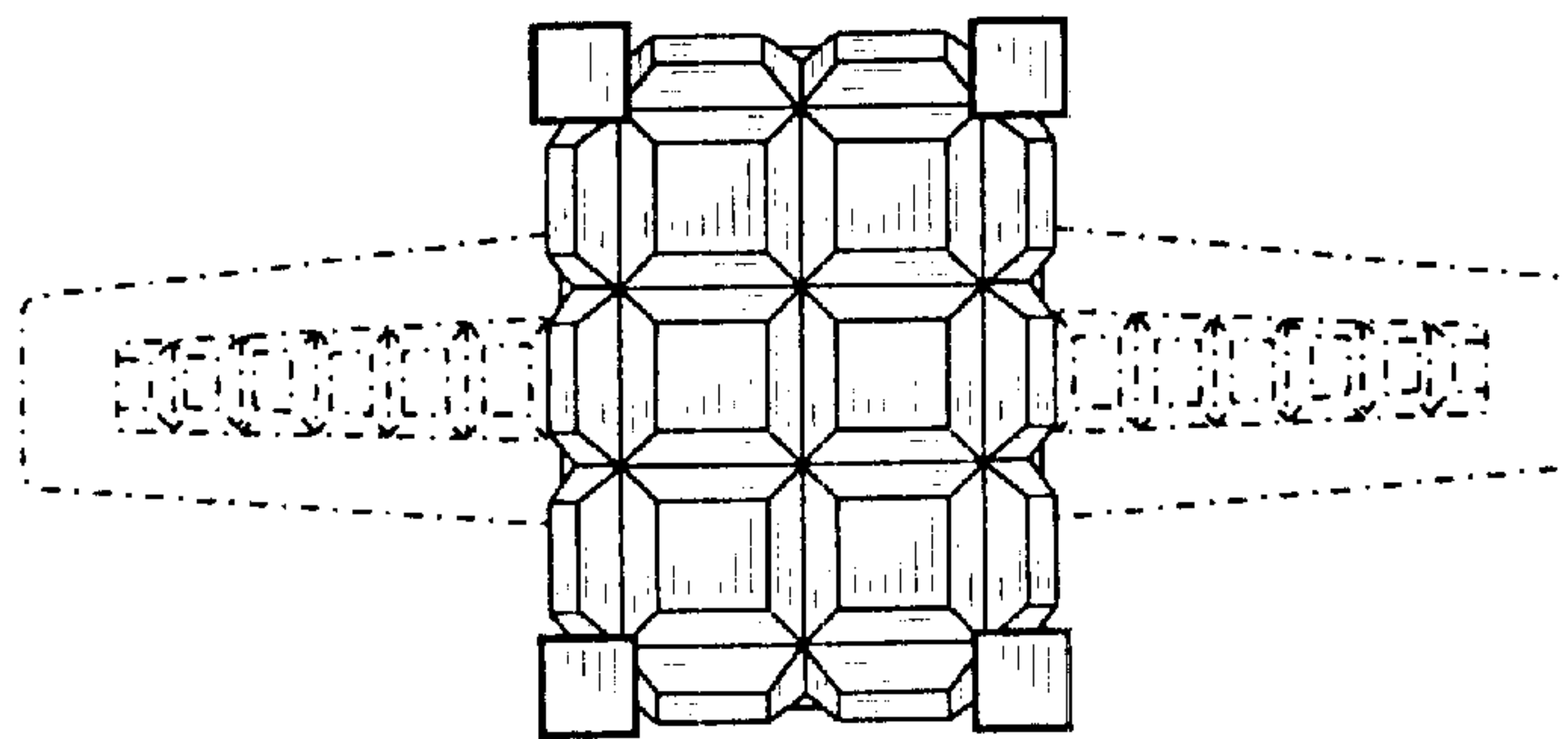

FIG. 18

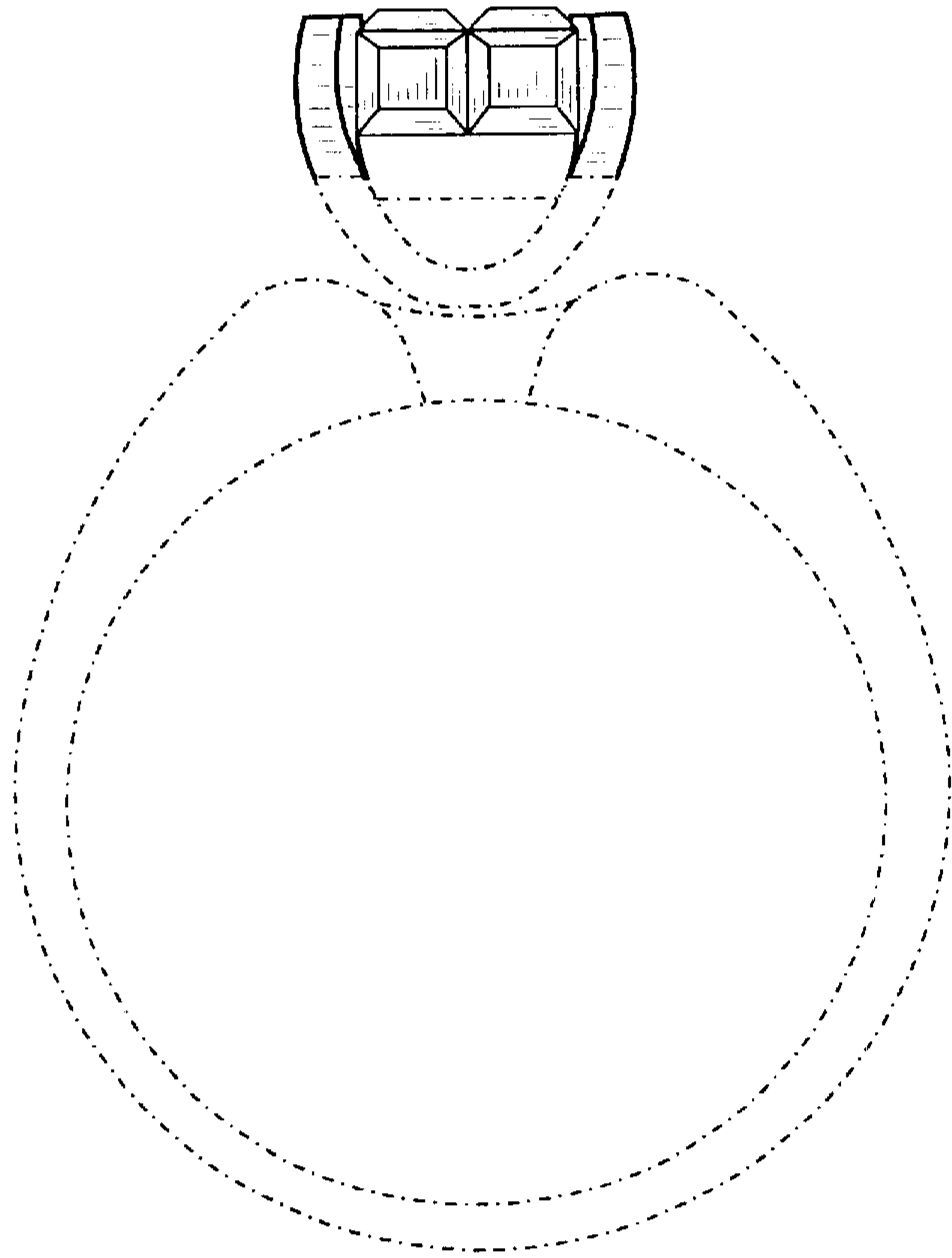

FIG. 19

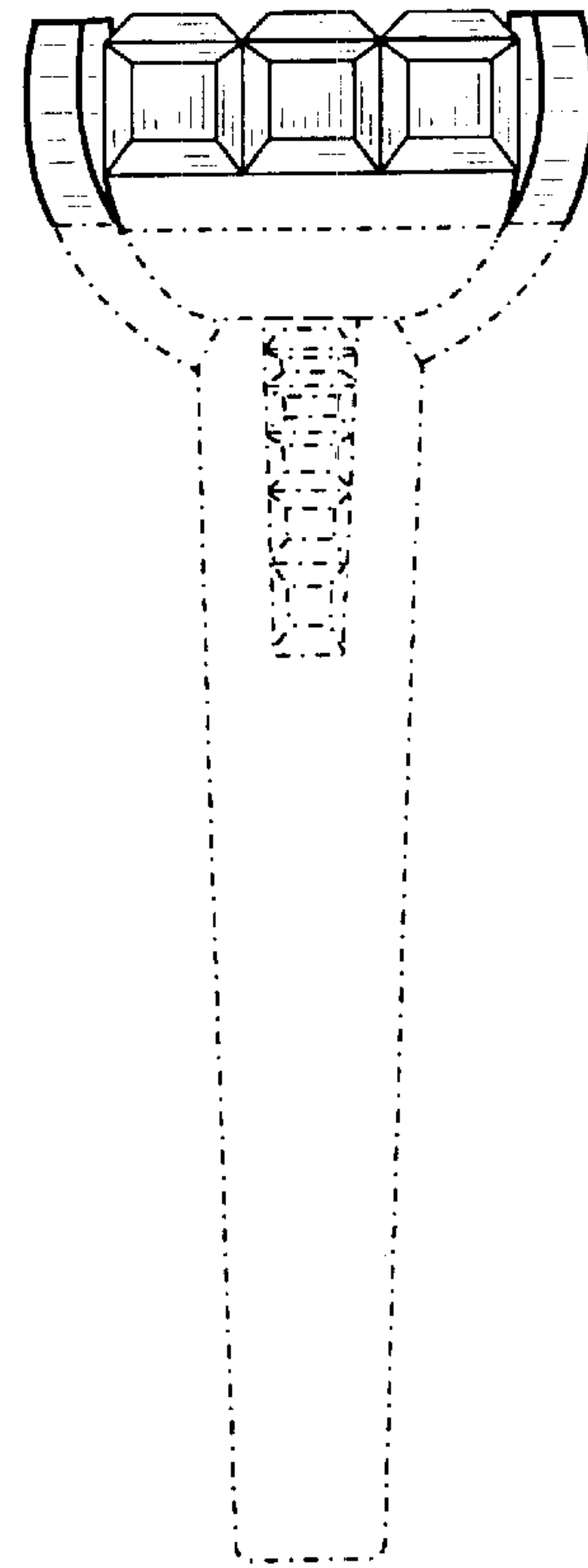

FIG. 20