



US00D457089S

(12) **United States Design Patent**  
**Mistretta**

(10) **Patent No.:** **US D457,089 S**

(45) **Date of Patent:** **\*\* May 14, 2002**

(54) **RING**

(76) Inventor: **Steven S. Mistretta**, 502 Deerpath Dr.,  
McHenry, IL (US) 60050

(\*\*) Term: **14 Years**

(21) Appl. No.: **29/135,847**

(22) Filed: **Jan. 18, 2001**

(51) **LOC (7) Cl.** ..... **11-01**

(52) **U.S. Cl.** ..... **D11/26**

(58) **Field of Search** ..... D11/26-39, 1-5;  
63/15, 15.1, 15.2, 15.3, 15.4, 15.45, 15.5,  
15.6, 15.65, 15.7, 15.8, 15.9, 26-29, 3

(56) **References Cited**

**U.S. PATENT DOCUMENTS**

921,759 A	*	5/1909	Walker	.....	63/28
D246,579 S	*	12/1977	Barr	.....	D11/34
D275,089 S	*	8/1984	Bulgari	.....	D11/34
6,065,971 A	*	5/2000	Lennon	.....	63/3
D445,716 S	*	7/2001	Goldstein	.....	D11/26

**OTHER PUBLICATIONS**

Platinum Guild International USA magazine; Platinum Edition VII; p. 11; Ring center of page.\*

Platinum Guild International USA magazine; Platinum Edition VII; p. 42; Ring center of page.\*

Platinum Guild International USA magazine; Platinum Edition VII; p. 46; Ring center of page.\*

Platinum Guild International USA magazine; Platinum Edition VII; p. 109; Ring center of page.\*

Platinum Guild International USA magazine; Platinum Edition VII; p. 123; Ring center right on page.\*

Platinum Guild International USA magazine; Platinum Edition VI; p. 22; Ring center bottom on page.\*

Platinum Guild International USA magazine; Platinum Edition VI; p. 91; Rings center left on page and bottom right corner on page.\*

Platinum Guild International USA magazine; Platinum Edition VI; p. 123; Ring bottom right corner on page.\*

\* cited by examiner

*Primary Examiner*—Cathy Anne MacCormac  
(74) *Attorney, Agent, or Firm*—Eugene F. Friedman

(57) **CLAIM**

What is claimed is the ornamental design for a ring, as shown and described.

**DESCRIPTION**

FIG. 1 is a front perspective view of a ring showing the new design;

FIG. 2 is a front elevational view thereof;

FIG. 3 is a right side elevational view thereof the left side being identical;

FIG. 4 is a top plan view thereof the bottom being identical;

FIG. 5 is a rear elevational view thereof;

FIG. 6 is a front perspective view of second embodiment of FIG. 1;

FIG. 7 is a front elevational view of FIG. 6;

FIG. 8 is a right side elevational view of FIG. 6 the left side being identical;

FIG. 9 is a top plan view of FIG. 6 the bottom being identical;

FIG. 10 is a rear elevational view of FIG. 6;

FIG. 11 is a front perspective view of a third embodiment of FIG. 1;

FIG. 12 is a front elevational view of FIG. 11;

FIG. 13 is a right side elevational view of FIG. 11 the left side being identical;

FIG. 14 is a top plan view of FIG. 11 the bottom being identical;

FIG. 15 is a rear elevational view of FIG. 11;

FIG. 16 is a front perspective view of a fourth embodiment of FIG. 1;

FIG. 17 is a front elevational view of FIG. 16;

FIG. 18 is a right side elevational view of FIG. 16 the left side being identical;

FIG. 19 is a top plan view of FIG. 16 the bottom being identical;

FIG. 20 is a rear elevational view of FIG. 16;

FIG. 21 is a front perspective view of a fifth embodiment of FIG. 1 identical;

FIG. 22 is a front elevational view of FIG. 21;

FIG. 23 is a right side elevational view of FIG. 21 the left side being identical;

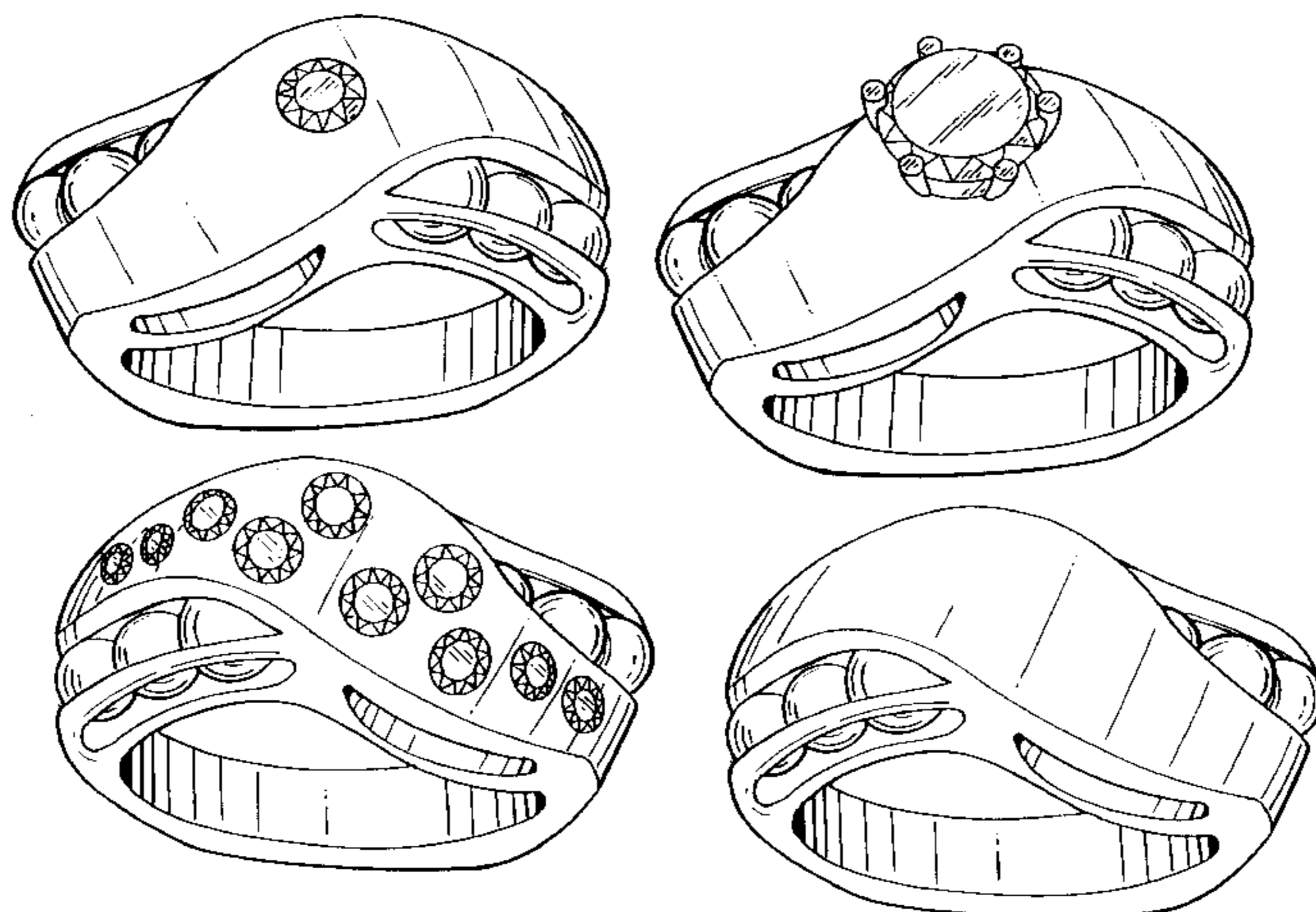

FIG. 24 is a top plan view of FIG. 21 the bottom being identical;  
FIG. 25 is a rear elevational view of FIG. 21;  
FIG. 26 is a front perspective view of a sixth embodiment of FIG. 1;  
FIG. 27 is a front elevational view of FIG. 26;  
FIG. 28 is a right side elevational view of FIG. 26 the left side being identical;  
FIG. 29 is a top plan view of FIG. 26 the bottom being identical;  
FIG. 30 is a rear elevational view of FIG. 26;  
FIG. 31 is a front perspective view of a seventh embodiment of FIG. 1;  
FIG. 32 is a front elevational view of FIG. 31;  
FIG. 33 is a right side elevational view of FIG. 31 the left side being identical;  
FIG. 34 is a top plan view of FIG. 31 the bottom being identical;  
FIG. 35 is a rear elevational view of FIG. 31;  
FIG. 36 is a front perspective view of an eighth embodiment of FIG. 1;  
FIG. 37 is a front elevational view of FIG. 36;  
FIG. 38 is a right side elevational view of FIG. 36 the the left side being identical;

FIG. 39 is a top plan view of FIG. 36 the bottom being identical;  
FIG. 40 is a rear elevational view of FIG. 36;  
FIG. 41 is a perspective front view of a ninth embodiment of FIG. 1;  
FIG. 42 is a front elevational view of FIG. 41;  
FIG. 43 is a right side elevational view of FIG. 41 the left side being identical;  
FIG. 44 is a top plan view of FIG. 41 the bottom being identical;  
FIG. 45 is a rear elevational view of FIG. 41;  
FIG. 46 is a front perspective view of a tenth embodiment of FIG. 1;  
FIG. 47 is a front elevational view of FIG. 46;  
FIG. 48 is a right side elevational view of FIG. 46 the left side being identical;  
FIG. 49 is a top plan view of FIG. 46 the bottom being identical; and,  
FIG. 50 is a rear elevational view of FIG. 46.

**1 Claim, 10 Drawing Sheets**

FIG. 1

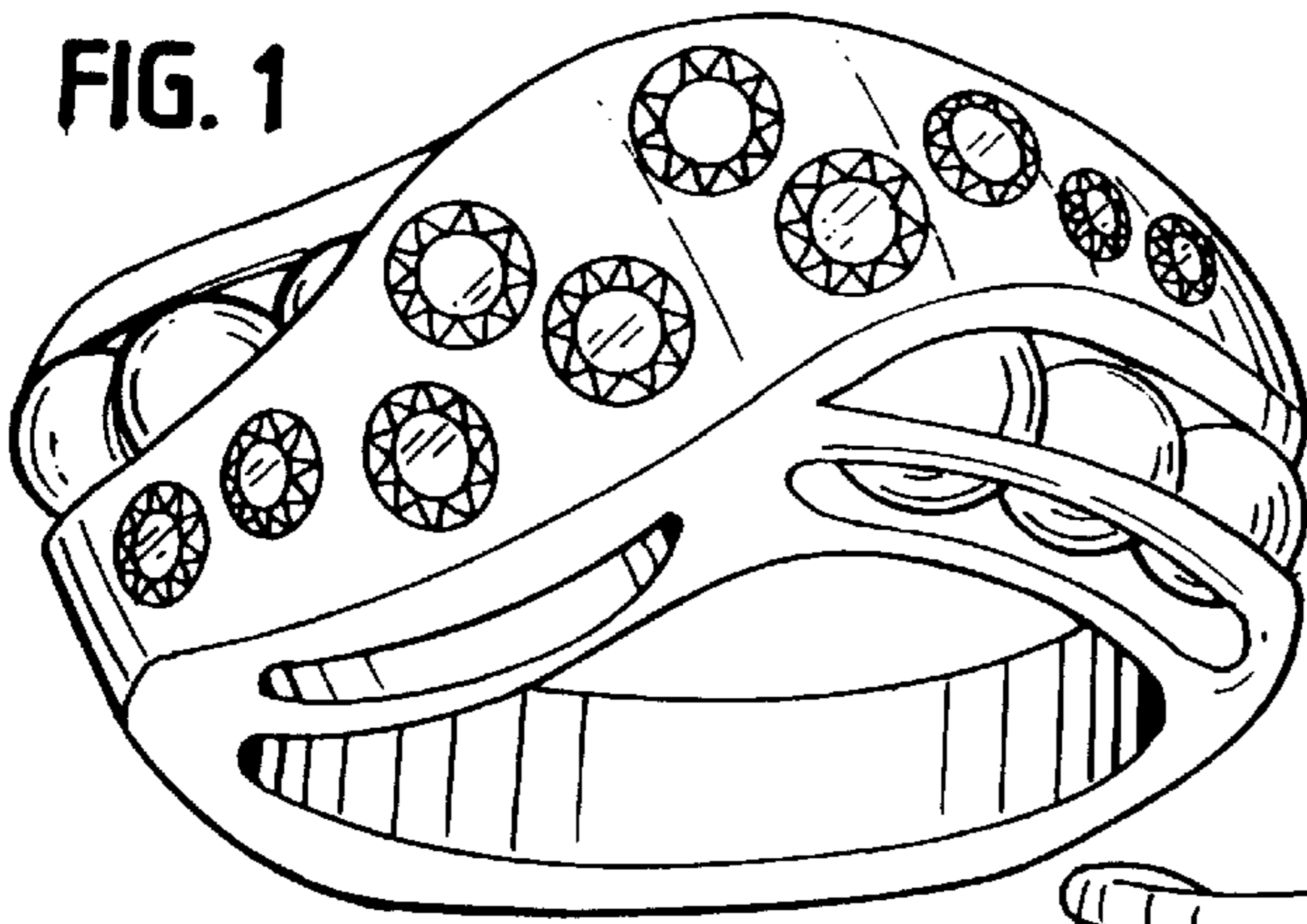

FIG. 2

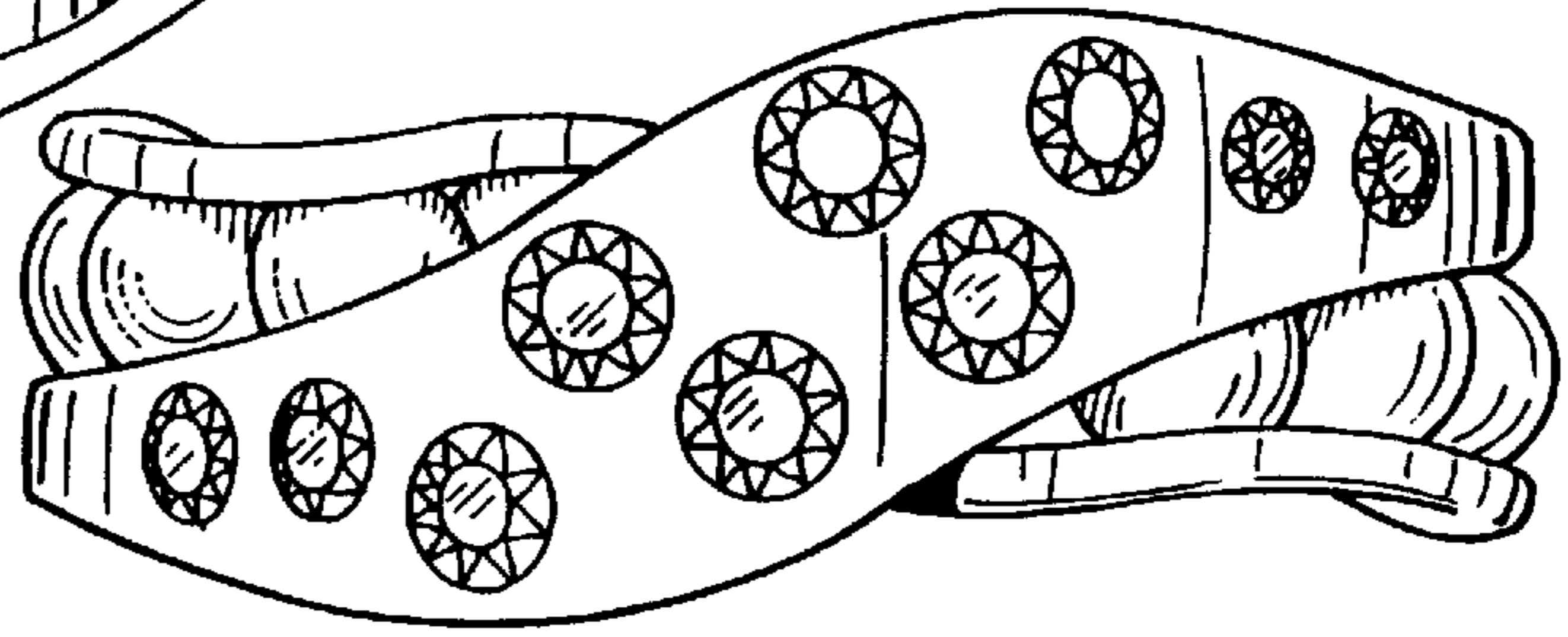

FIG. 3

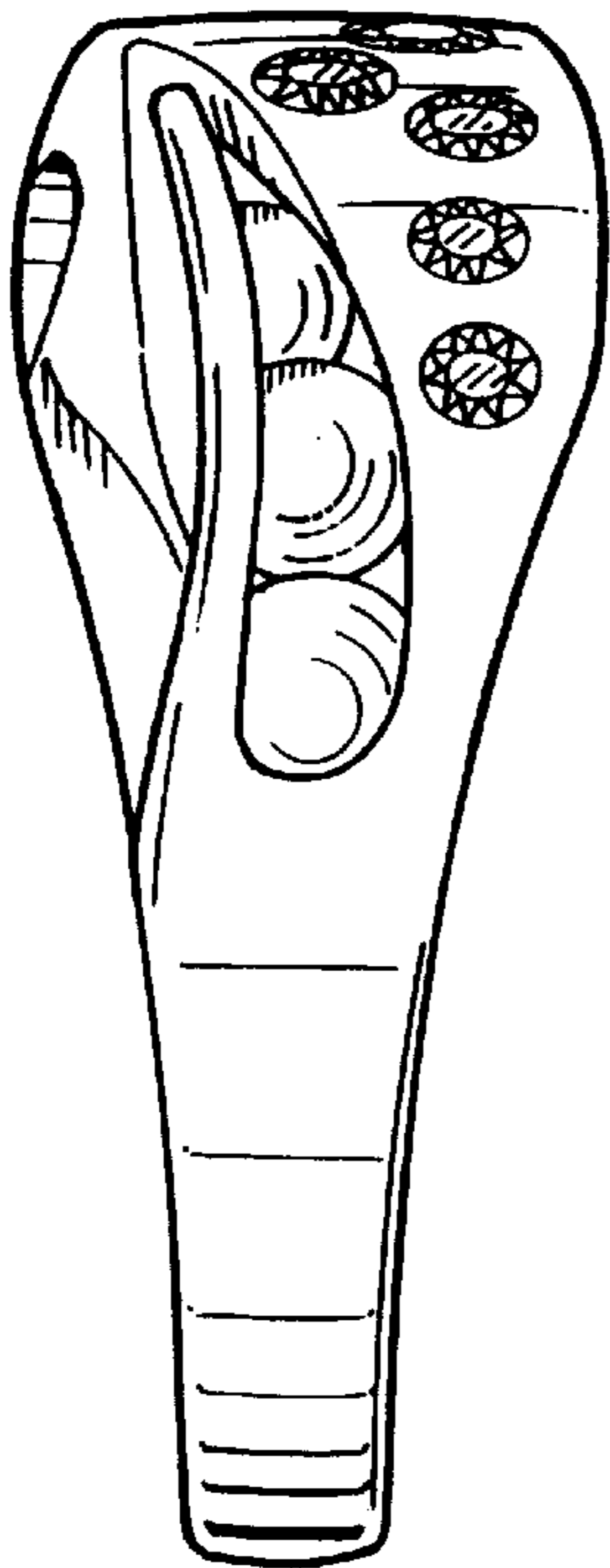

FIG. 4

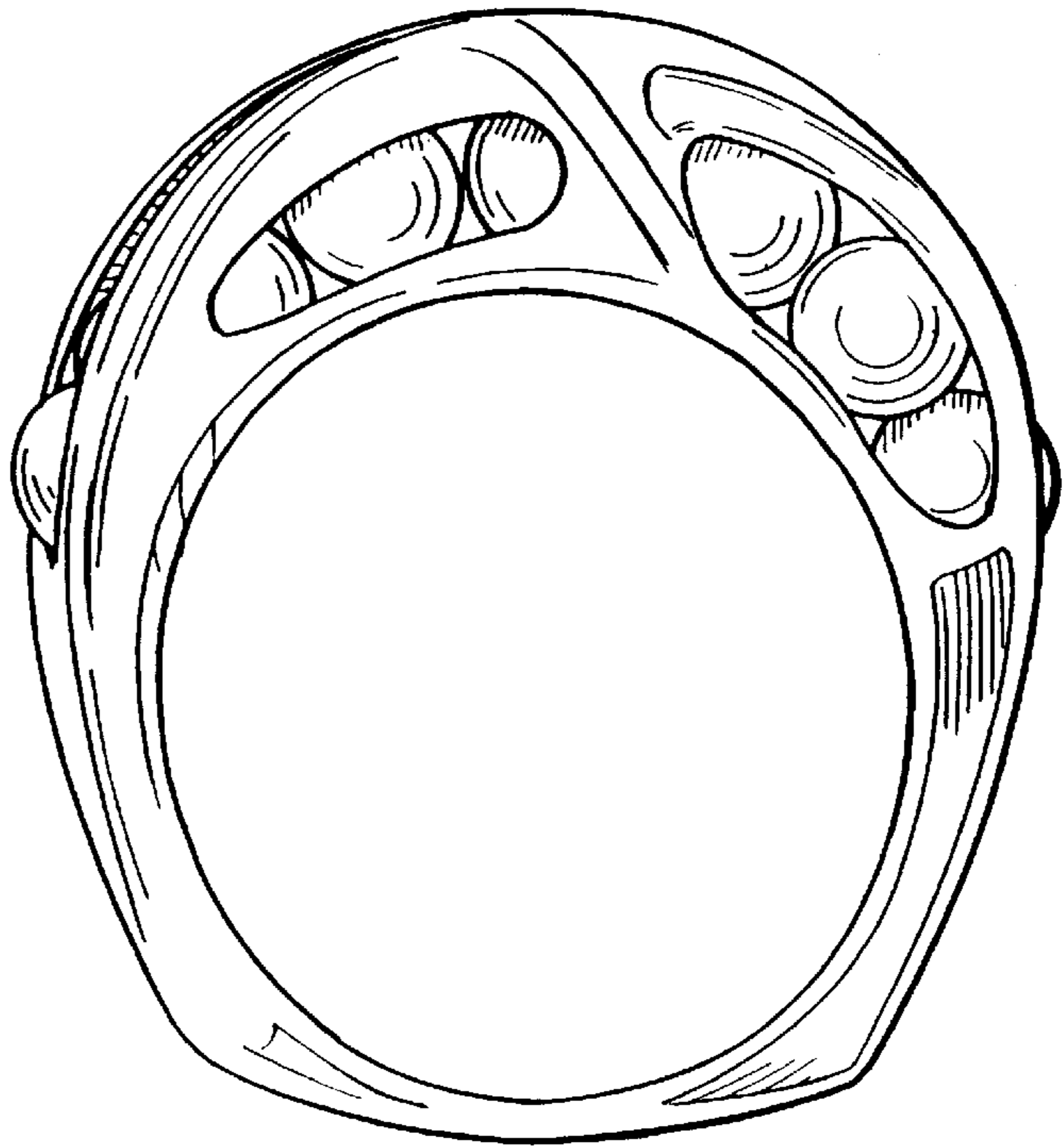

FIG. 5

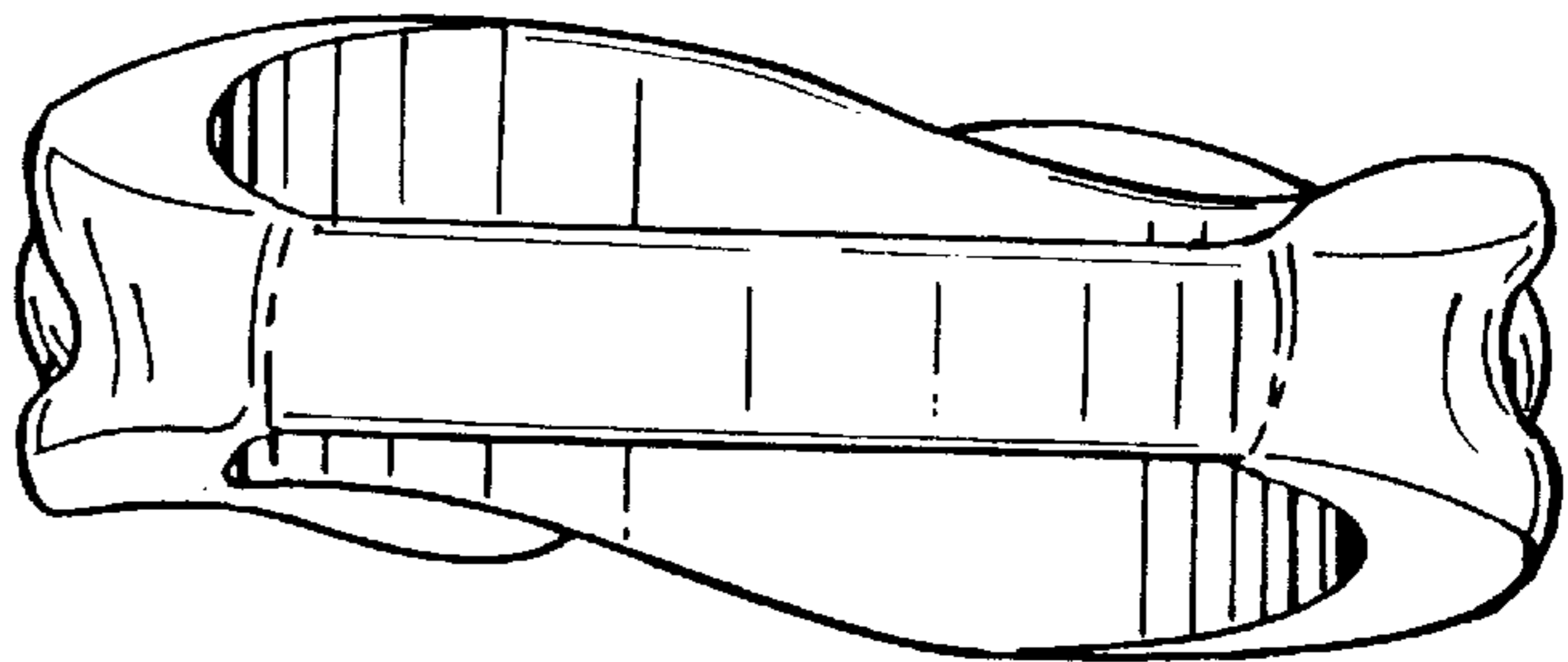

FIG. 6

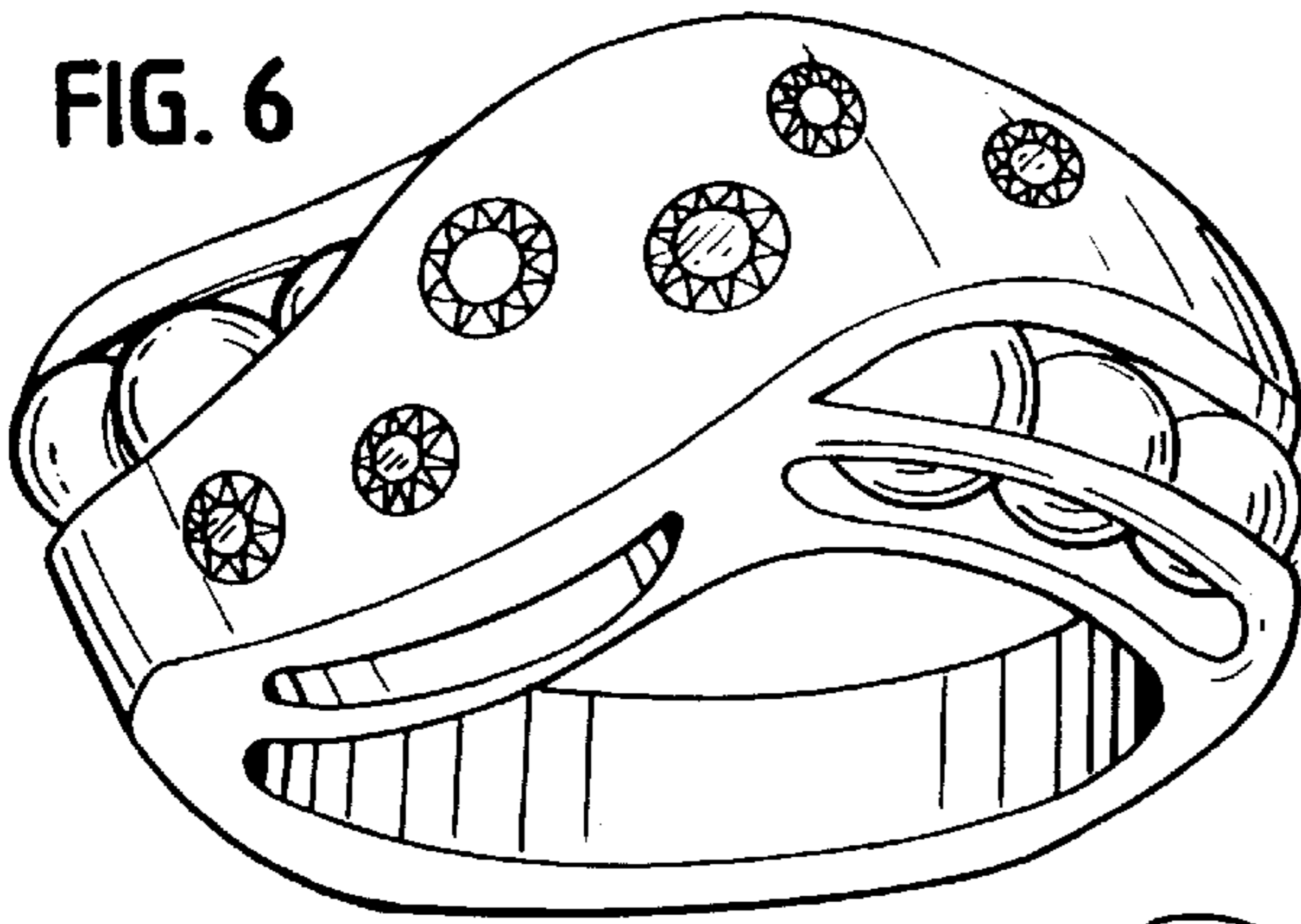

FIG. 7

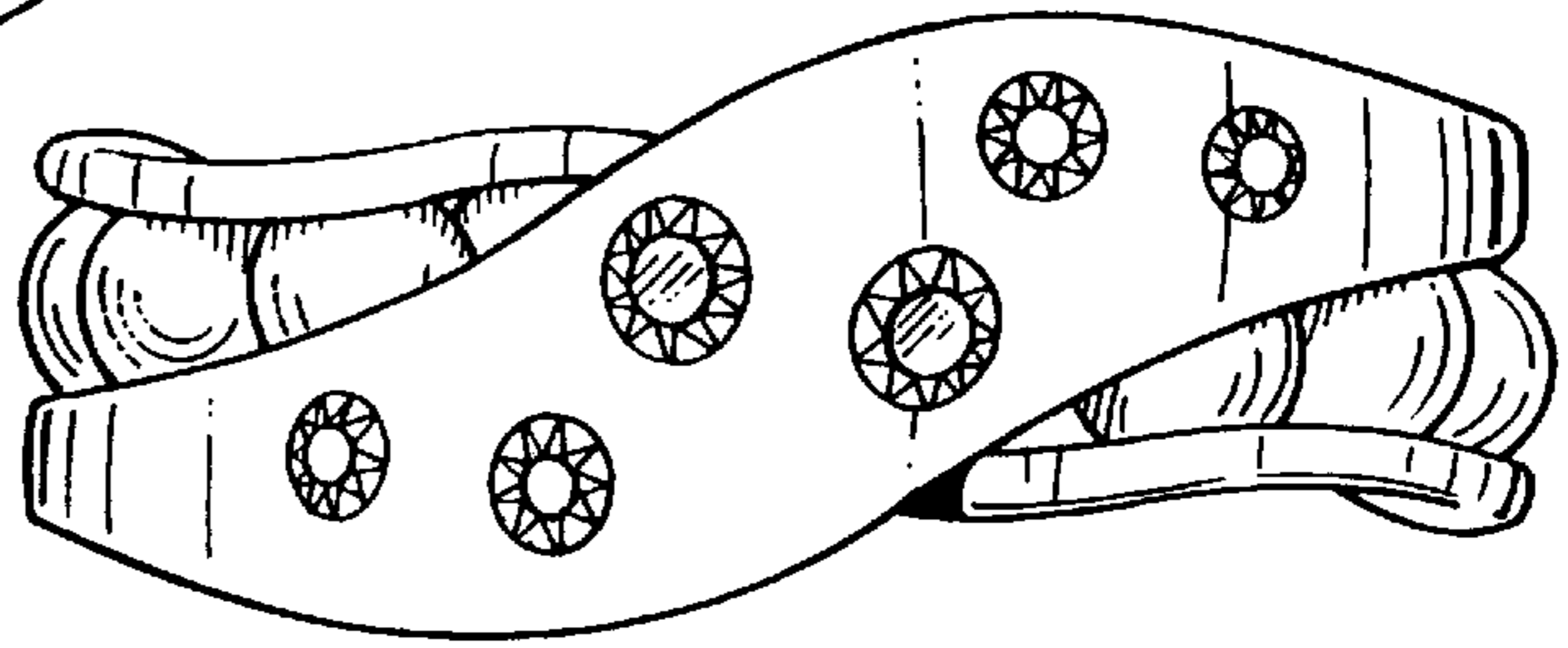

FIG. 8

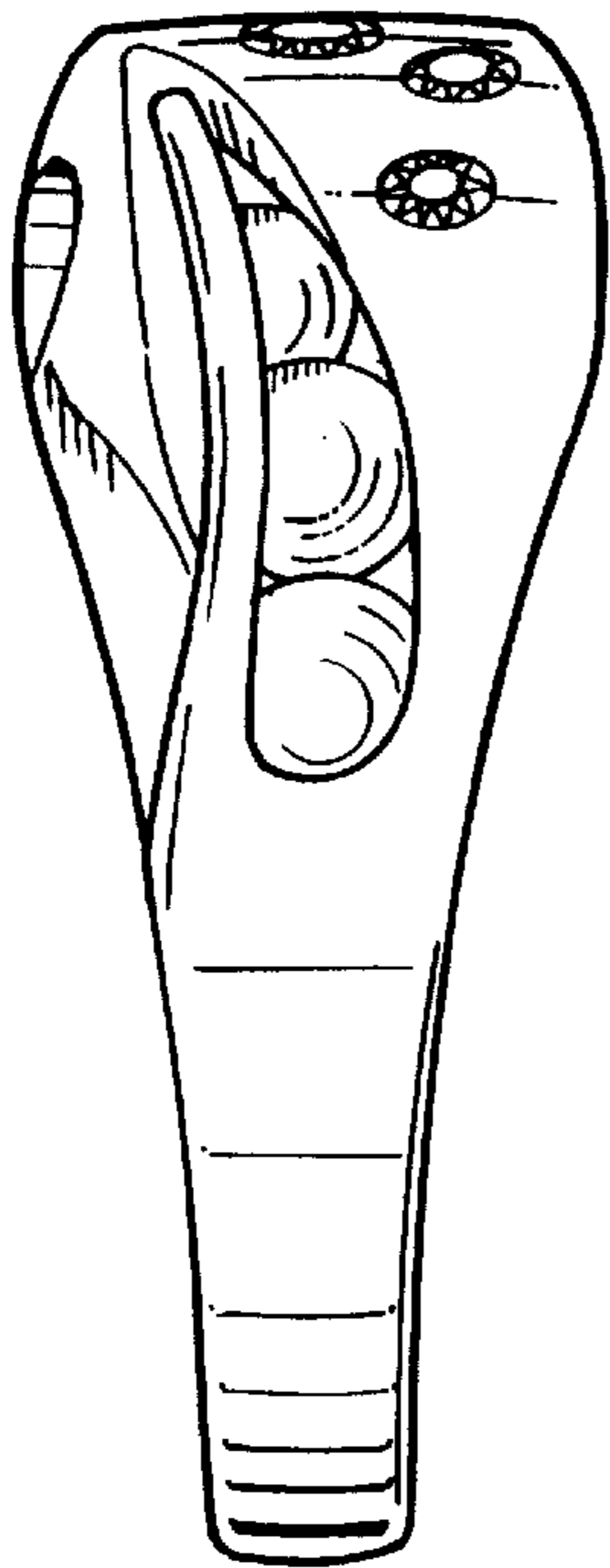

FIG. 9

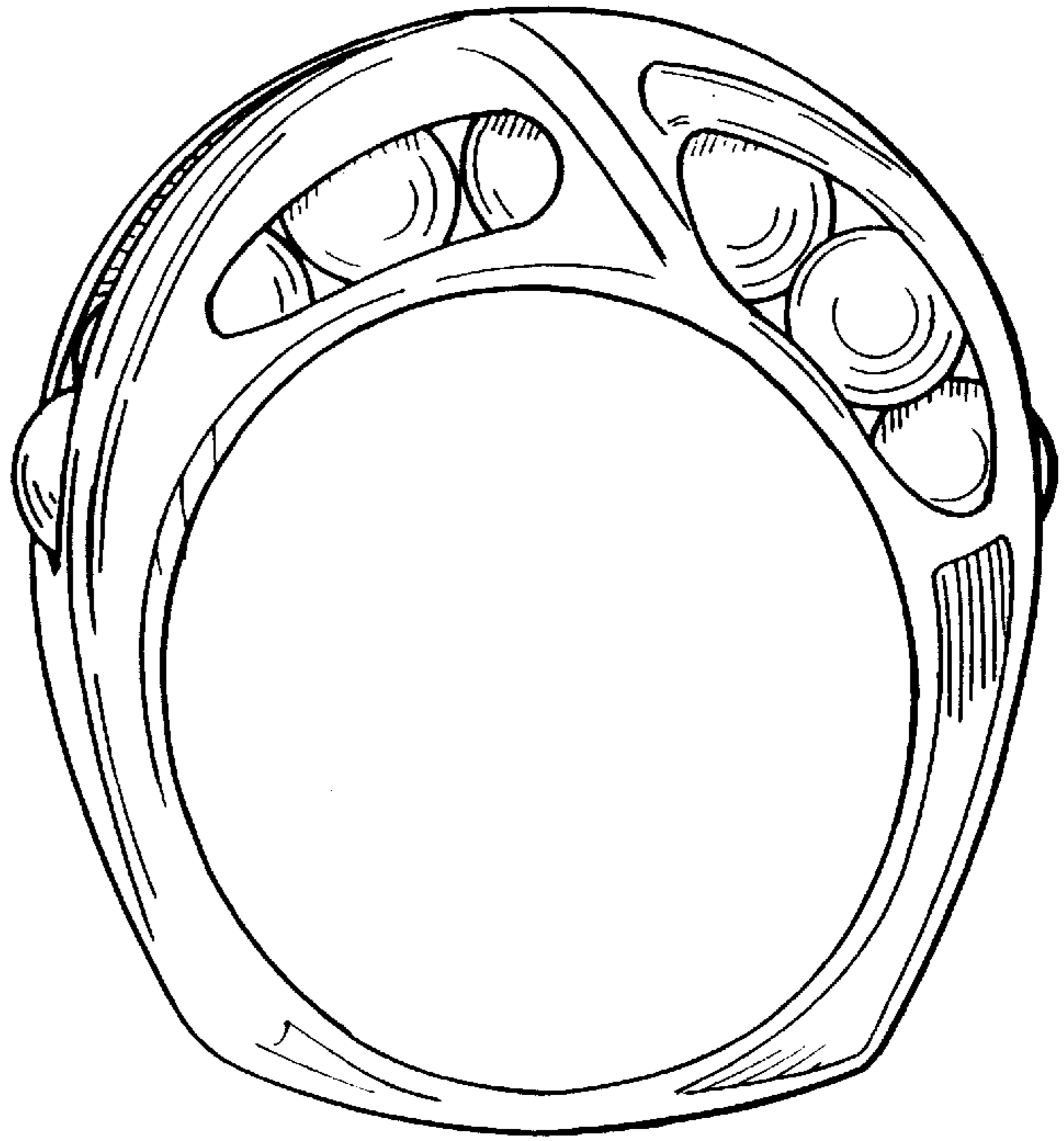

FIG. 10

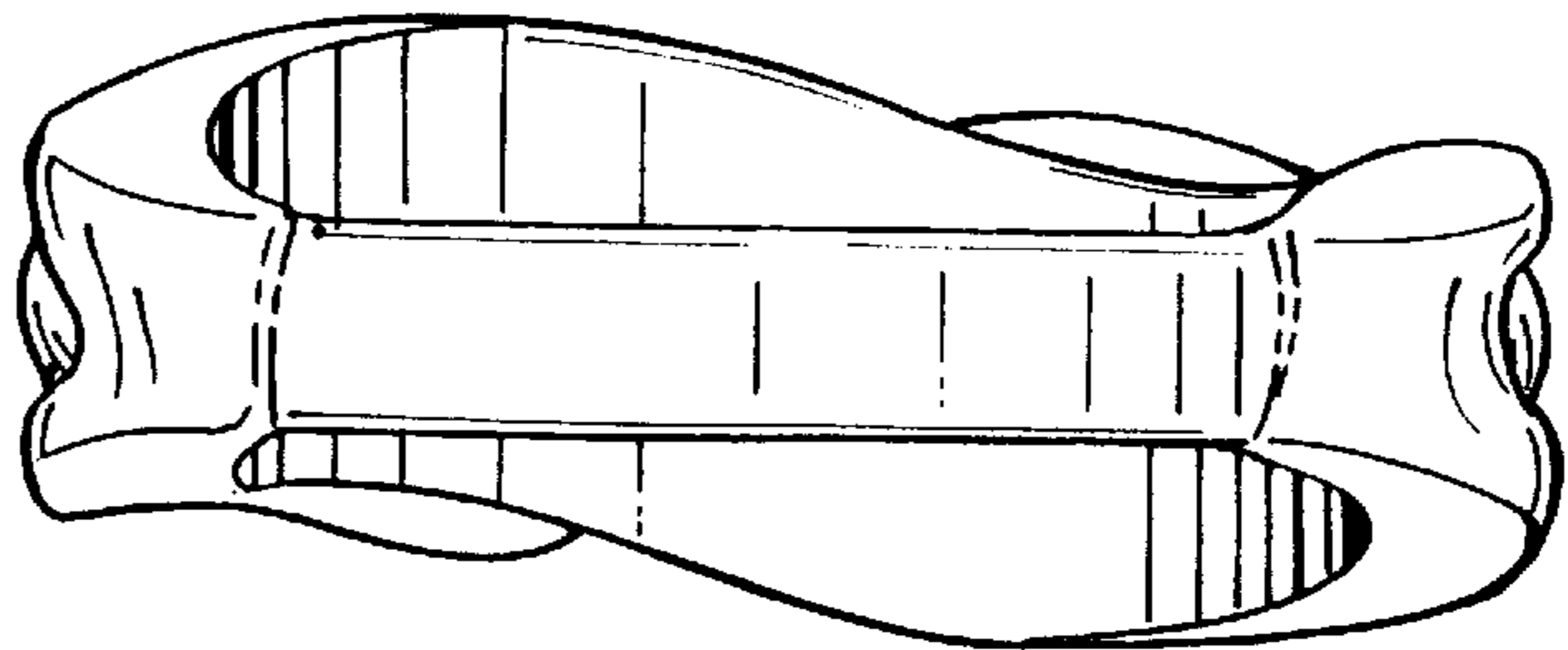

FIG. 11

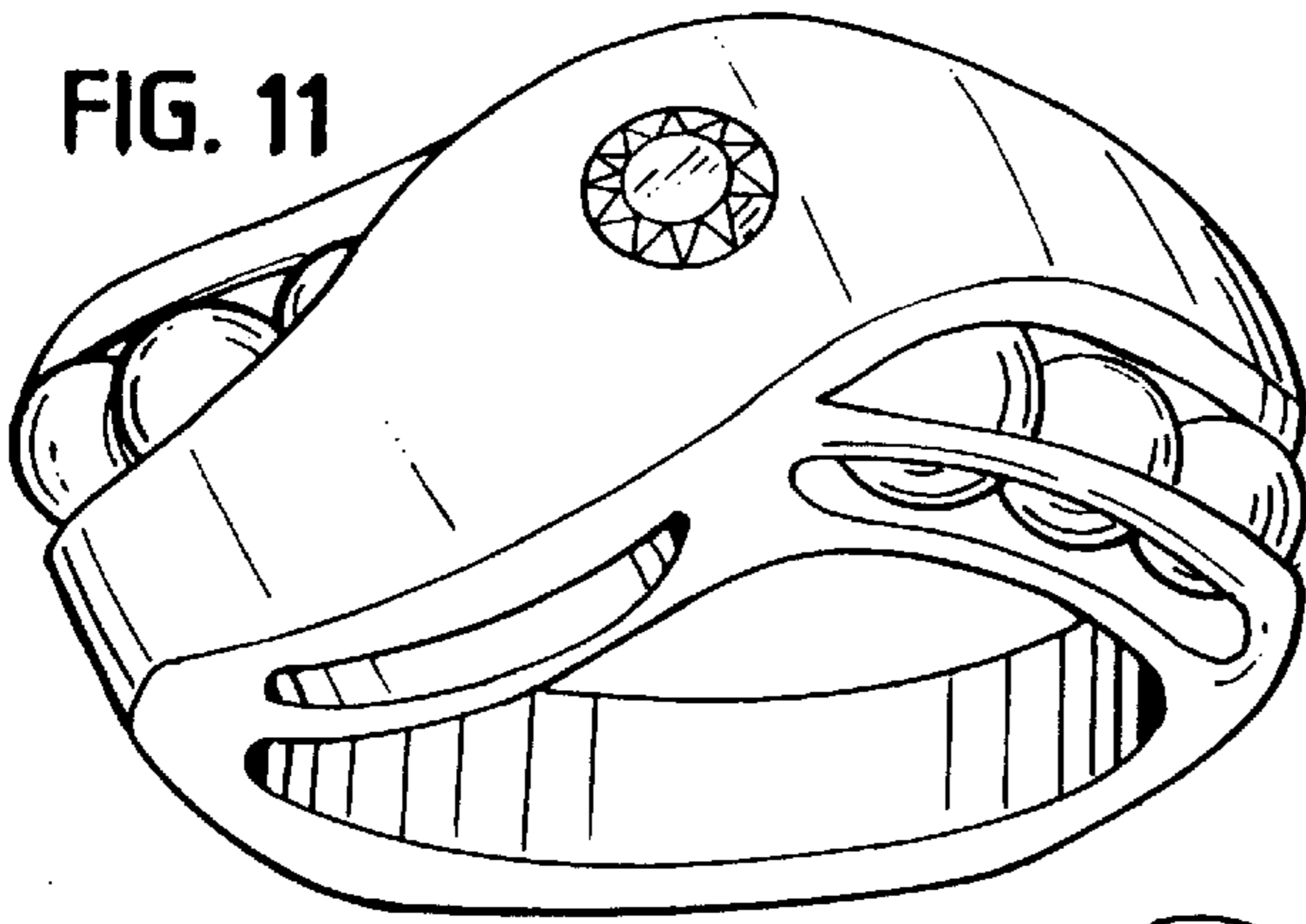

FIG. 12

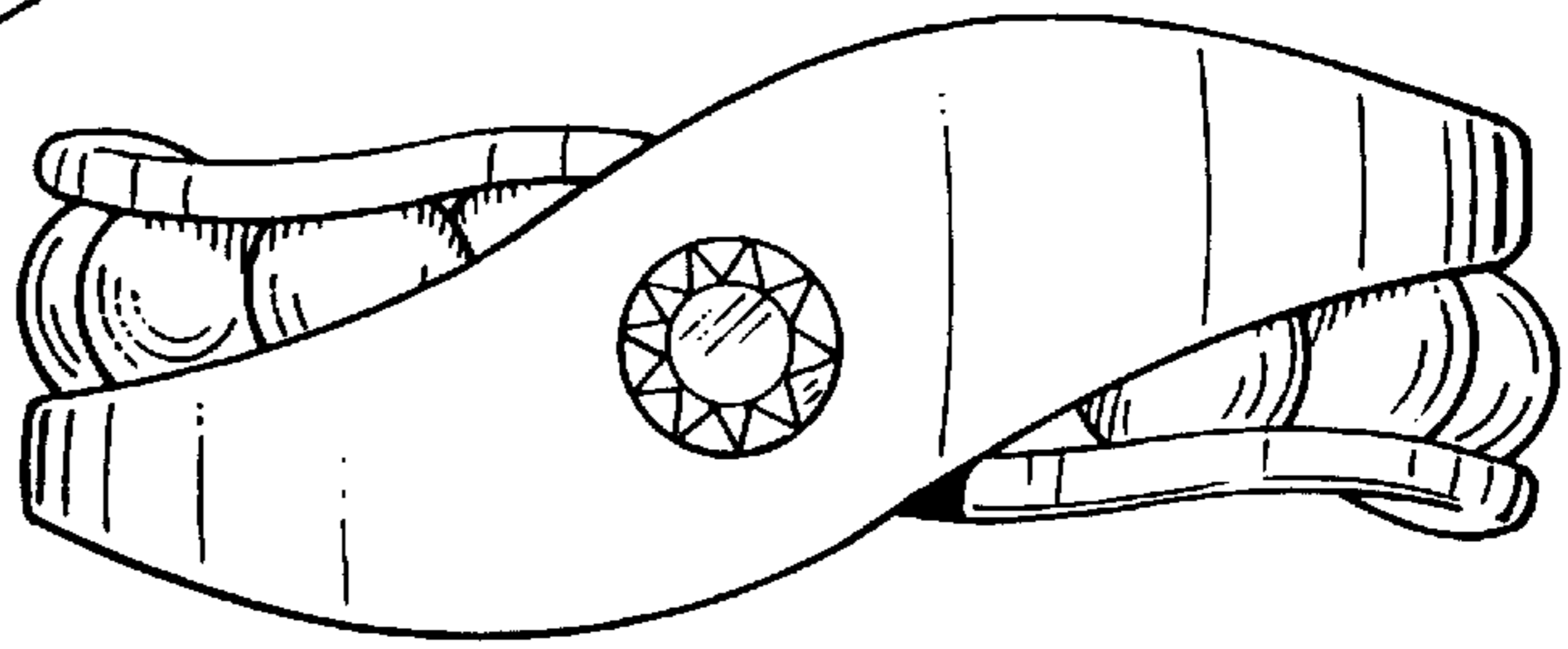

FIG. 13

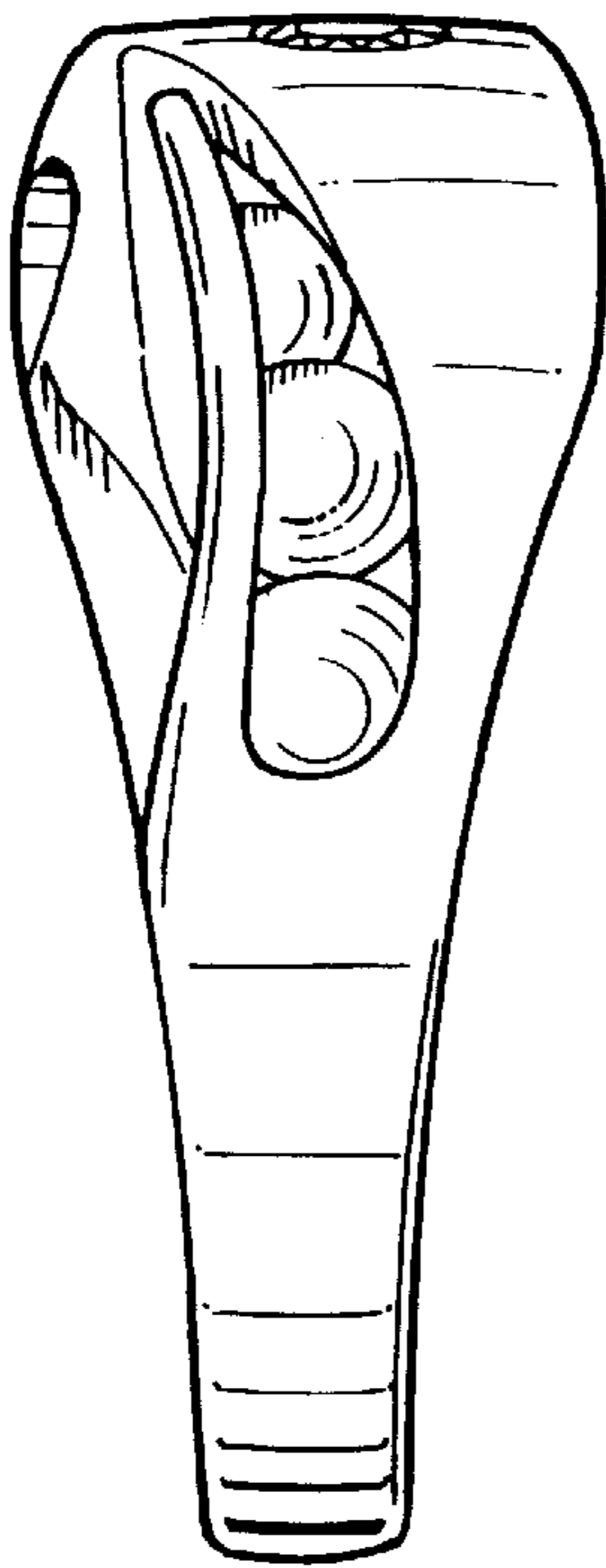

FIG. 14

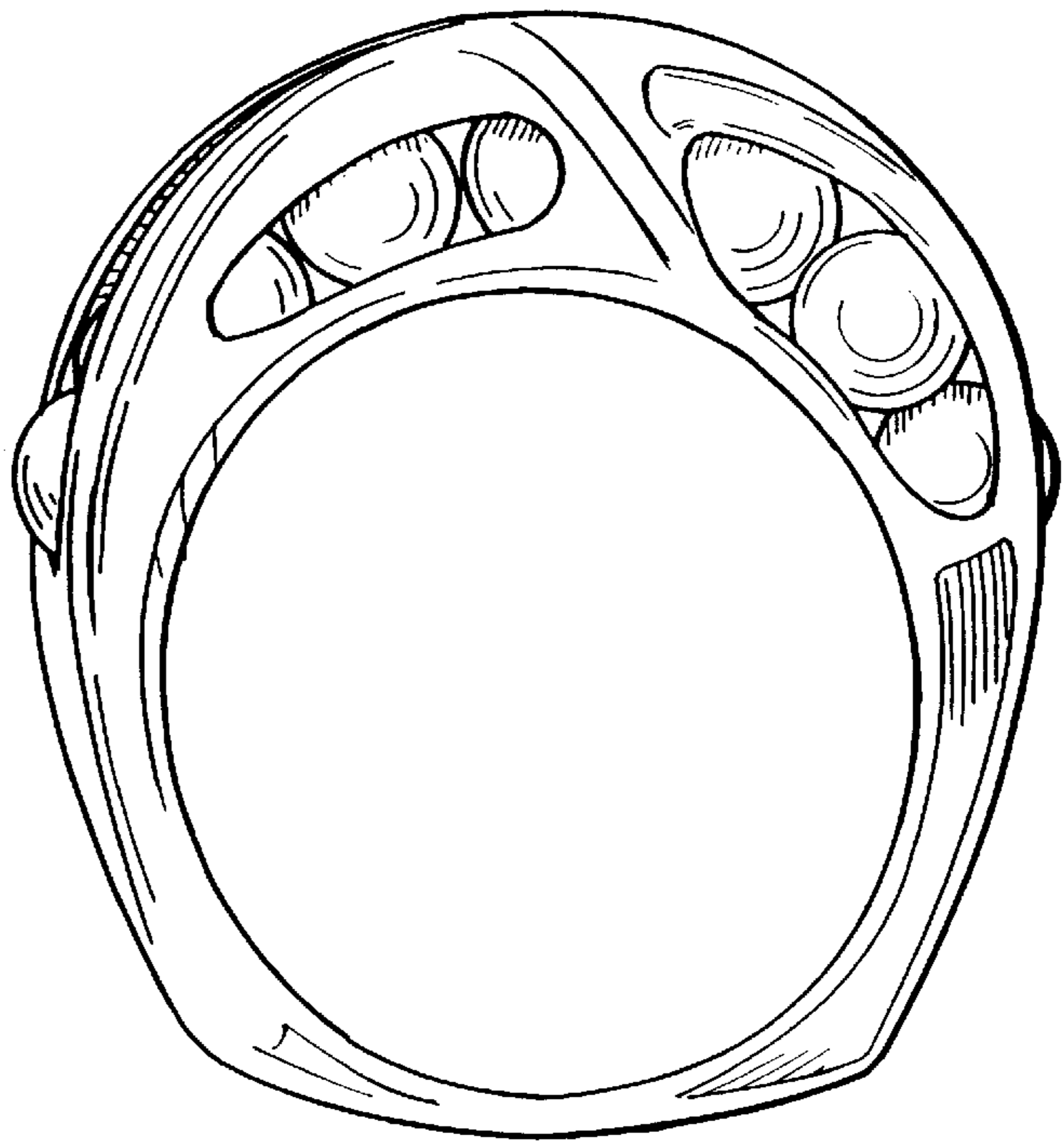

FIG. 15

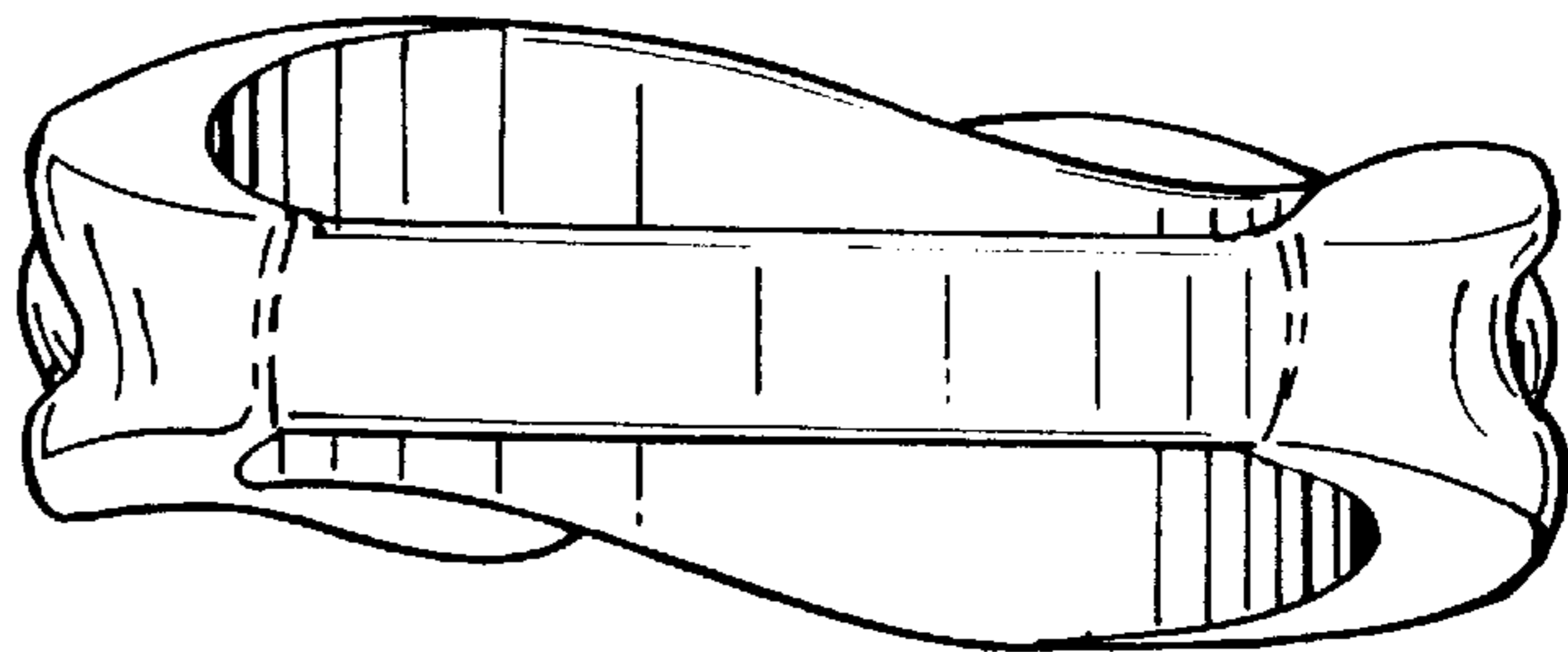

FIG. 16

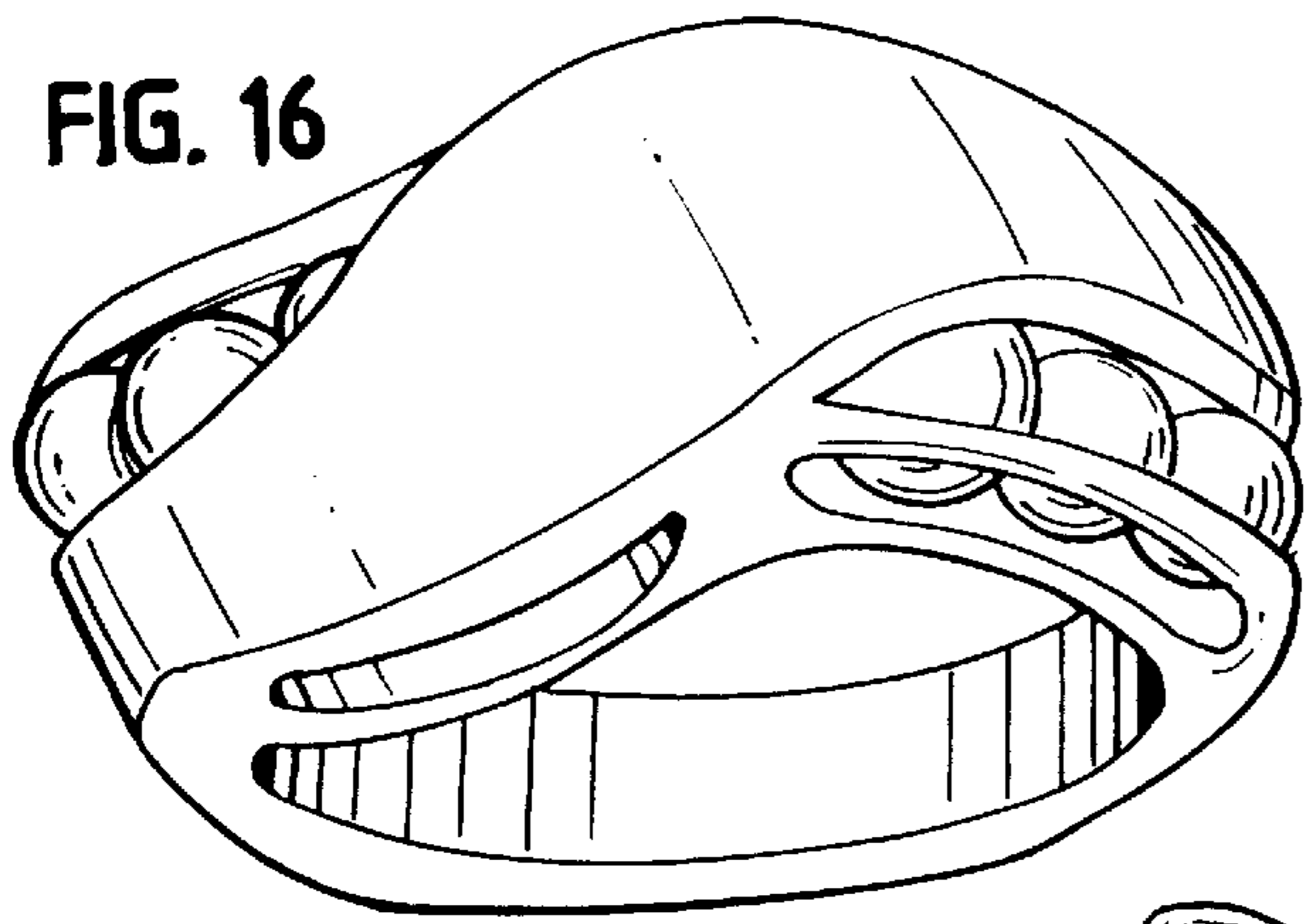

FIG. 17

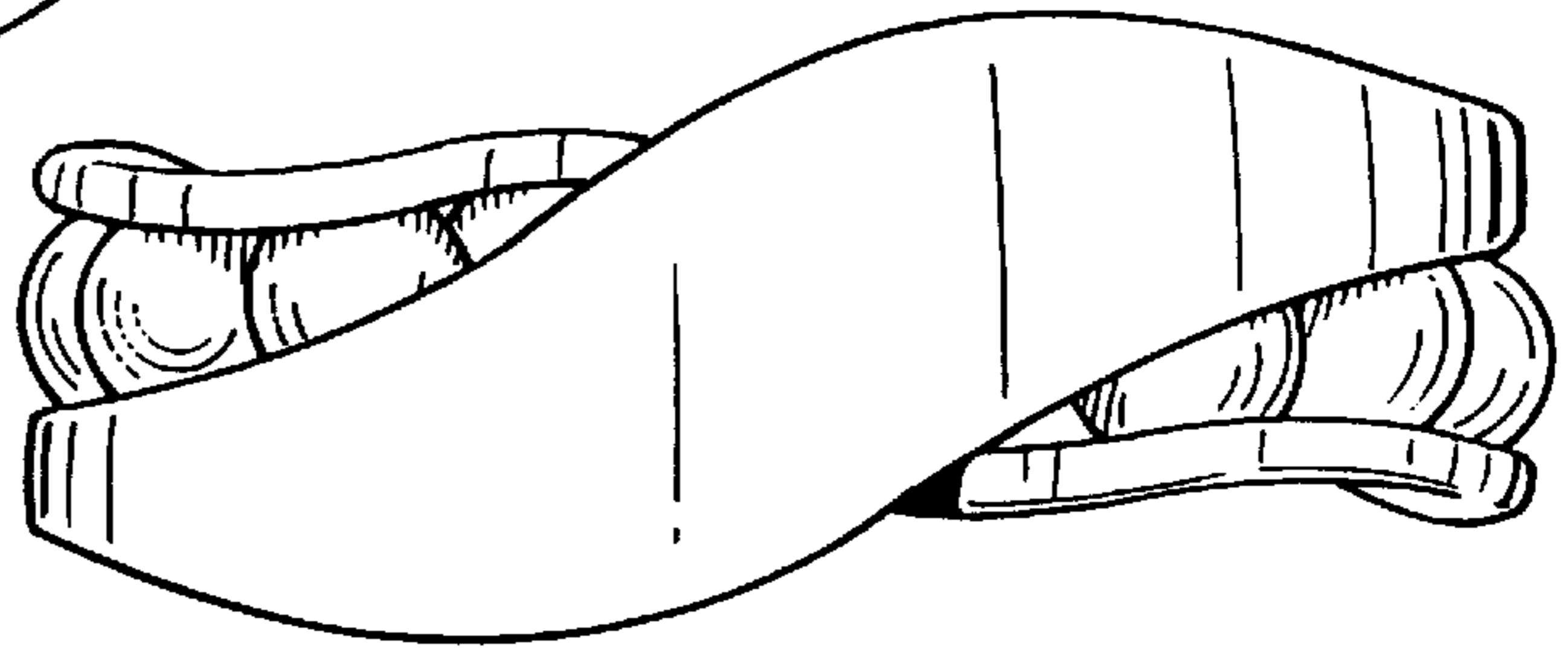

FIG. 18

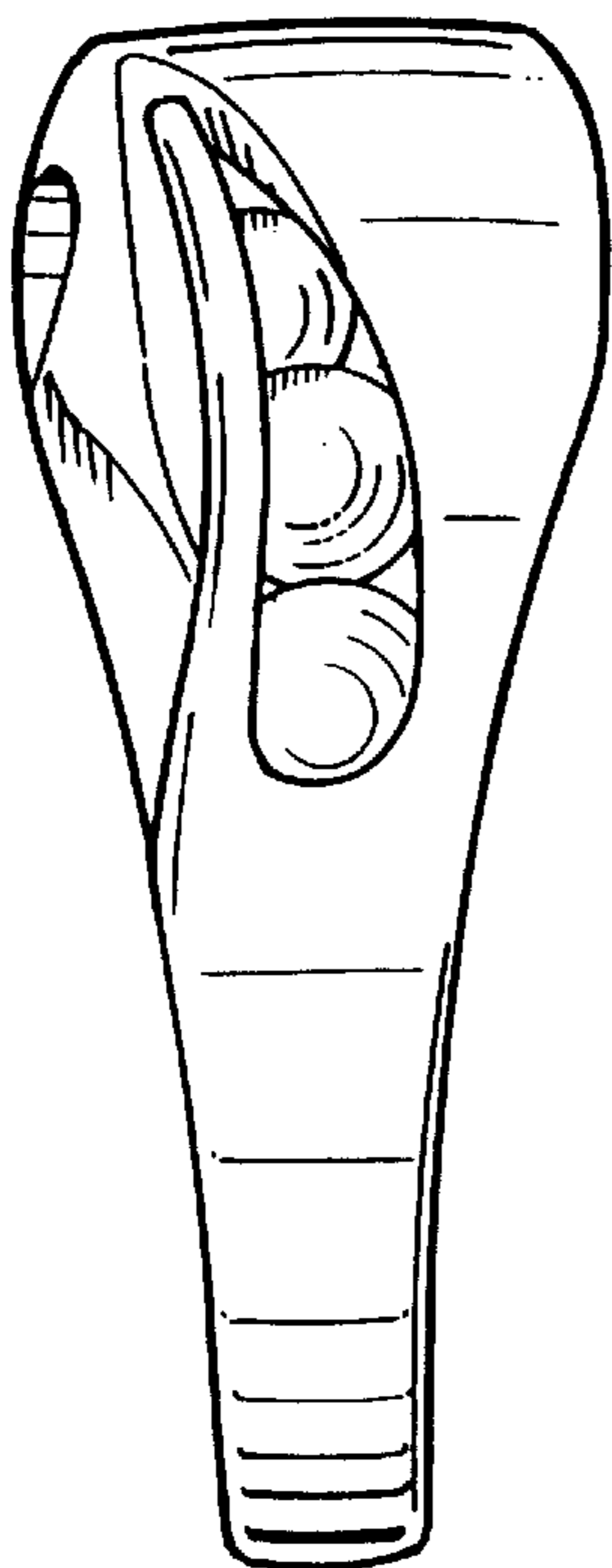

FIG. 19

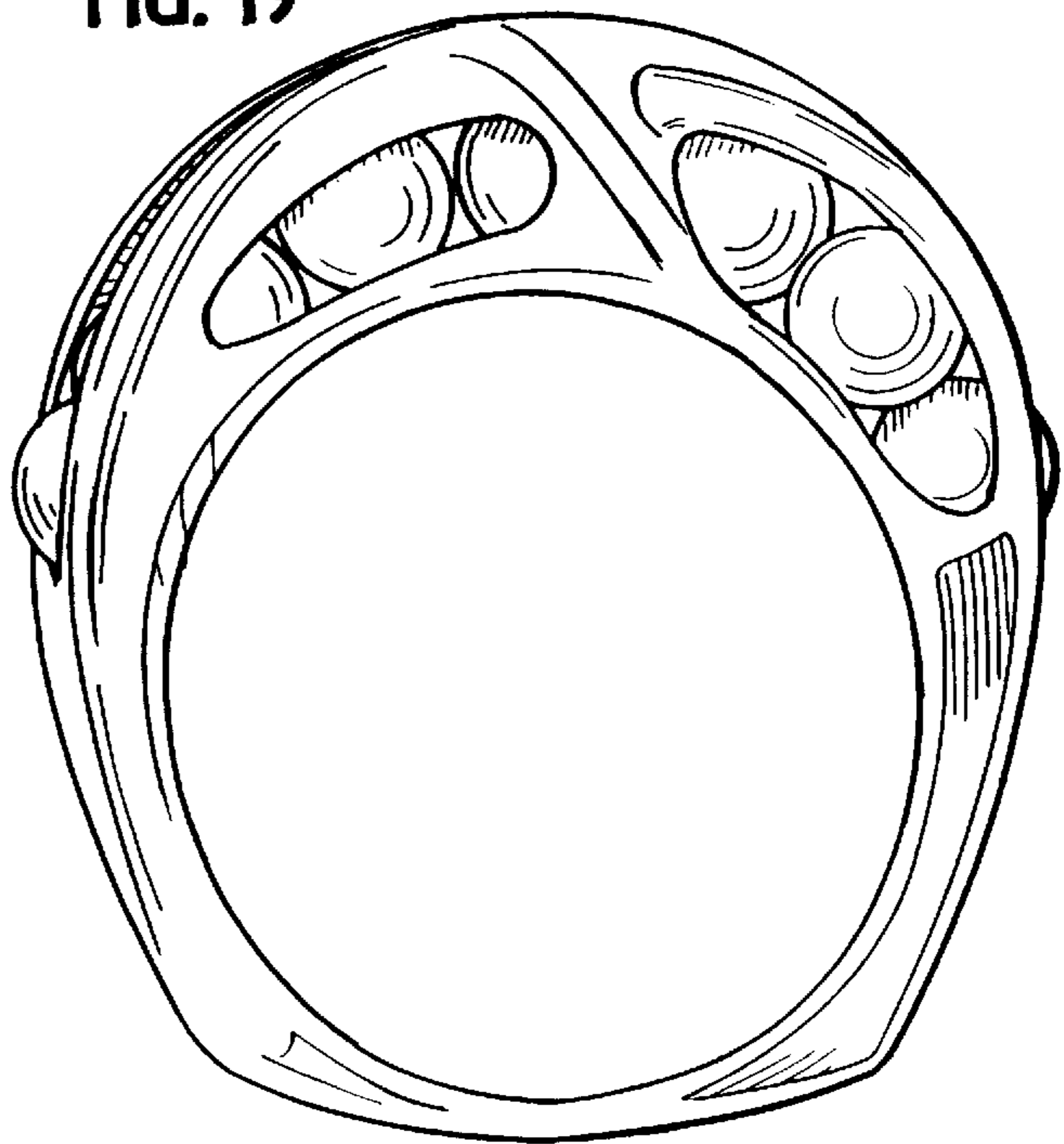
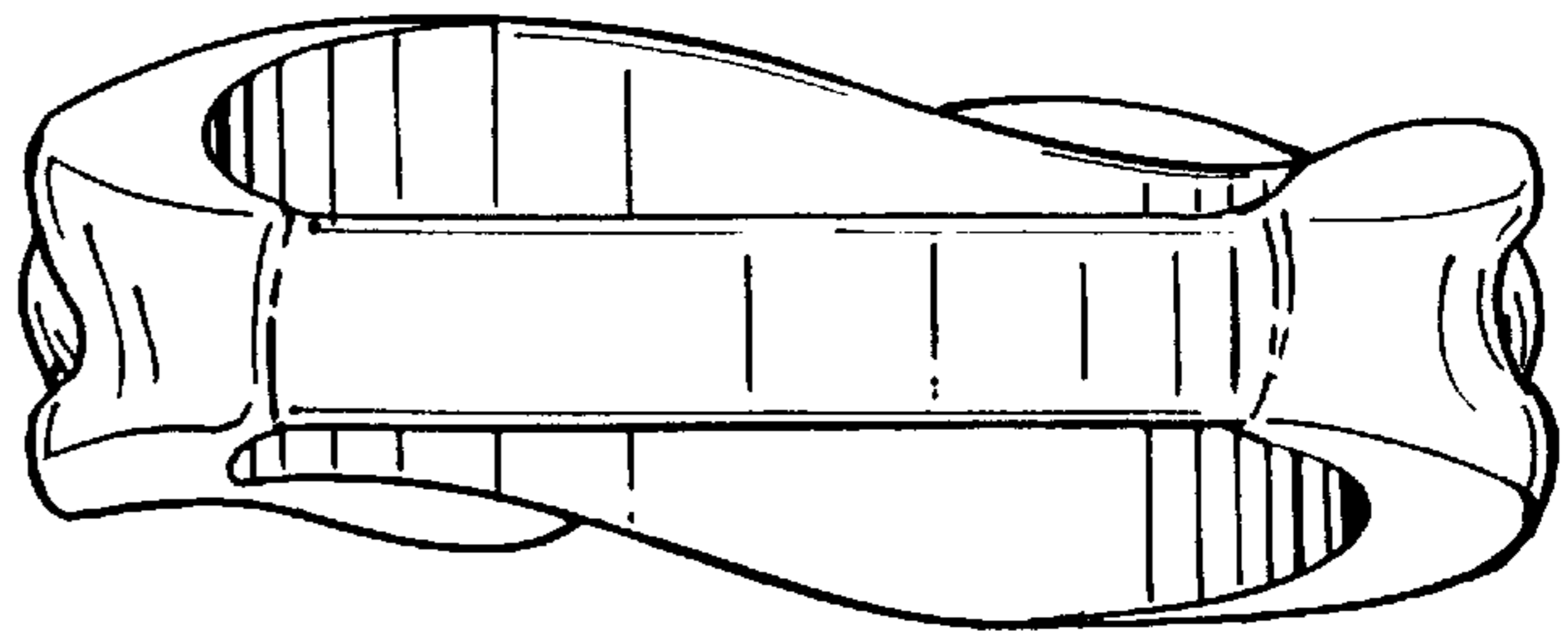
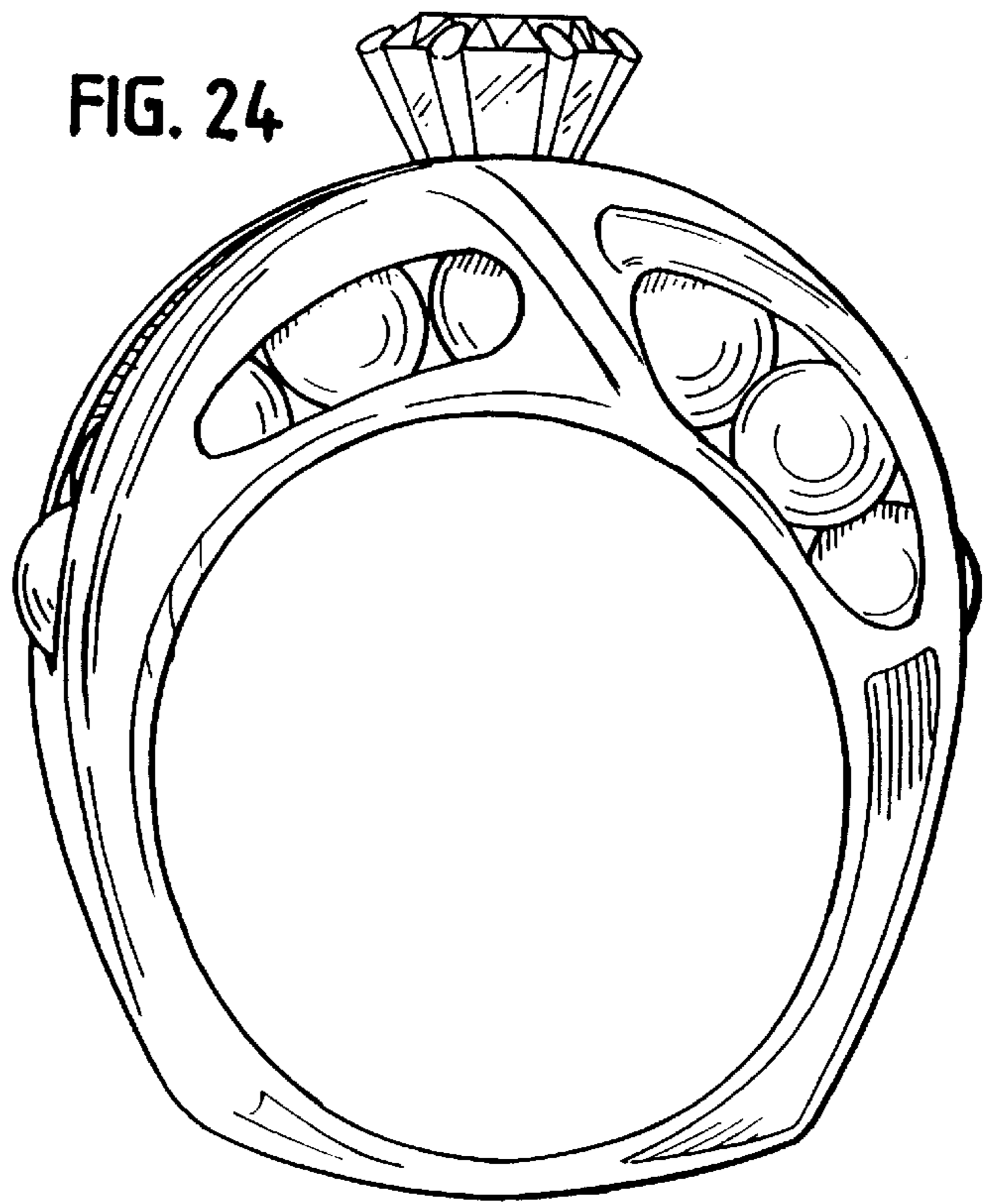
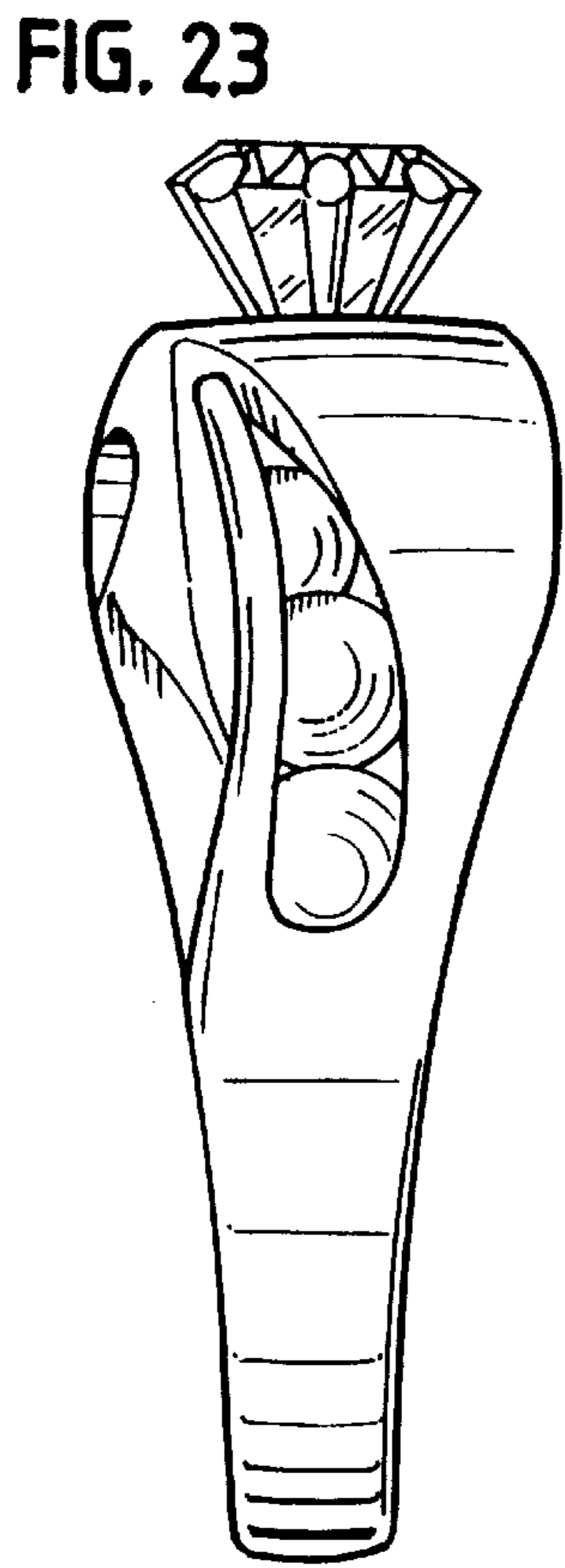
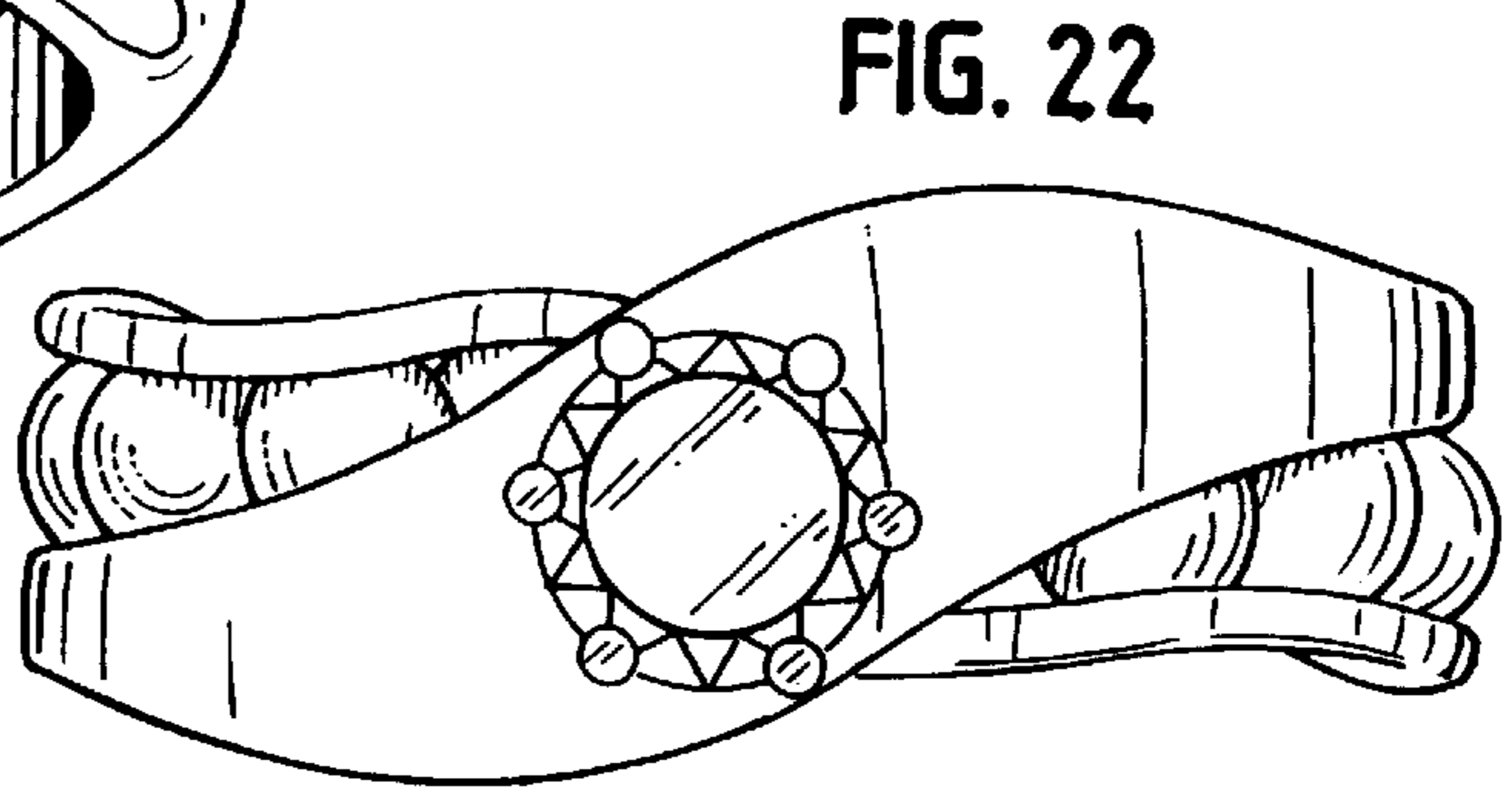
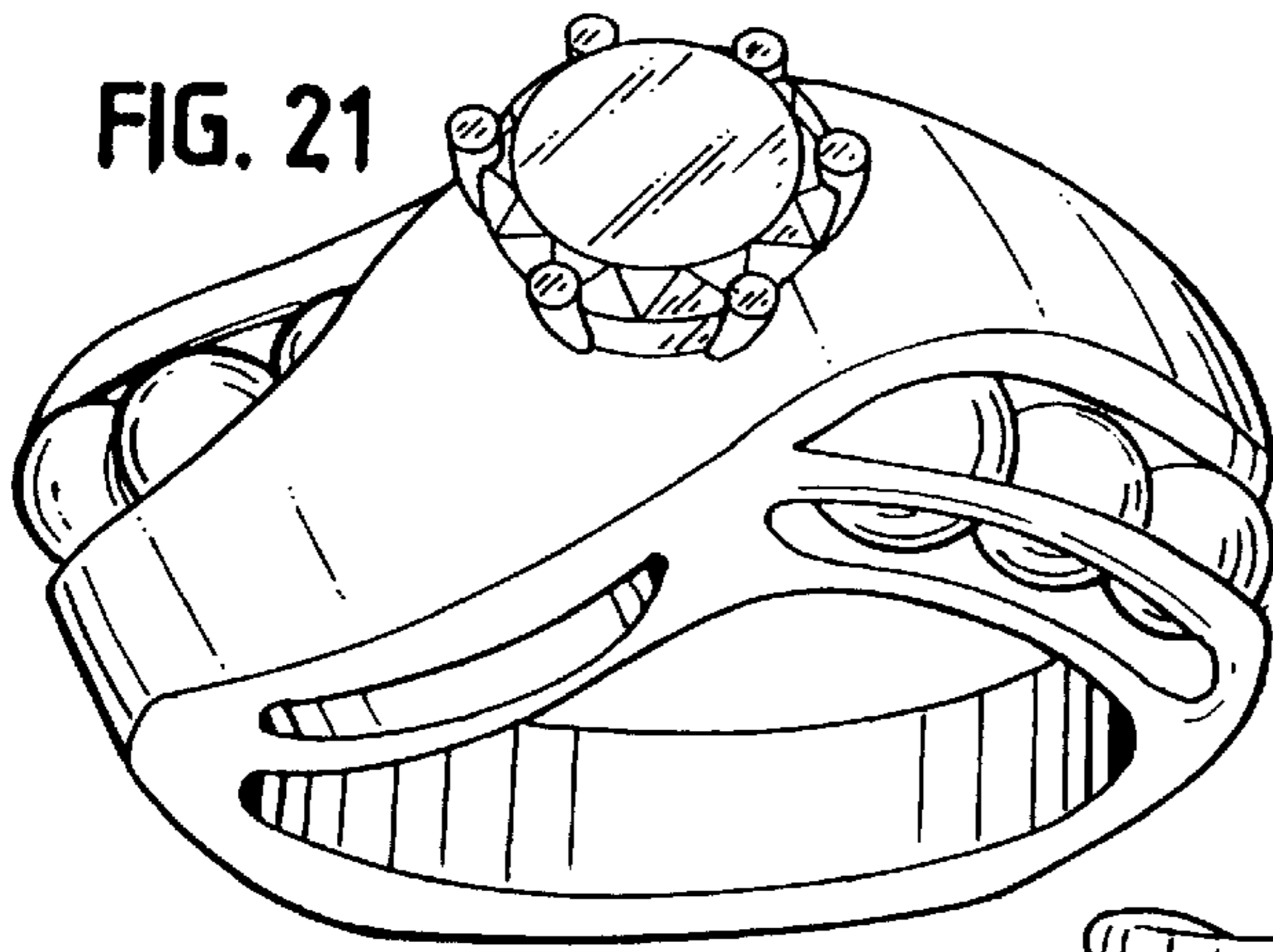

FIG. 20





**FIG. 25**

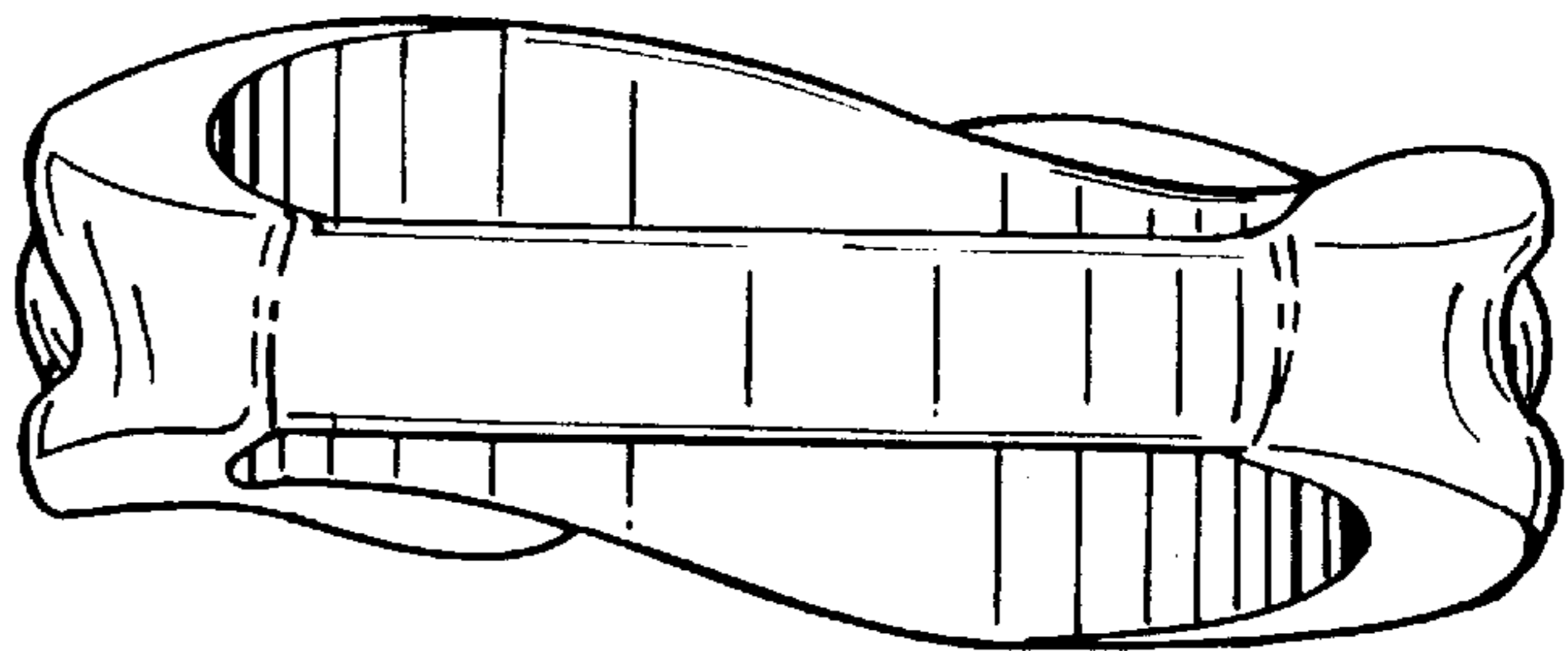

FIG. 26

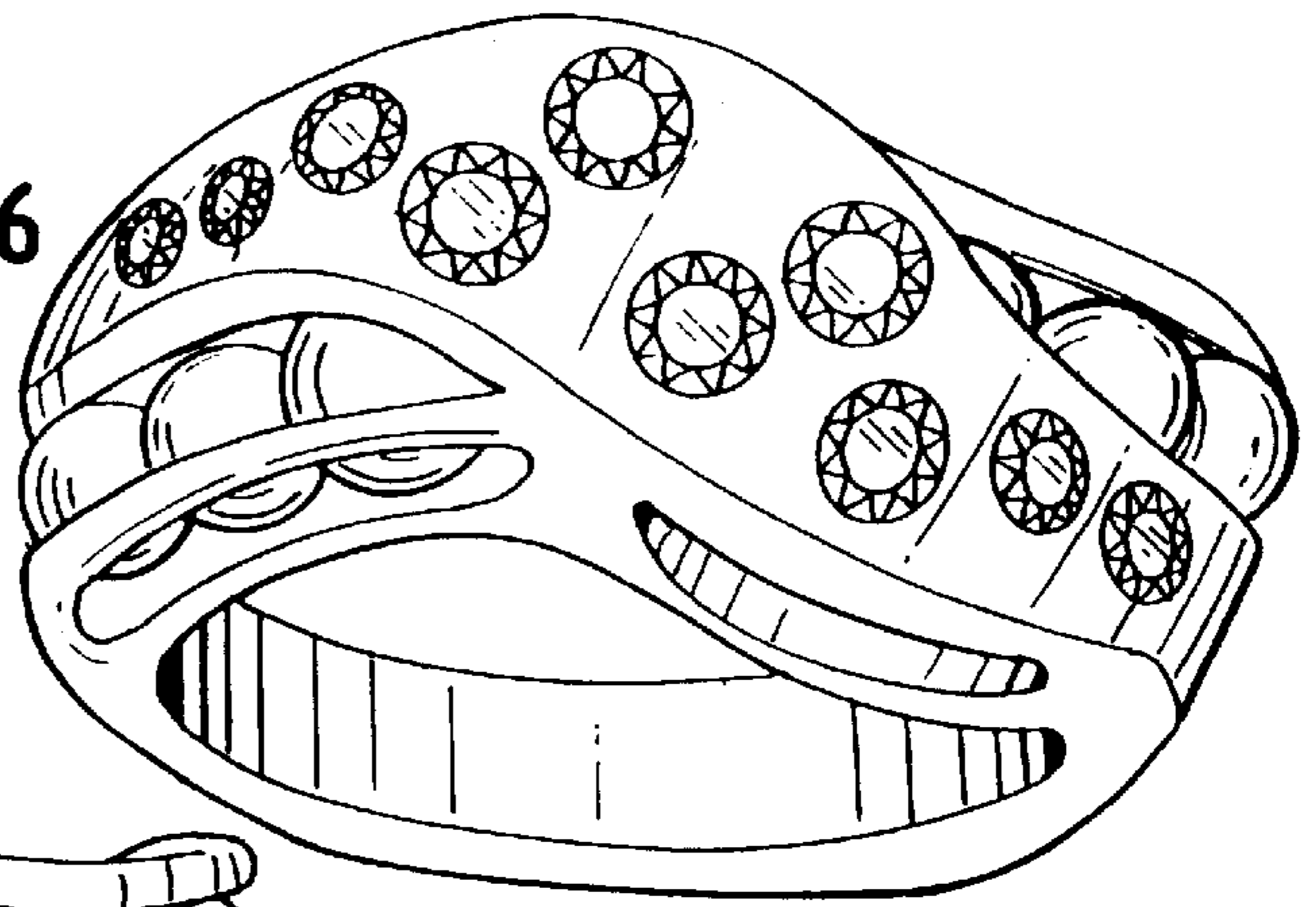

FIG. 27

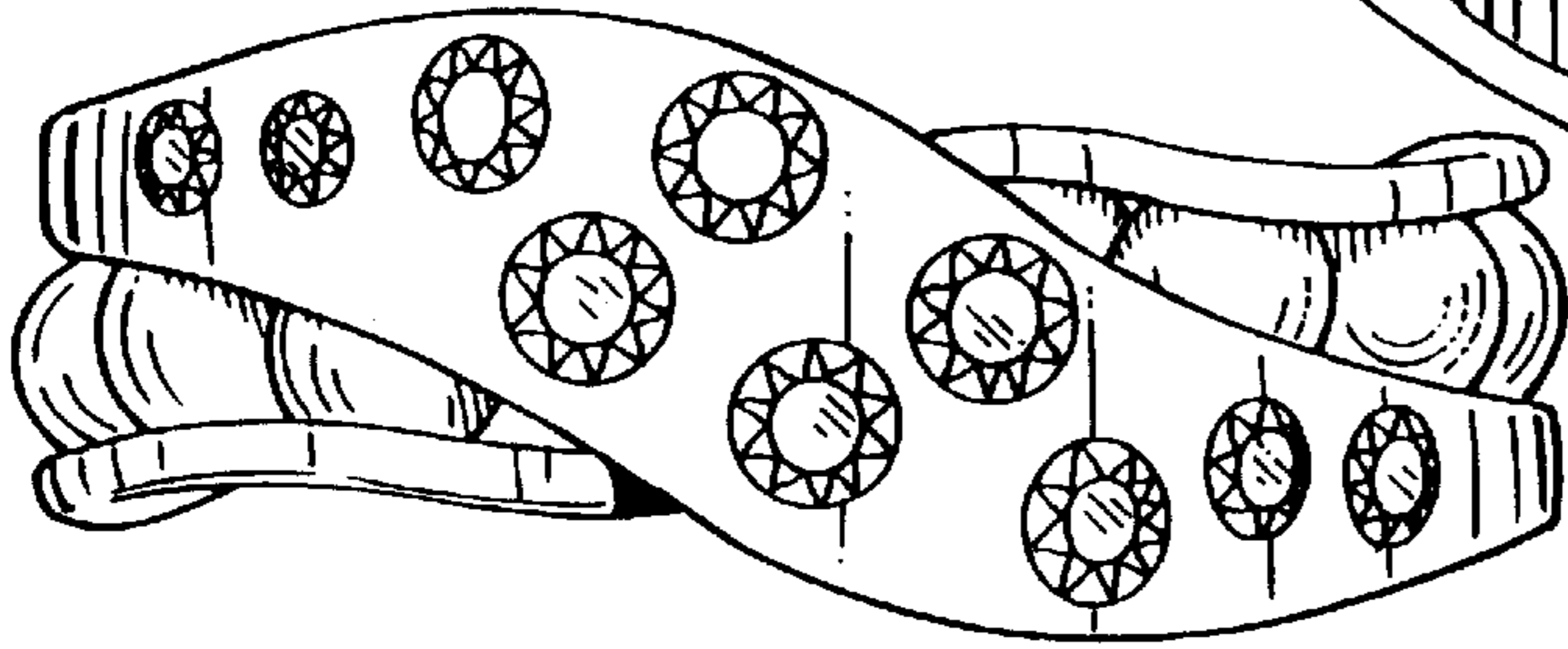

FIG. 28

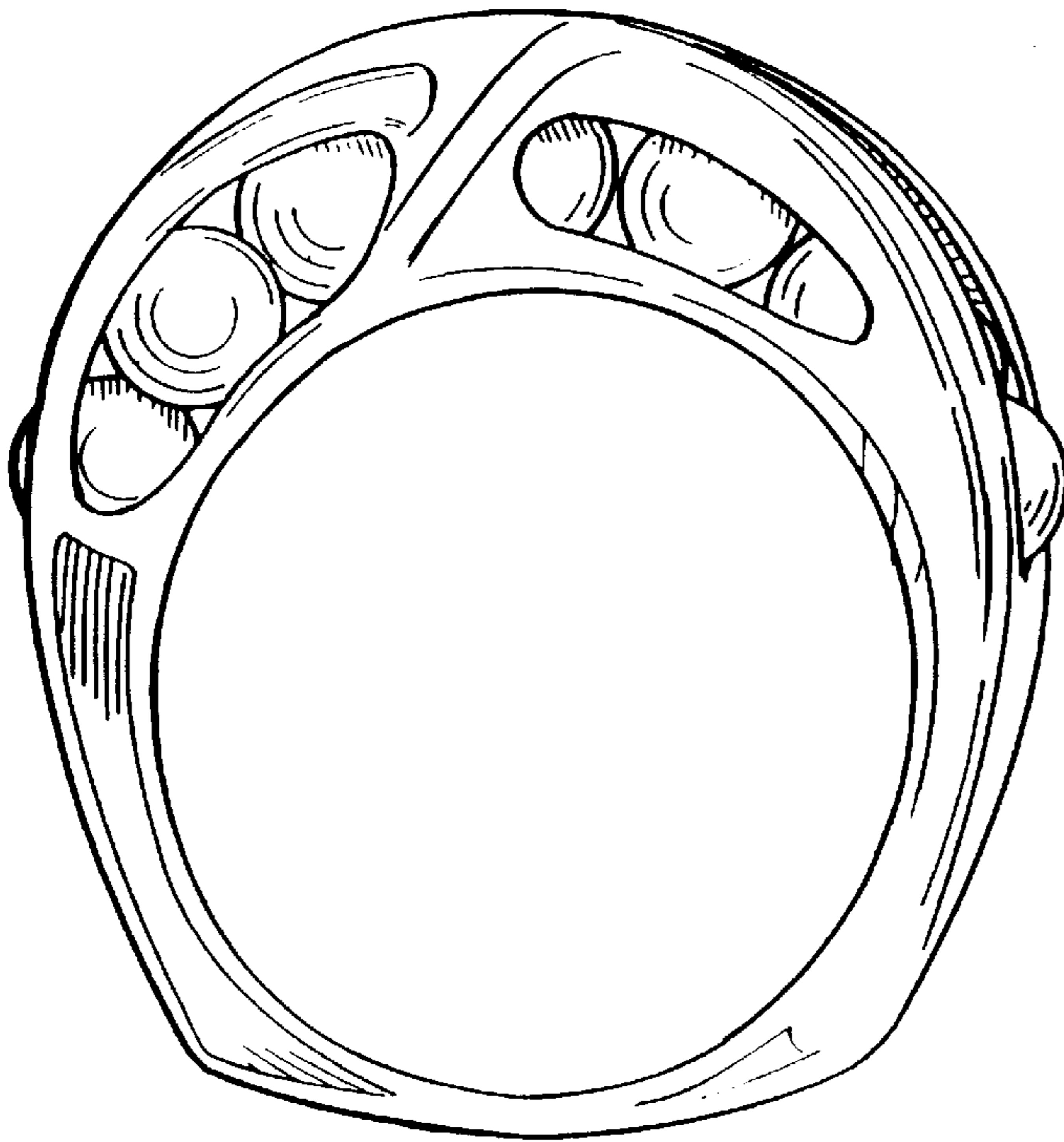

FIG. 29

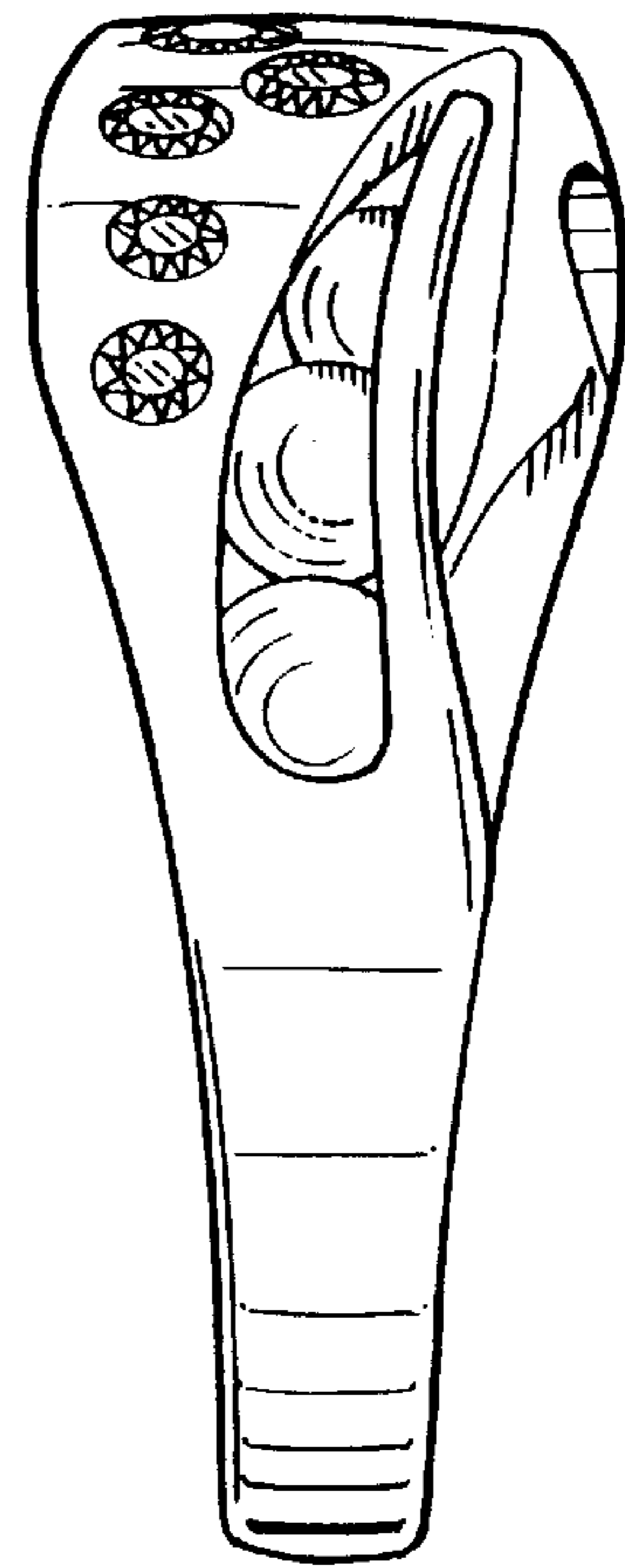

FIG. 30

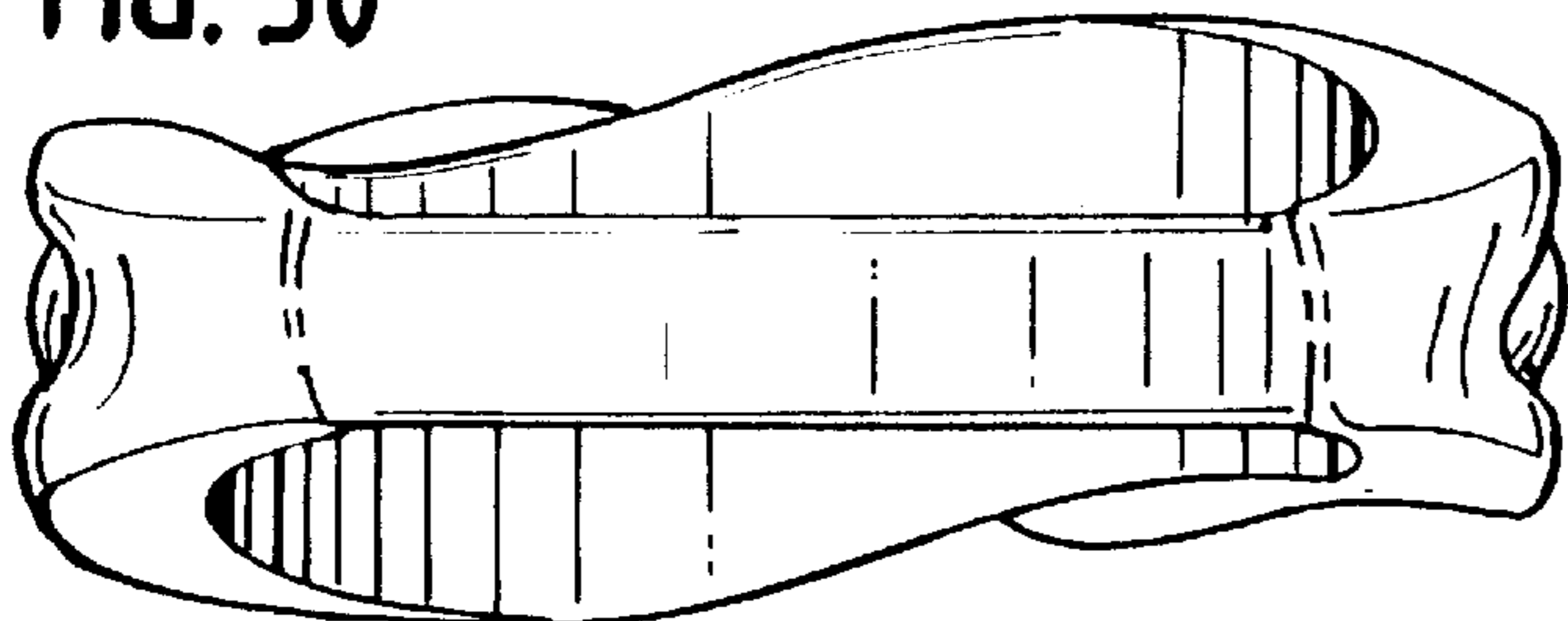



FIG. 31

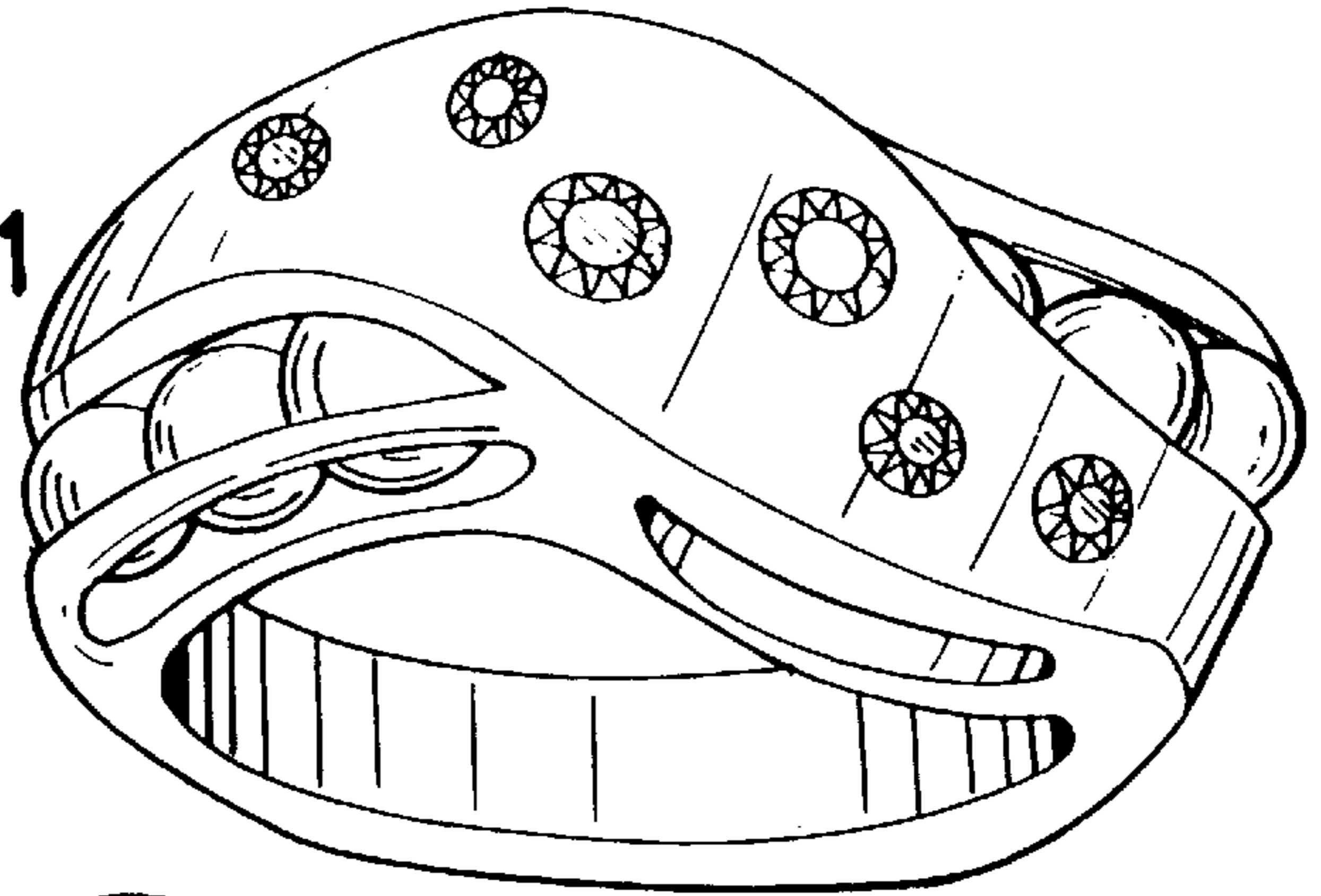

FIG. 32

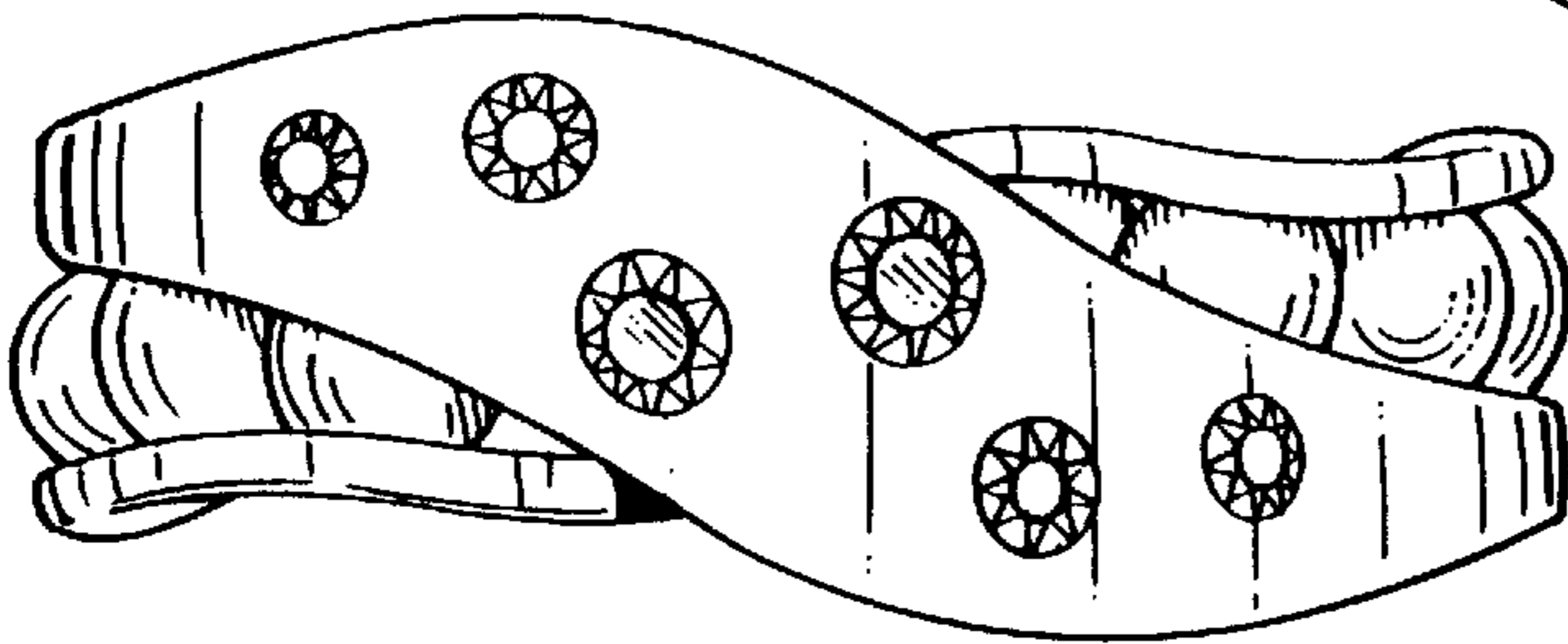

FIG. 33

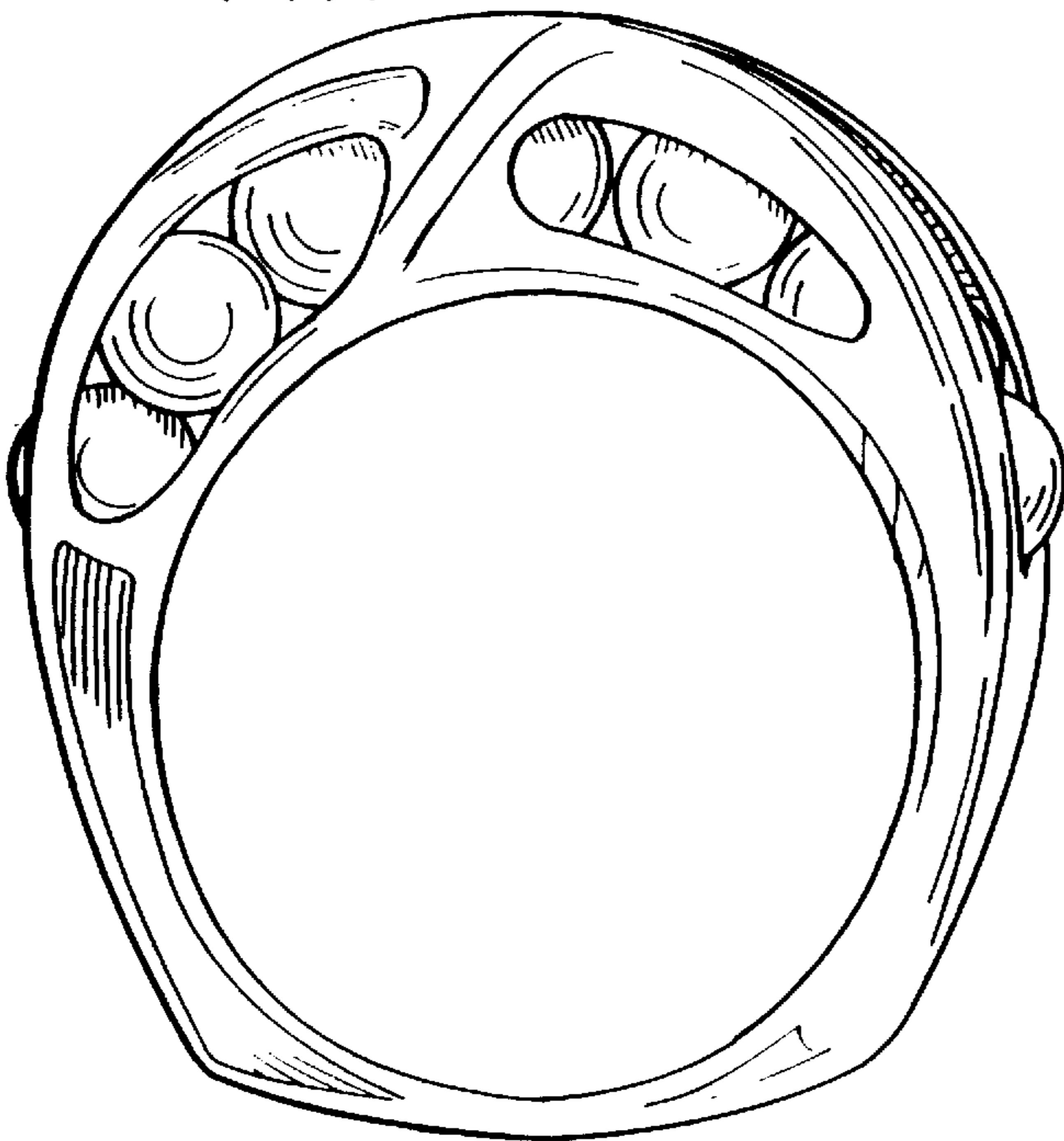

FIG. 34

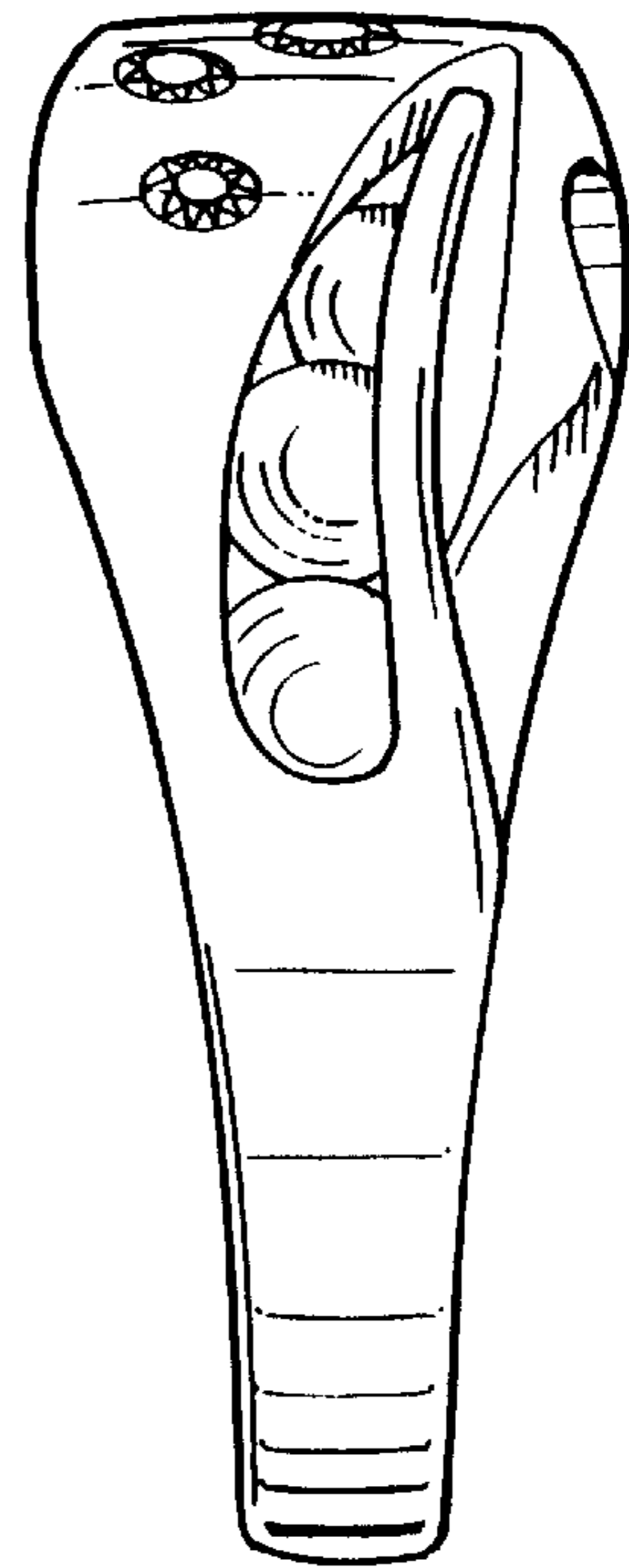

FIG. 35

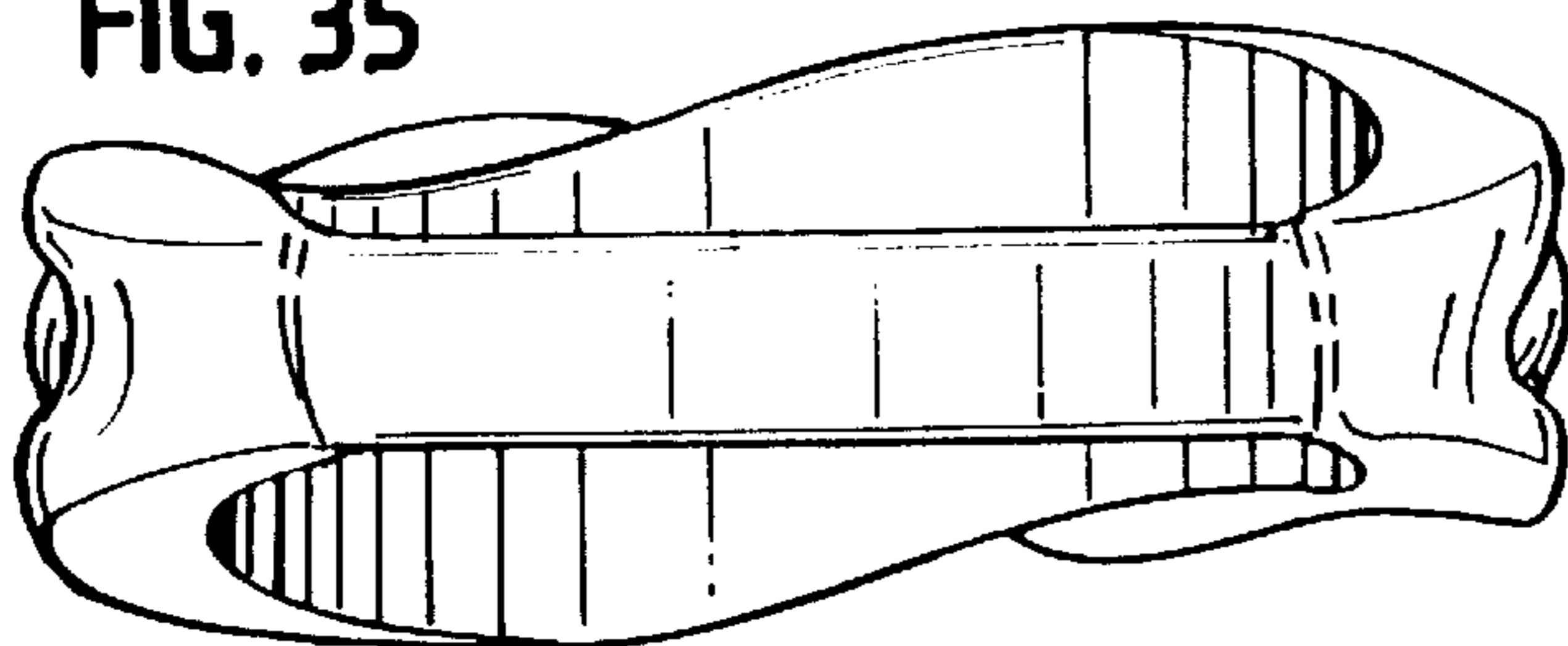

FIG. 36

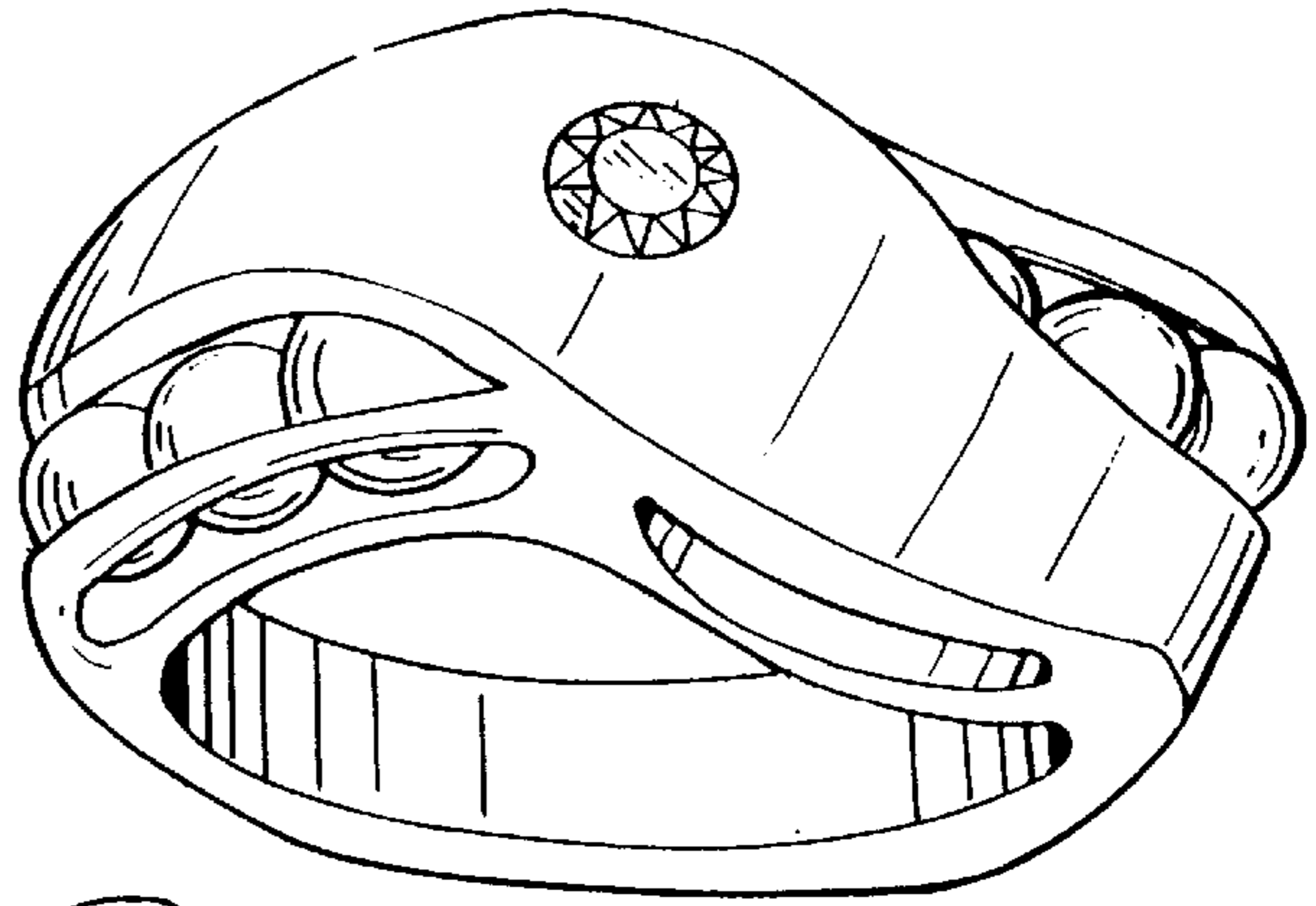

FIG. 37

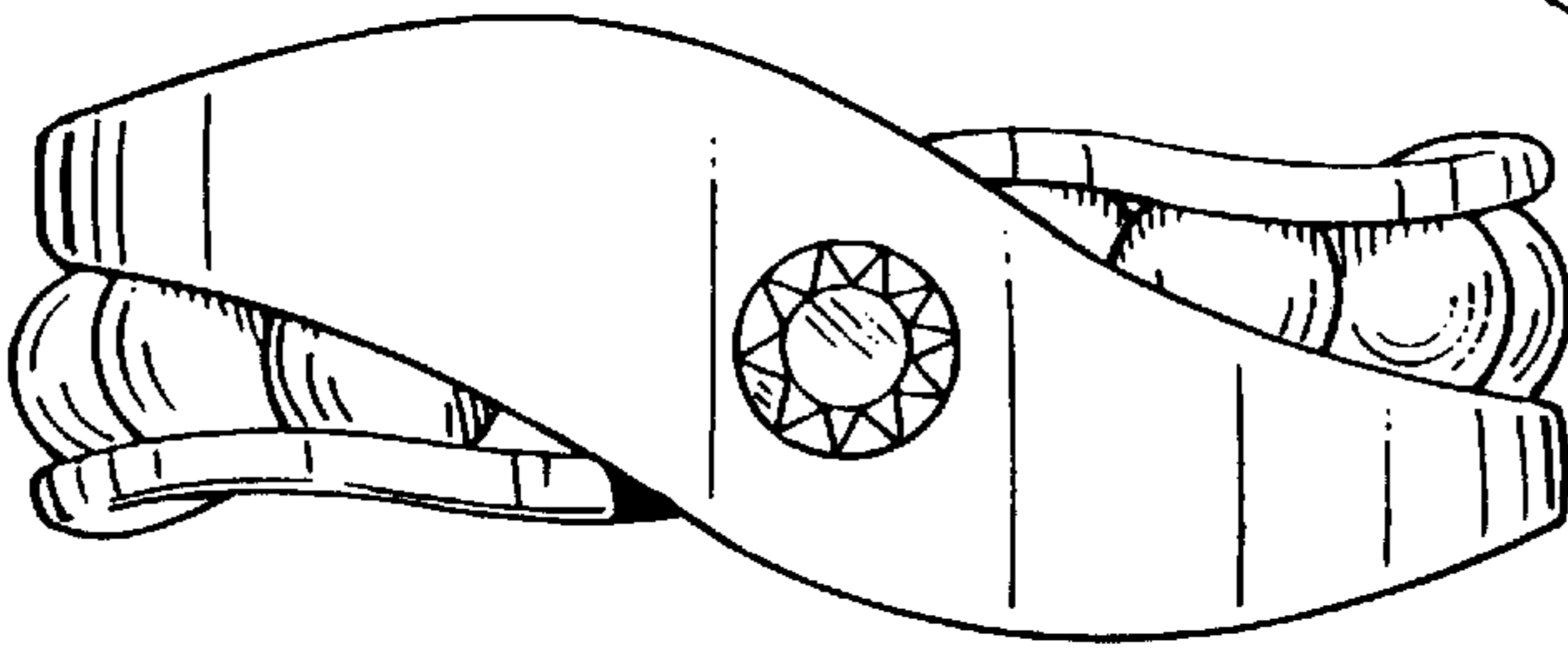

FIG. 38

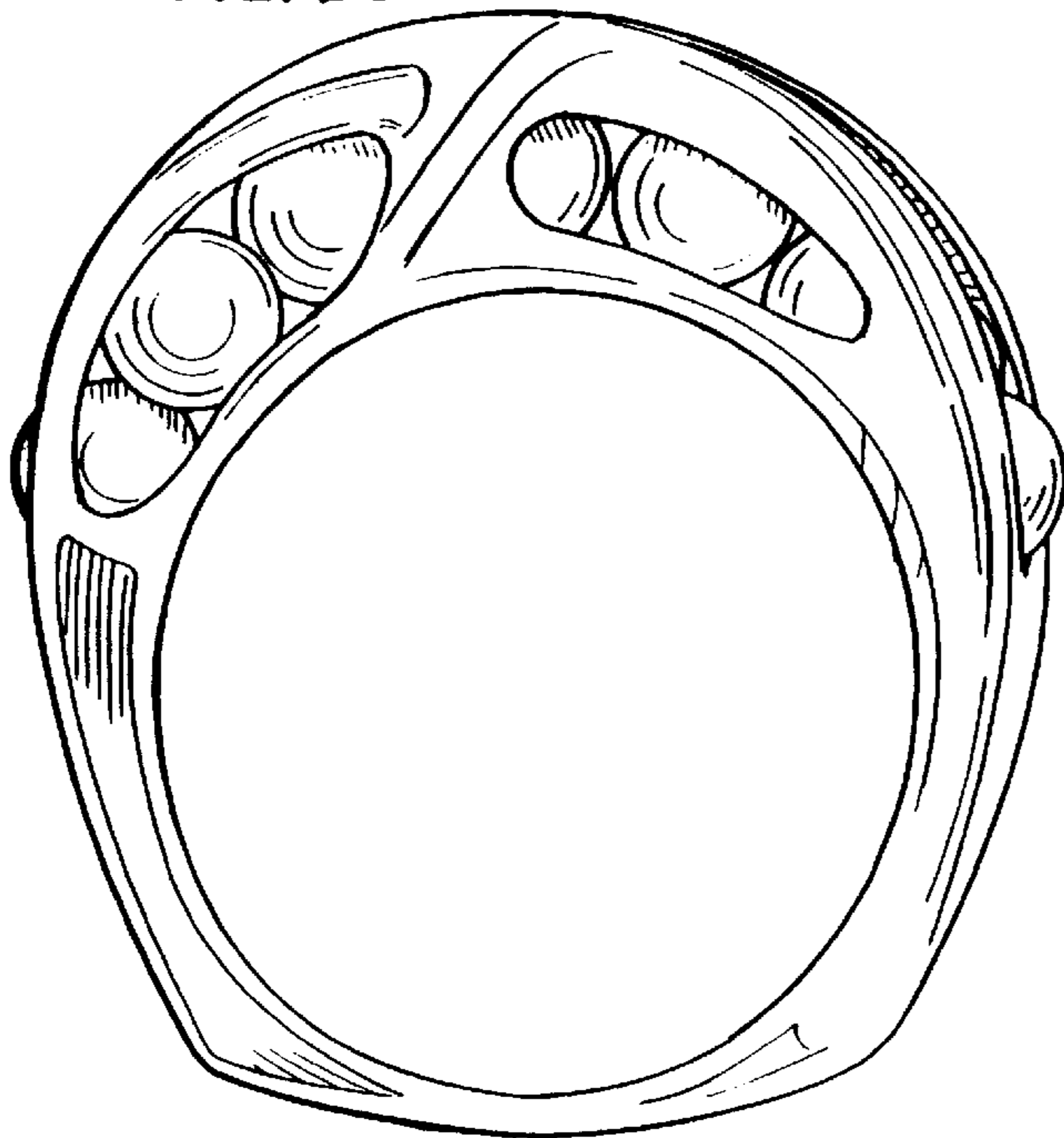

FIG. 39

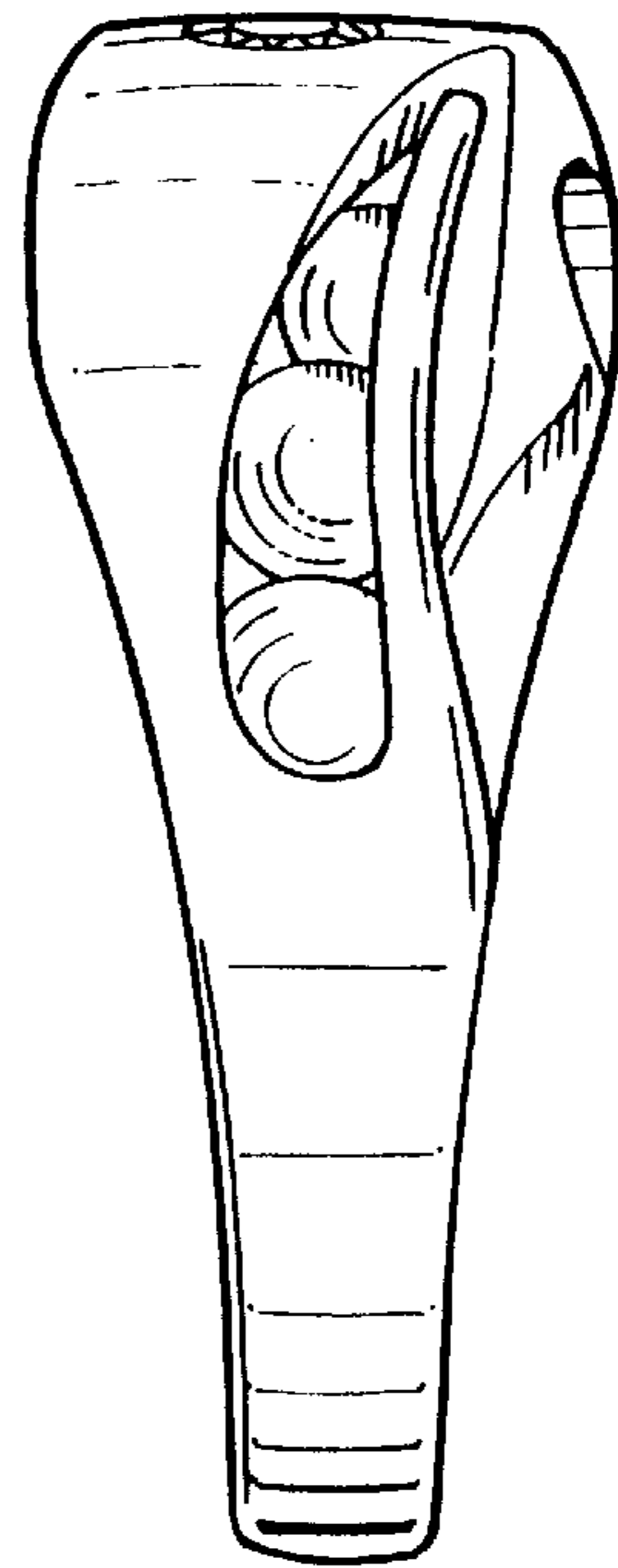

FIG. 40

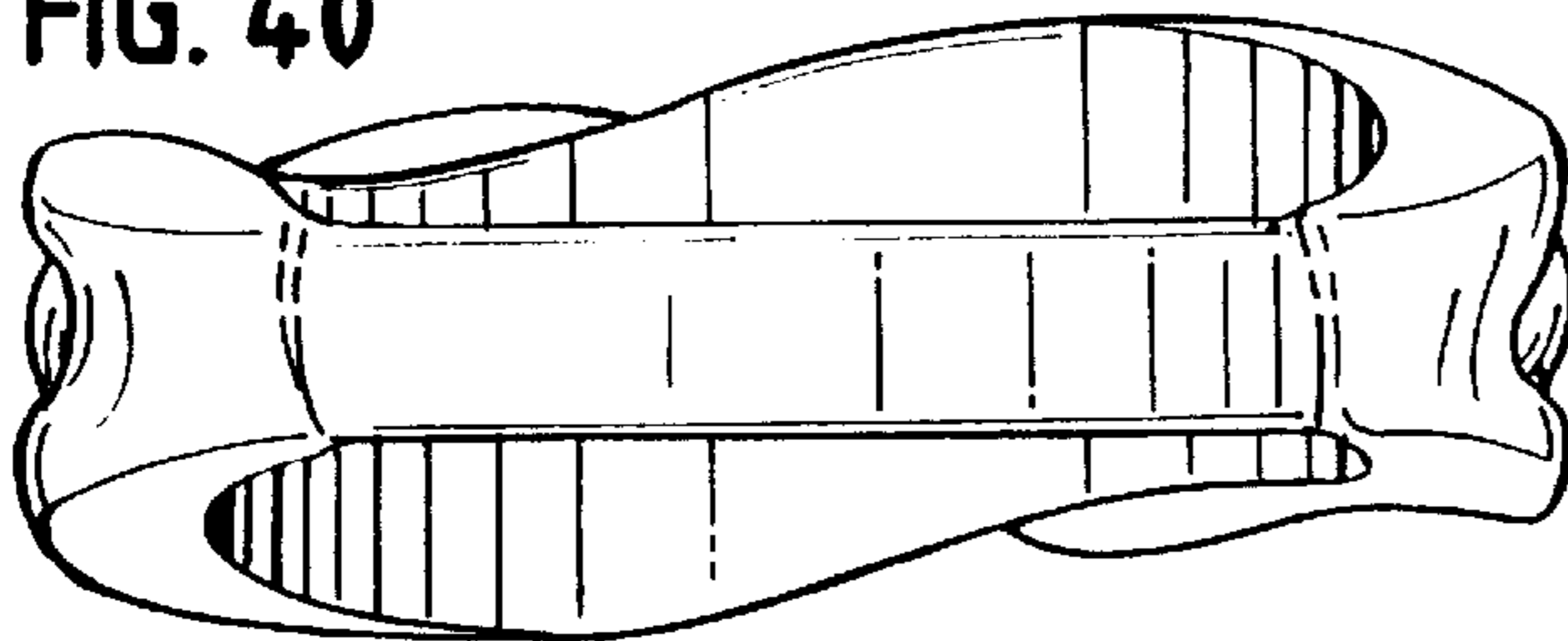

FIG. 41

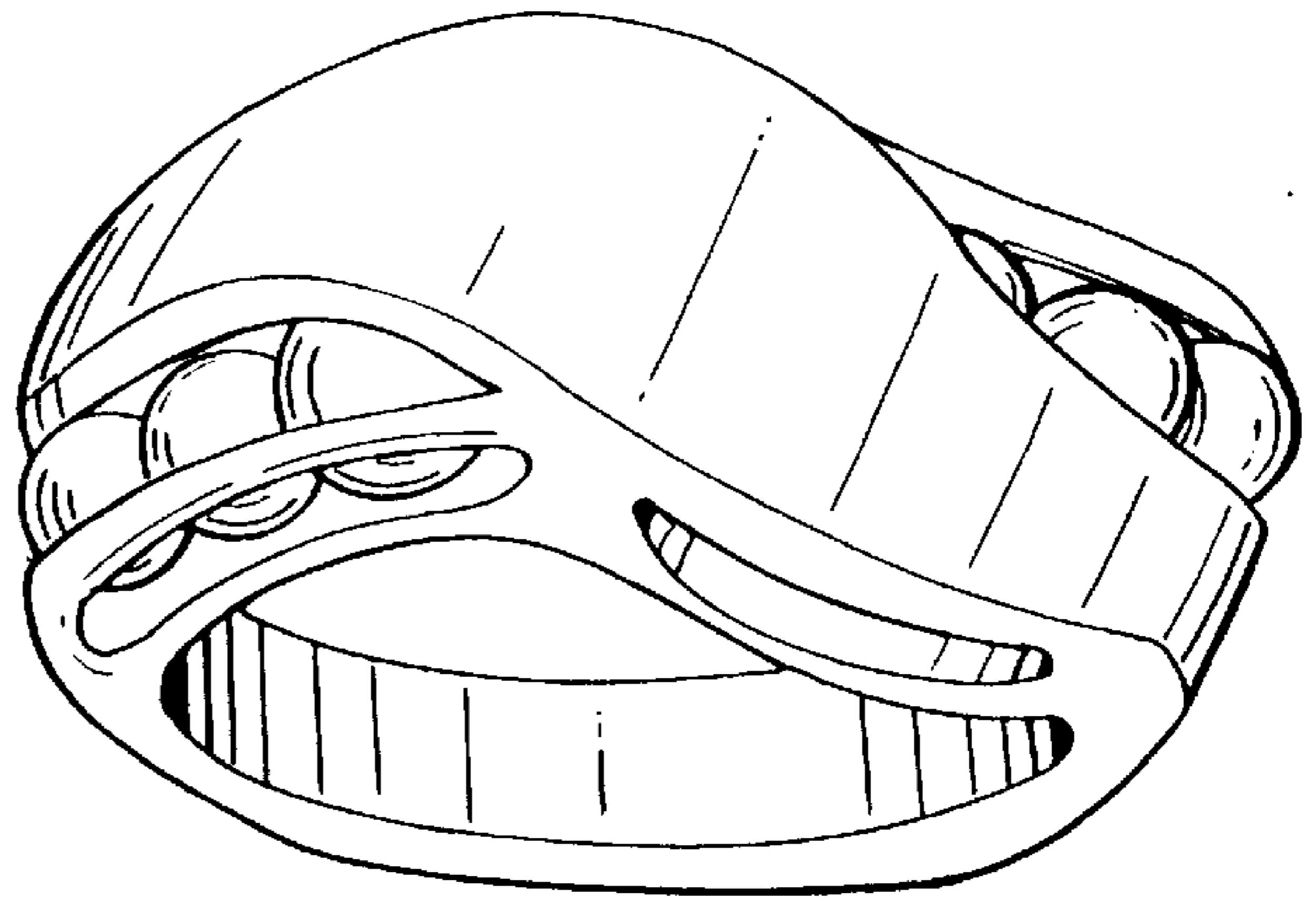

FIG. 42

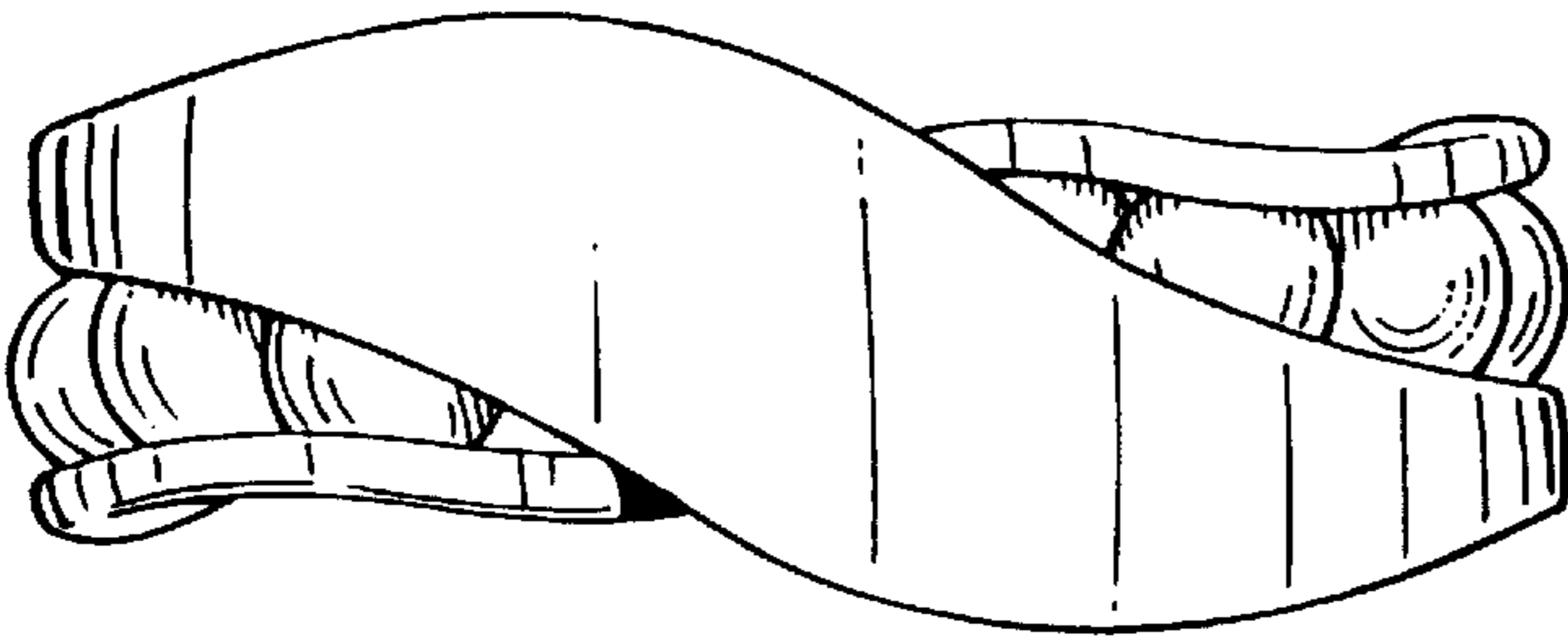

FIG. 43

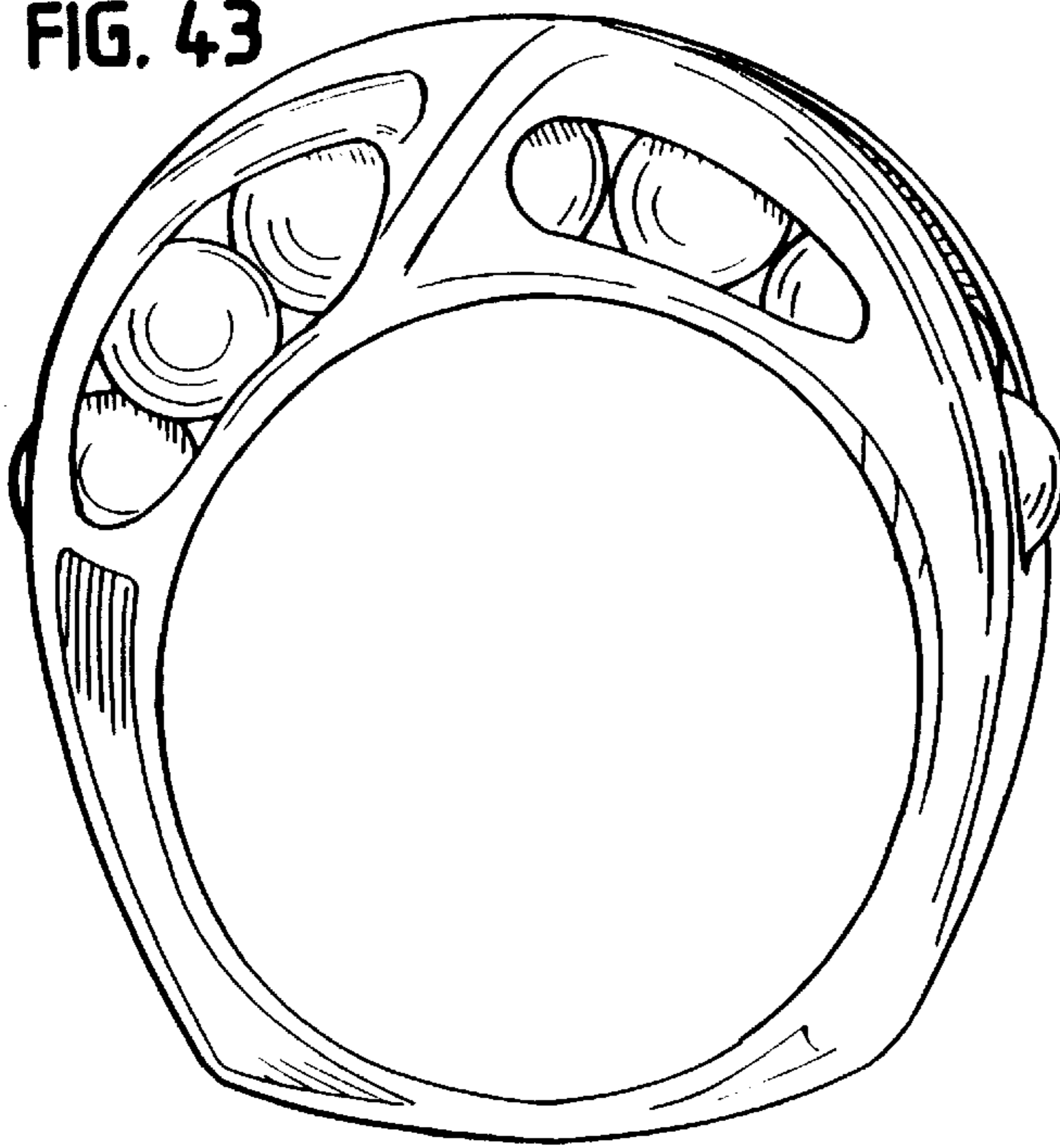

FIG. 44

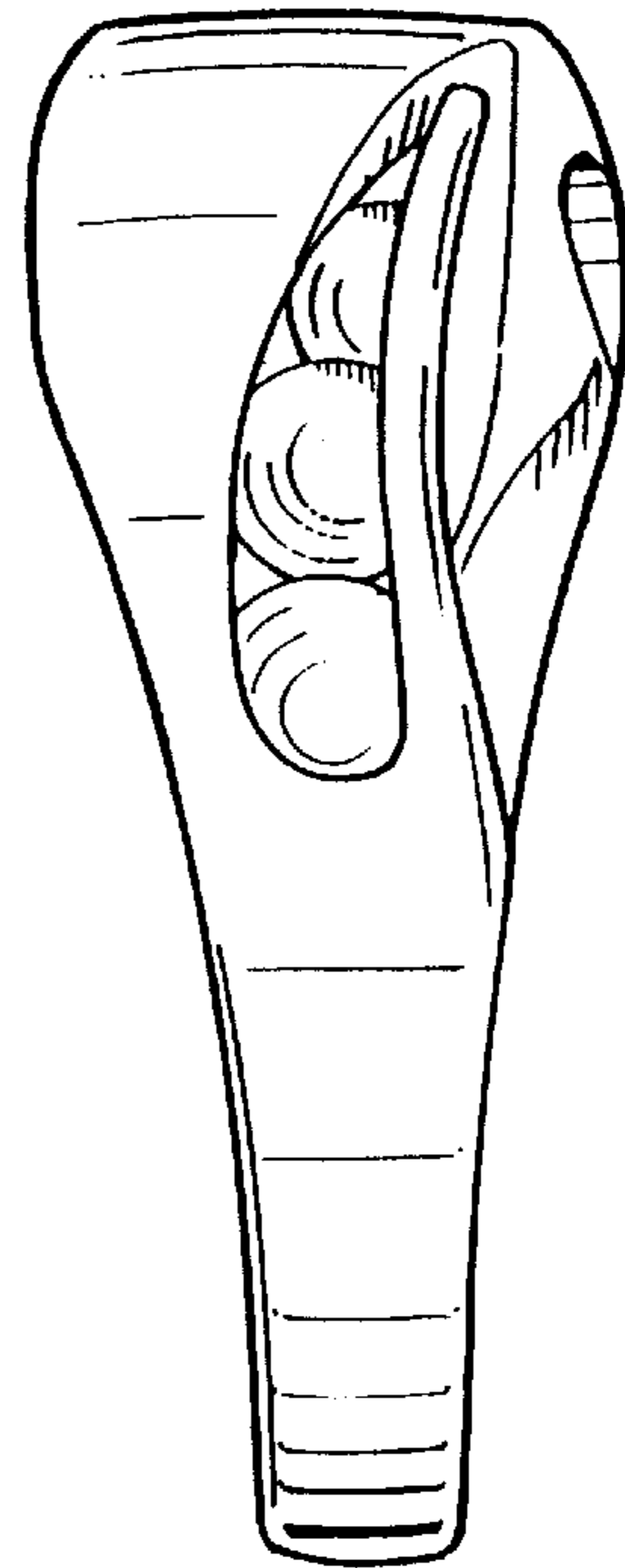

FIG. 45

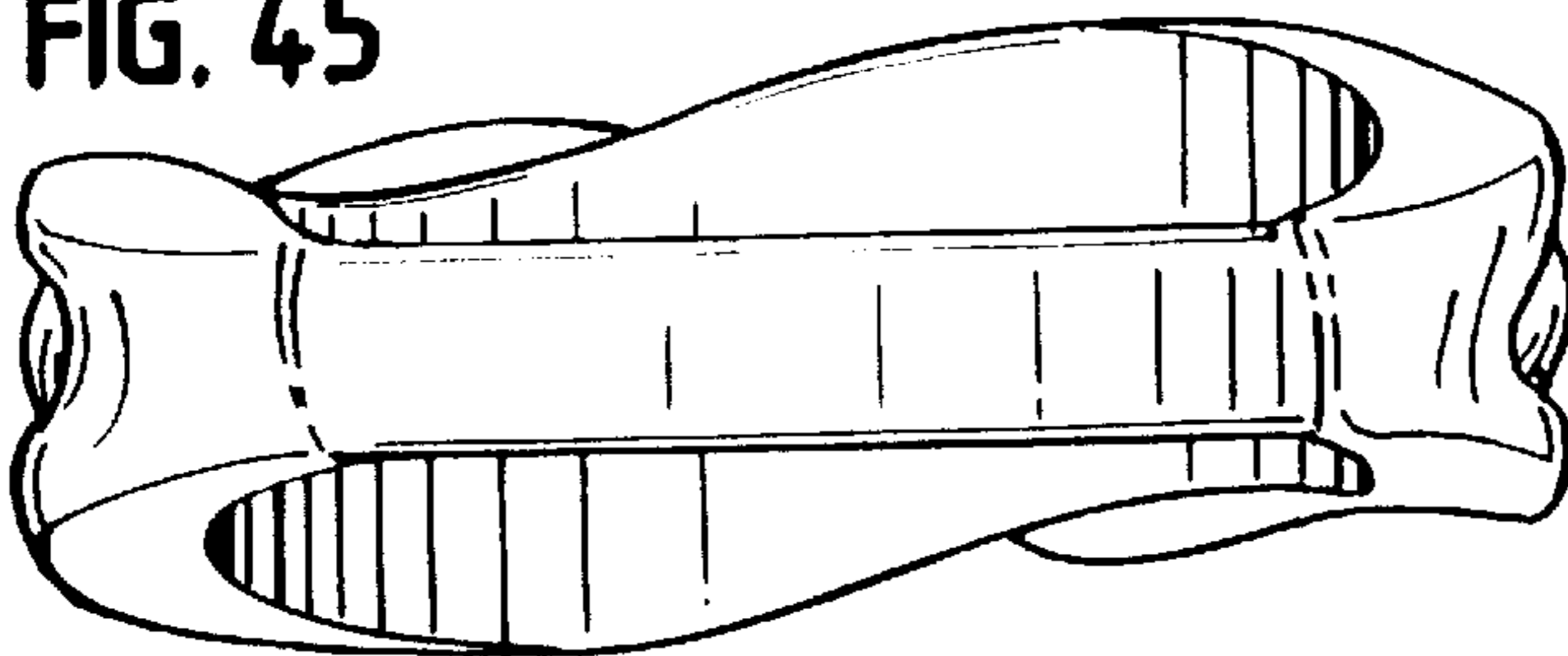

FIG. 46

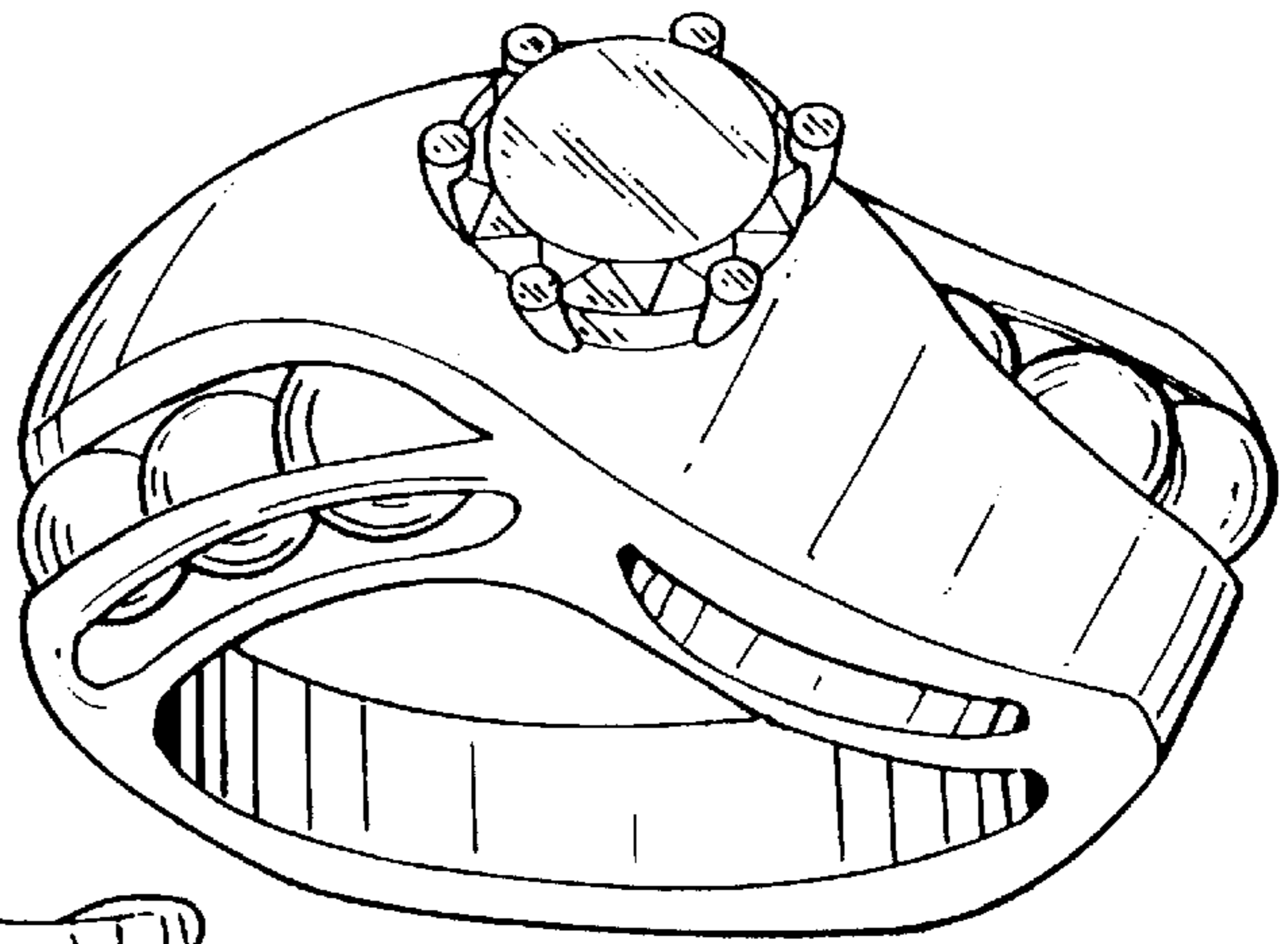

FIG. 47

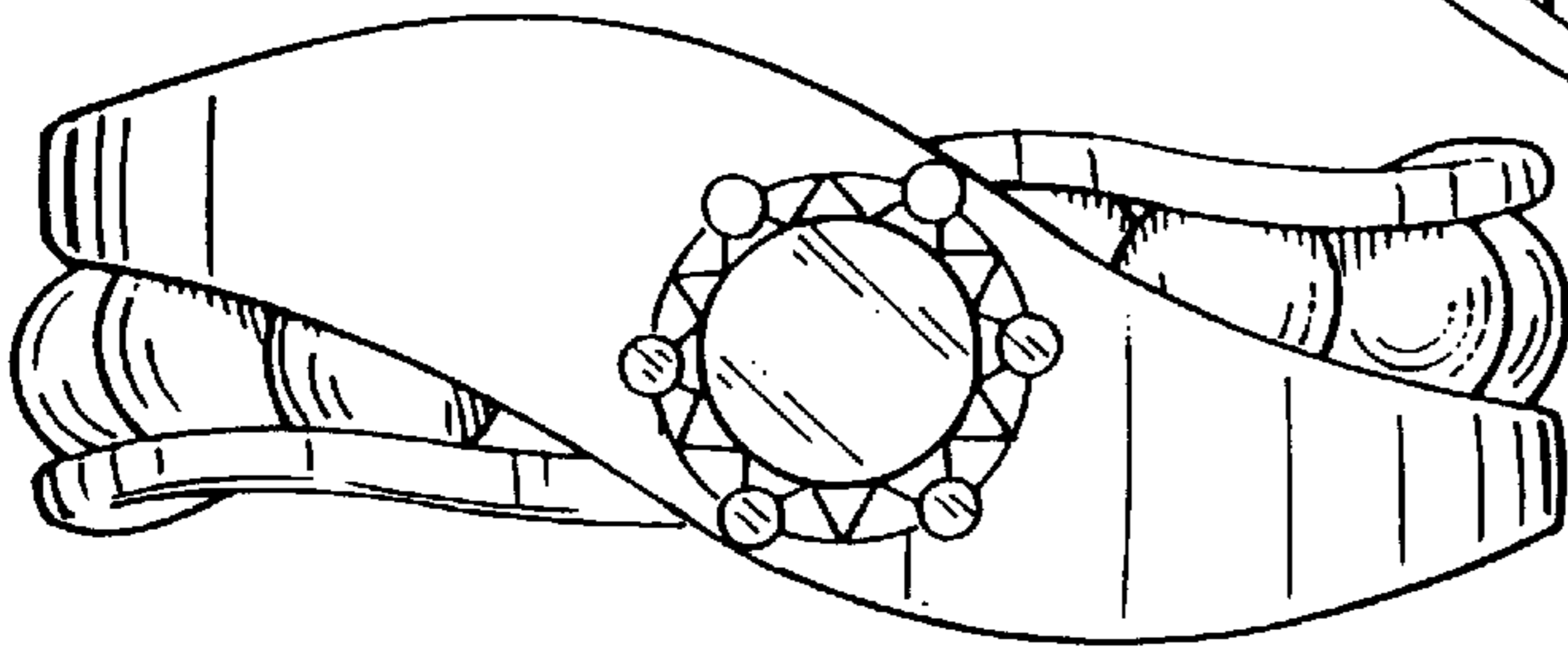

FIG. 48

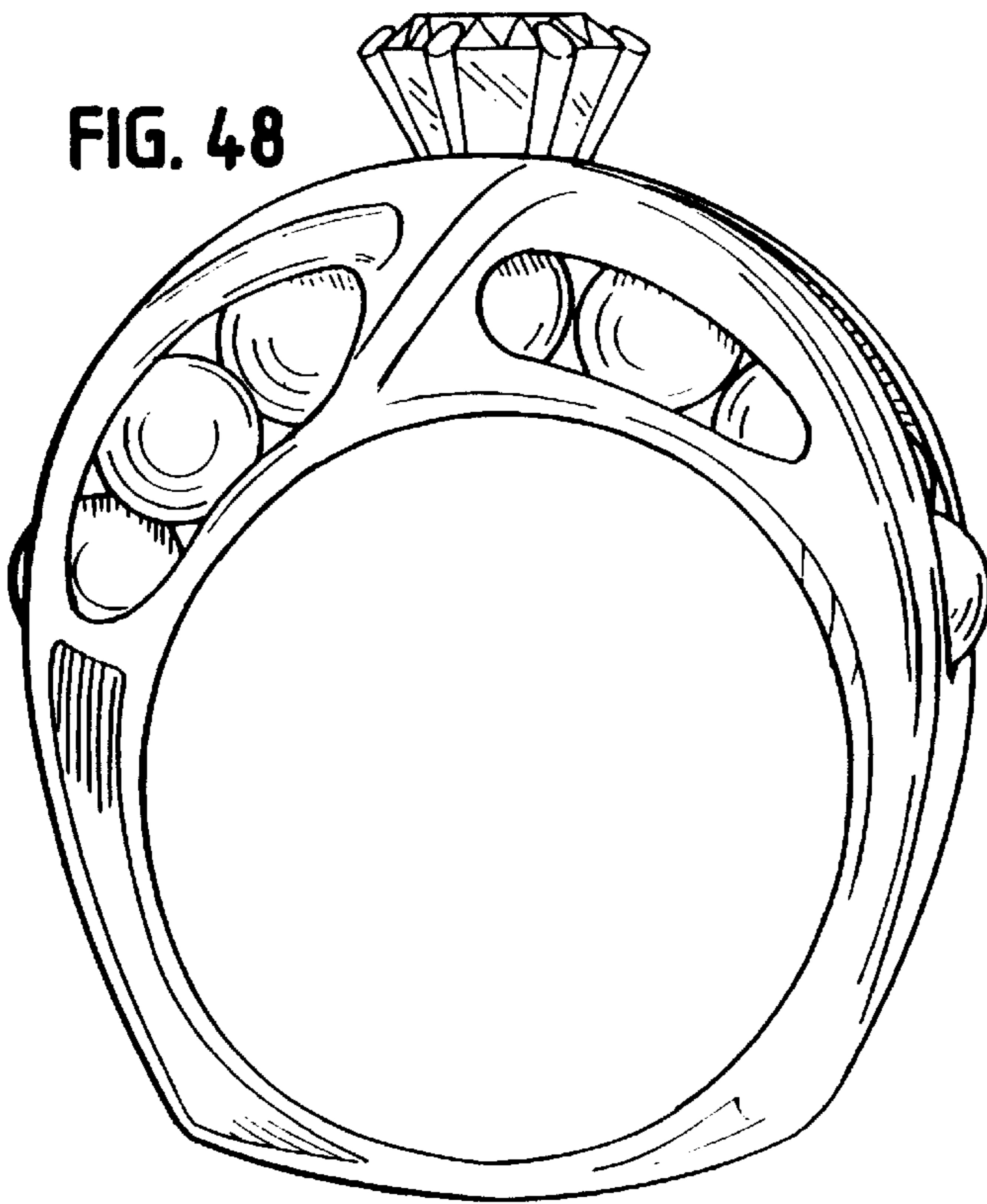

FIG. 49

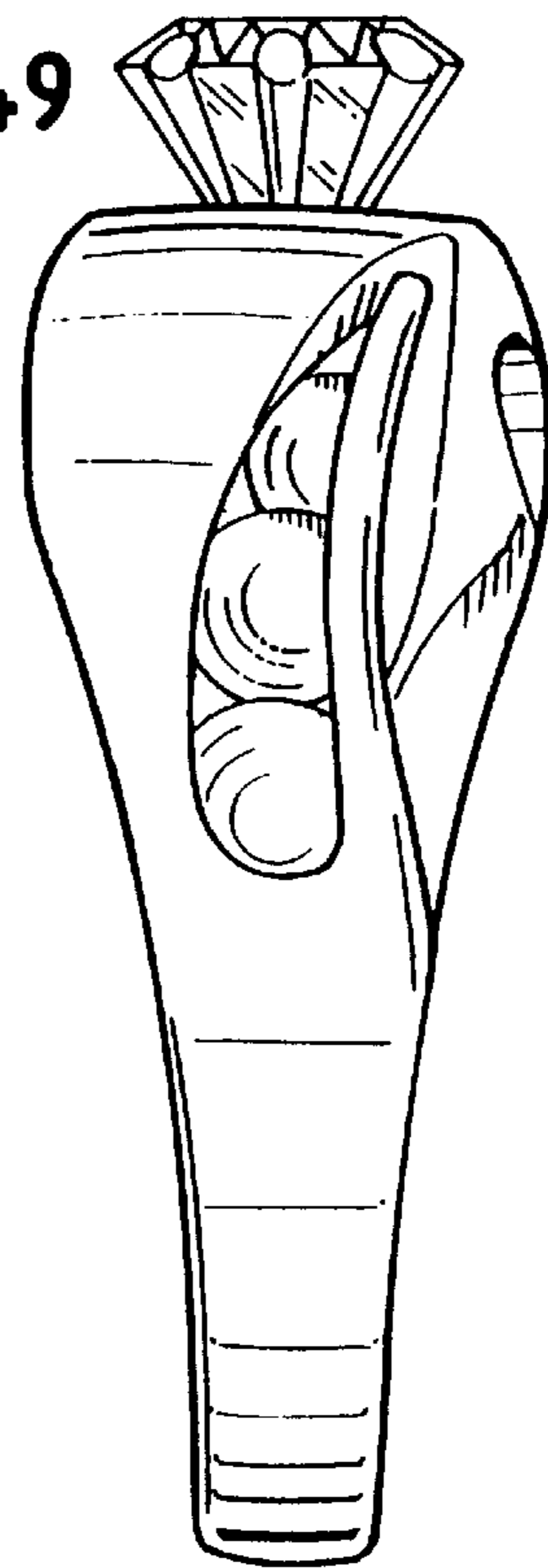

FIG. 50

