



US00D457088S

(12) **United States Design Patent**
Torres

(10) **Patent No.:** **US D457,088 S**

(45) **Date of Patent:** **** May 14, 2002**

(54) **BRACELET**

(75) **Inventor:** **Omar Torres, New York, NY (US)**

(73) **Assignee:** **Movado Watch Company S.A.,
Grenchen (CH)**

(**) **Term:** **14 Years**

(21) **Appl. No.:** **29/143,803**

(22) **Filed:** **Jun. 20, 2001**

Related U.S. Application Data

(63) Continuation-in-part of application No. 29/129,354, filed on Sep. 12, 2000.

(51) **LOC (7) Cl.** **11-01**

(52) **U.S. Cl.** **D11/4**

(58) **Field of Search** D11/1-25, 93,
D11/94, 36, 86; 59/78-84; D10/32; 224/175;
63/1.1, 3, 3.1, 4, 5.1, 9, 11, 38

(56) **References Cited**

U.S. PATENT DOCUMENTS

120,854 A * 11/1871 Carpenter 59/78
434,220 A * 8/1890 Whitney 63/11
1,000,804 A * 8/1911 Harris 59/80
1,085,520 A * 1/1914 Anderson D11/12

1,909,236 A * 10/1933 Bridler 93/15
2,019,053 A * 10/1935 Manne 63/15.1
2,057,913 A * 10/1936 Piacentini 63/9
2,303,294 A * 11/1942 Wagner 59/80
D247,101 S * 1/1978 Durante D11/4
D309,586 S * 7/1990 Ruscitti D11/4
D334,004 S * 3/1993 Mandelbaum D11/76
D393,224 S * 4/1998 Miller D11/4
D442,508 S * 5/2001 Torres D11/4

* cited by examiner

Primary Examiner—Ralf Seifert

(74) *Attorney, Agent, or Firm*—Lawrence E. Apolzon;
Fross Zelnick Lehrman & Zissu, P.C.

(57) **CLAIM**

The ornamental design for a bracelet, as shown and described.

DESCRIPTION

FIG. 1 is a top view.
FIG. 2 is a front view.
FIG. 3 is a side view (the other side being a mirror image).
FIG. 4 is a back view upside-down.
FIG. 5 is an inside bottom view.
FIG. 6 is a bottom view; and,
FIG. 7 is a top perspective view.

1 Claim, 2 Drawing Sheets

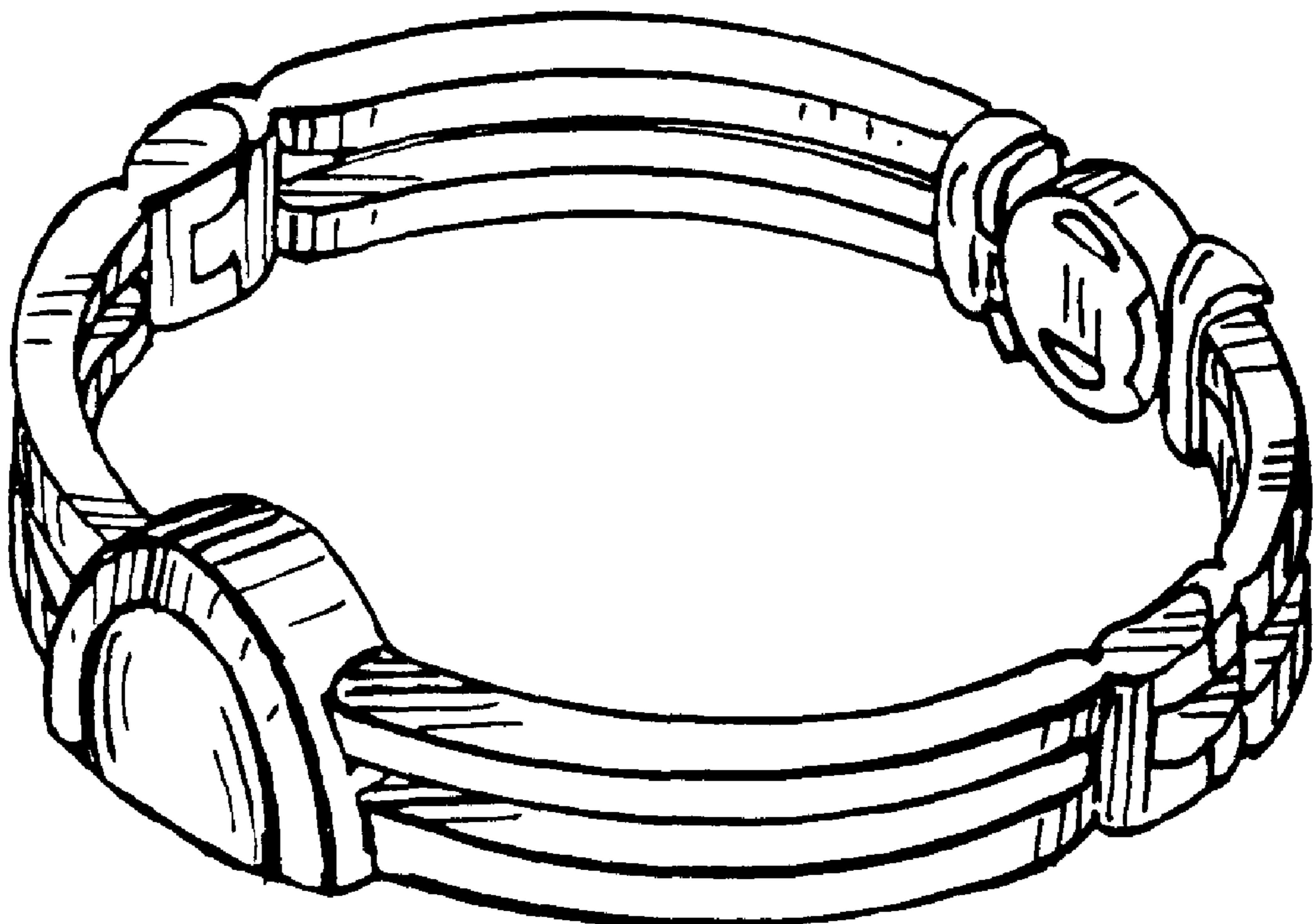

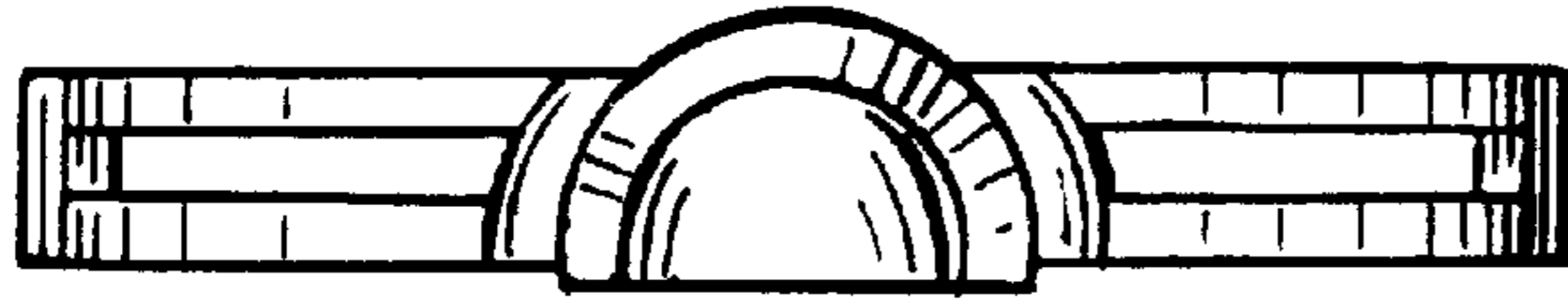

FIG. 1

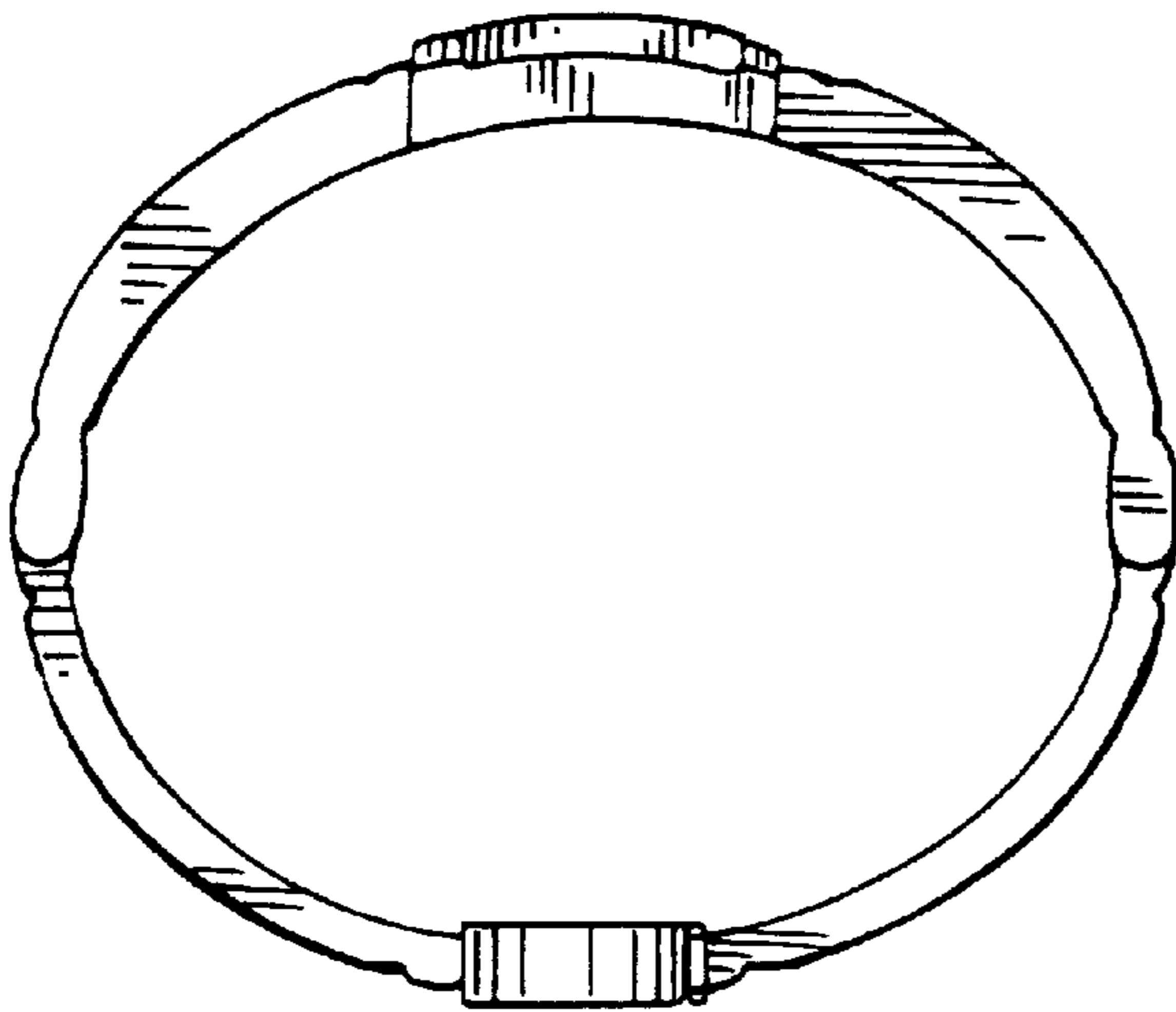

FIG. 2

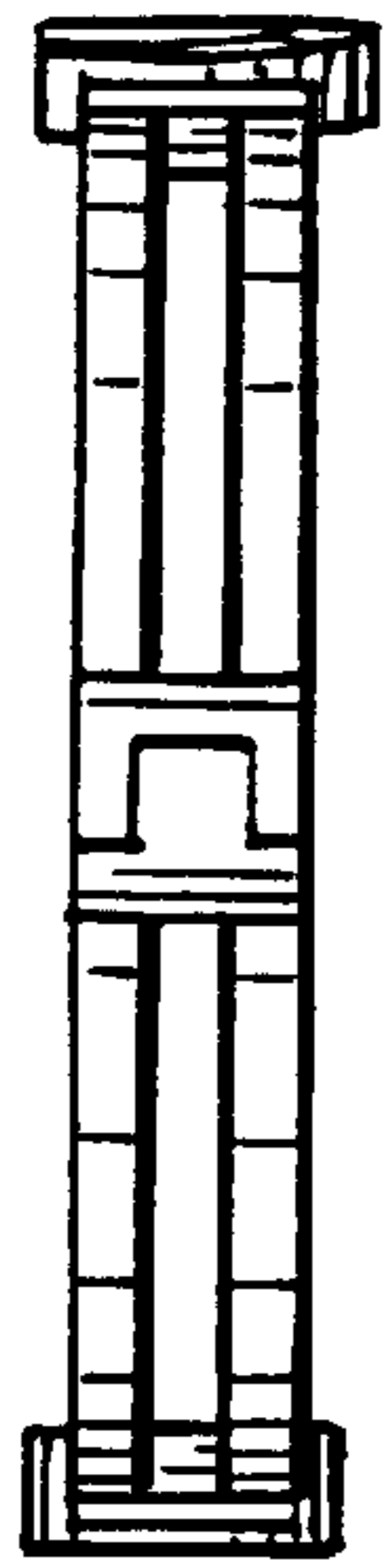

FIG. 3

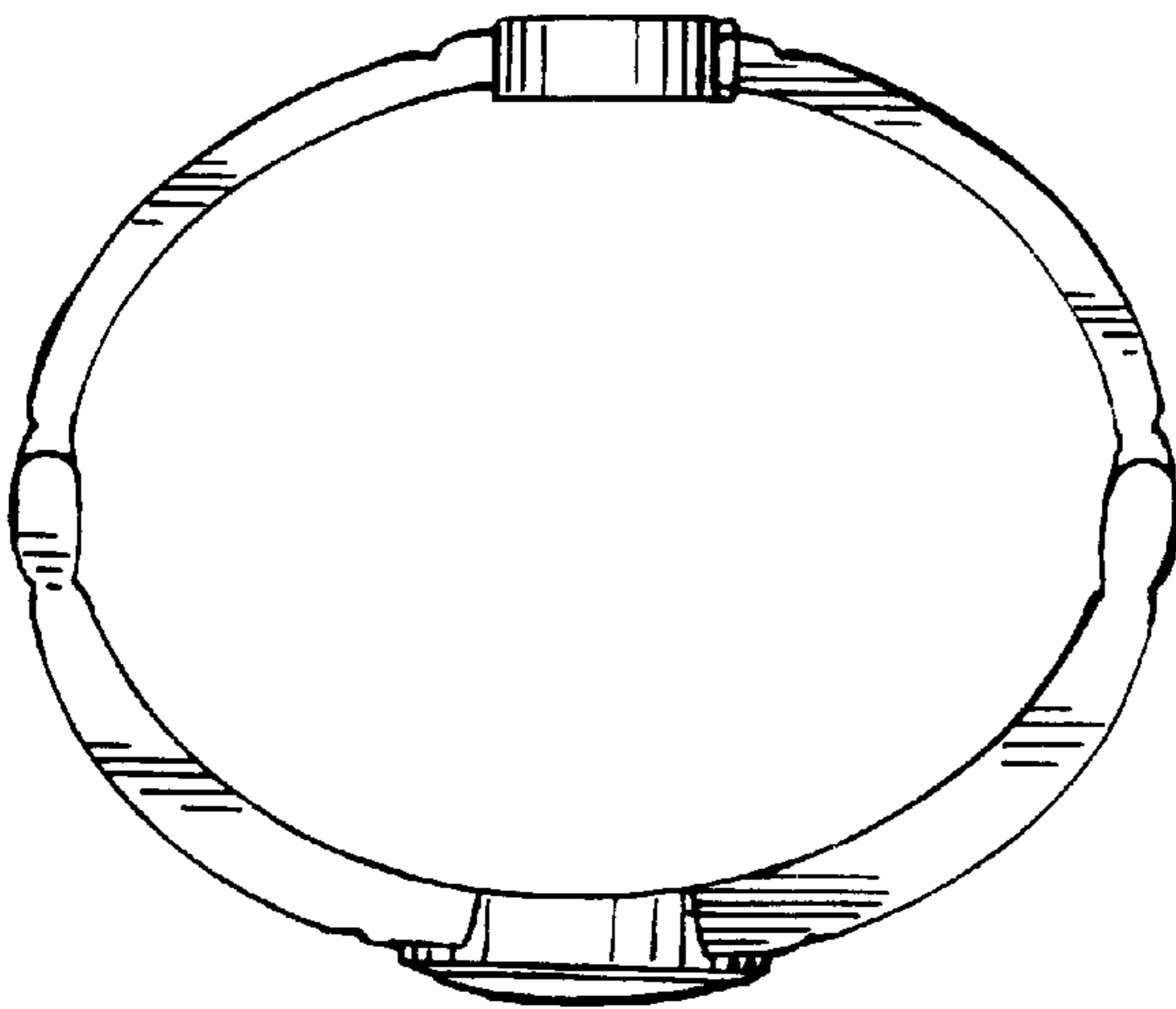

FIG. 4

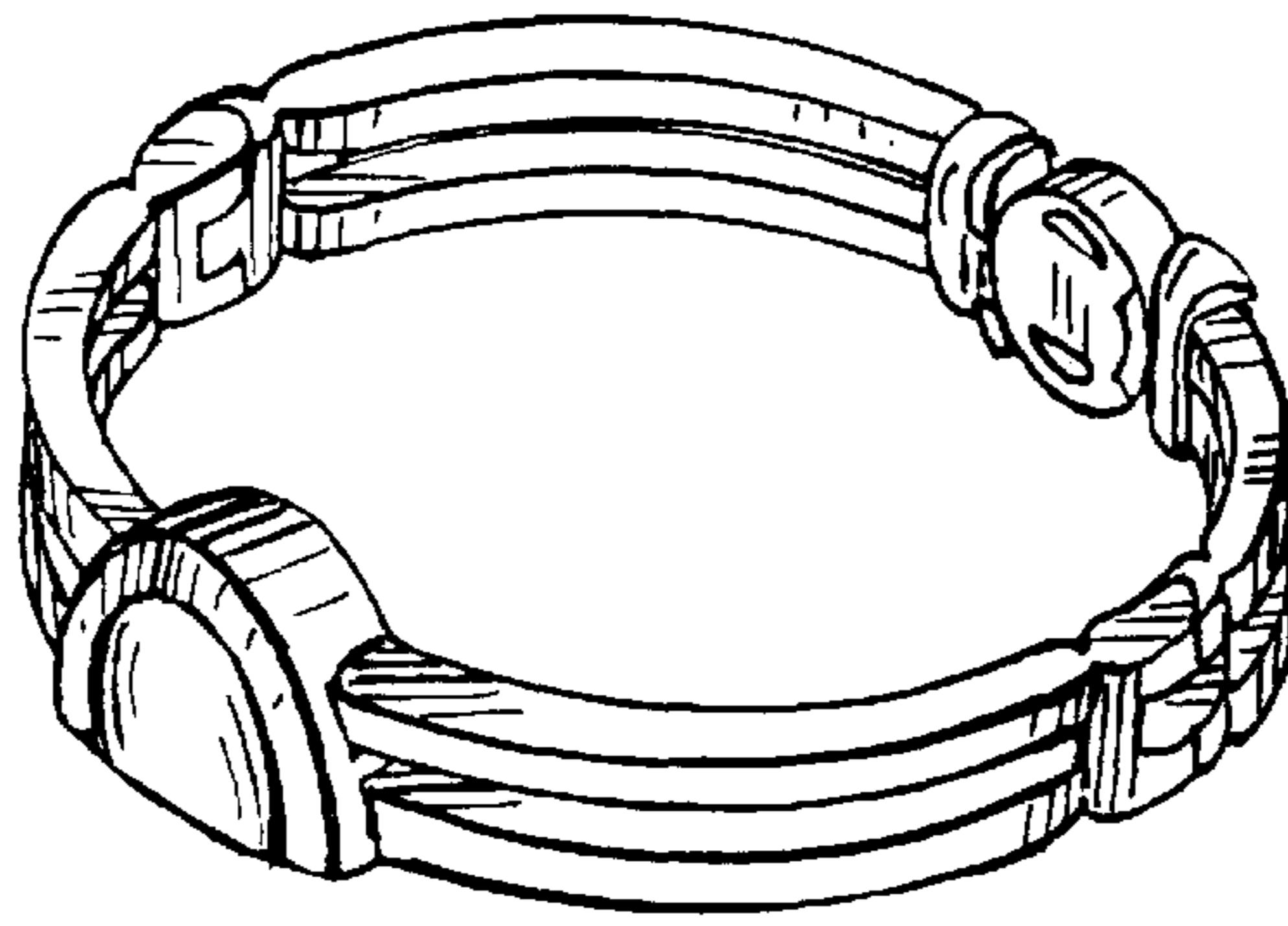

FIG. 7

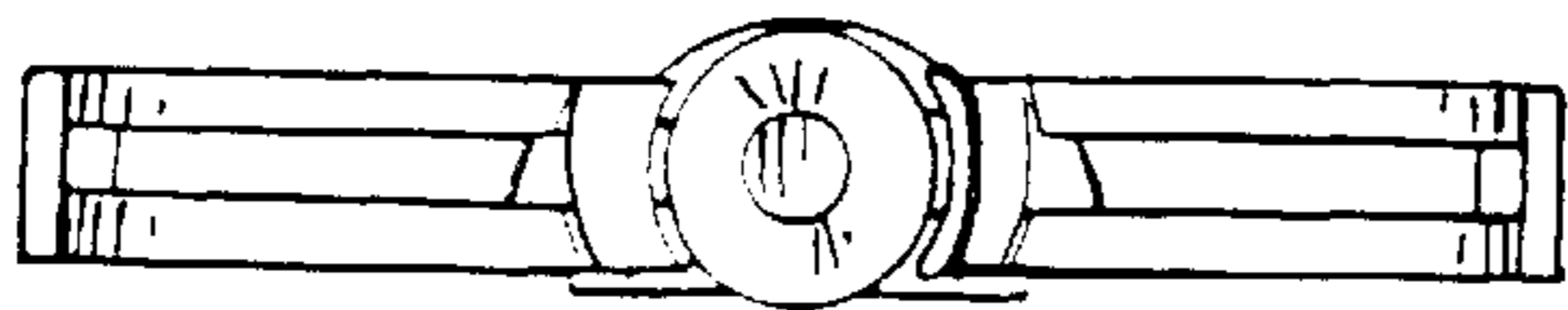

FIG. 6

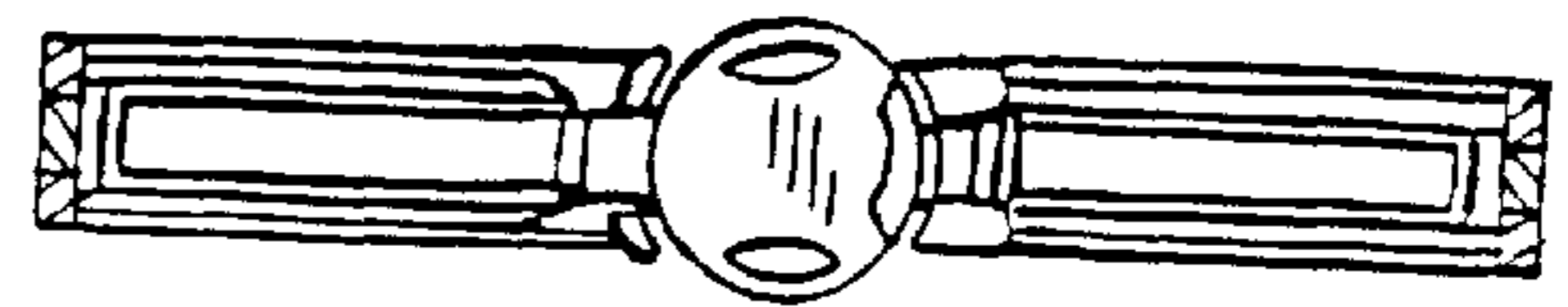

FIG. 5