



US00D457021S

(12) **United States Design Patent**
Wiecek

(10) **Patent No.: US D457,021 S**

(45) **Date of Patent: ** *May 14, 2002**

(54) **FOOTREST ASSEMBLY AND FOOTREST SUPPORT MEMBER FOR A RECLINING FURNITURE ITEM**

4,506,925 A 3/1985 Crum 297/69
4,844,536 A 7/1989 Mizelle 297/68
D337,216 S * 7/1993 Boyd D6/360
D354,177 S * 1/1995 Schwaegerle et al. D6/367

(75) Inventor: **Glenn N. Wiecek**, Shelbyville, KY (US)

* cited by examiner

(73) Assignee: **L&P Property Management Company**, South Gate, CA (US)

Primary Examiner—Doris V. Coles

Assistant Examiner—Mimosa De

(74) *Attorney, Agent, or Firm*—Wood, Herron & Evans, L.L.P.

(*) Notice: This patent is subject to a terminal disclaimer.

(57) **CLAIM**

(**) Term: **14 Years**

The ornamental design for a footrest assembly and footrest support member for a reclining furniture item, as shown and described.

(21) Appl. No.: **29/115,912**

(22) Filed: **Dec. 22, 1999**

DESCRIPTION

(51) **LOC (7) Cl.** **06-06**

(52) **U.S. Cl.** **D6/501**

(58) **Field of Search** D6/334, 335, 360, D6/363, 364, 365, 366, 367, 368, 381, 500-502; 297/68, 232, 423.1, 423.17, 423.18, 423.19, 423.2, 423.25, 423.26, 463.1, DIG. 7

FIG. 1 is a perspective view of a first embodiment of the present invention.

FIG. 2 is a top view thereof;

FIG. 3 is a bottom view thereof;

FIG. 4 is a right side elevational view thereof, the left side elevational view being a mirror image thereof;

FIG. 5 is a front elevational view thereof;

FIG. 6 is a rear elevational view thereof;

FIG. 7 is a perspective view of a second embodiment of the present invention;

FIG. 8 is a top view of FIG. 7;

FIG. 9 is a bottom view of FIG. 7;

FIG. 10 is a right side elevational view of FIG. 7, the left side elevational view being a mirror image thereof;

FIG. 11 is a front elevational view of FIG. 7;

FIG. 12 is a rear elevational view of FIG. 7;

FIG. 13 is a perspective view of a third embodiment of the present invention;

FIG. 14 is a top view of FIG. 13;

FIG. 15 is a bottom view of FIG. 13;

FIG. 16 is a right side elevational view of FIG. 13, the left side elevational view being a mirror image thereof;

FIG. 17 is a front elevational view of FIG. 13;

FIG. 18 is a rear elevational view of FIG. 13;

FIG. 19 is a perspective view of a fourth embodiment of the present invention;

FIG. 20 is a top view of FIG. 19;

(56) **References Cited**

U.S. PATENT DOCUMENTS

276,687 A	5/1883	Hartley	
649,383 A	5/1900	Wilcke	297/70
1,157,992 A	* 10/1915	Lutz	297/232
D64,545 S	* 4/1924	Koken	D6/360
D168,845 S	* 2/1953	Lauterbach et al.	D6/360
D168,857 S	* 2/1953	Ries	D6/360
D173,592 S	* 11/1954	Richardson	D6/360
D177,765 S	* 5/1956	Romito	D6/360
D188,048 S	* 5/1960	Leubner	D6/360
D189,818 S	* 2/1961	Piotraschke	D6/360
3,039,814 A	6/1962	Schliephacke	297/68
D193,183 S	* 7/1962	Fidel	D6/360
D194,459 S	* 1/1963	Dlouhy	D6/360
D198,782 S	* 8/1964	Piotraschke	D6/360
D211,986 S	* 8/1968	Yasutomi	D6/360
3,794,381 A	2/1974	Caldemeyer	297/430
D232,138 S	* 7/1974	Armbruster	D6/360
D239,790 S	* 5/1976	Webb	D6/360

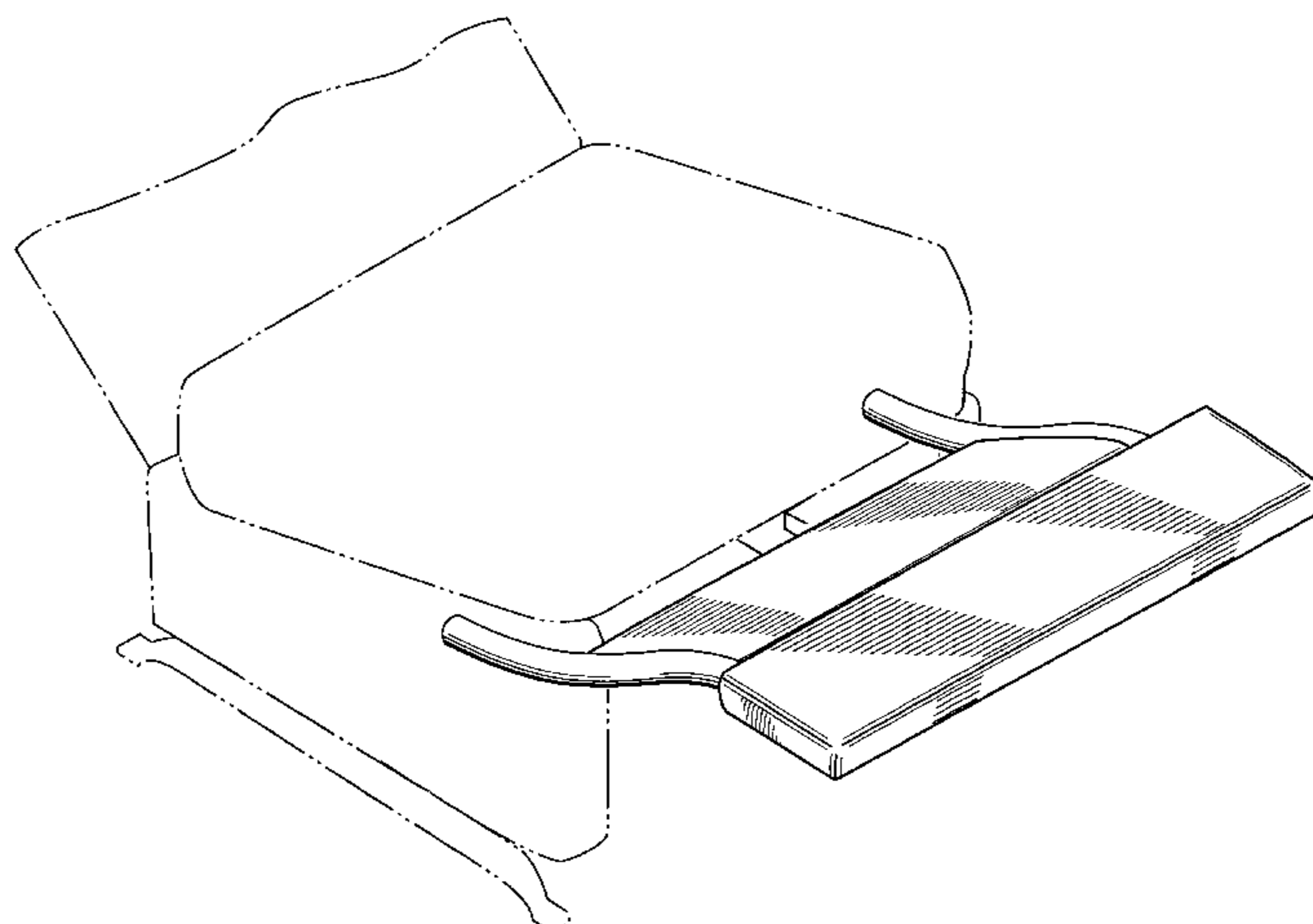

FIG. 21 is a bottom view of FIG. 19;
FIG. 22 is a right side elevational view of FIG. 19, the left side elevational view being a mirror image thereof;
FIG. 23 is a front elevational view of FIG. 19;
FIG. 24 is a rear elevational view of FIG. 19;
FIG. 25 is a perspective view of a fifth embodiment of the present invention;
FIG. 26 is a top view of FIG. 25;
FIG. 27 is a bottom view of FIG. 25;
FIG. 28 is a right side elevational view of FIG. 25, the left side elevational view being a mirror image thereof;
FIG. 29 is a front elevational view of FIG. 25;
FIG. 30 is a rear elevational view of FIG. 25;
FIG. 31 is a perspective view of a sixth embodiment of the present invention;
FIG. 32 is a top view of FIG. 31;
FIG. 33 is a bottom view of FIG. 31;
FIG. 34 is a right side elevational view of FIG. 31, the left side elevational view being a mirror image thereof;
FIG. 35 is a front elevational view of FIG. 31;
FIG. 36 is a rear elevational view of FIG. 31;
FIG. 37 is a perspective view of a seventh embodiment of the present invention;
FIG. 38 is a top view of FIG. 37;
FIG. 39 is a bottom view of FIG. 37;
FIG. 40 is a right side elevational view of FIG. 37, the left side elevational view being a mirror image thereof;
FIG. 41 is a front elevational view of FIG. 37;
FIG. 42 is a rear elevational view of FIG. 37;
FIG. 43 is a perspective view of a eighth embodiment of the present invention;
FIG. 44 is a top view of FIG. 43;
FIG. 45 is a bottom view of FIG. 43;
FIG. 46 is a right side elevational view of FIG. 43, the left side elevational view being a mirror image thereof;
FIG. 47 is a front elevational view of FIG. 43;
FIG. 48 is a rear elevational view of FIG. 43;

FIG. 49 is a perspective view of a ninth embodiment of the present invention;
FIG. 50 is a top view of FIG. 49;
FIG. 51 is a bottom view of FIG. 49;
FIG. 52 is a right side elevational view of FIG. 49, the left side elevational view being a mirror image thereof;
FIG. 53 is a front elevational view of FIG. 49;
FIG. 54 is a rear elevational view of FIG. 49;
FIG. 55 is a perspective view of a tenth embodiment of the present invention;
FIG. 56 is a top view of FIG. 55;
FIG. 57 is a bottom view of FIG. 55;
FIG. 58 is a right side elevational view of FIG. 55, the left side elevational view being a mirror image thereof;
FIG. 59 is a front elevational view of FIG. 55;
FIG. 60 is a rear elevational view of FIG. 55;
FIG. 61 is a perspective view of eleventh embodiment of the present invention;
FIG. 62 is a top view of FIG. 61;
FIG. 63 is a bottom view of FIG. 61;
FIG. 64 is a right side elevational view of FIG. 61, the left side elevational view being a mirror image thereof;
FIG. 65 is a front elevational view of FIG. 61;
FIG. 66 is a rear elevational view of FIG. 61;
FIG. 67 is a perspective view of twelfth embodiment of the present invention;
FIG. 68 is a top view of FIG. 67;
FIG. 69 is a bottom view of FIG. 67;
FIG. 70 is a right side elevational view of FIG. 67, the left side elevational view being a mirror image thereof;
FIG. 71 is a front elevational view of FIG. 67; and,
FIG. 72 is a rear elevational view of FIG. 67.
The elements shown in broken lines are for environmental purposes and relate to elements which do not form part of the claimed invention.

1 Claim, 36 Drawing Sheets

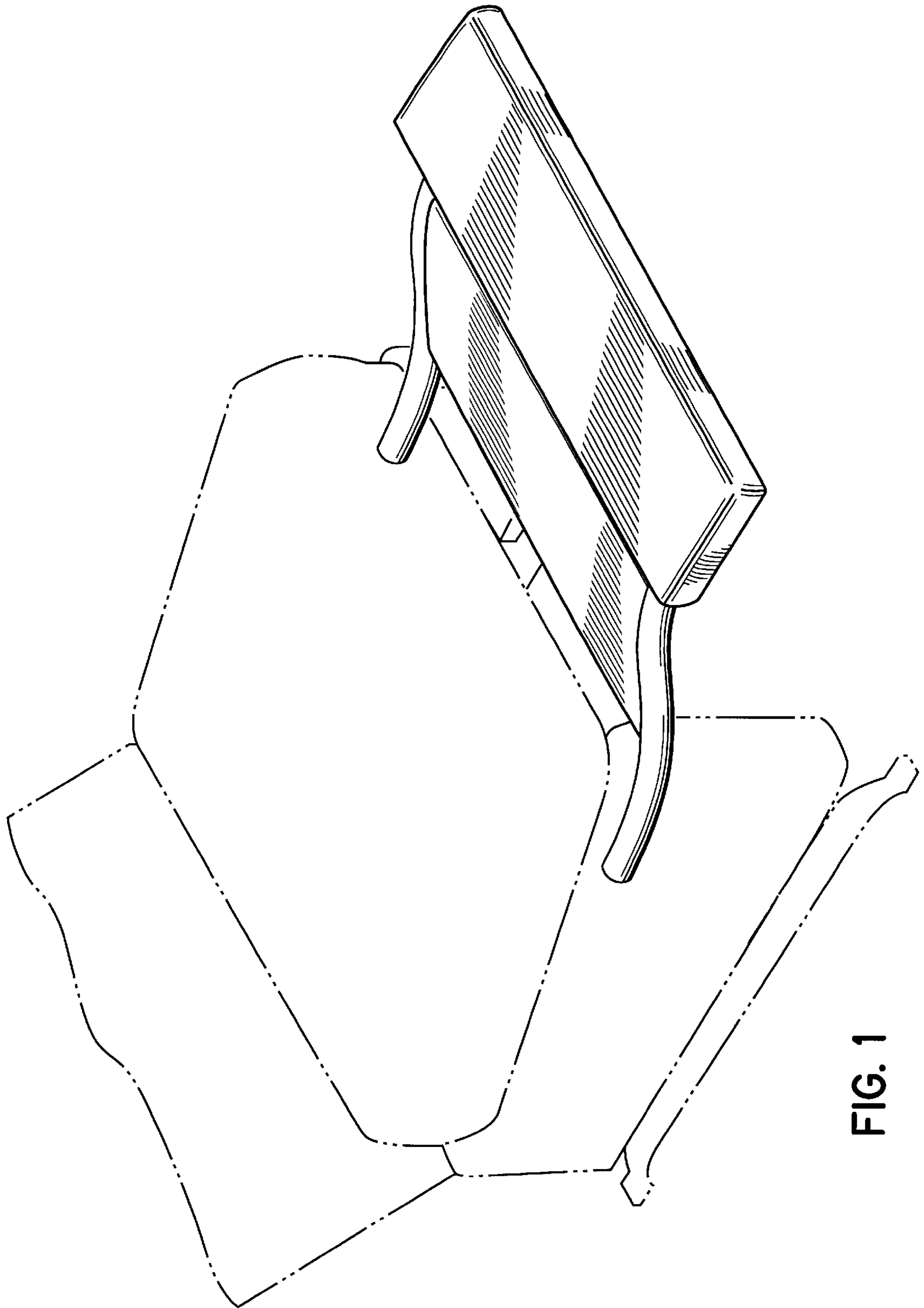

FIG. 1

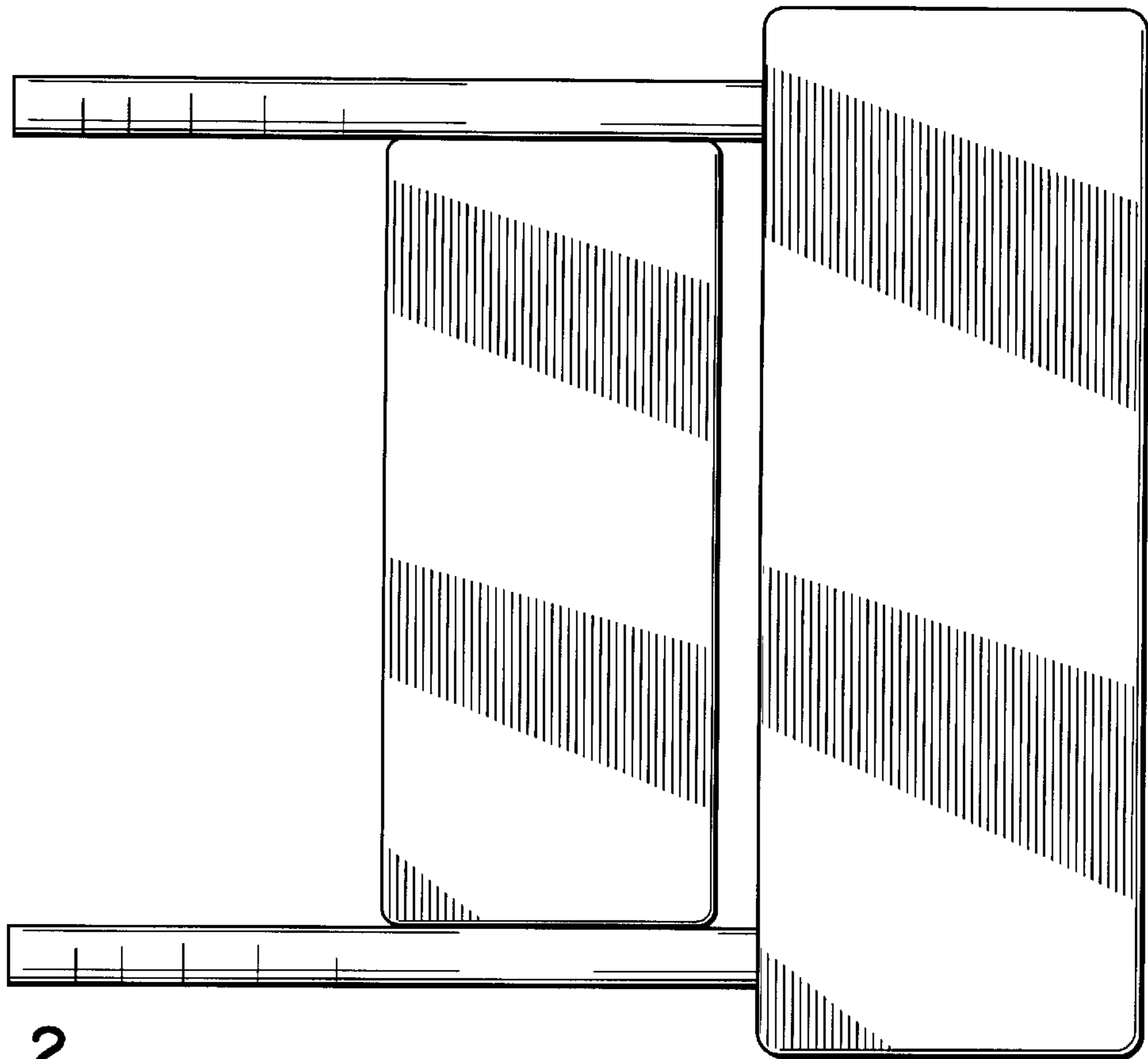

FIG. 2

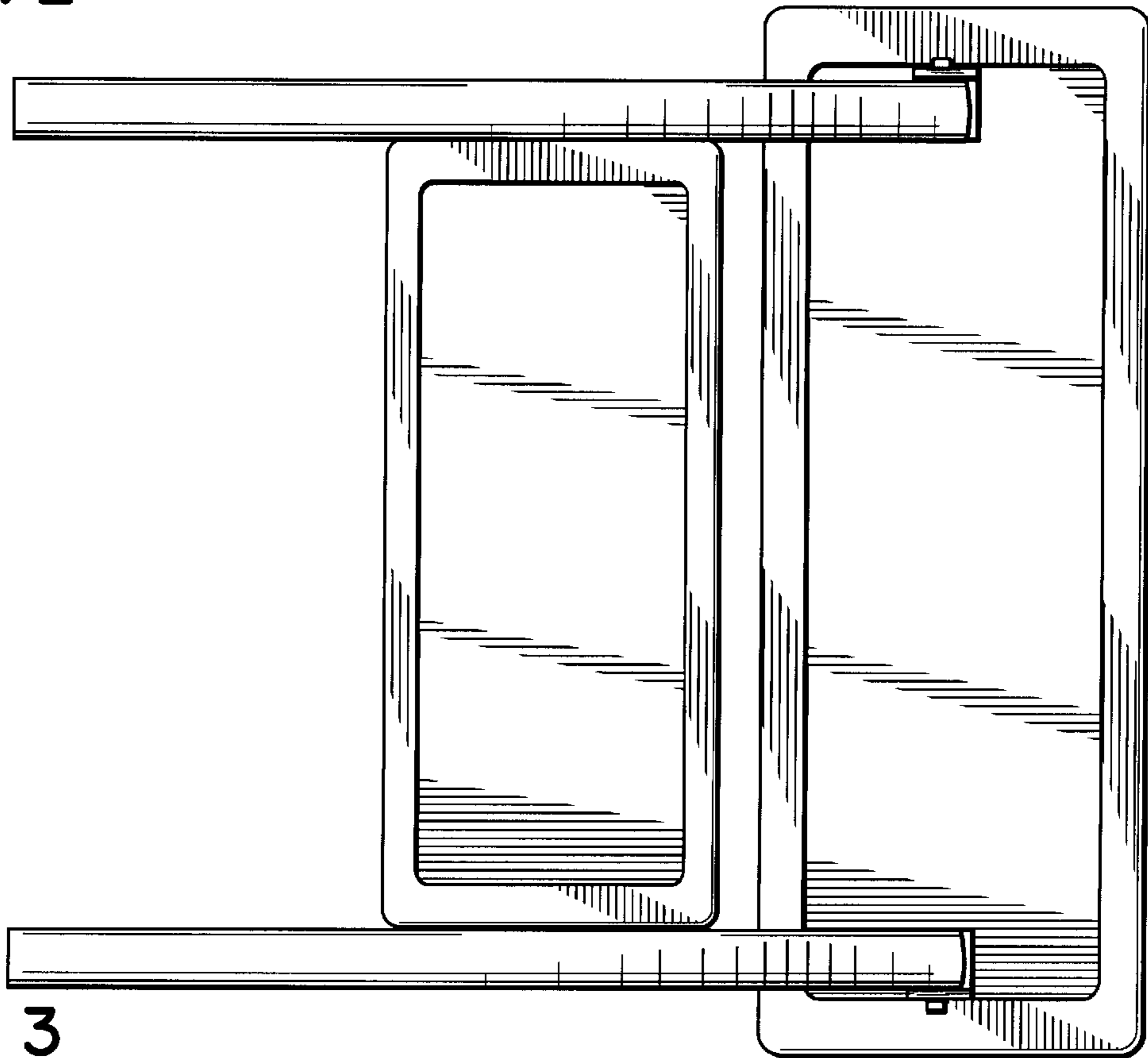

FIG. 3

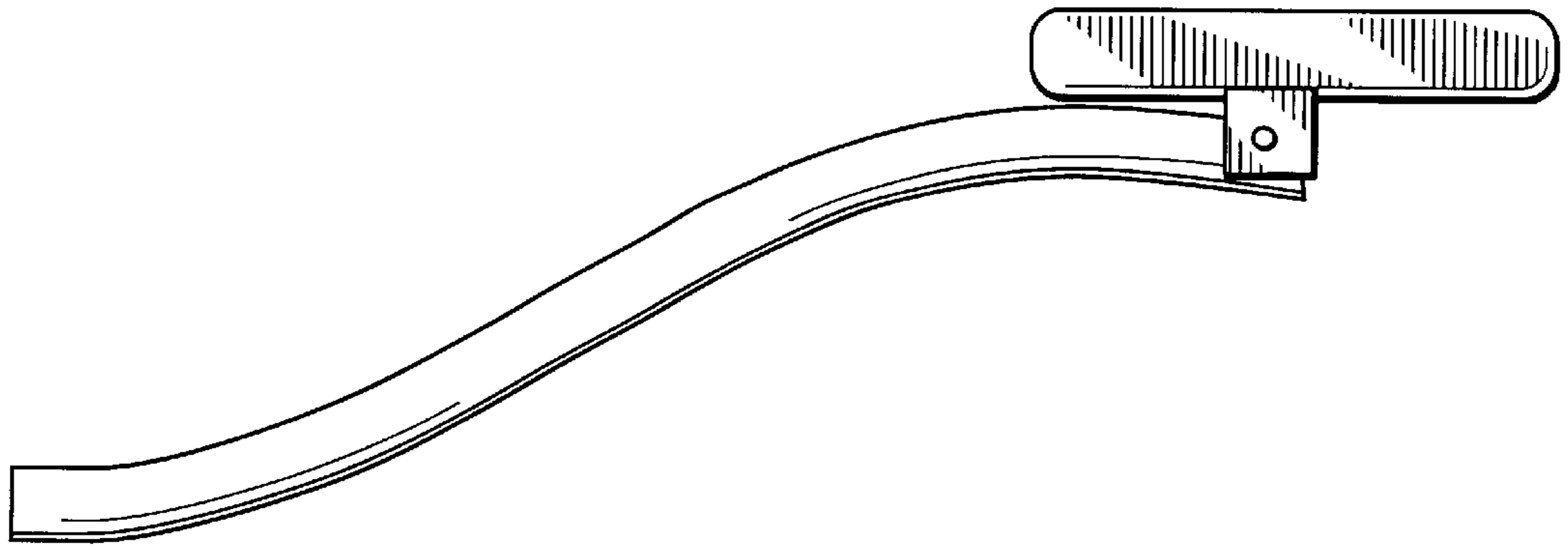

FIG. 4

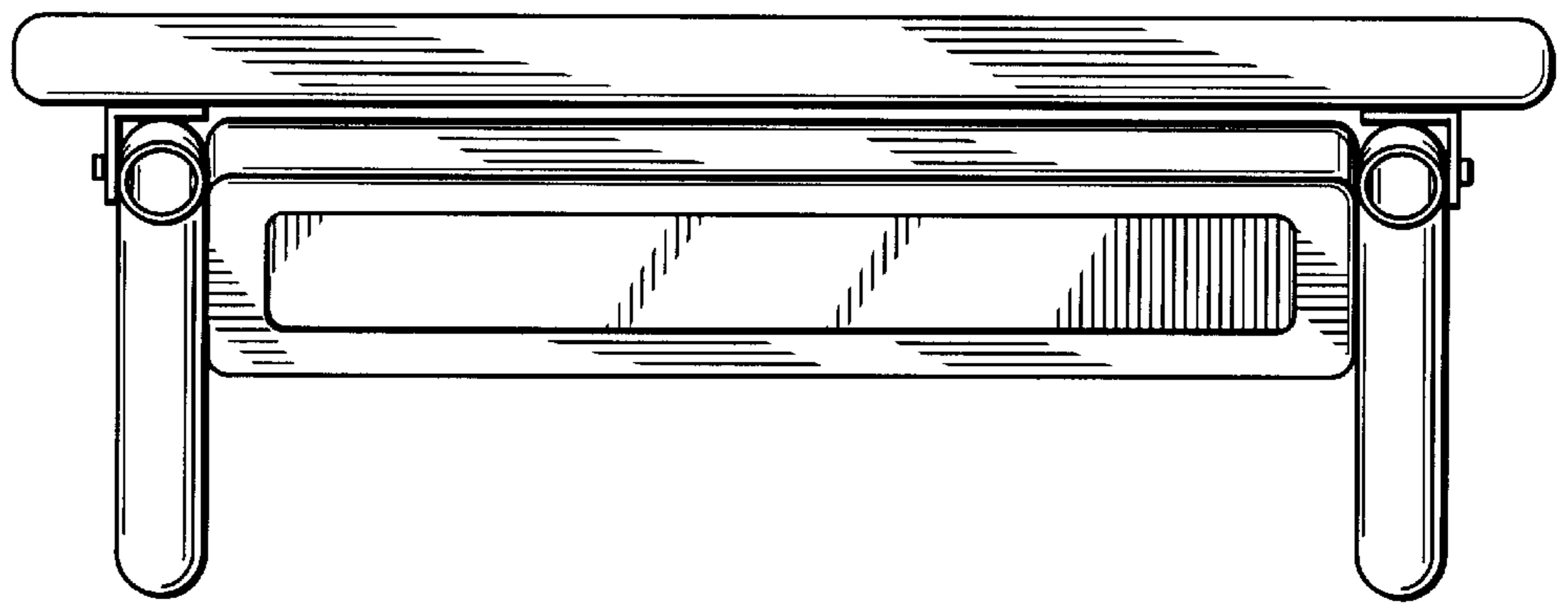

FIG. 5



FIG. 6

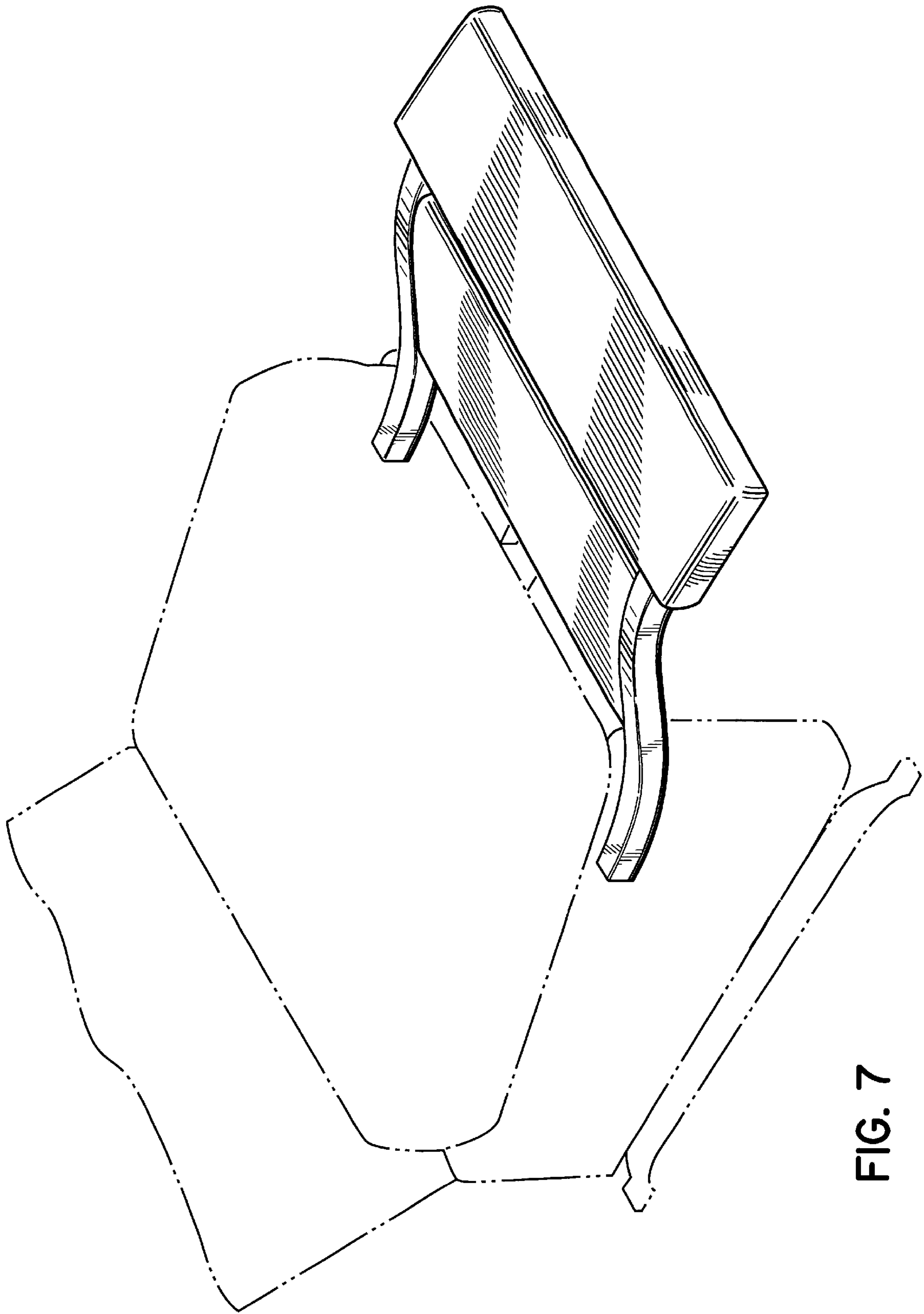

FIG. 7

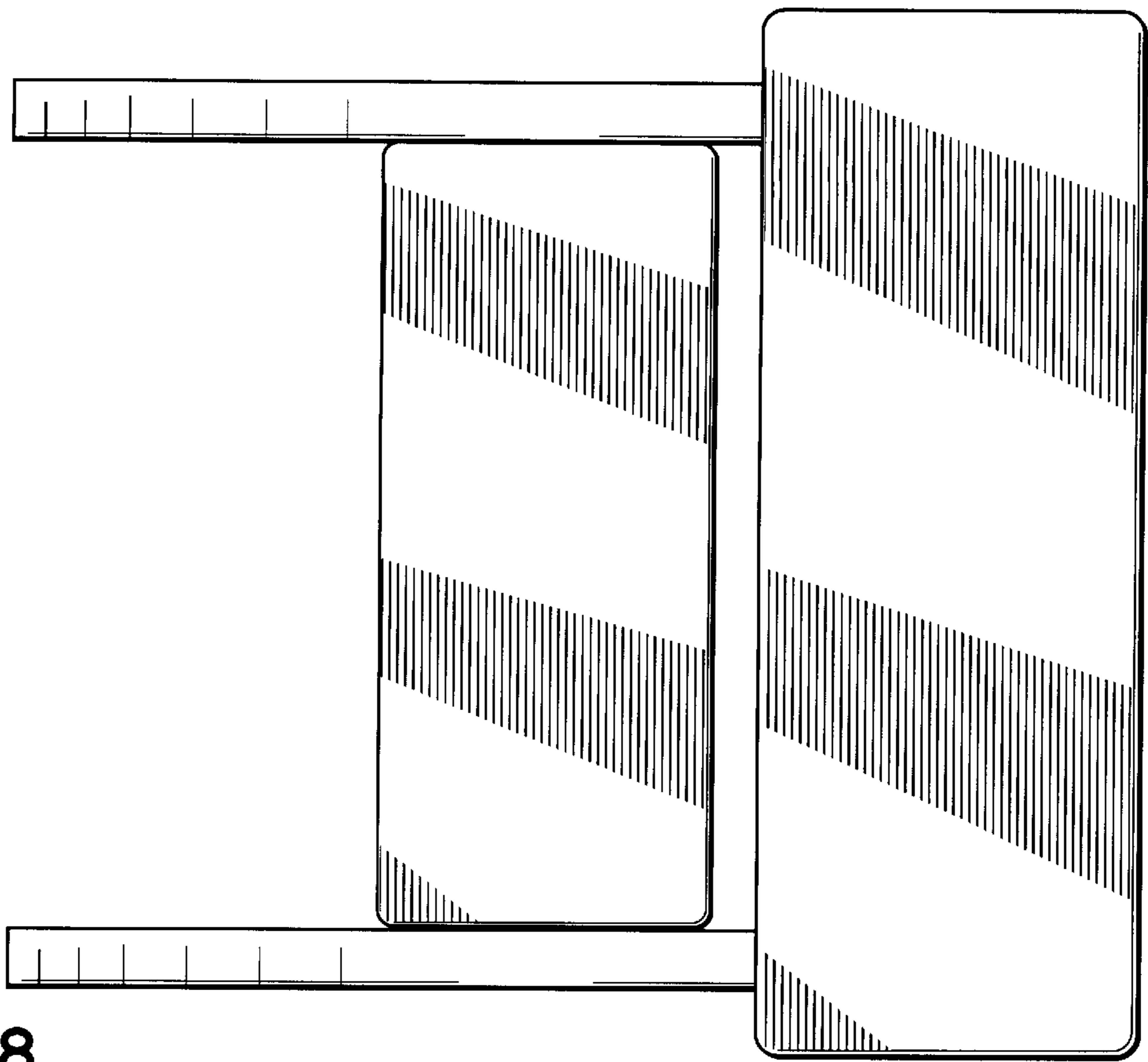

FIG. 8

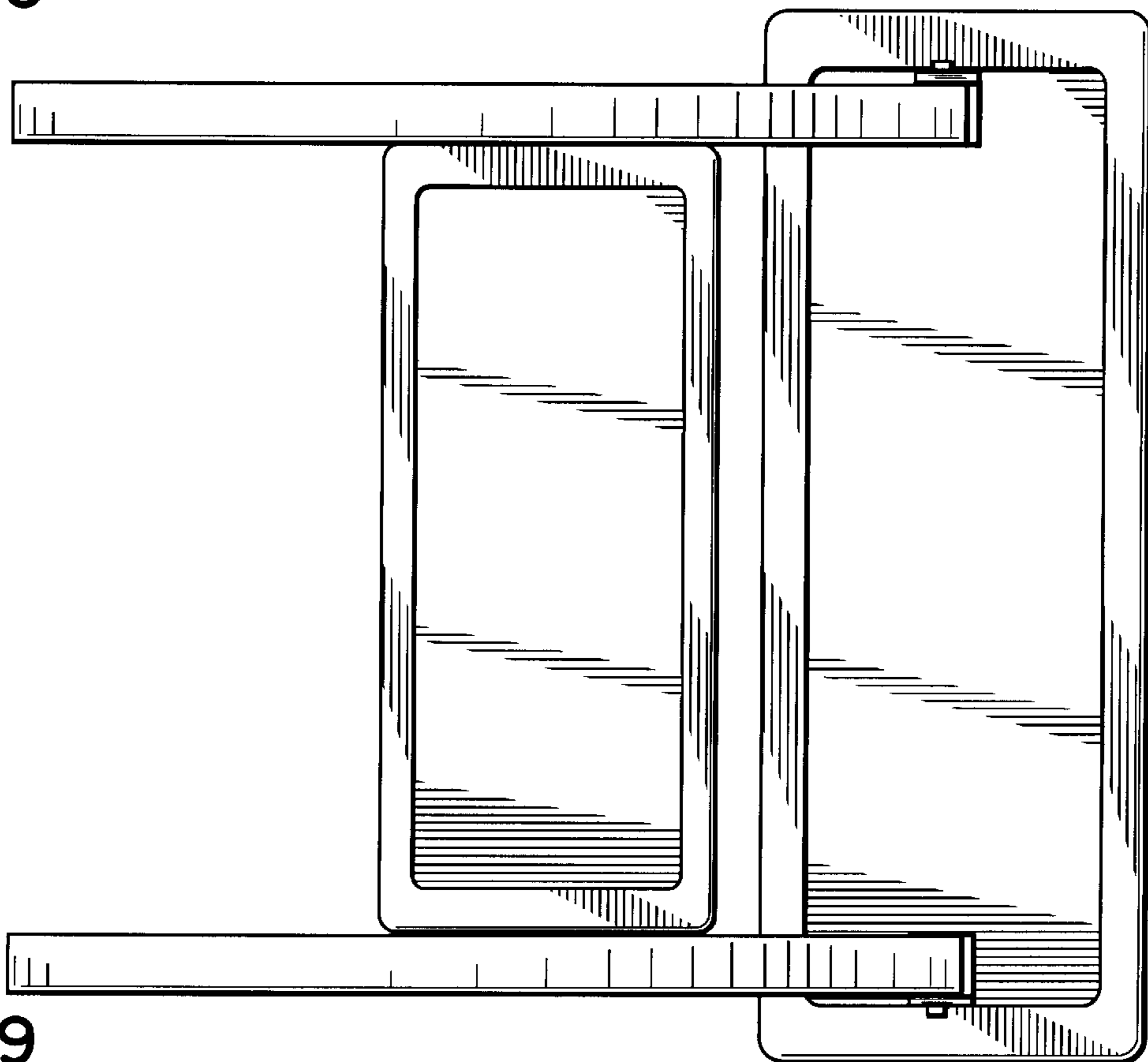

FIG. 9

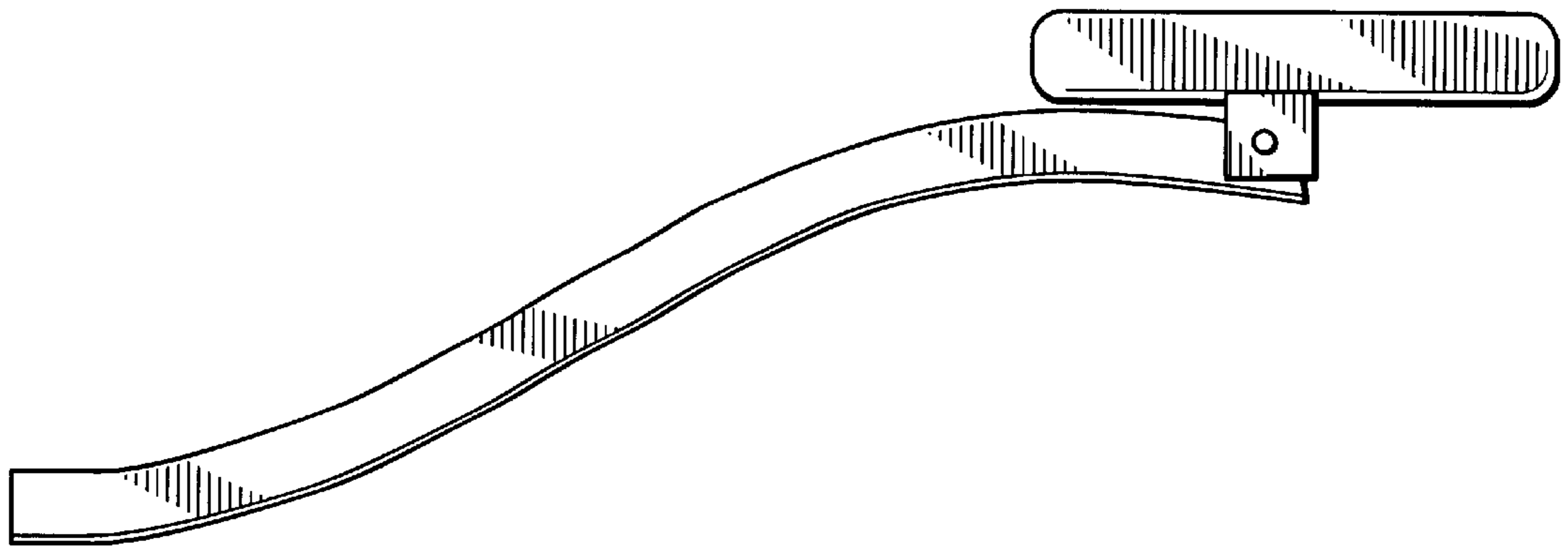

FIG. 10

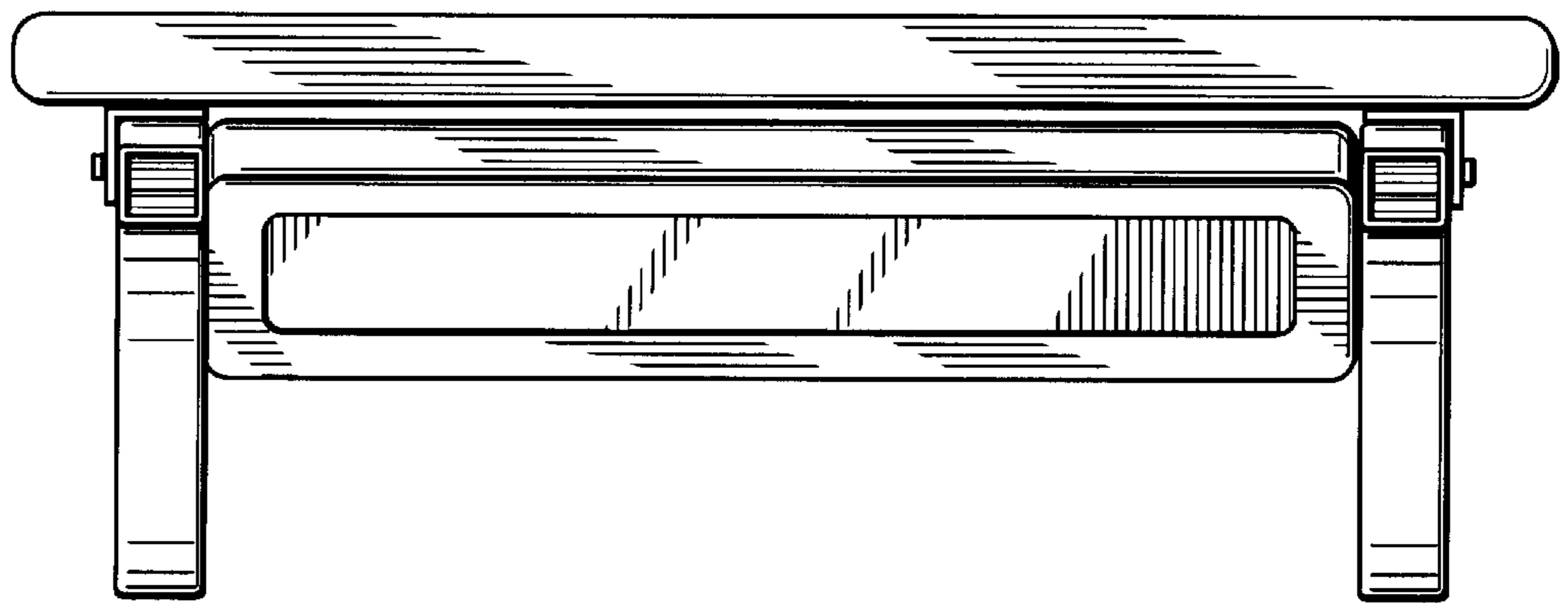

FIG. 11

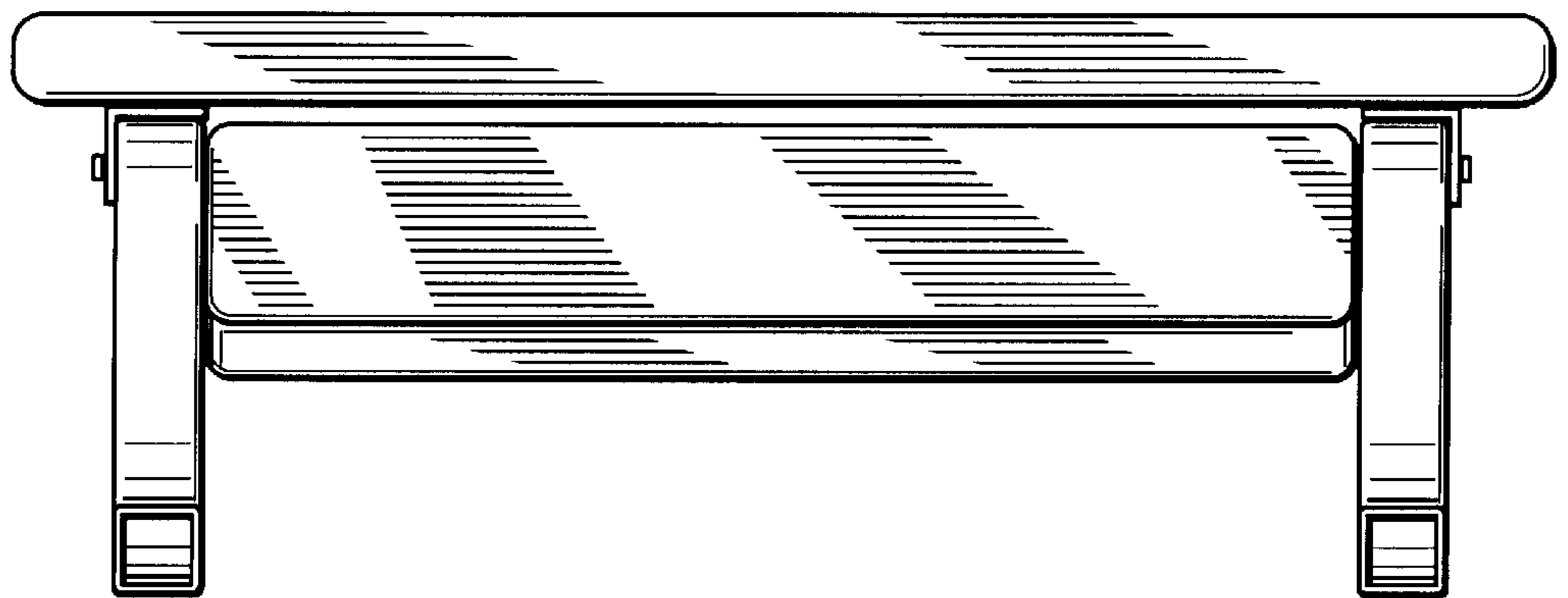

FIG. 12

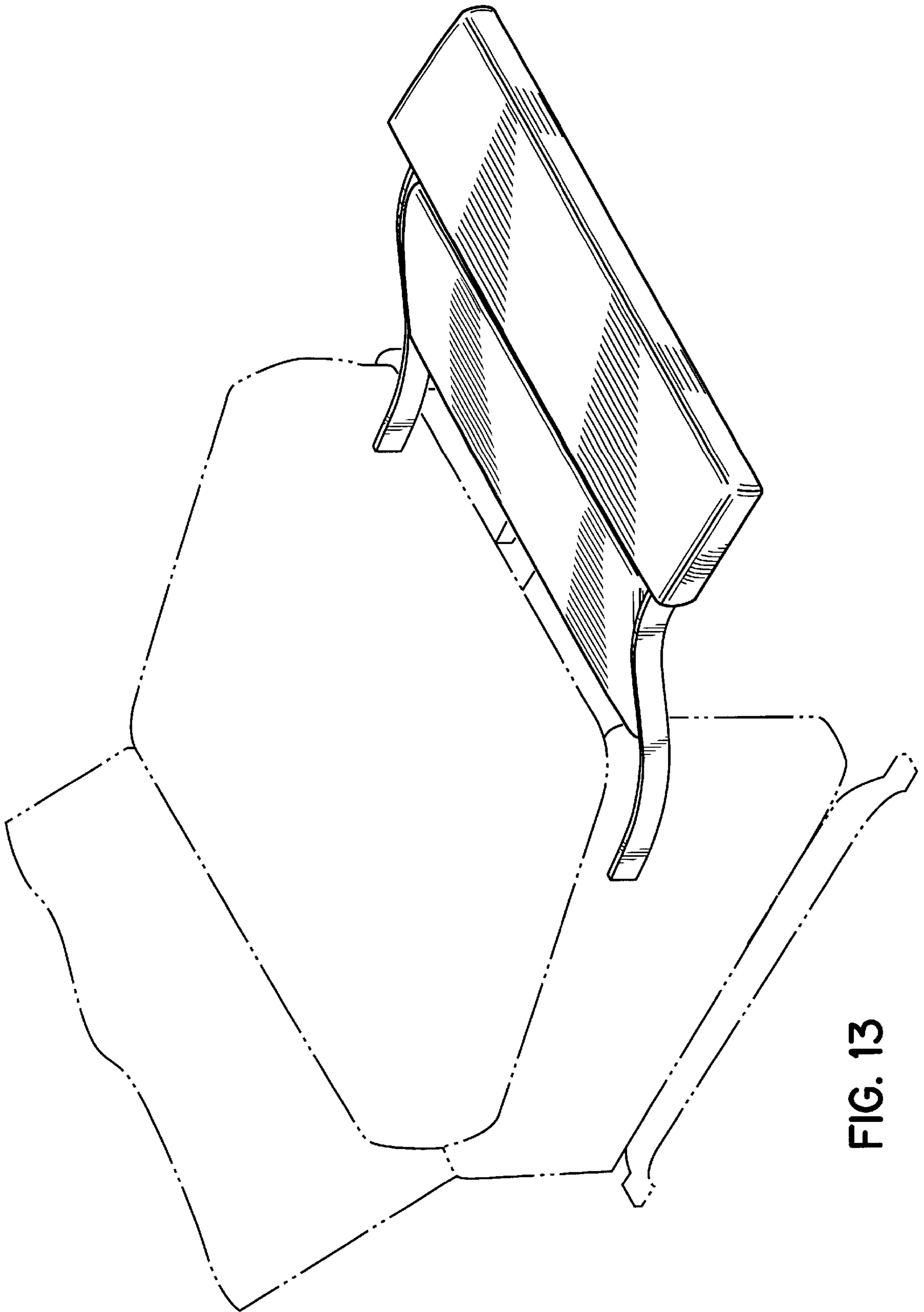

FIG. 13

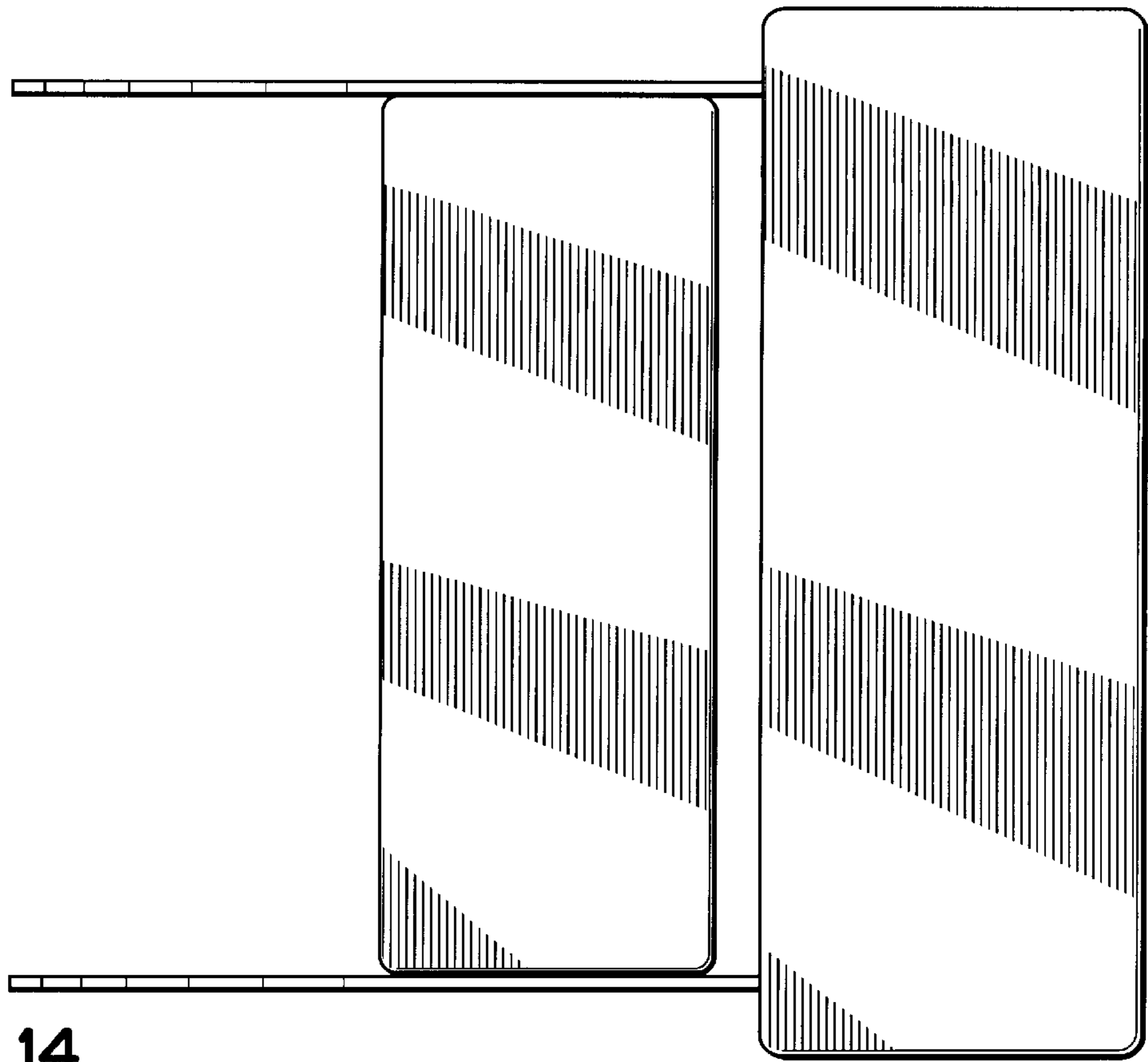

FIG. 14

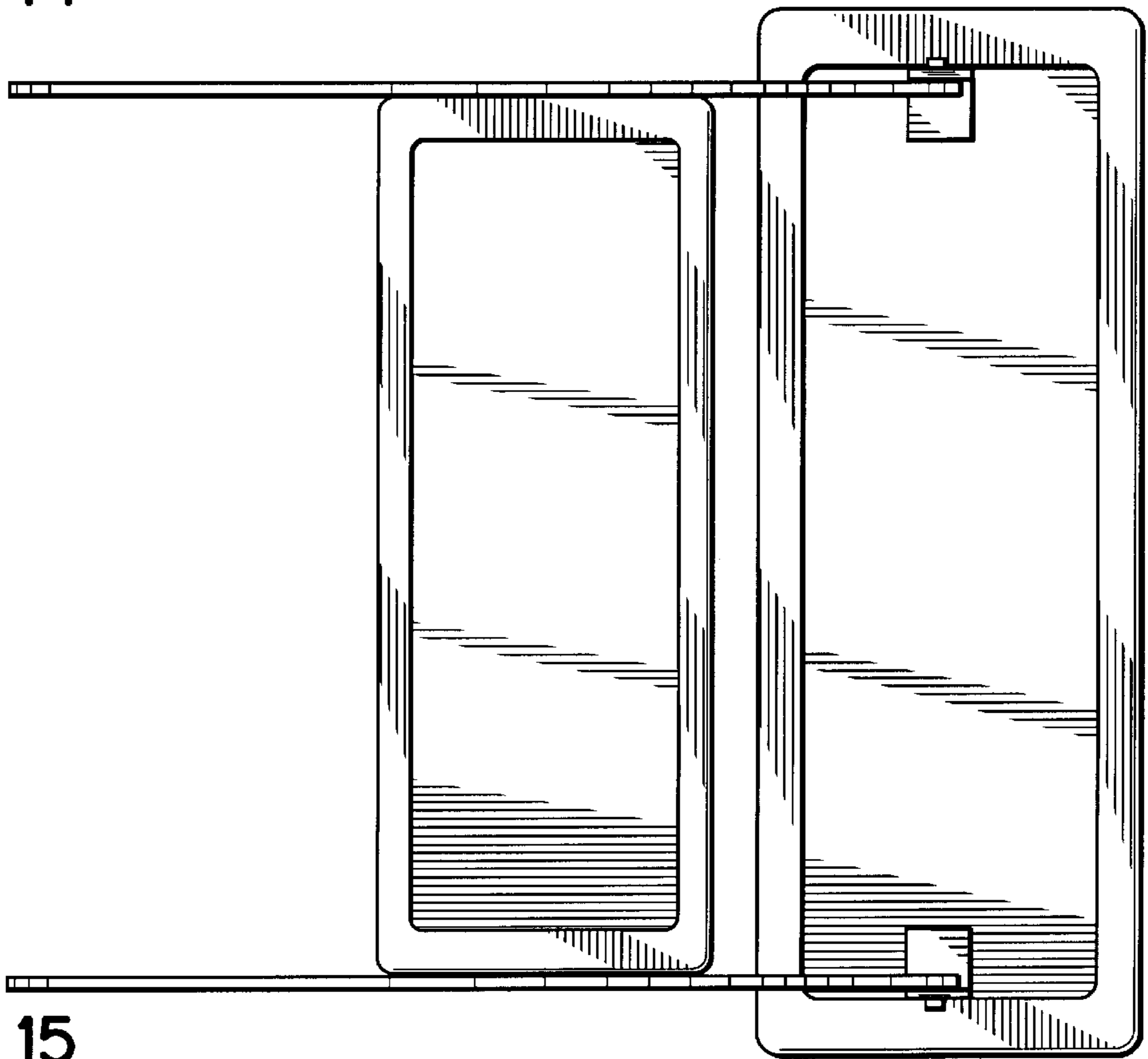

FIG. 15

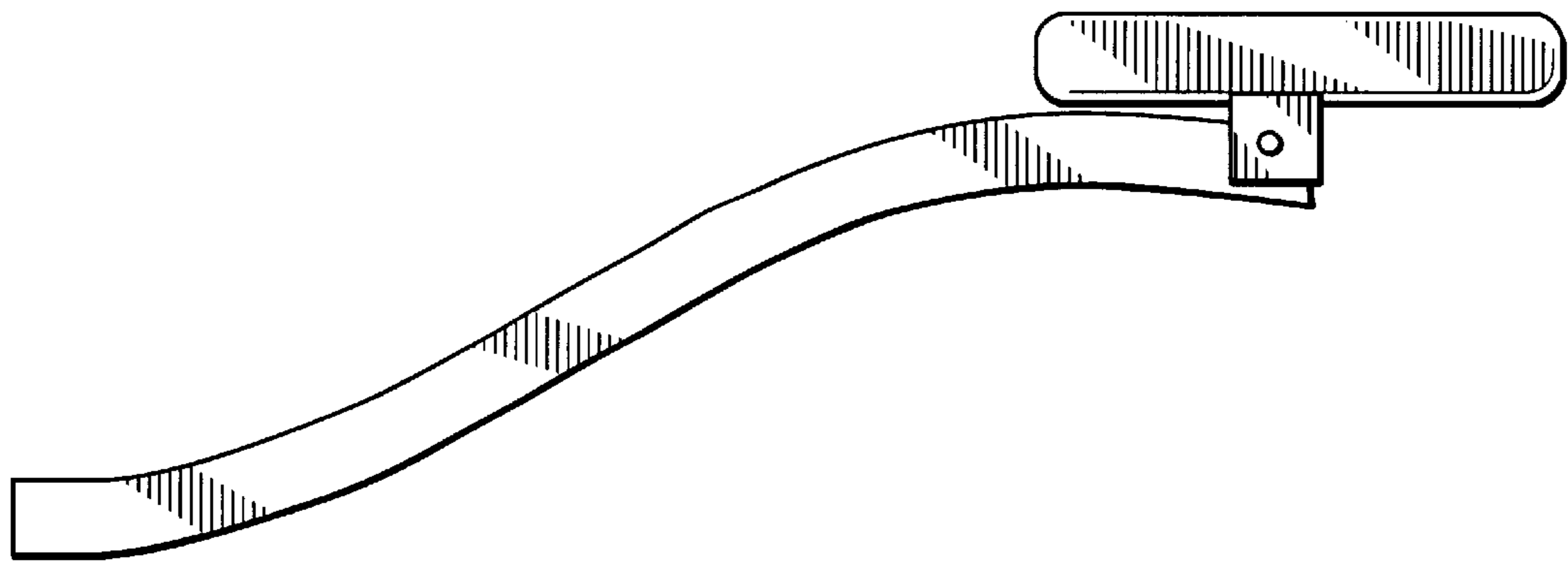

FIG. 16

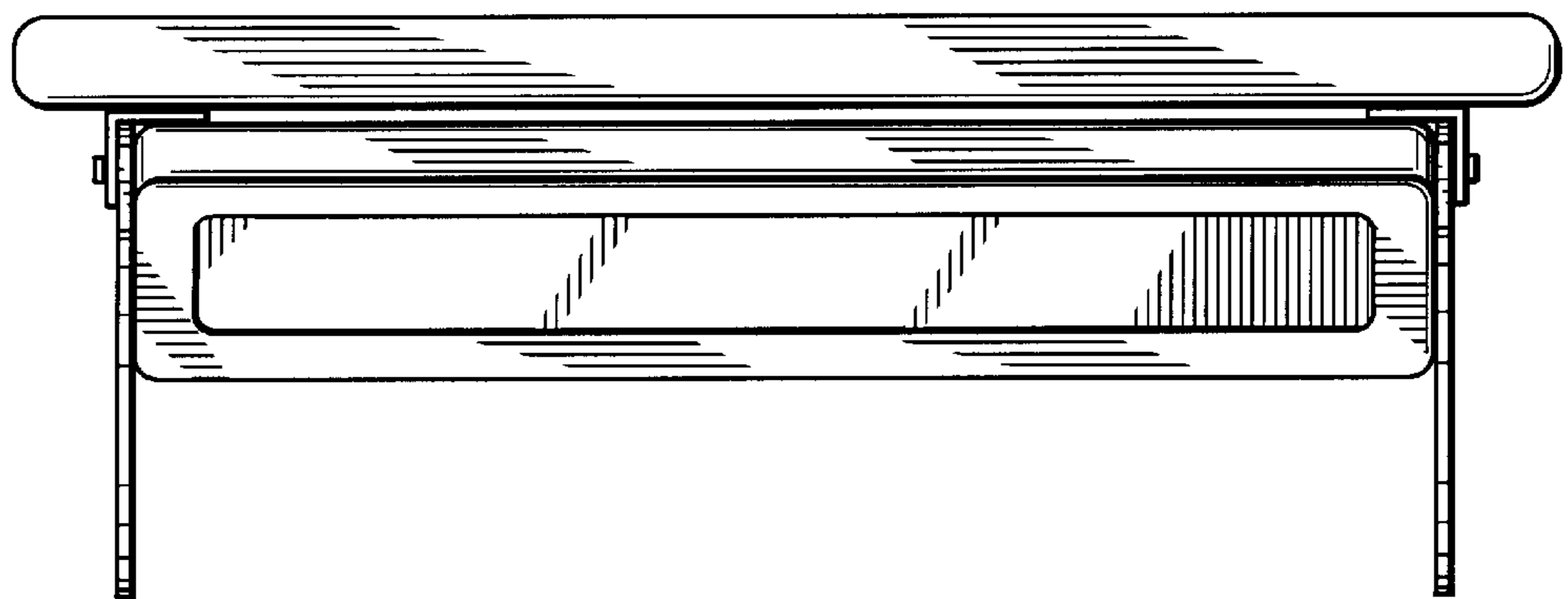

FIG. 17

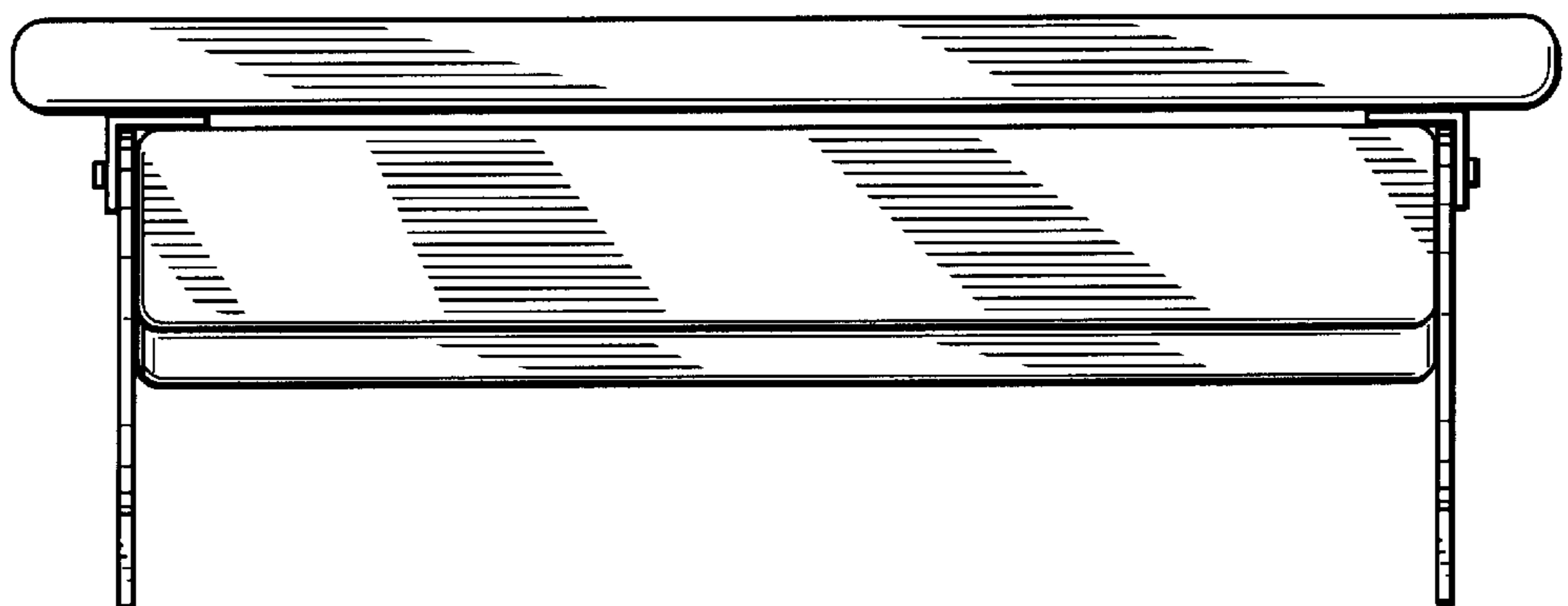

FIG. 18

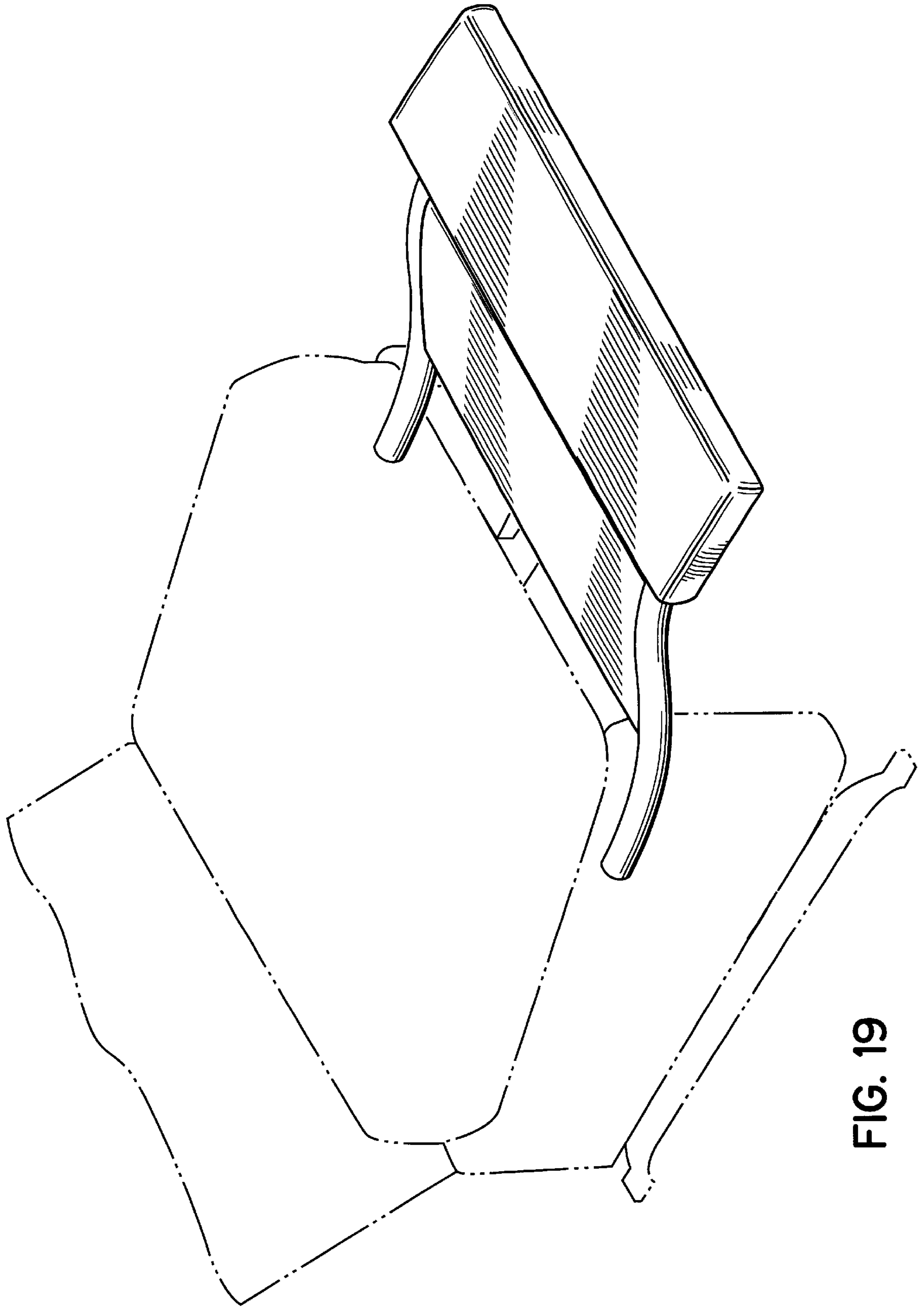

FIG. 19

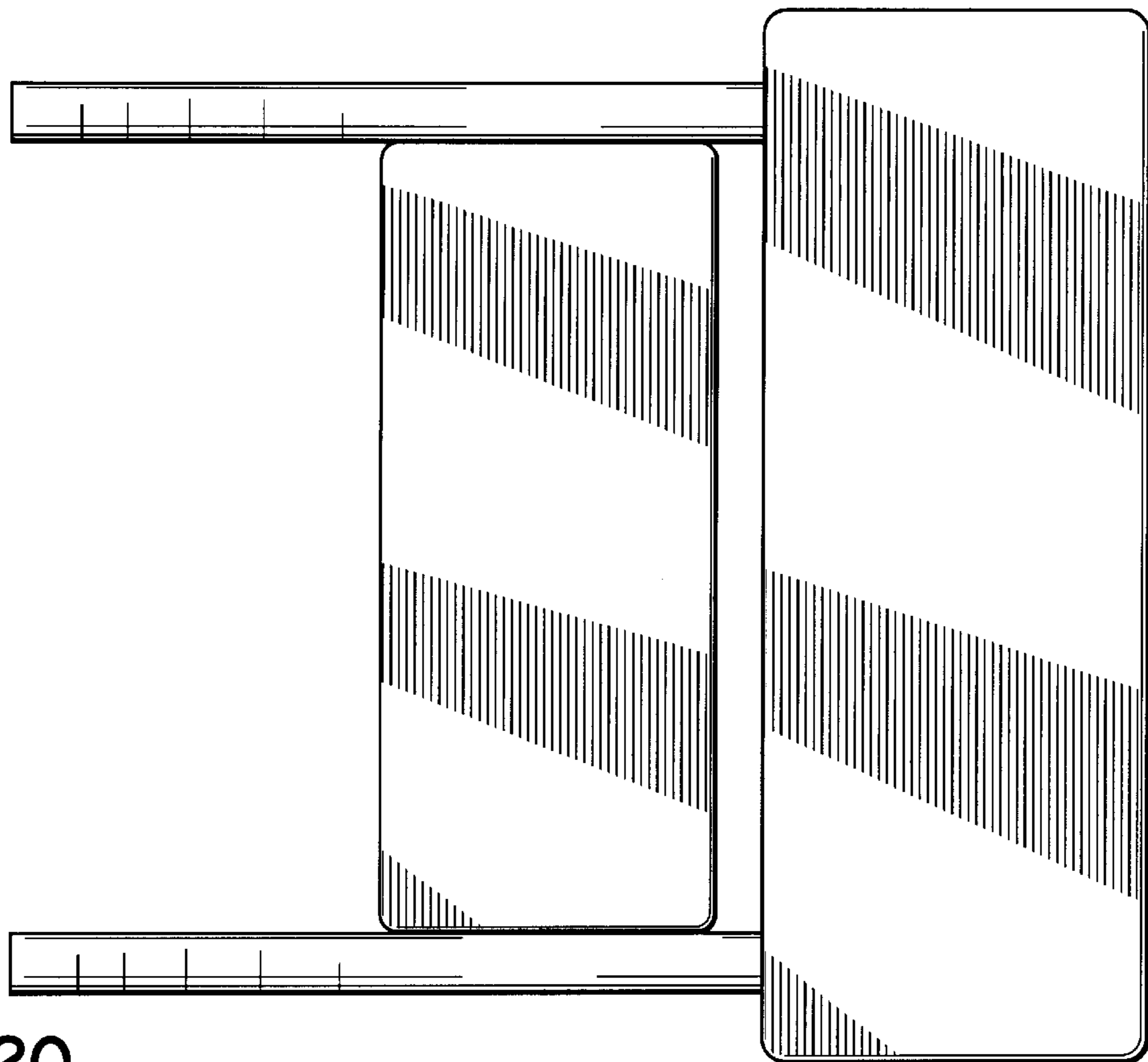

FIG. 20

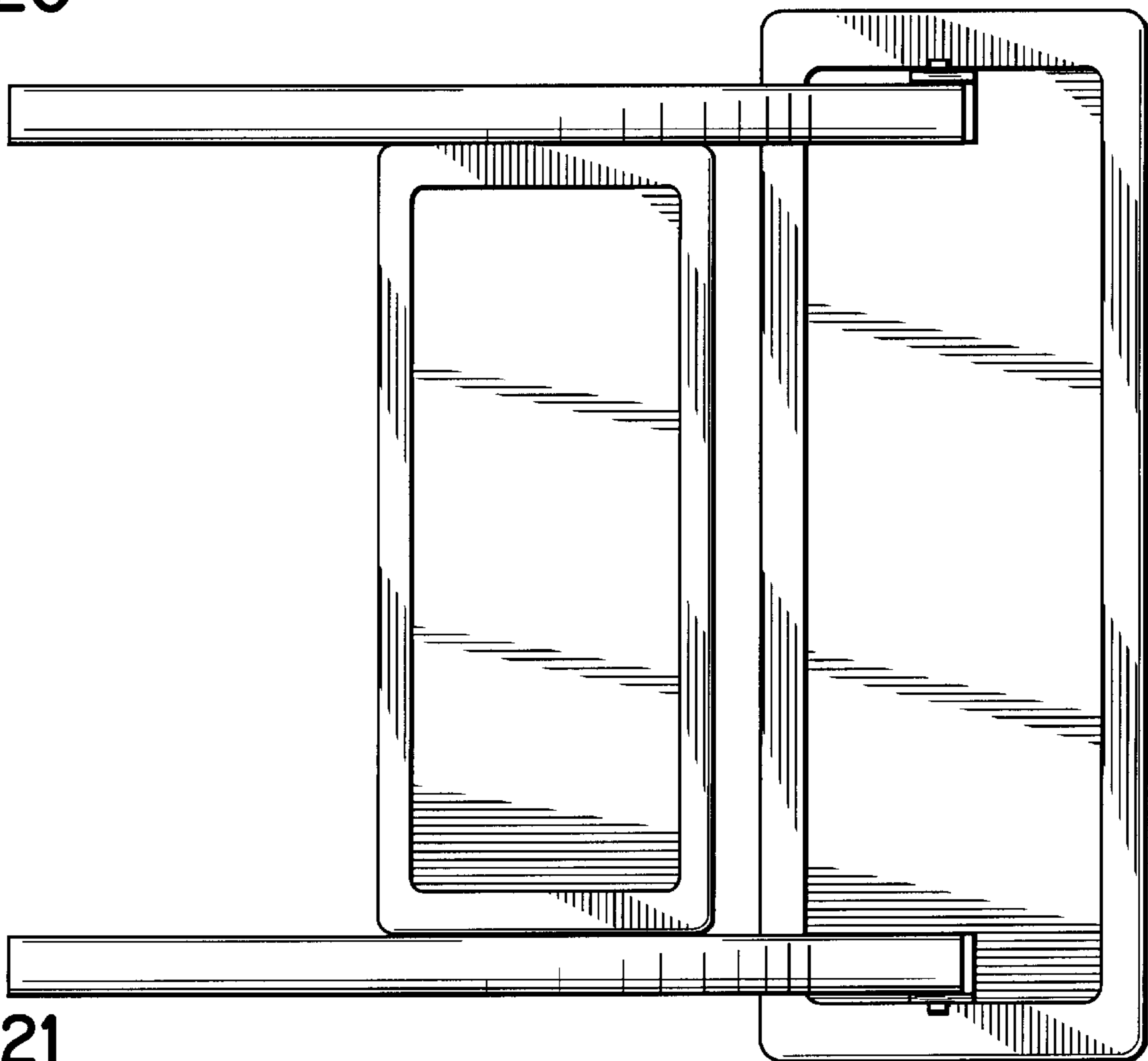

FIG. 21

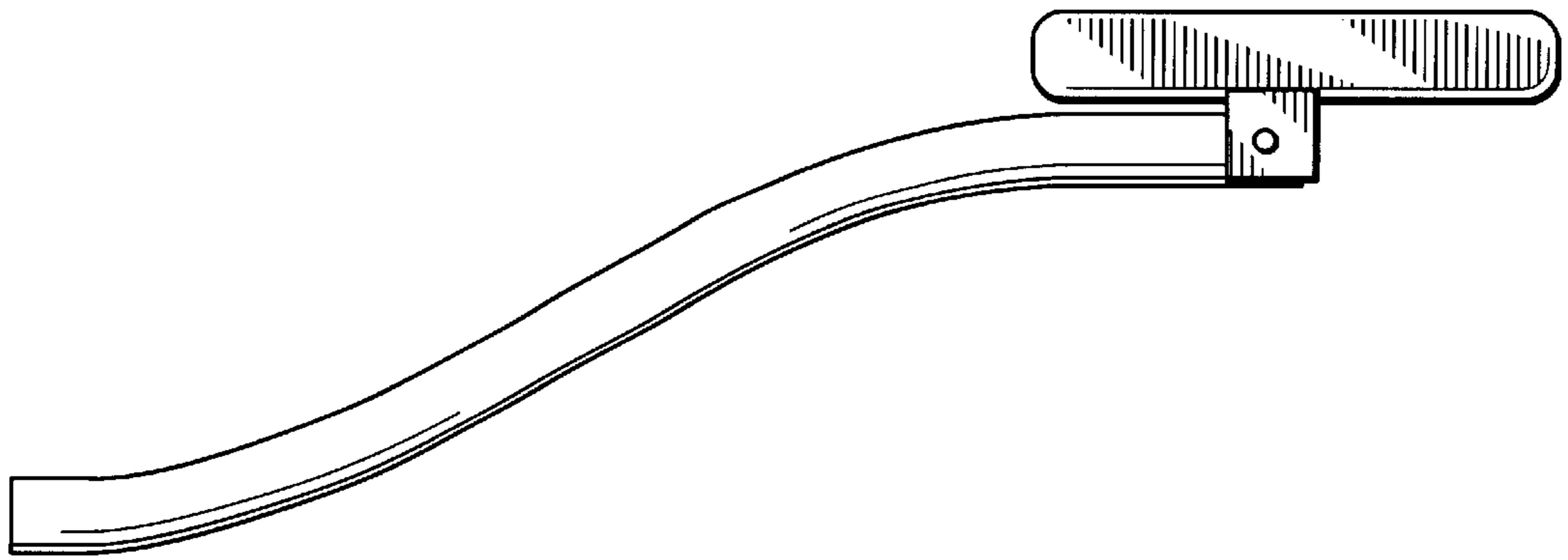

FIG. 22

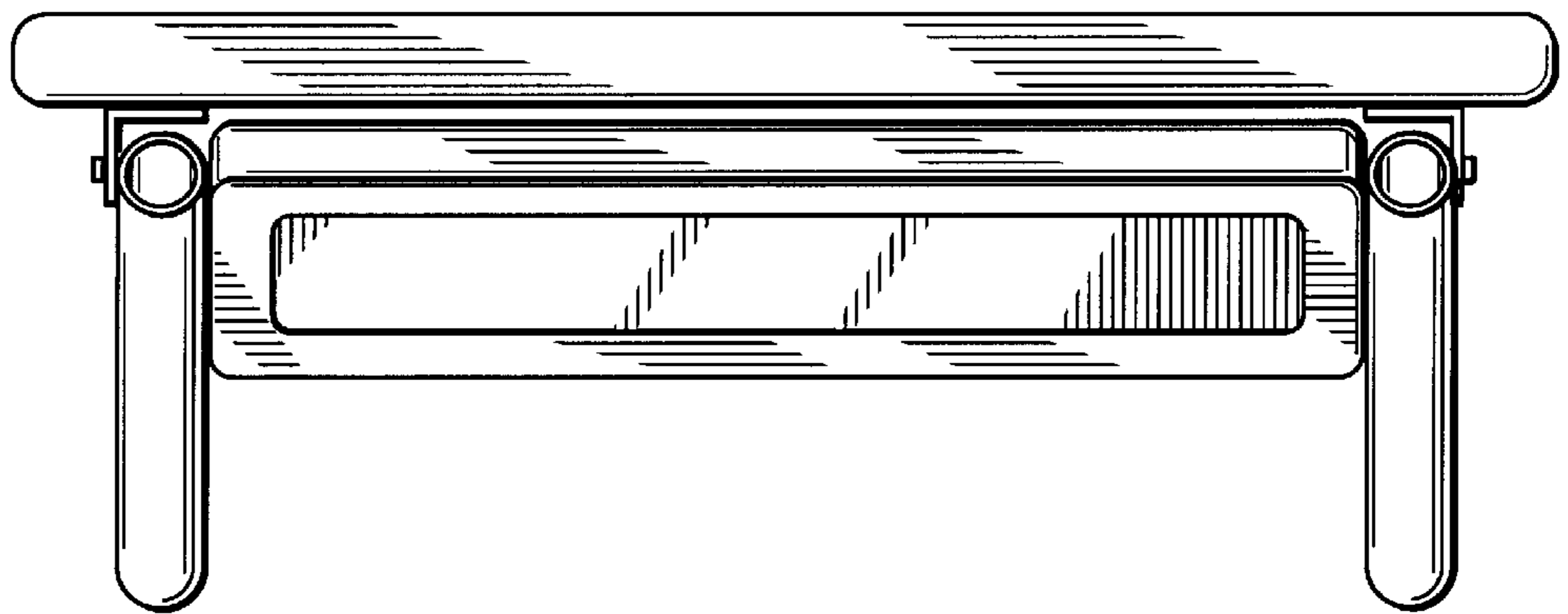

FIG. 23



FIG. 24

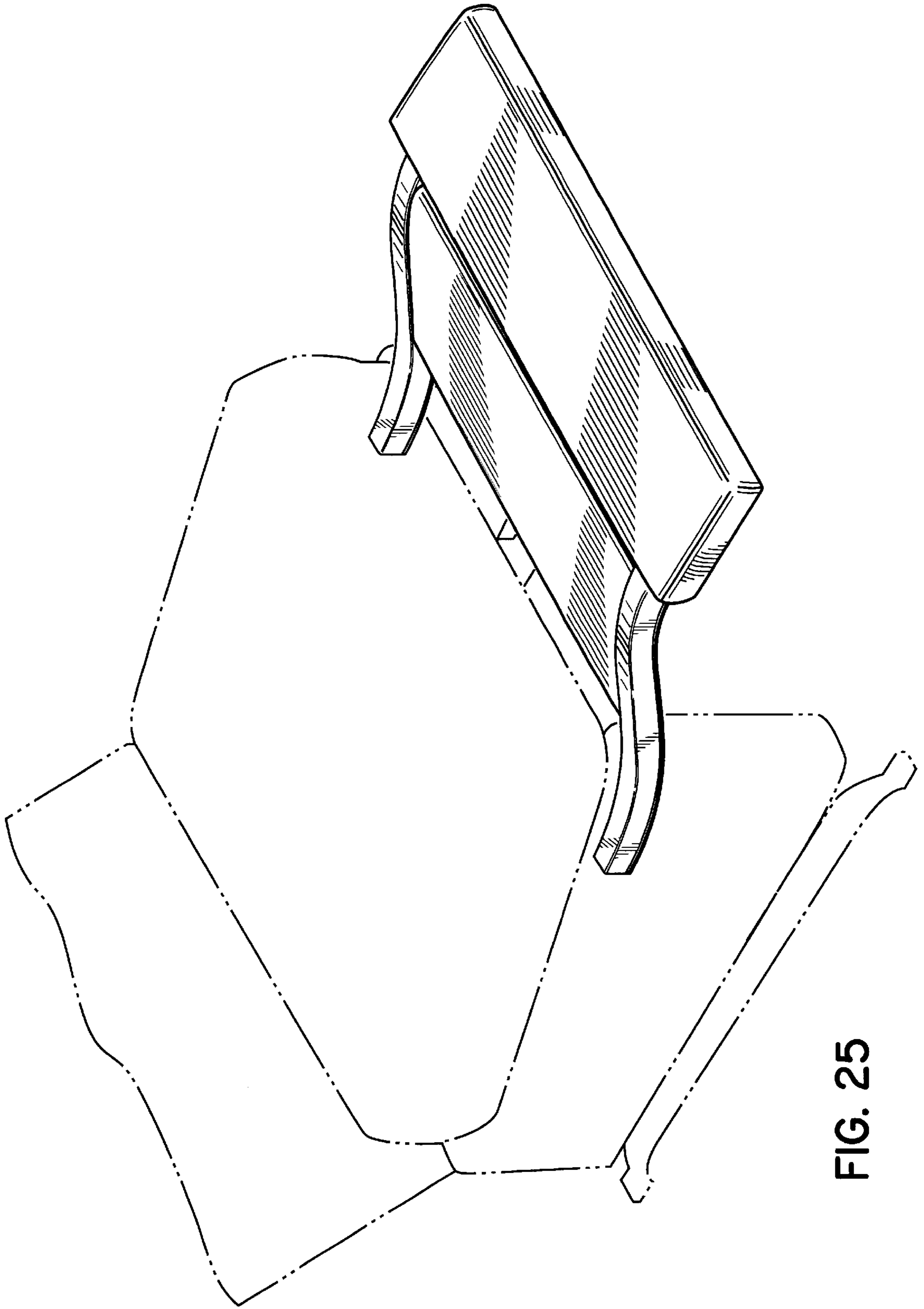

FIG. 25

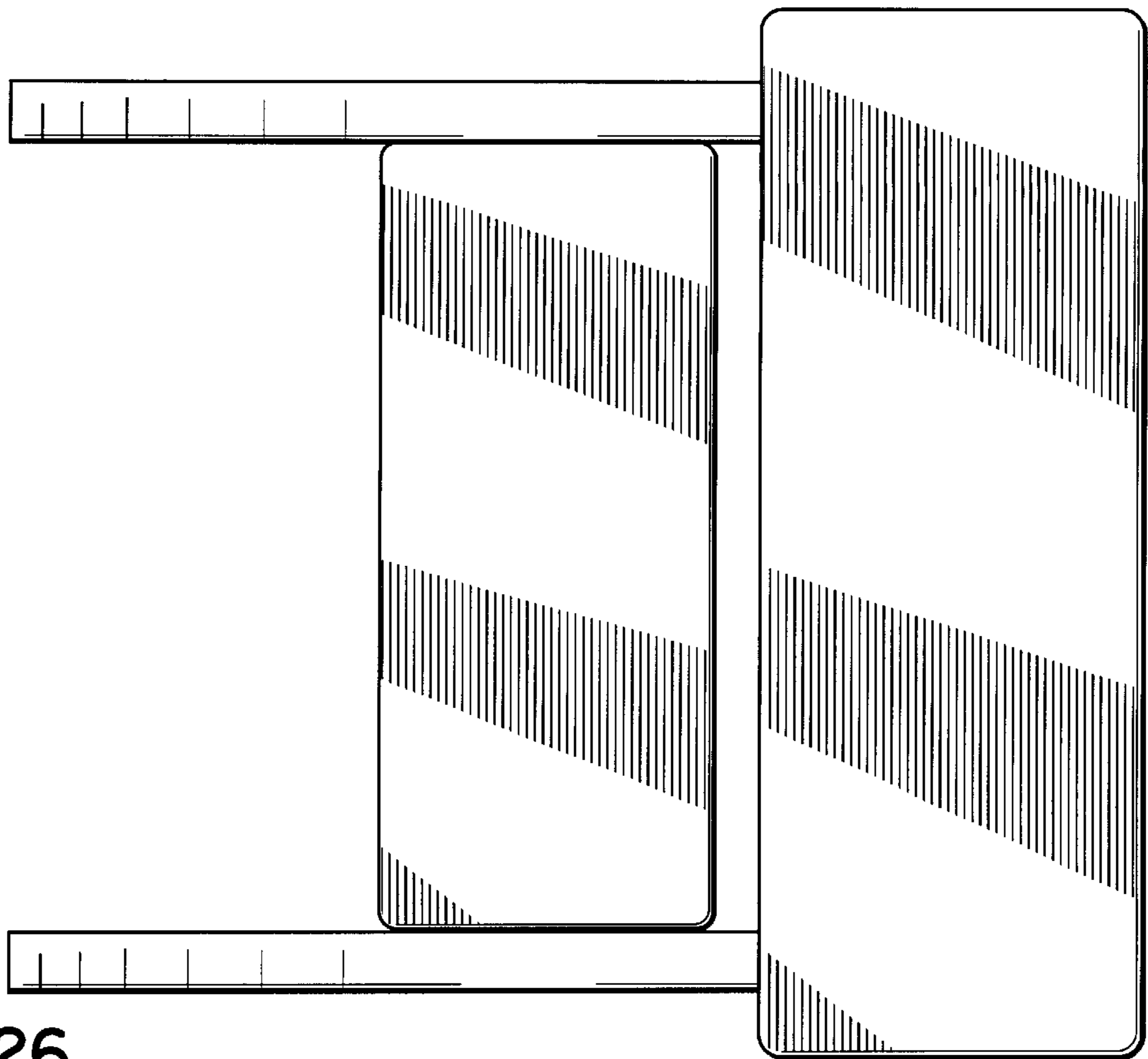

FIG. 26

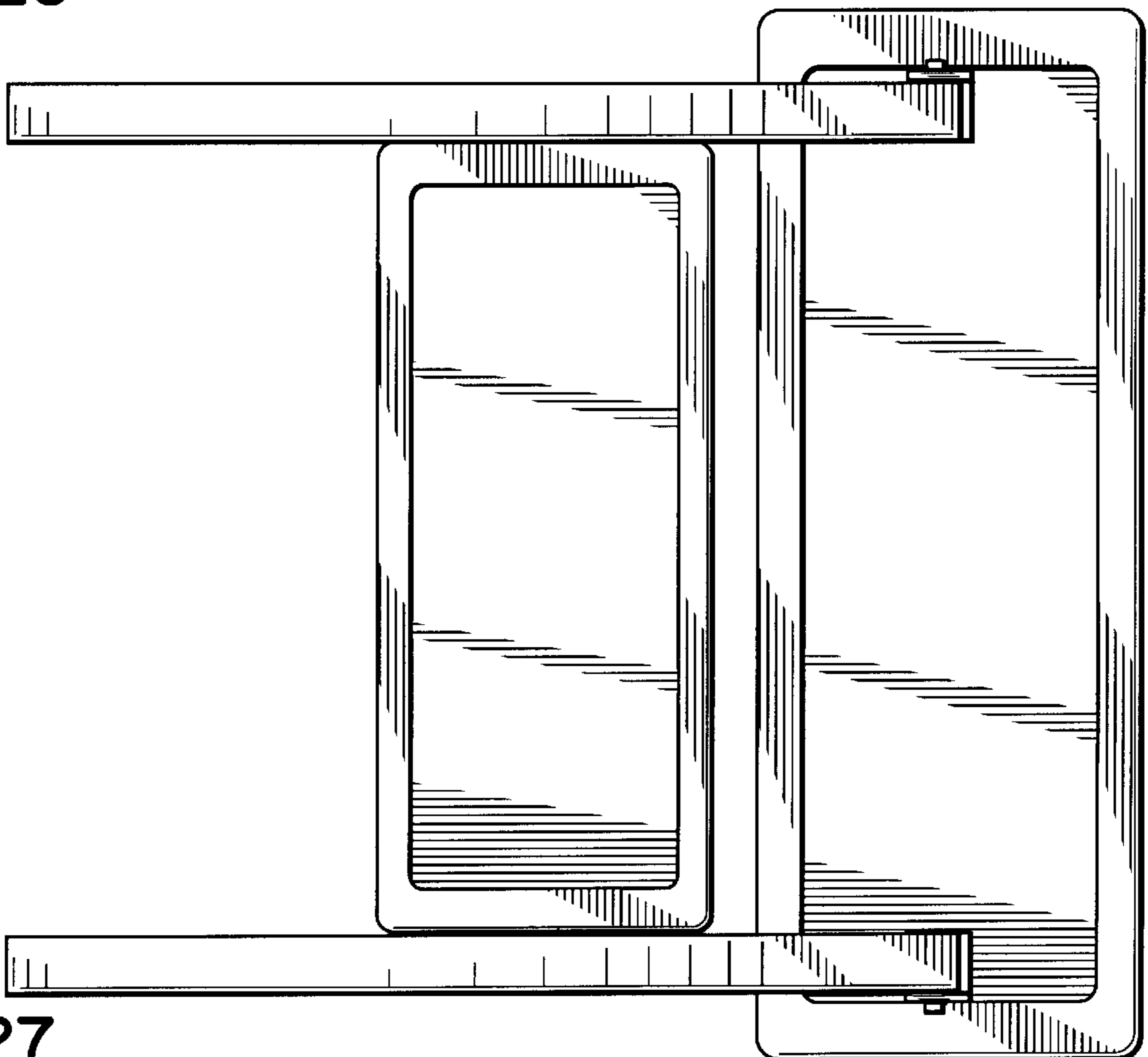

FIG. 27

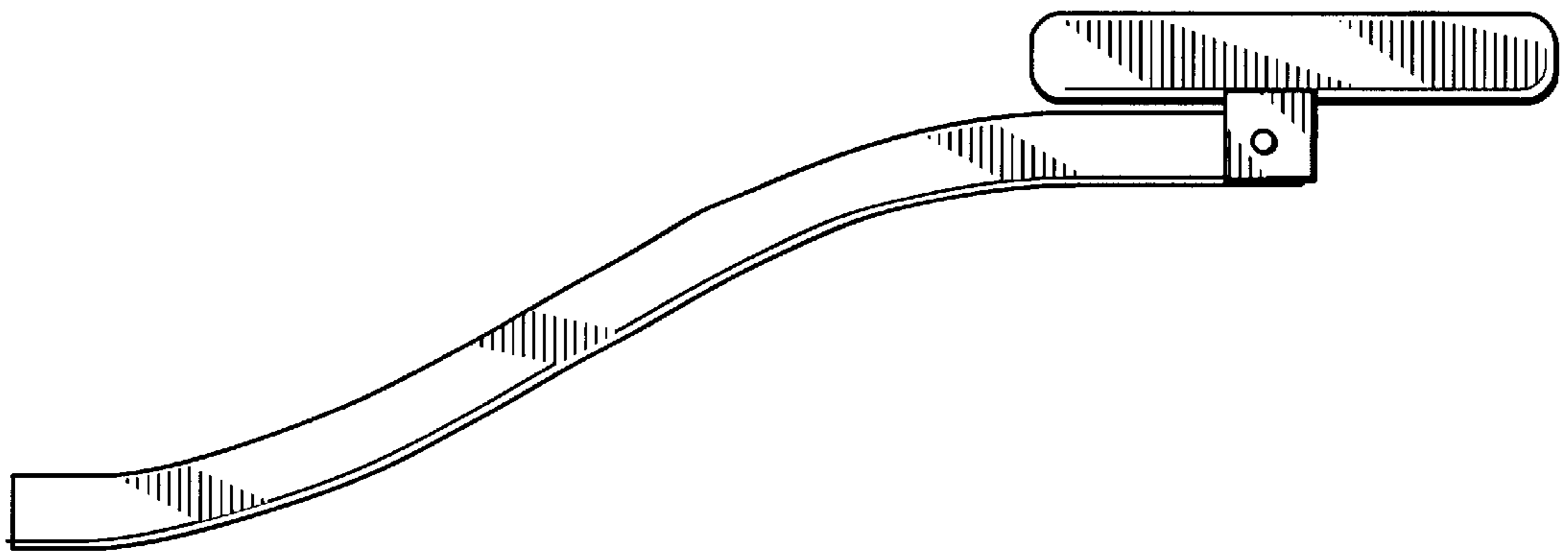

FIG. 28

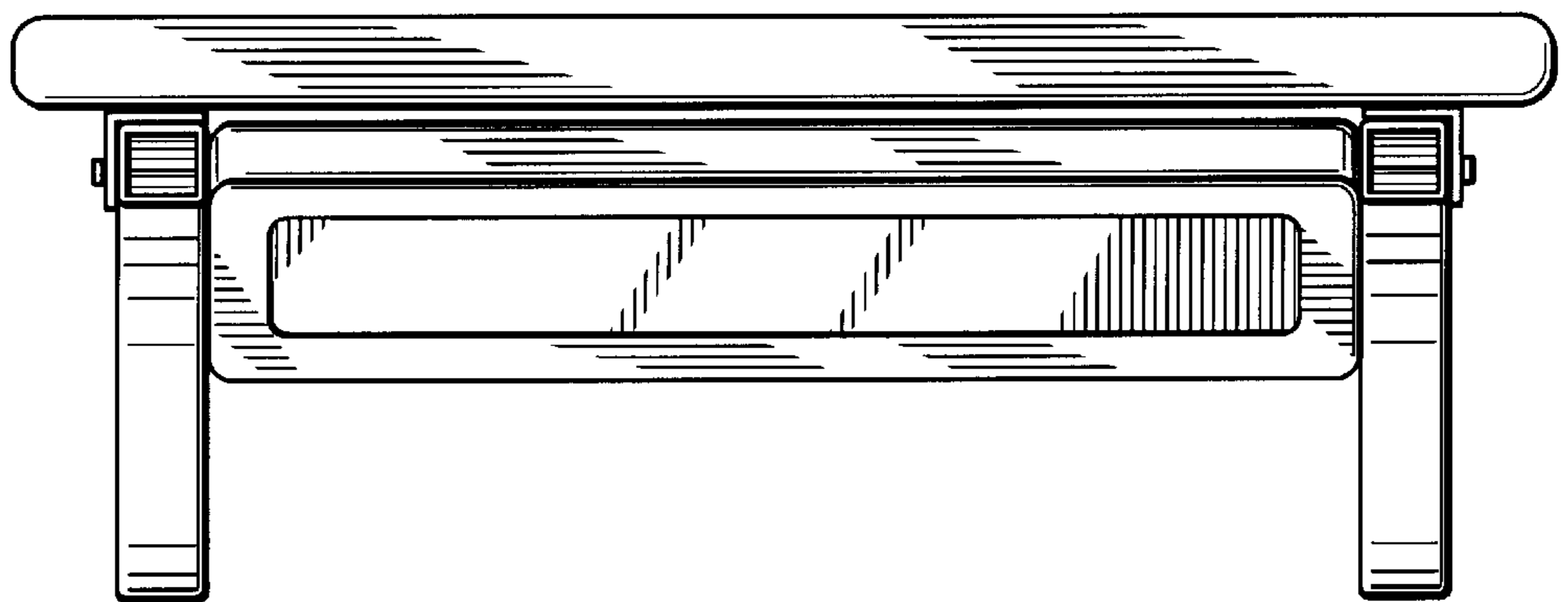

FIG. 29

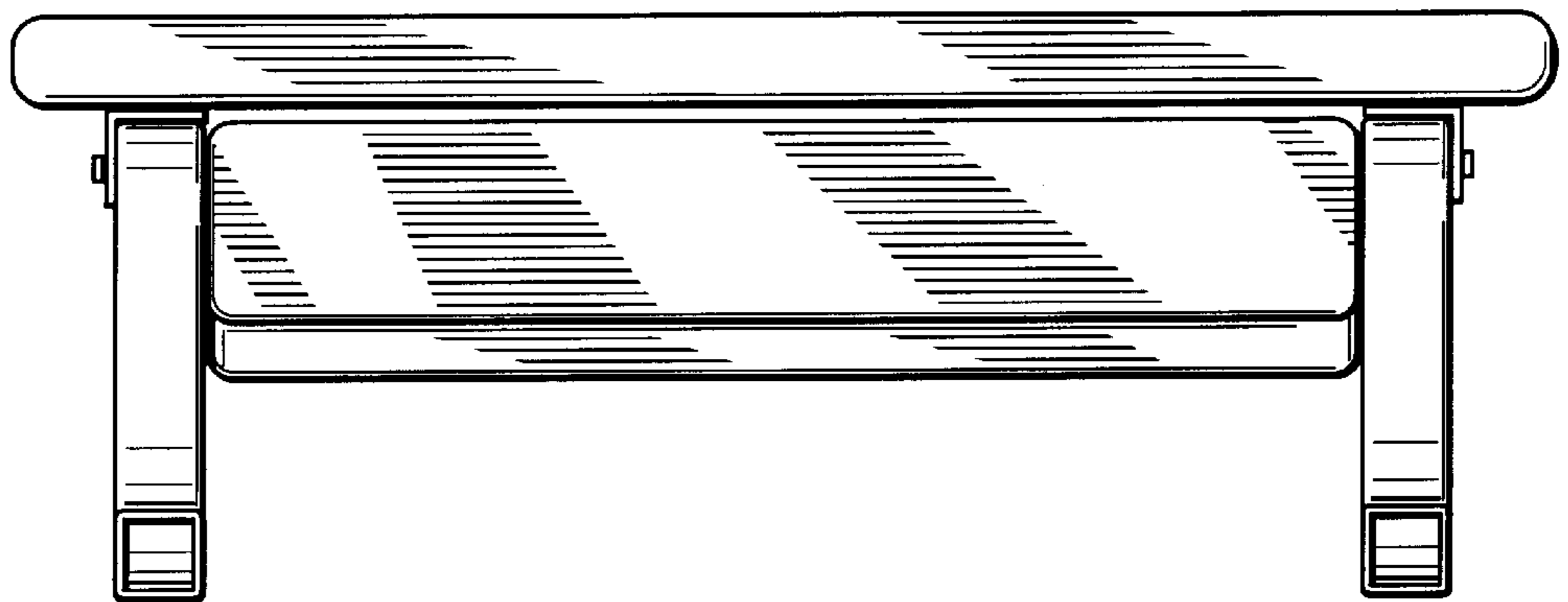

FIG. 30

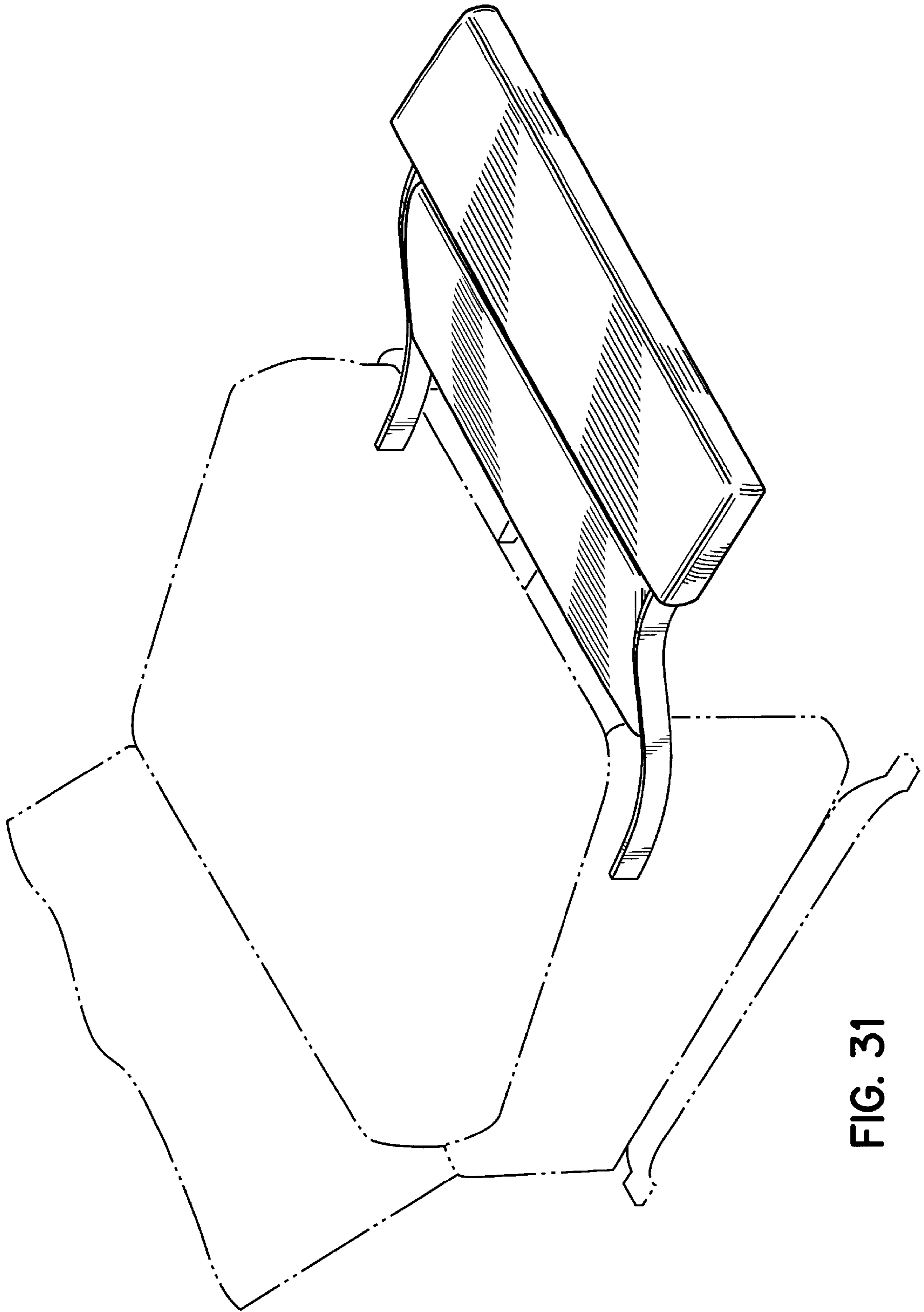

FIG. 31

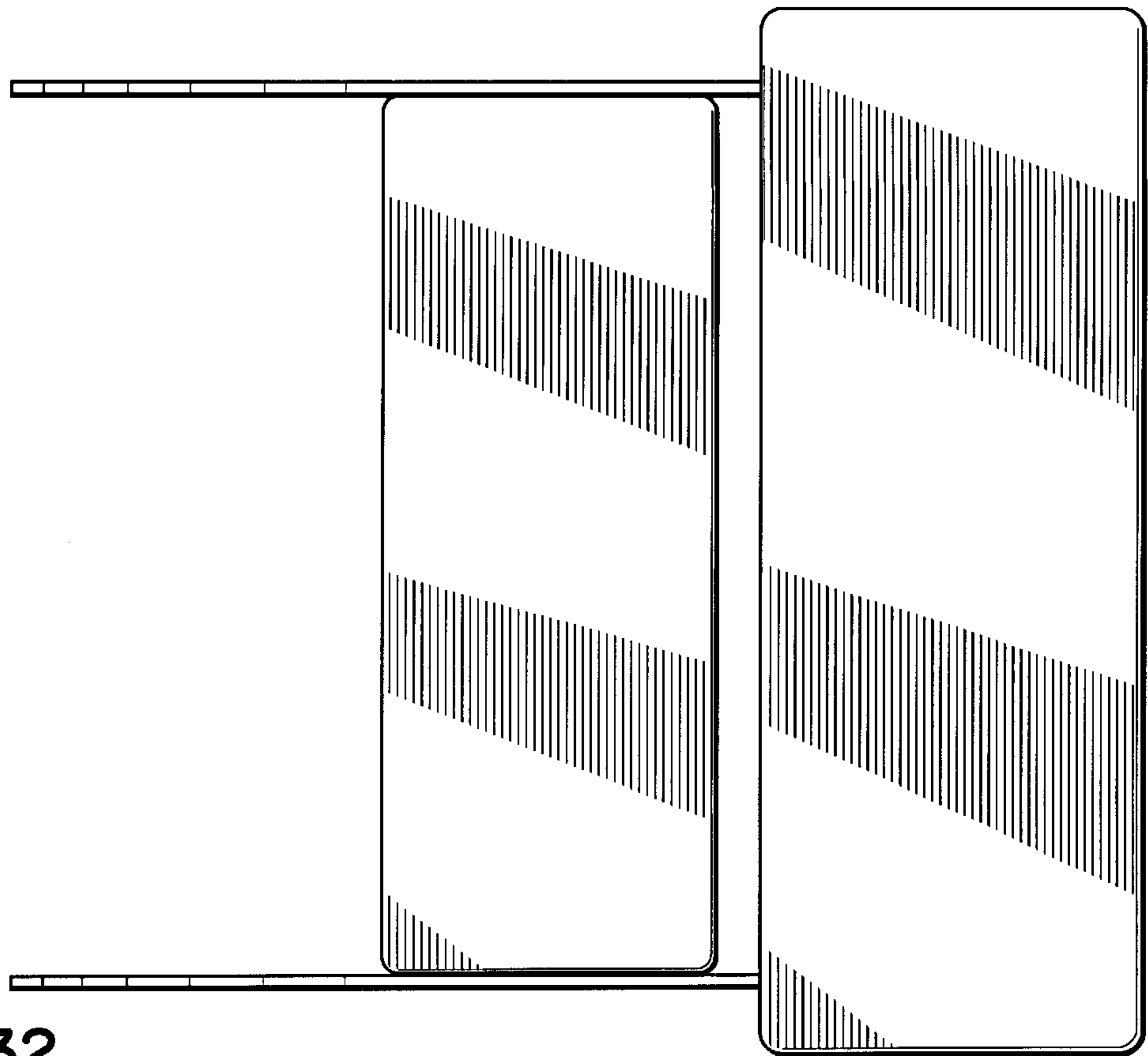

FIG. 32

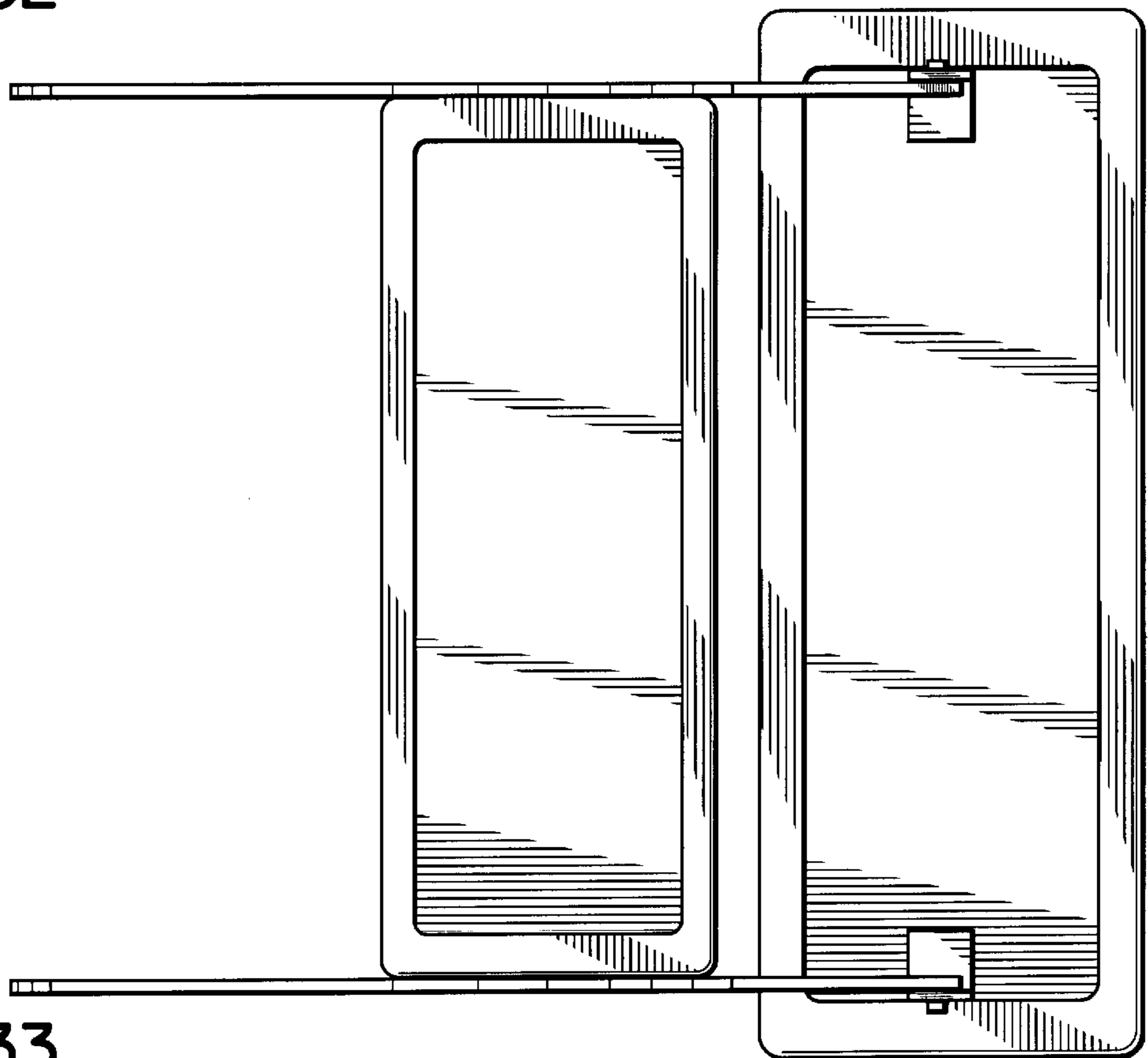

FIG. 33

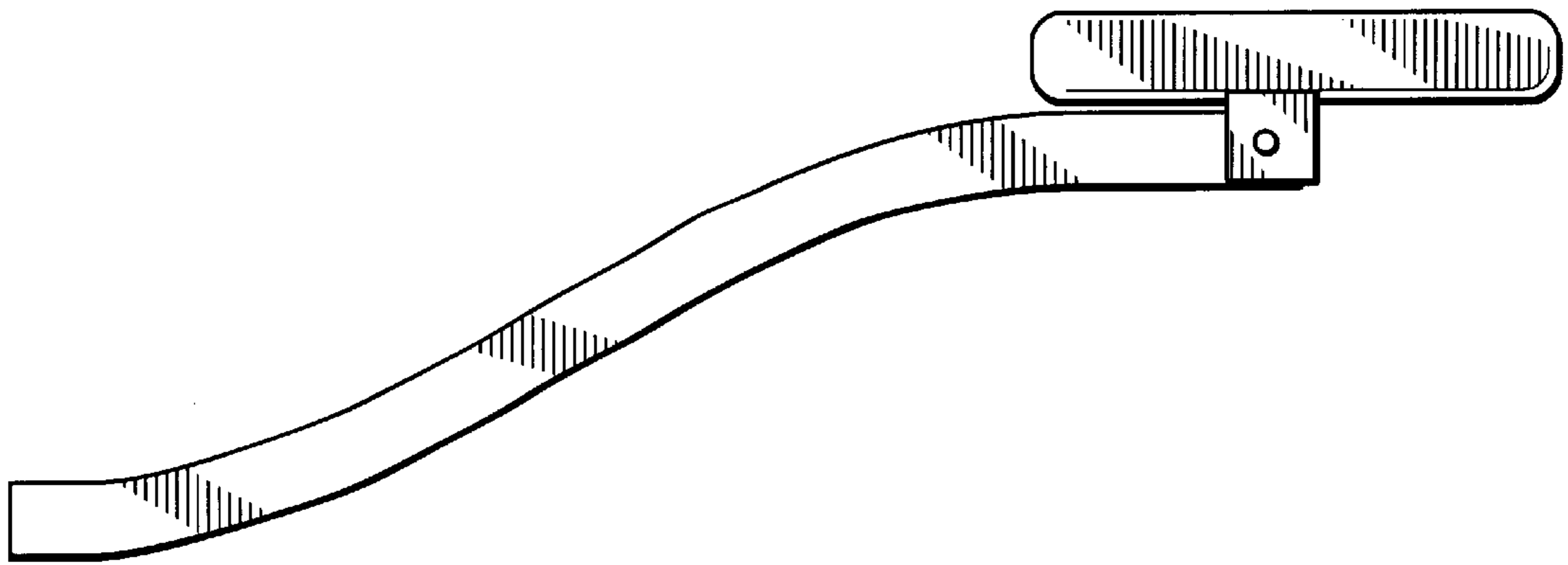

FIG. 34

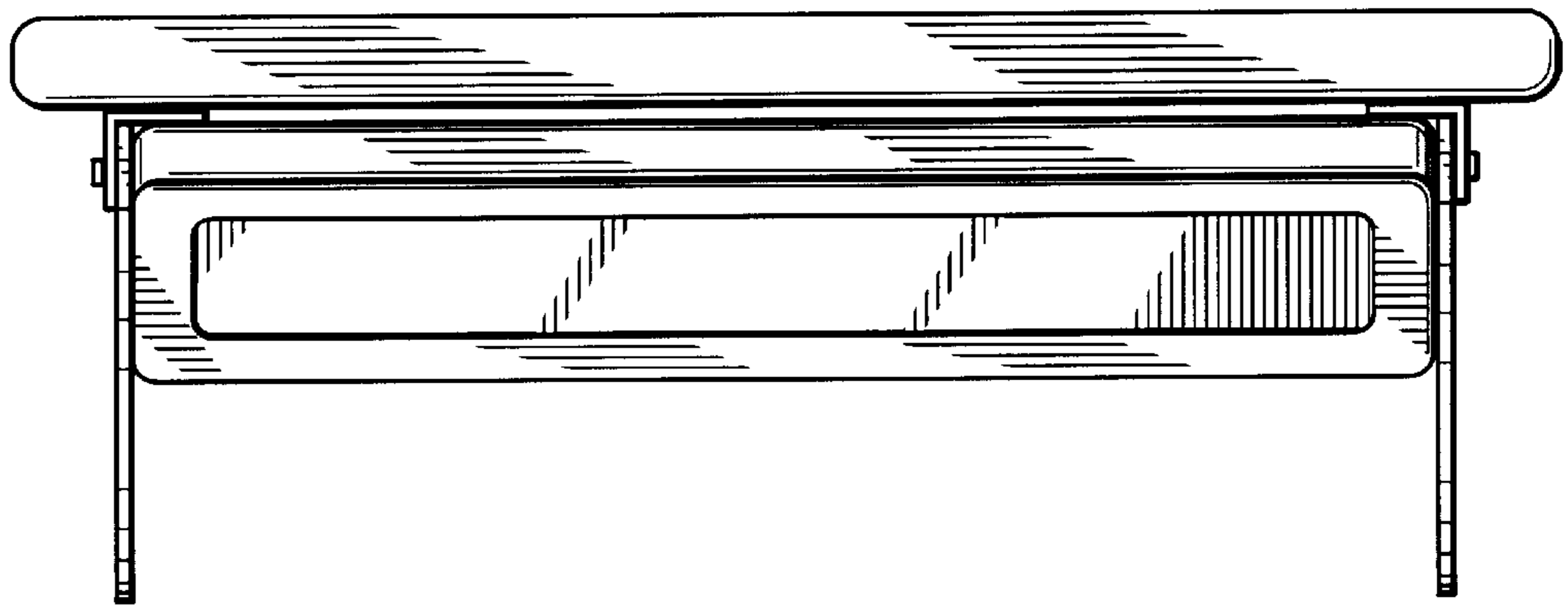

FIG. 35

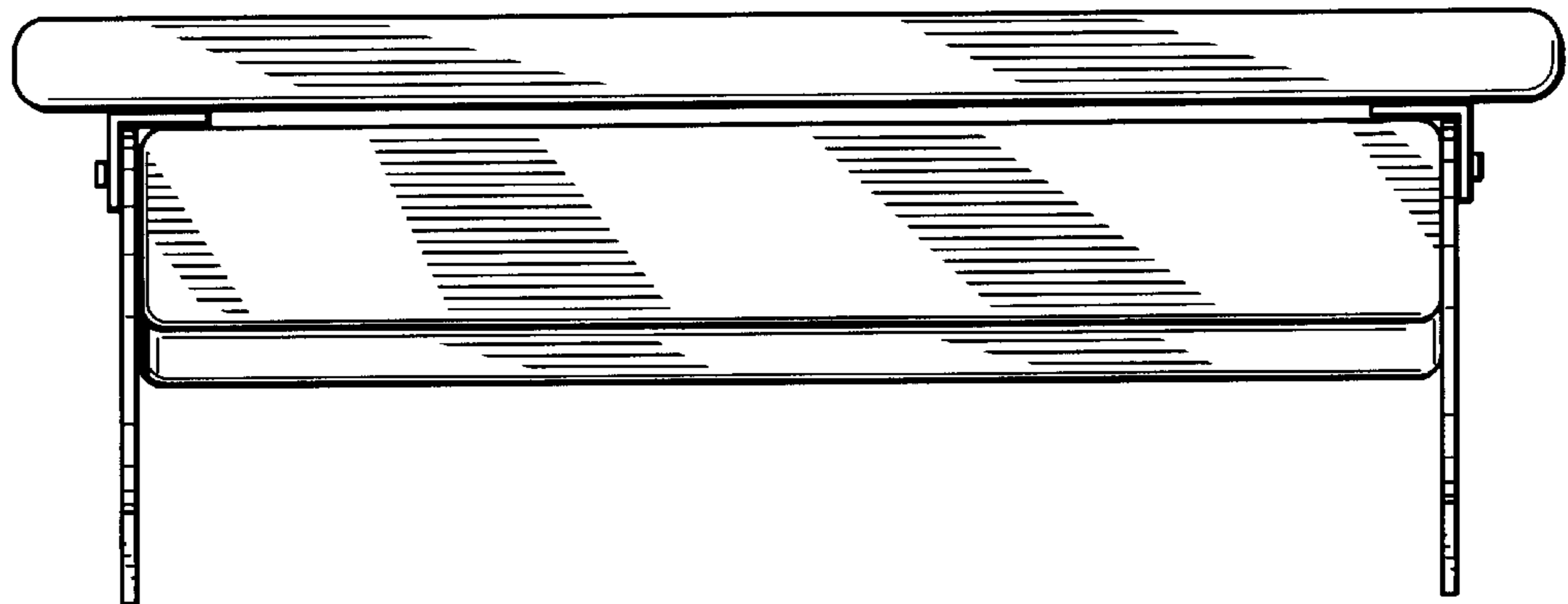

FIG. 36

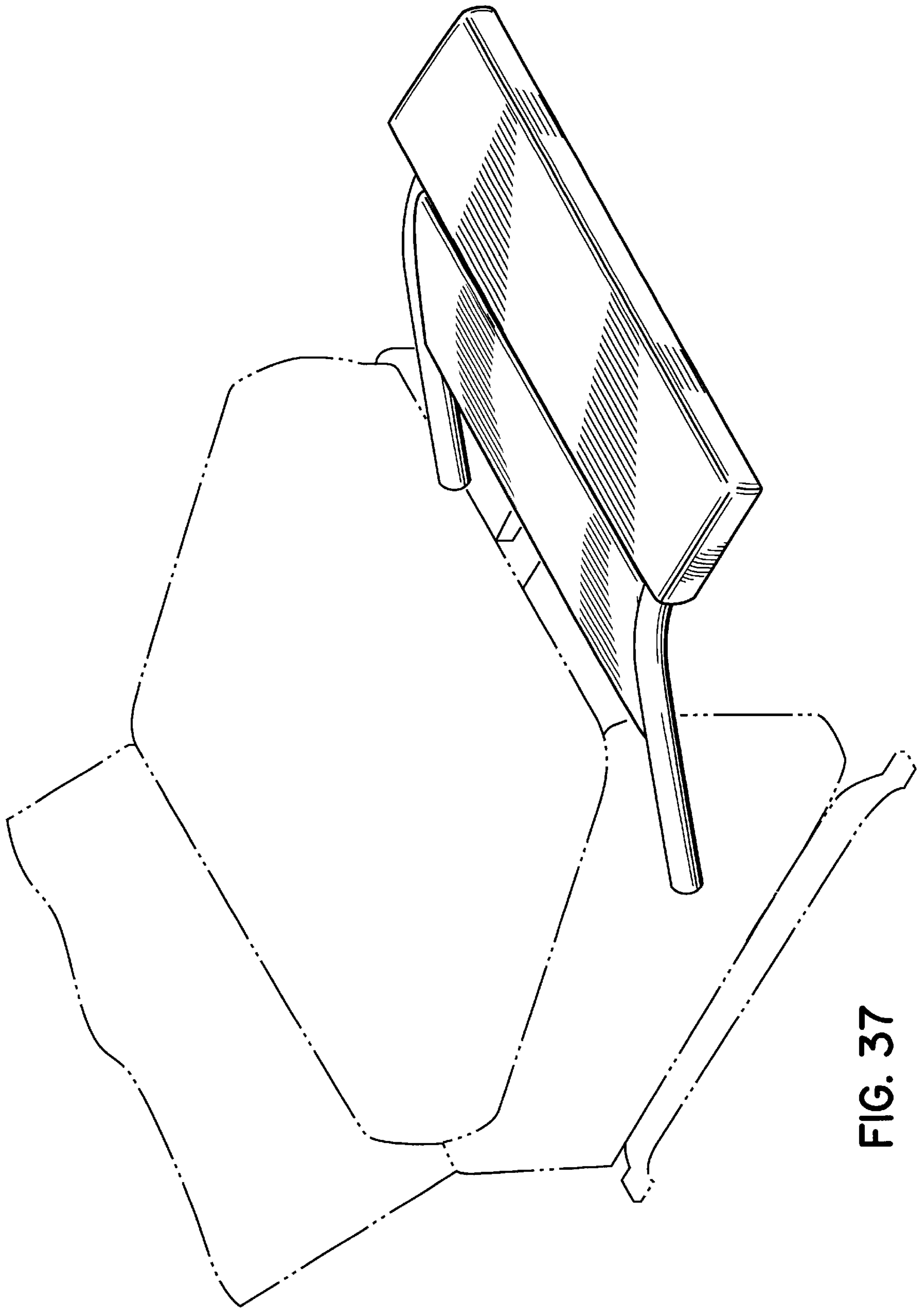

FIG. 37

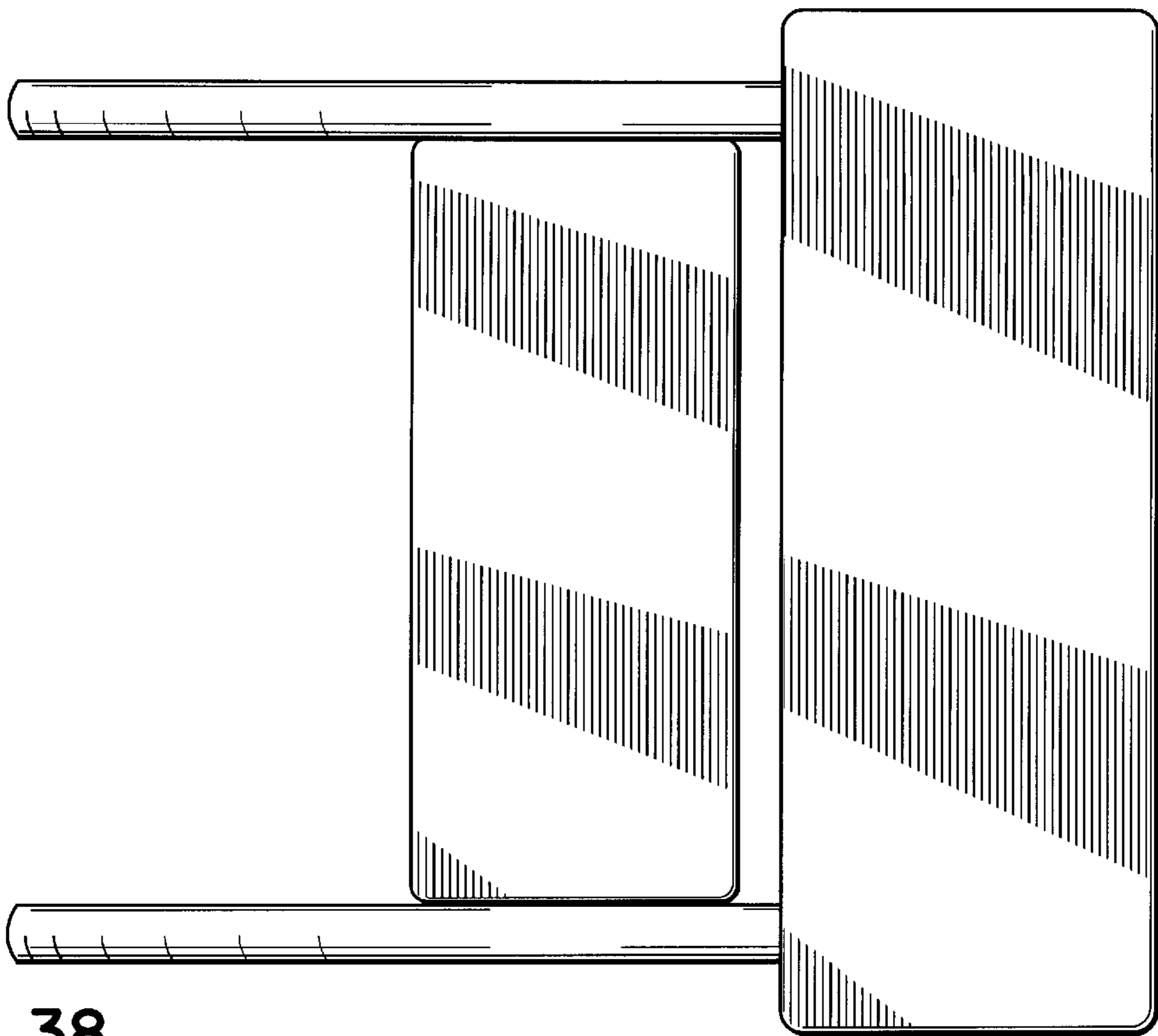

FIG. 38

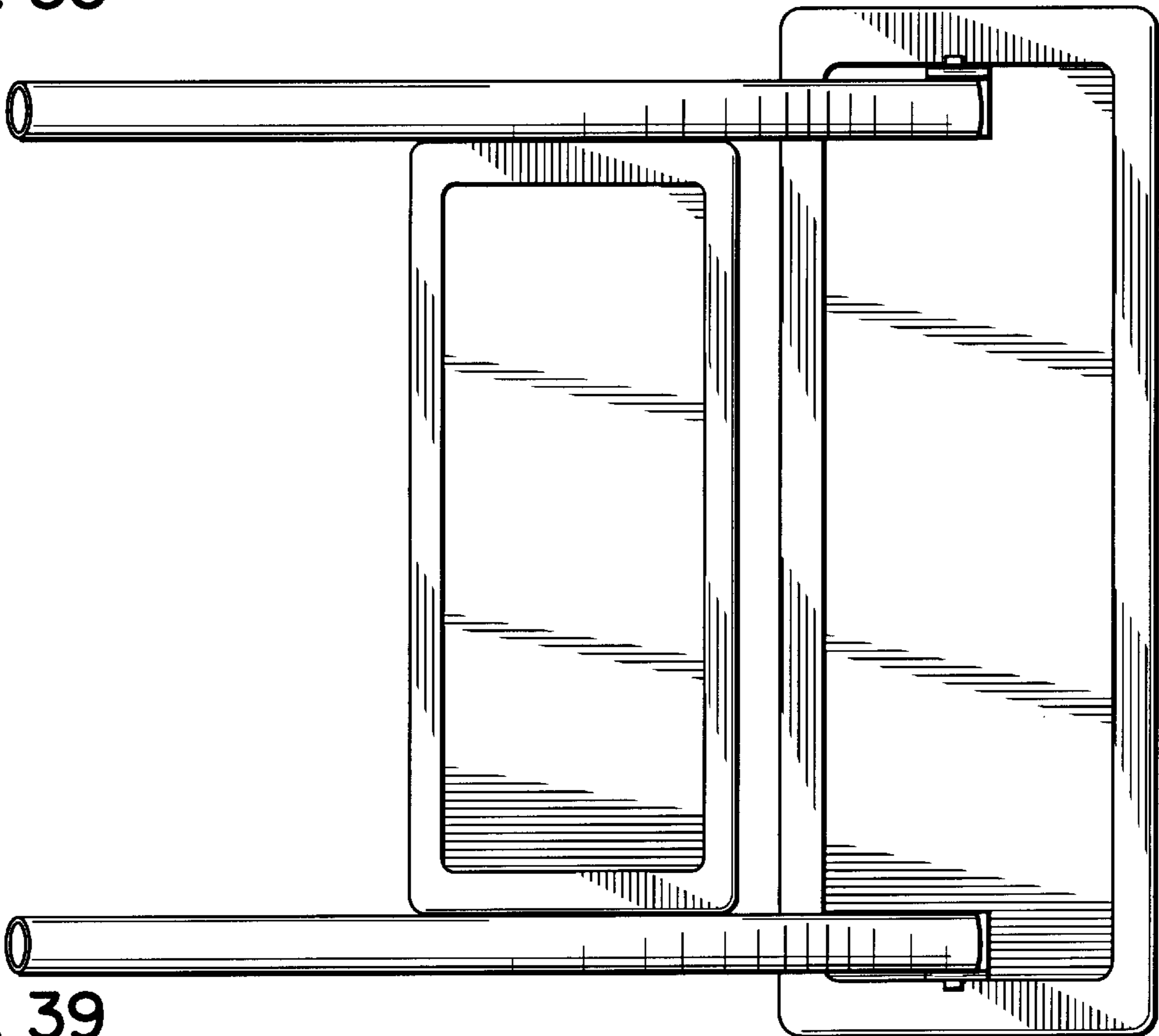

FIG. 39

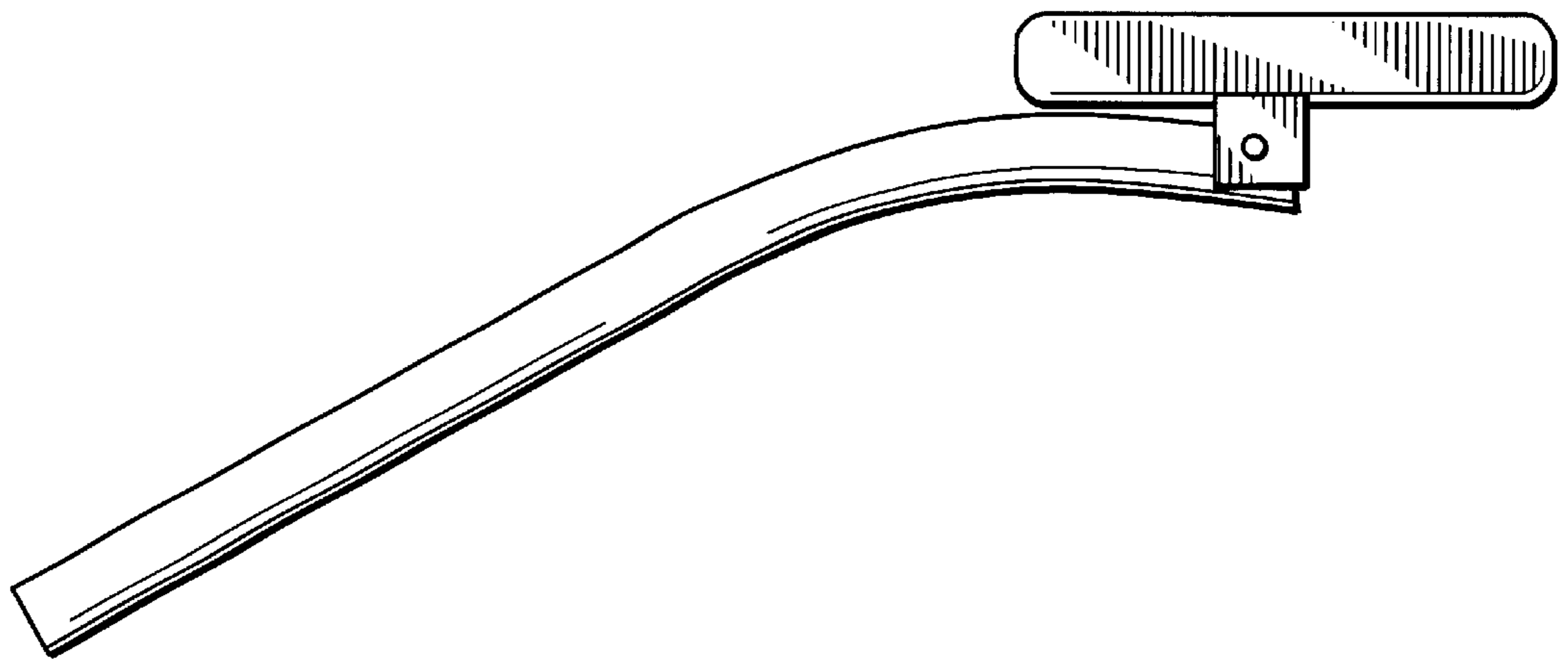

FIG. 40

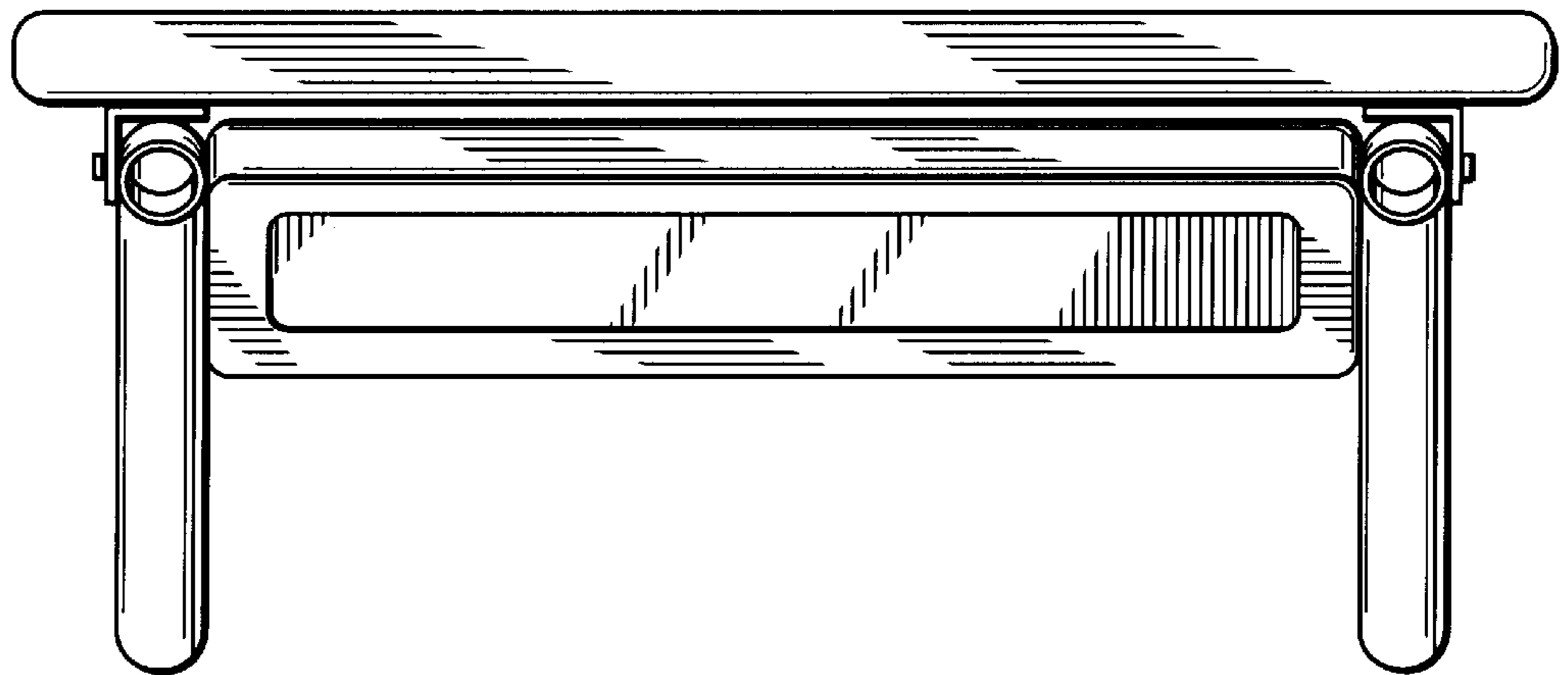

FIG. 41



FIG. 42

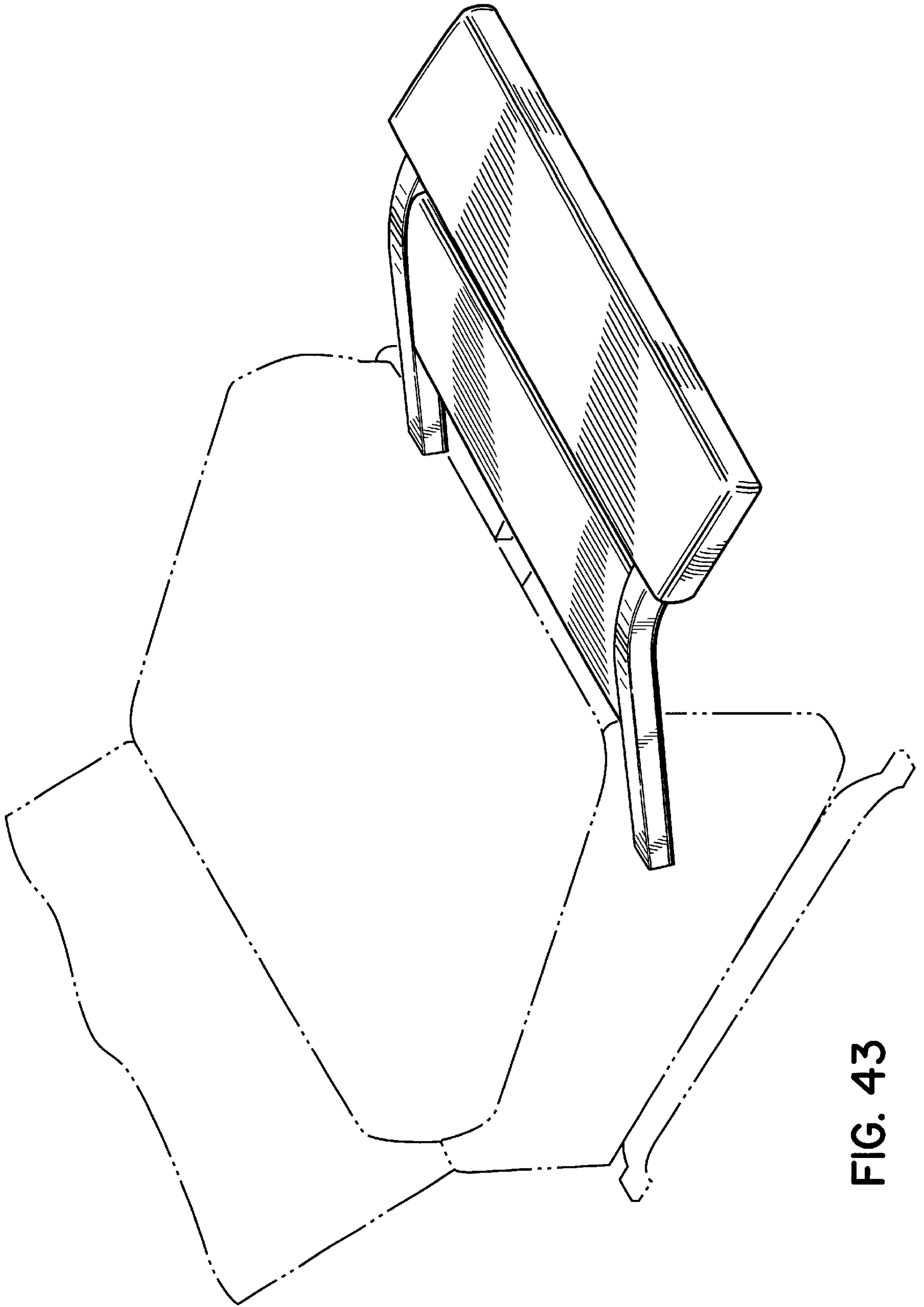

FIG. 43

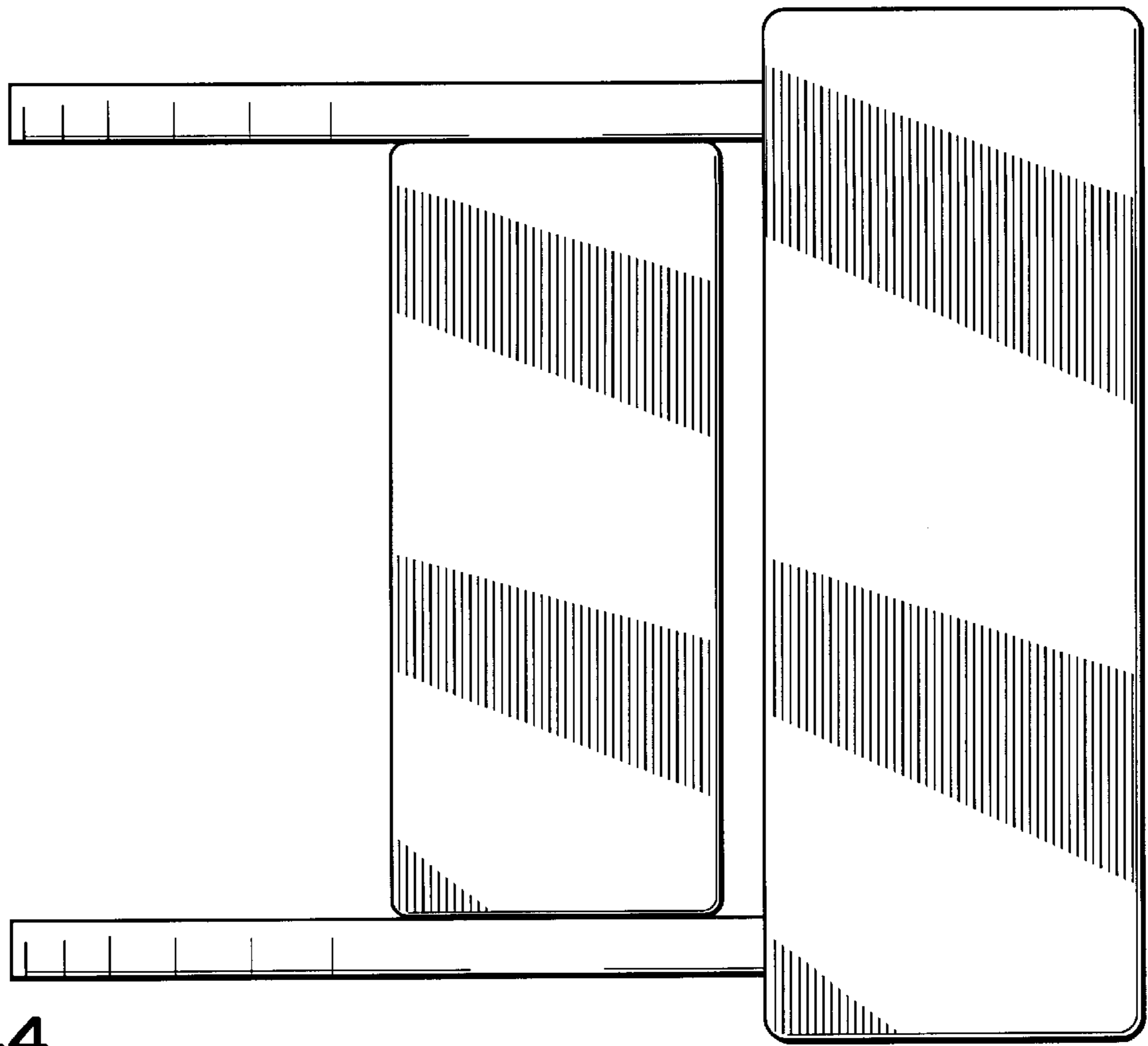

FIG. 44

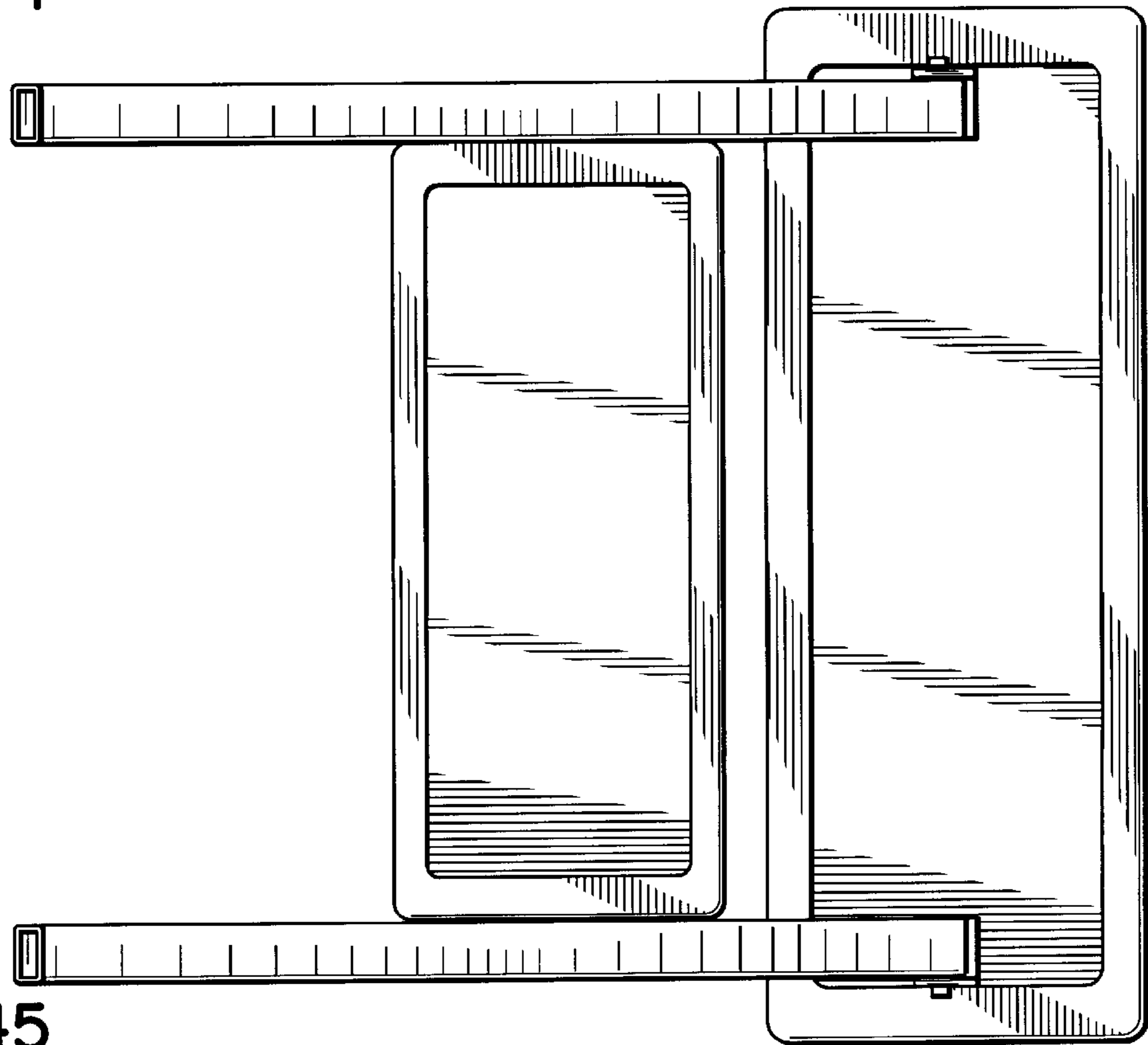

FIG. 45

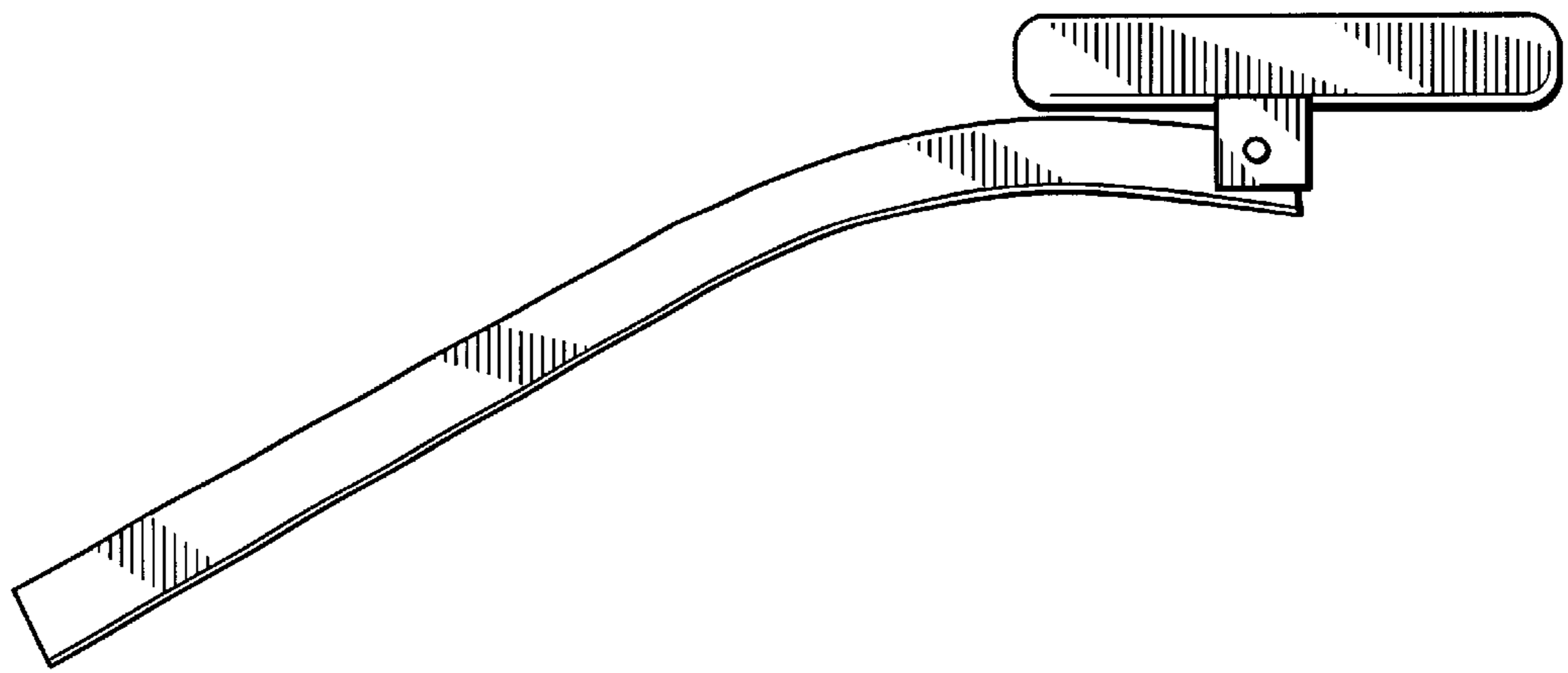

FIG. 46

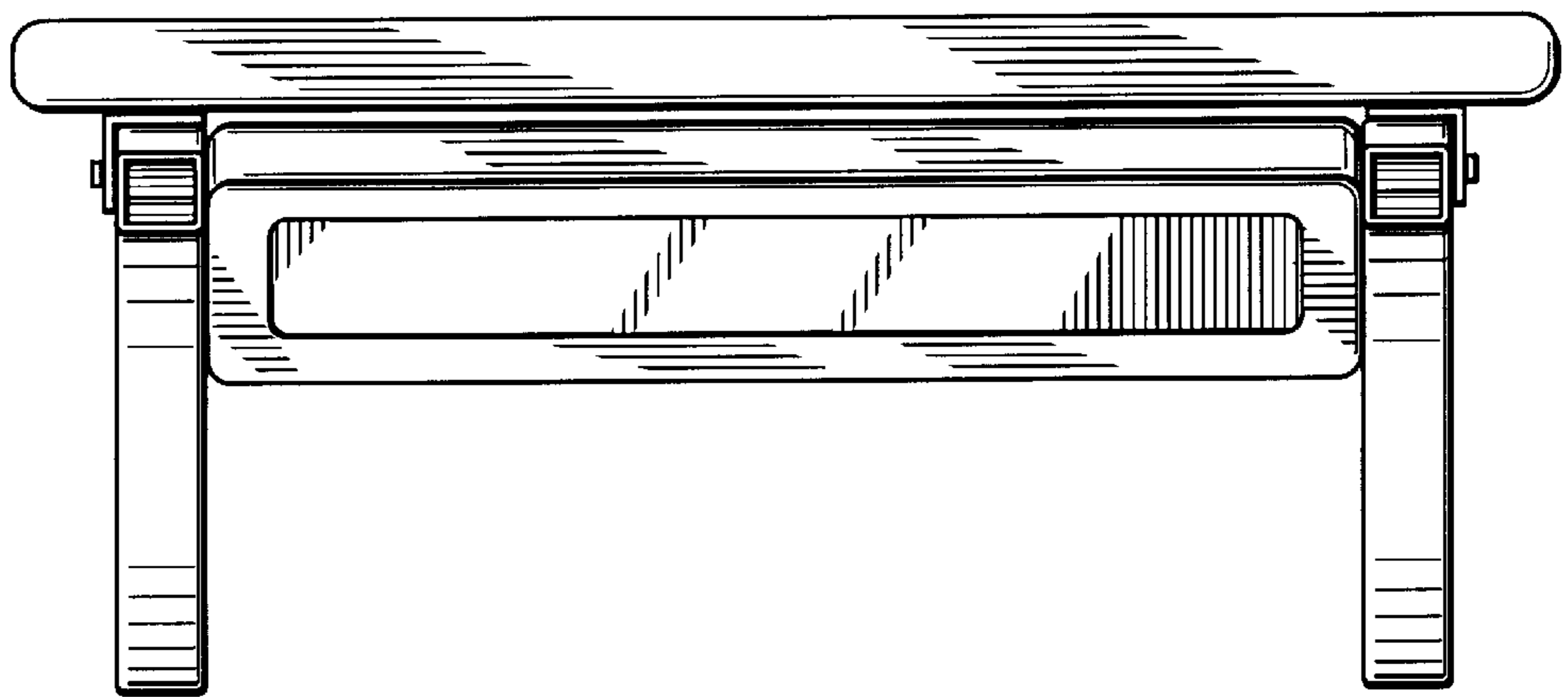

FIG. 47

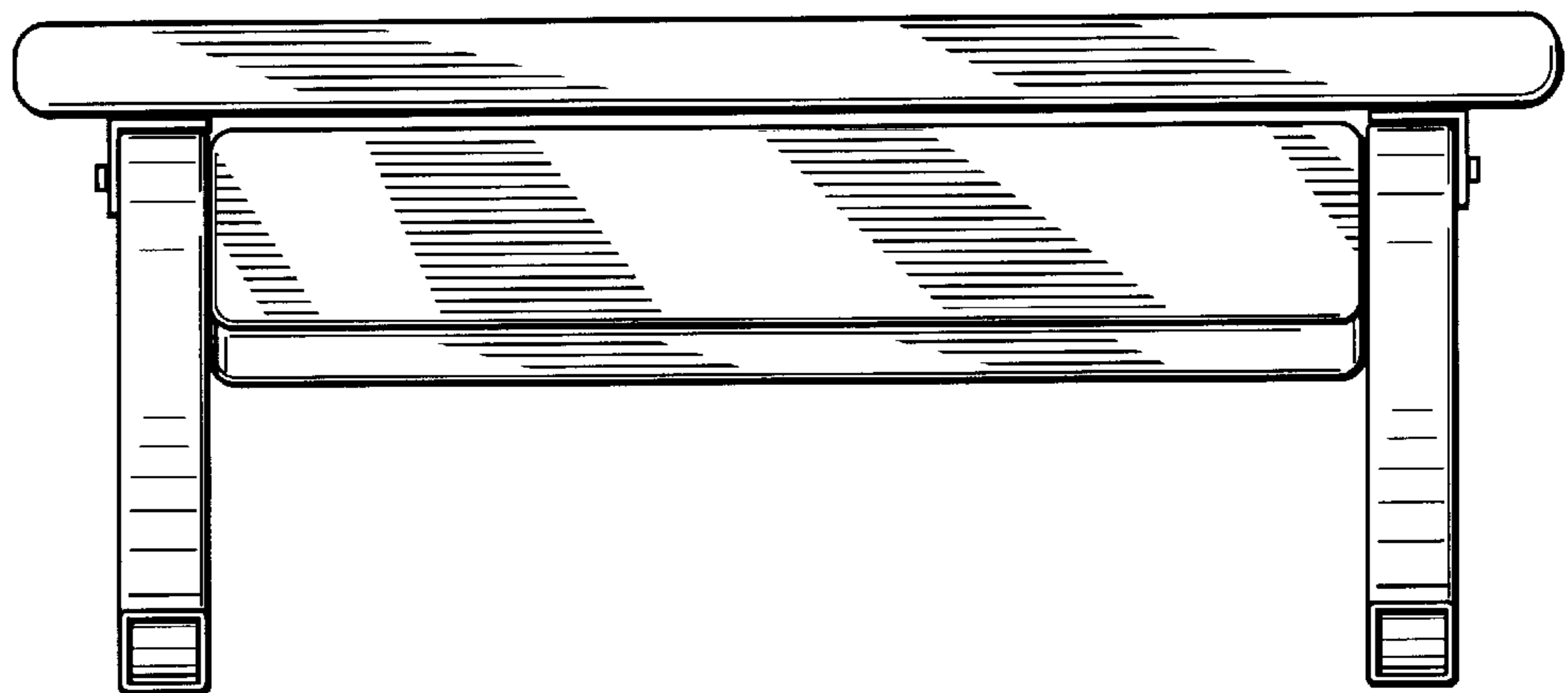

FIG. 48

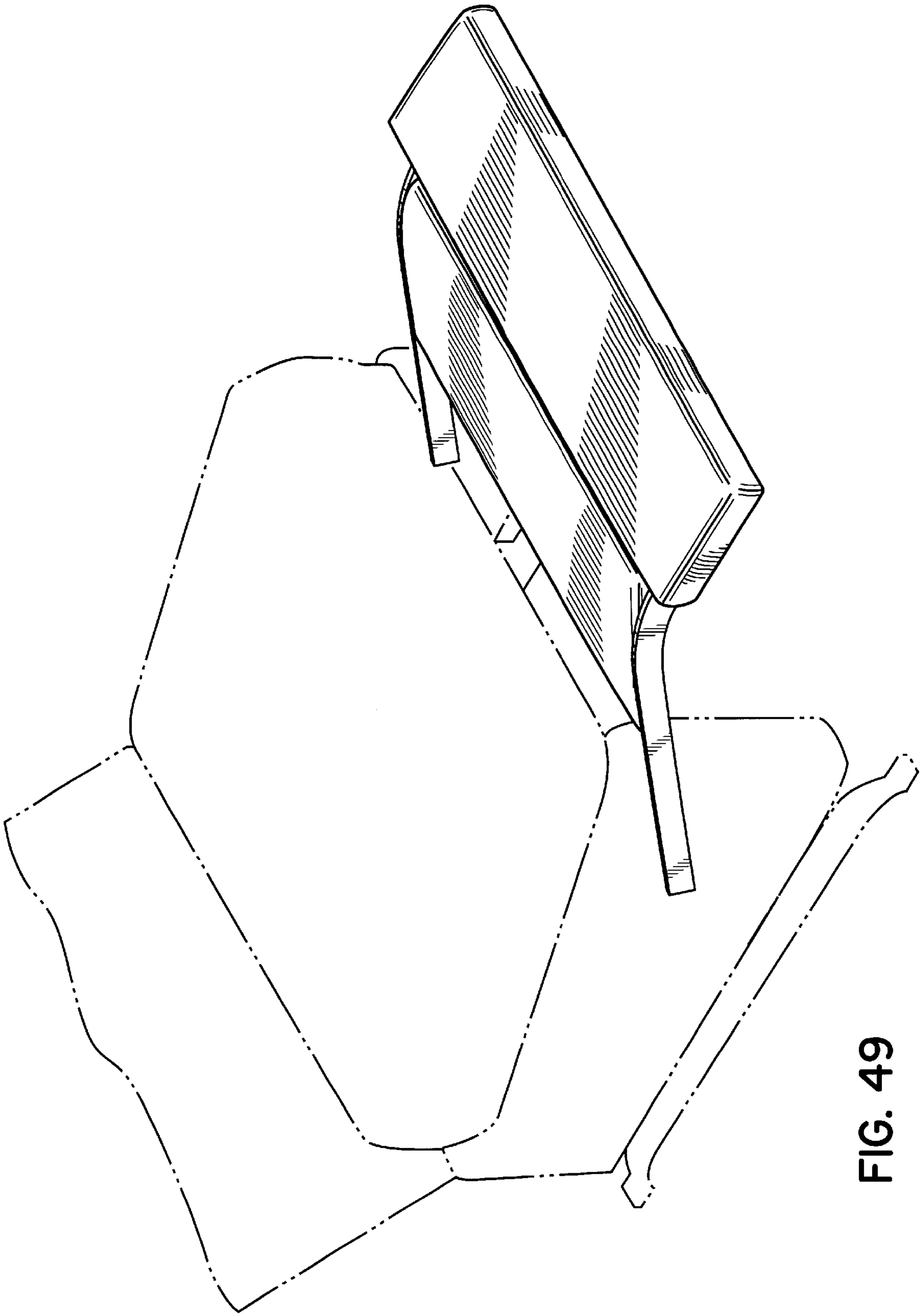

FIG. 49

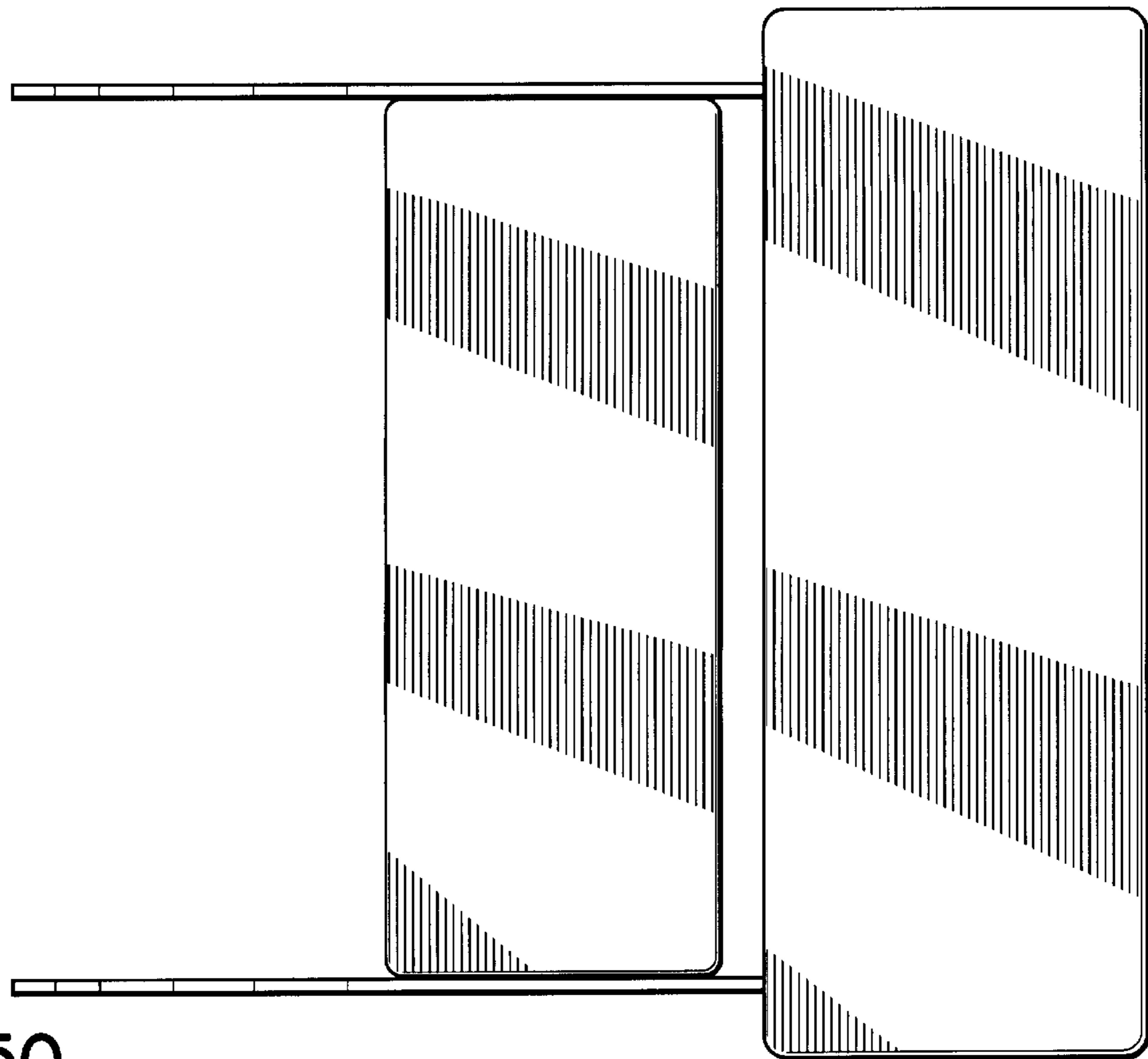

FIG. 50

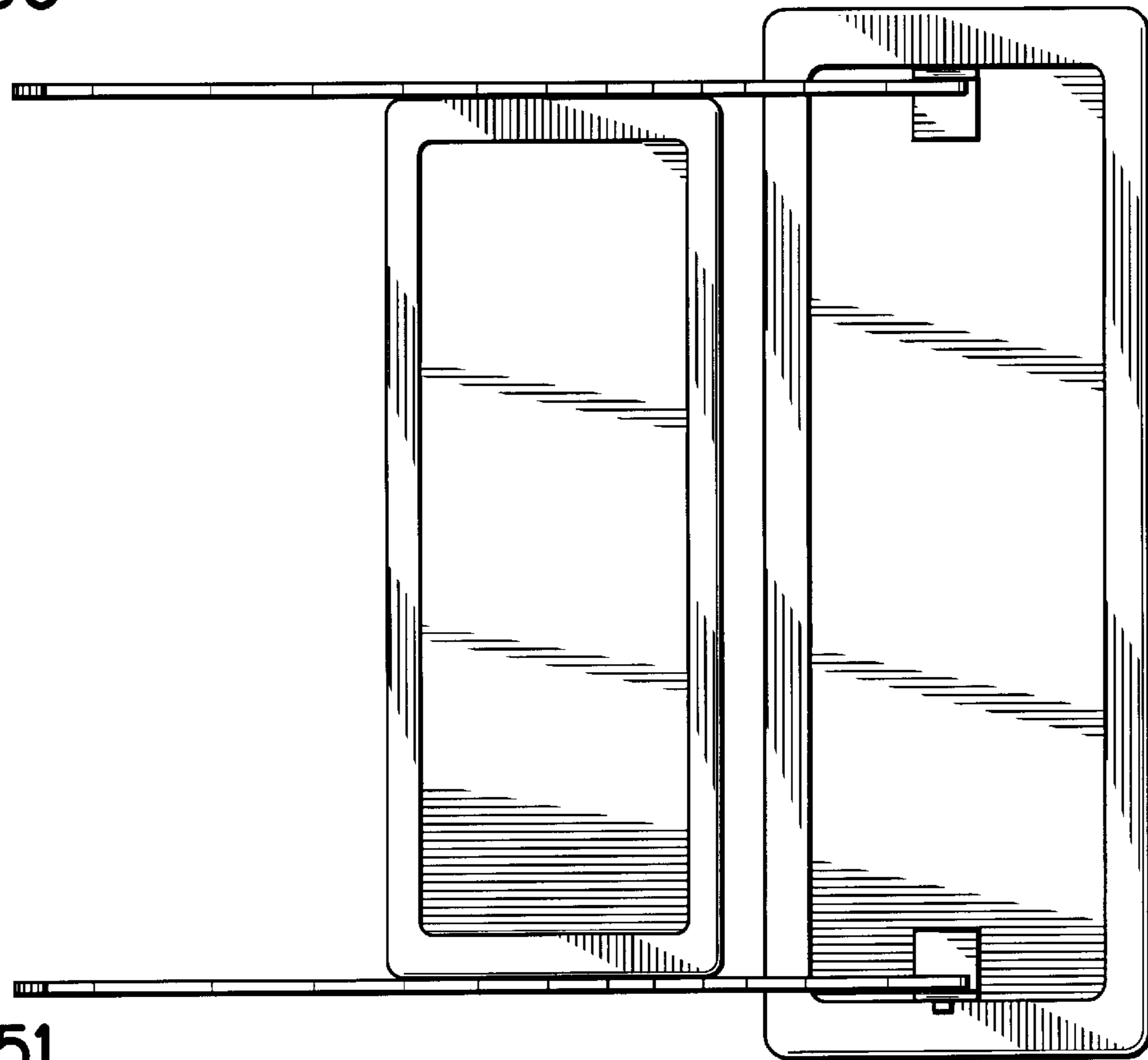

FIG. 51

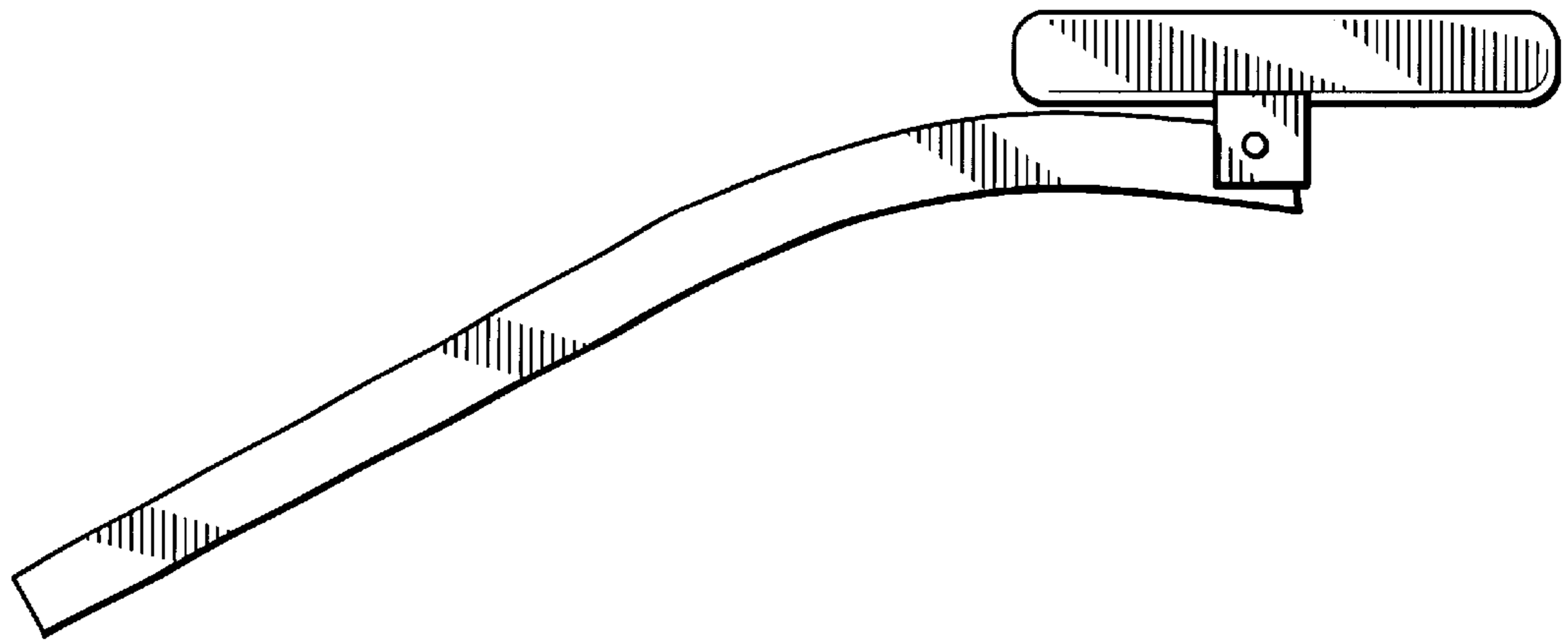

FIG. 52

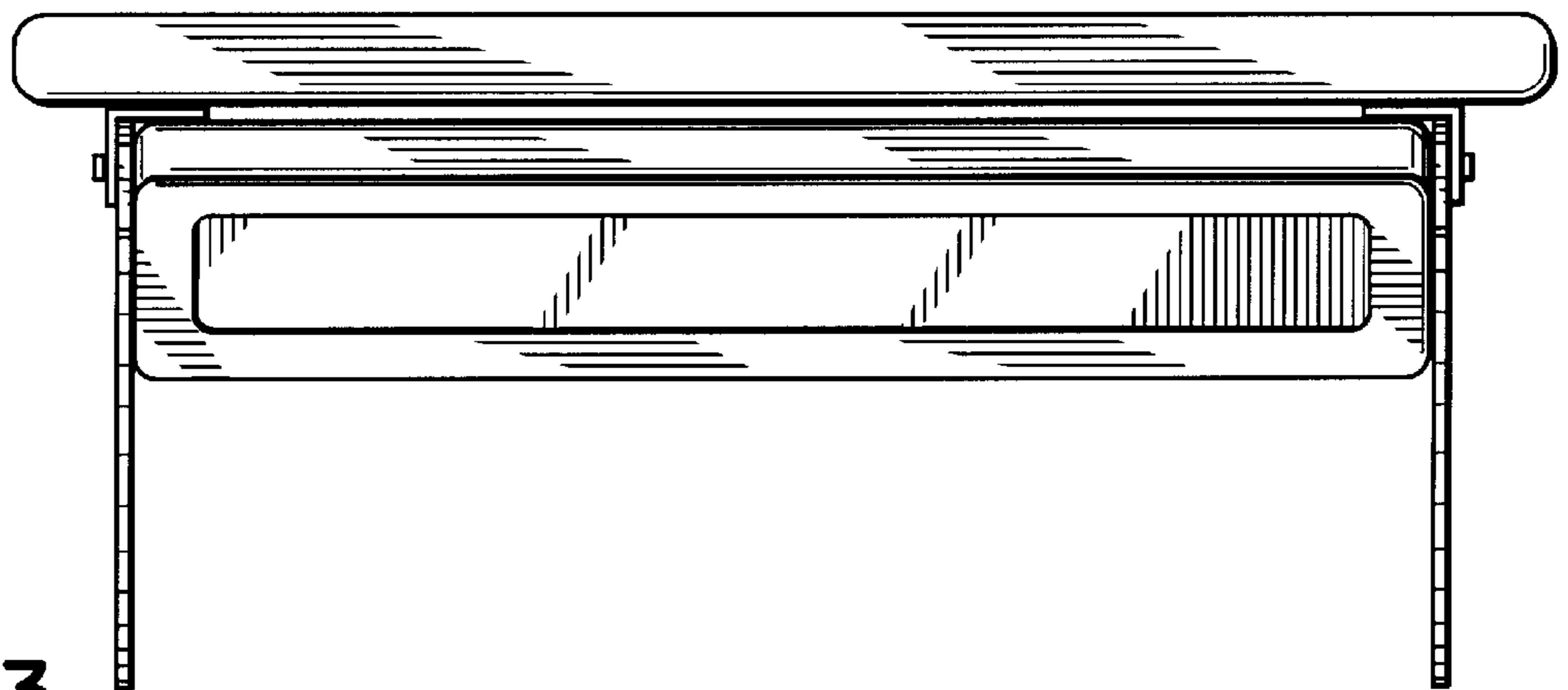

FIG. 53



FIG. 54

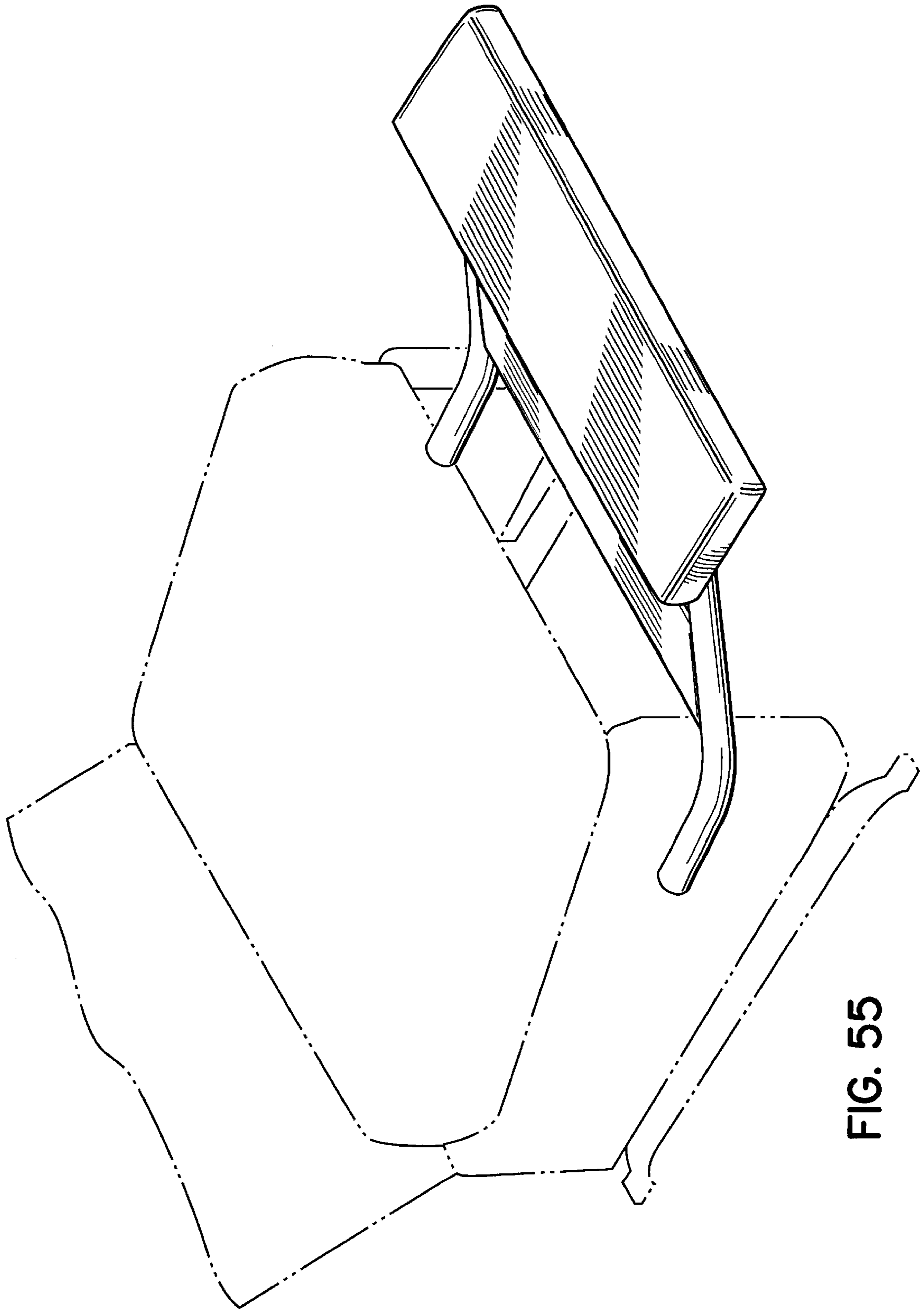

FIG. 55

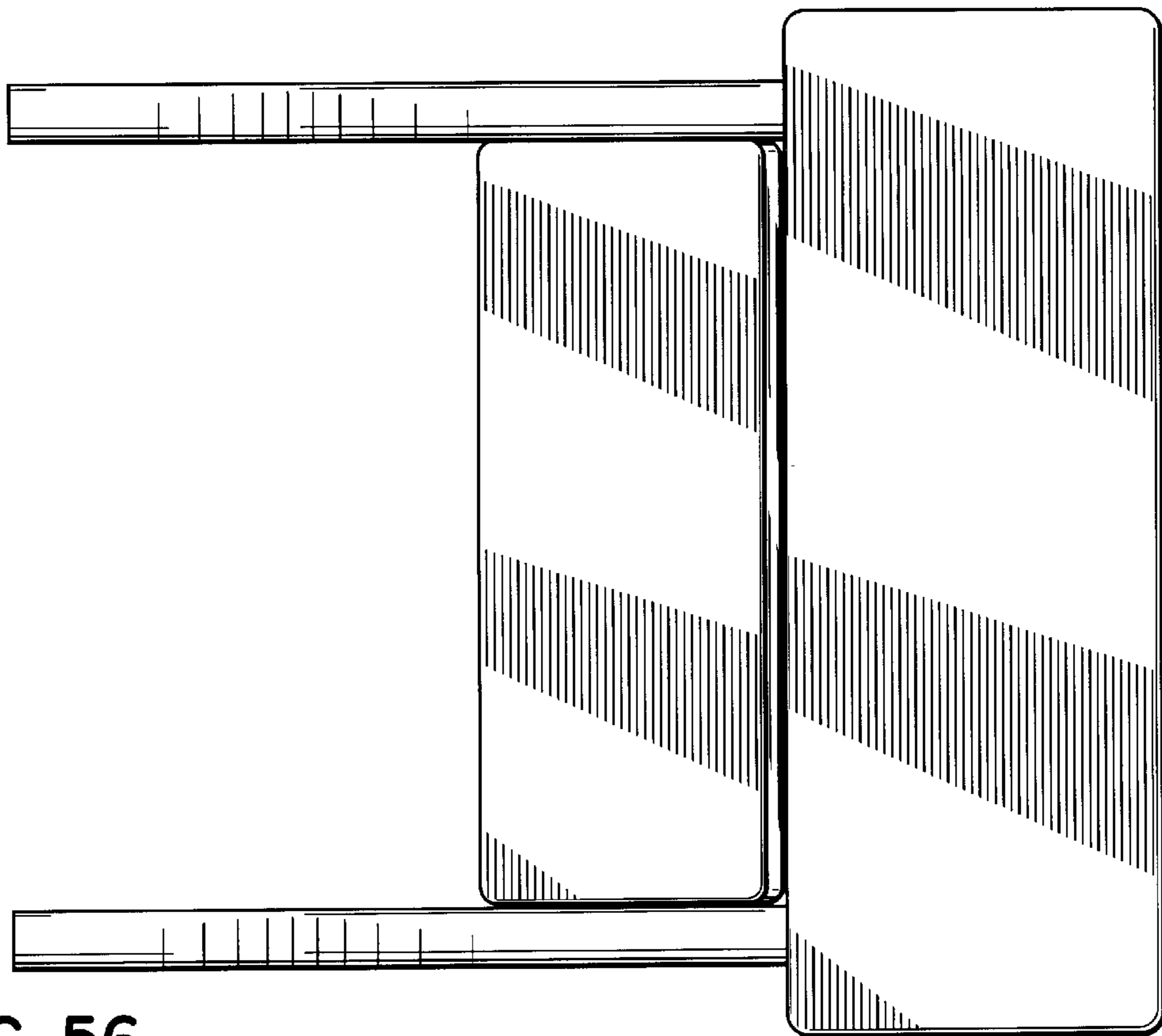

FIG. 56

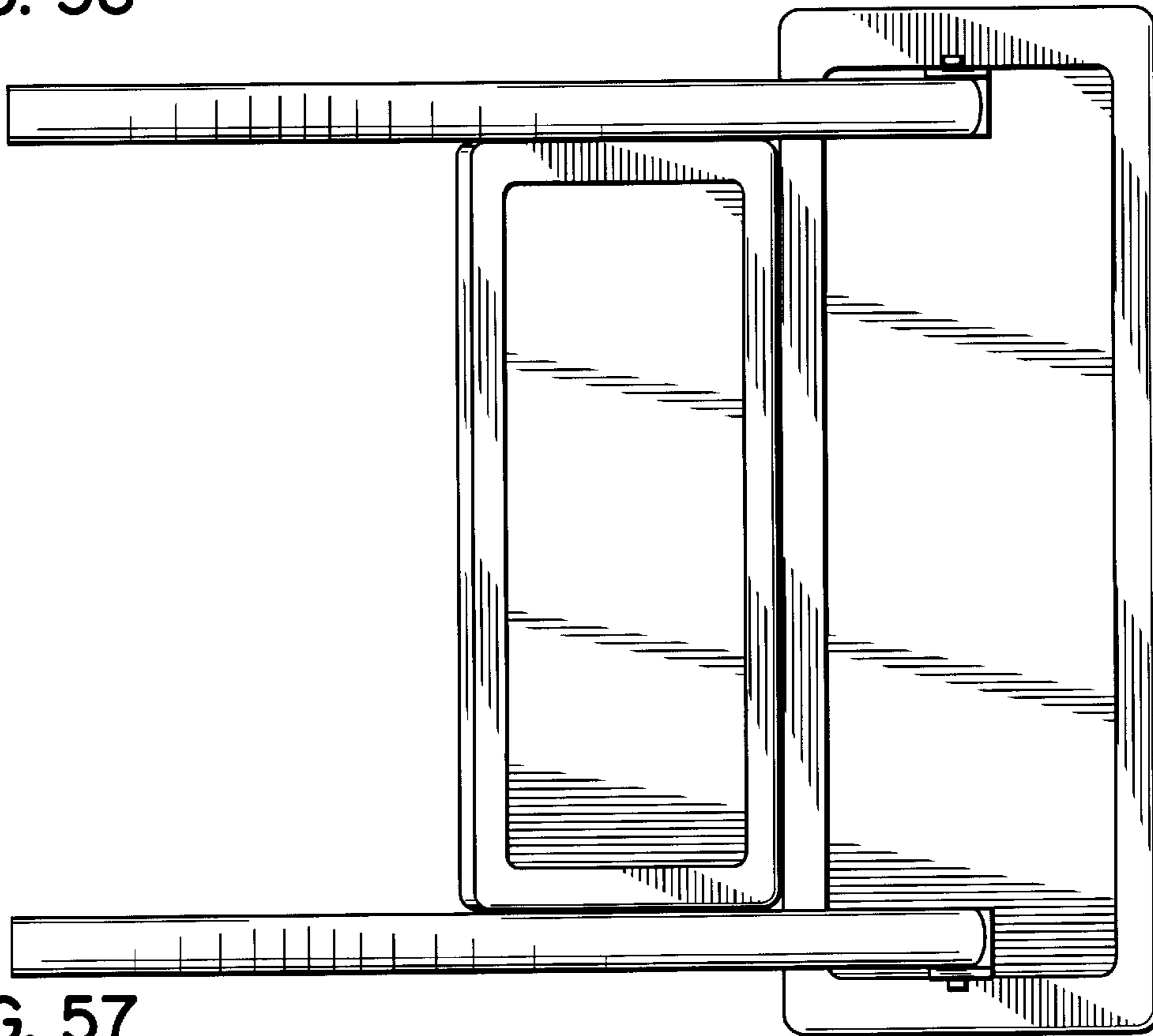

FIG. 57

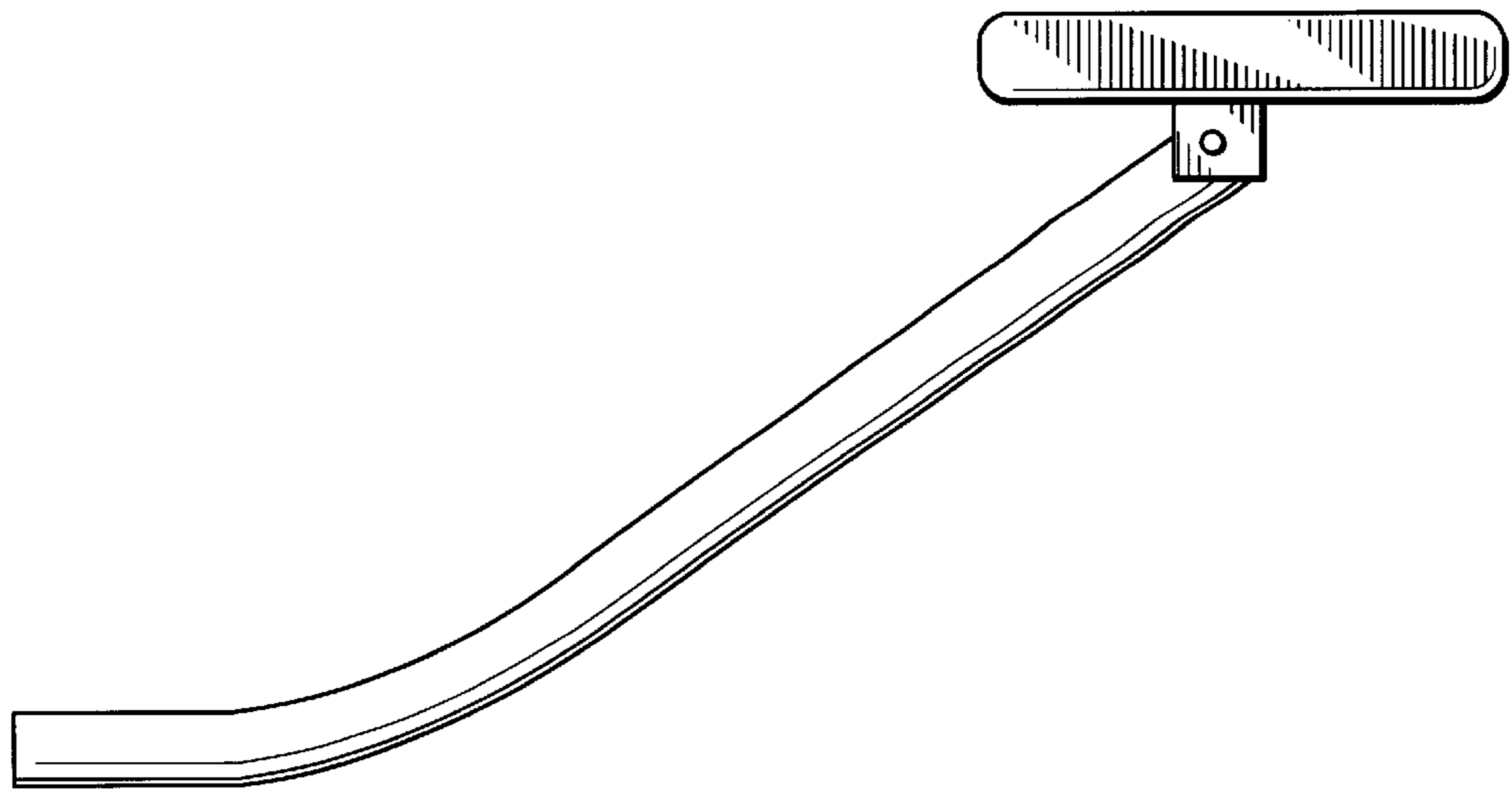

FIG. 58

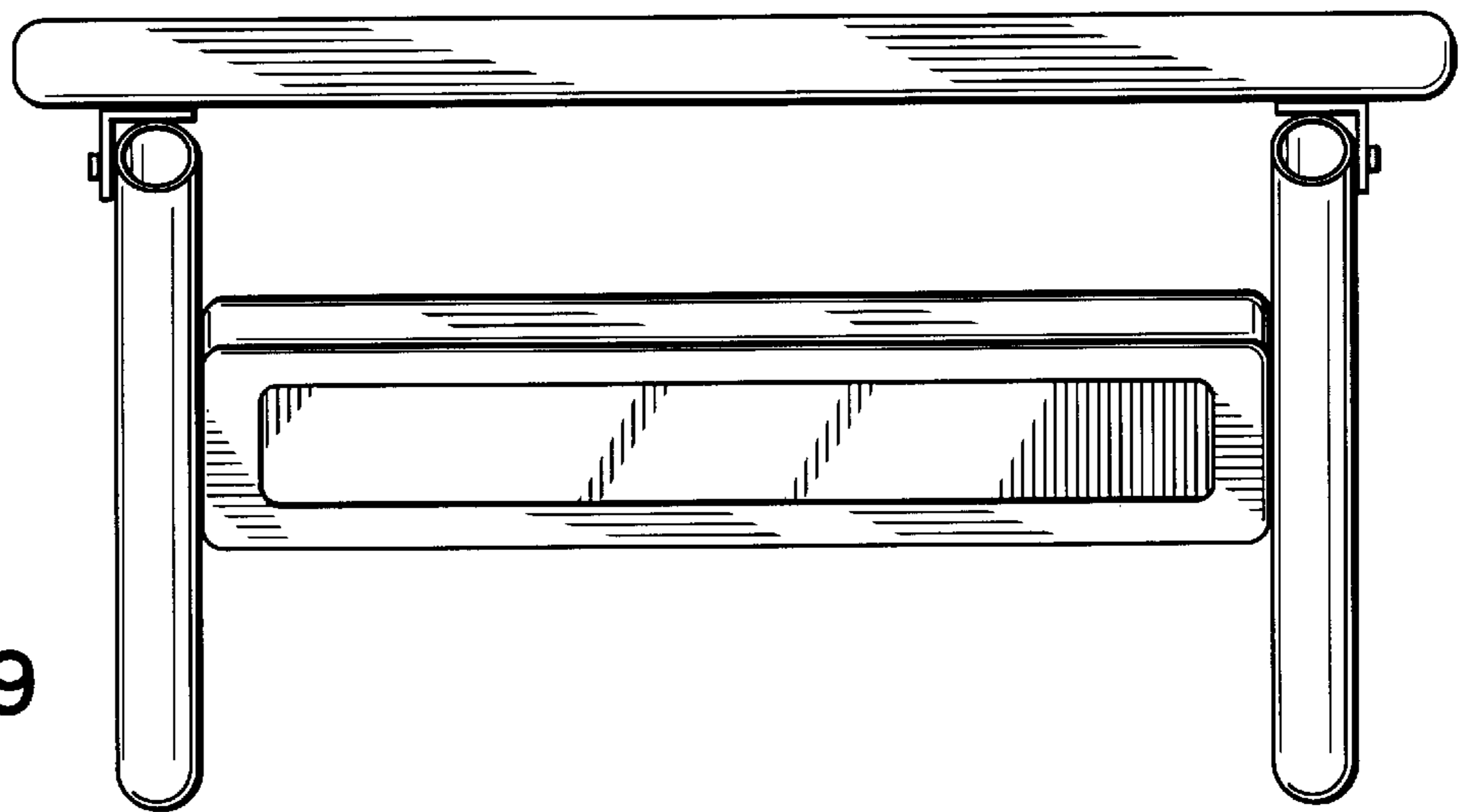

FIG. 59

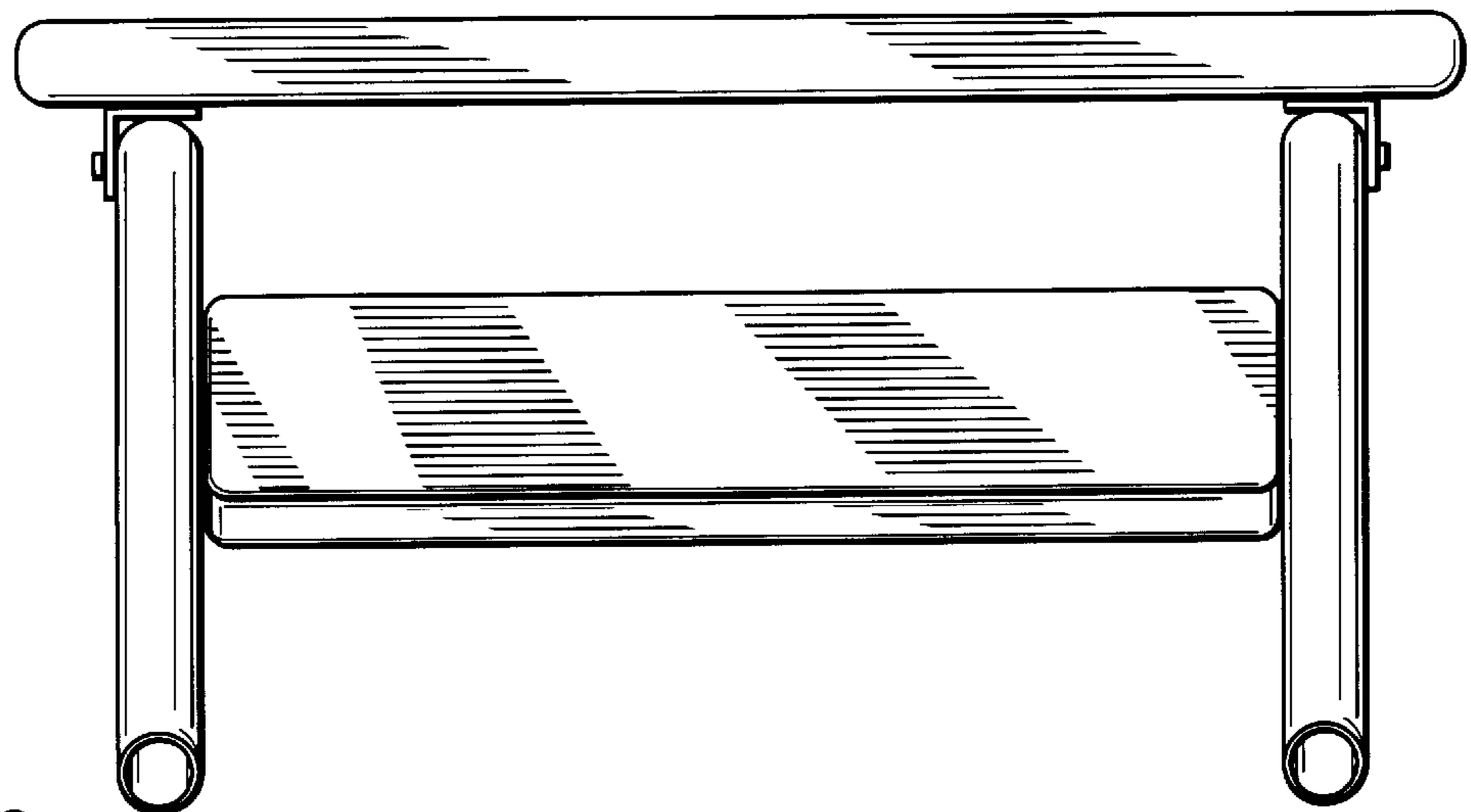

FIG. 60

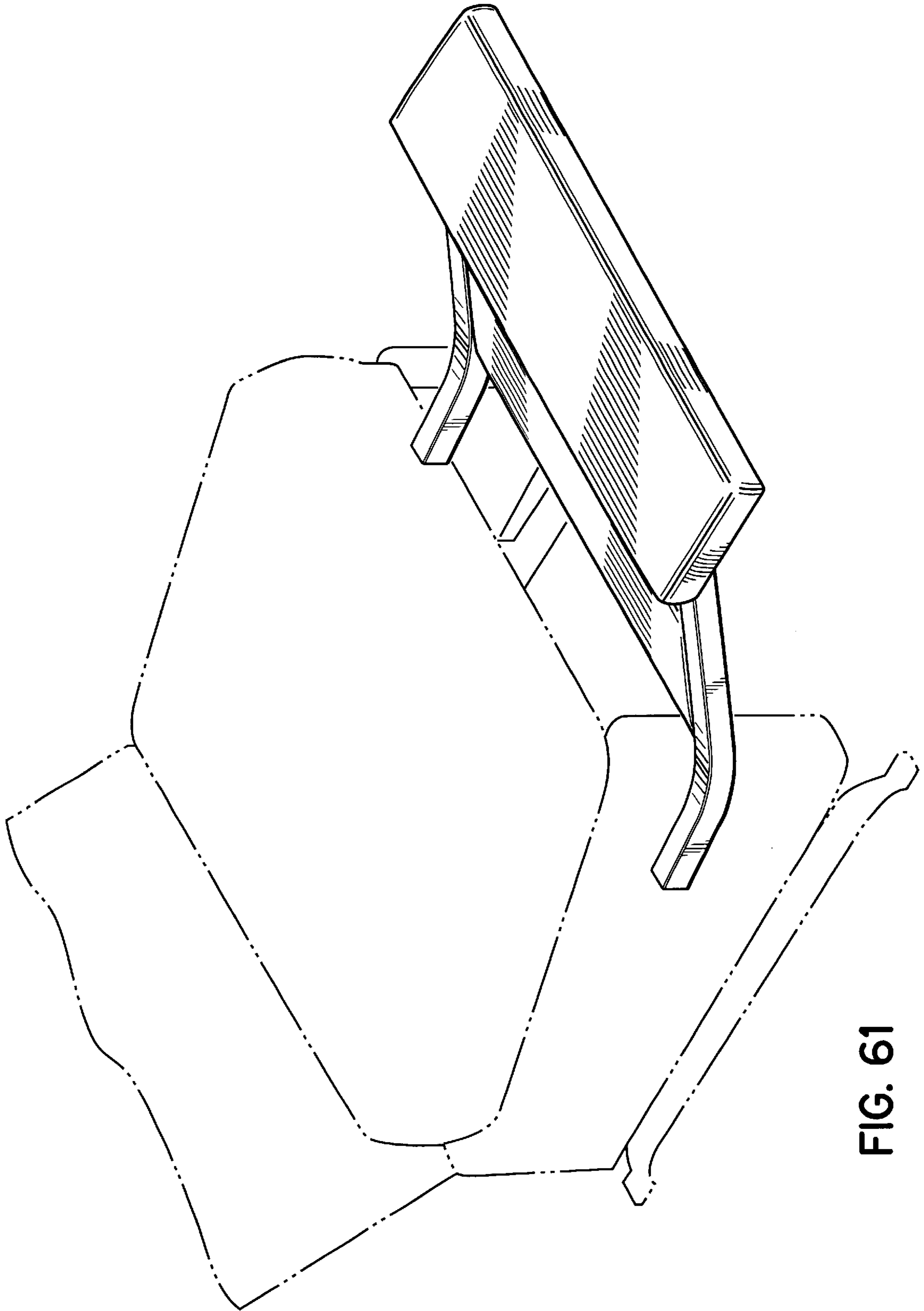

FIG. 61

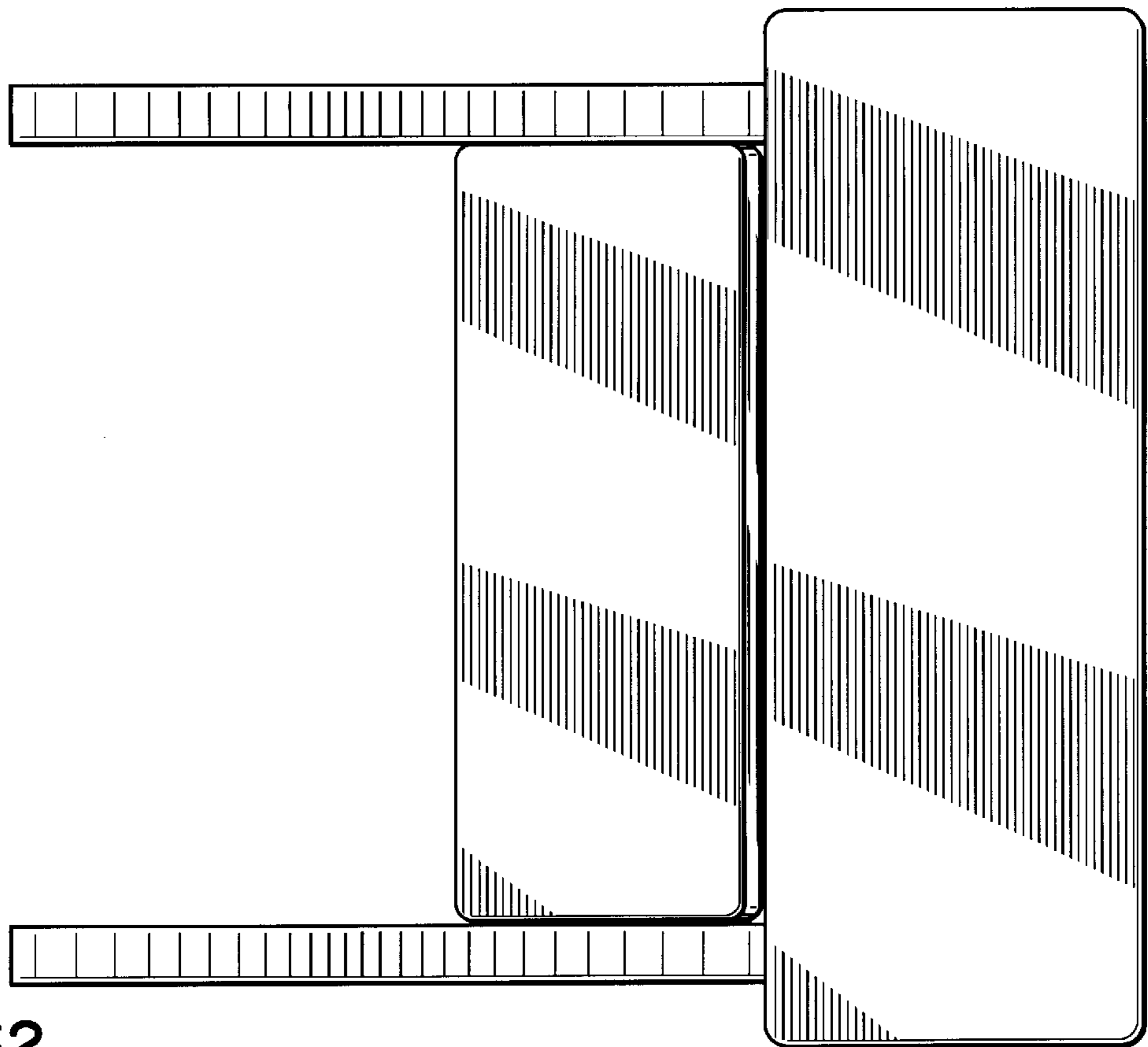

FIG. 62

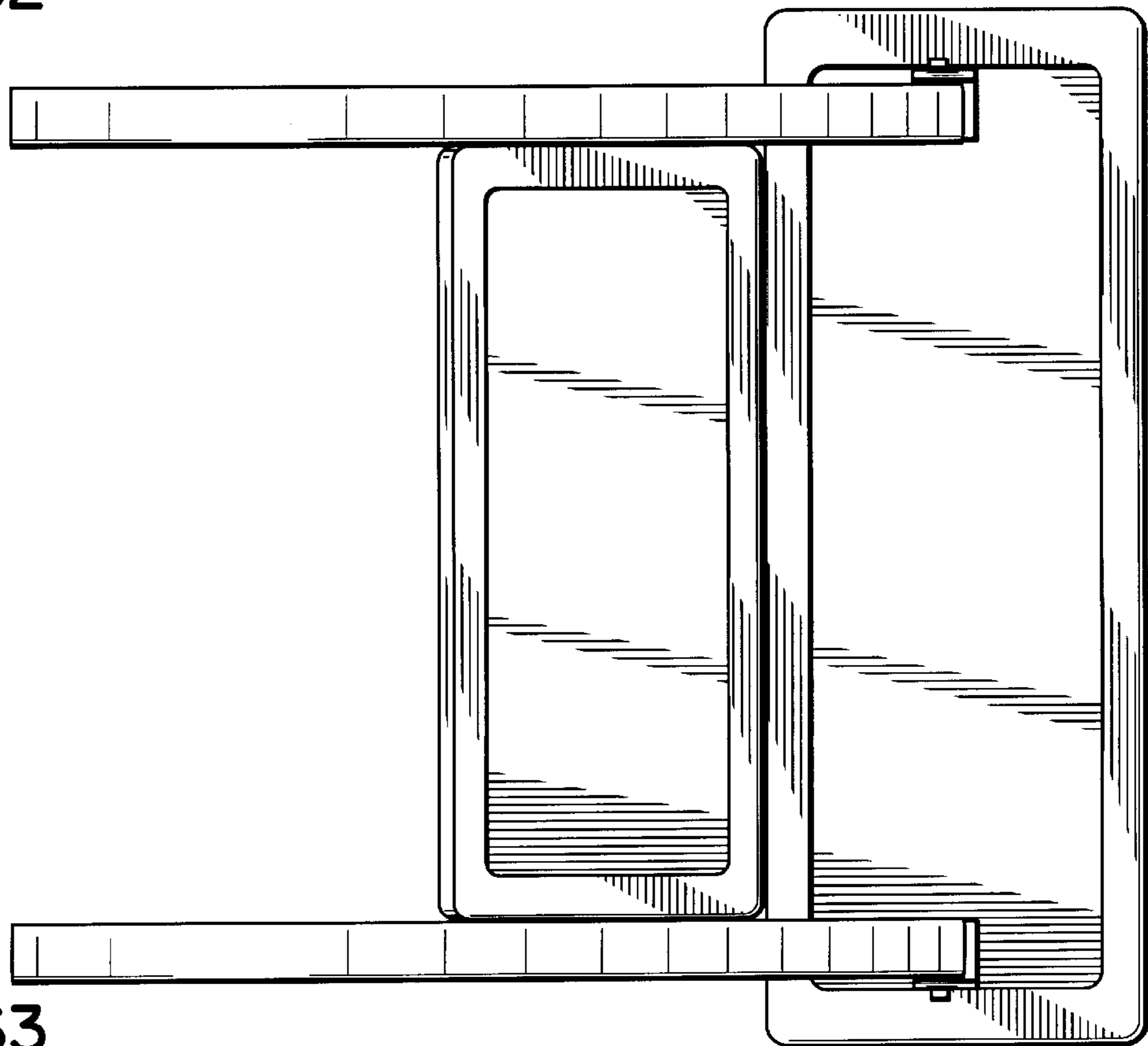

FIG. 63

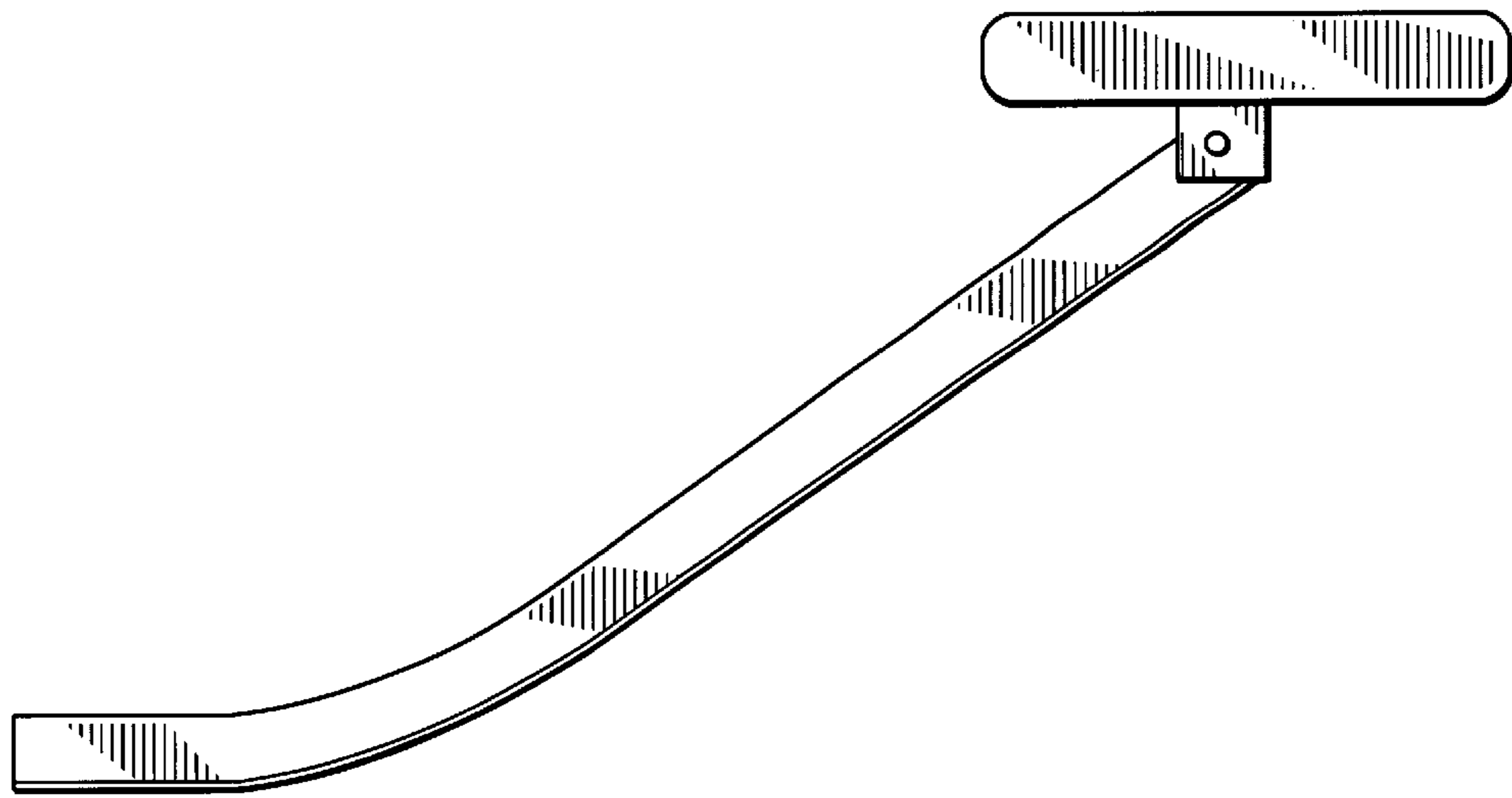

FIG. 64

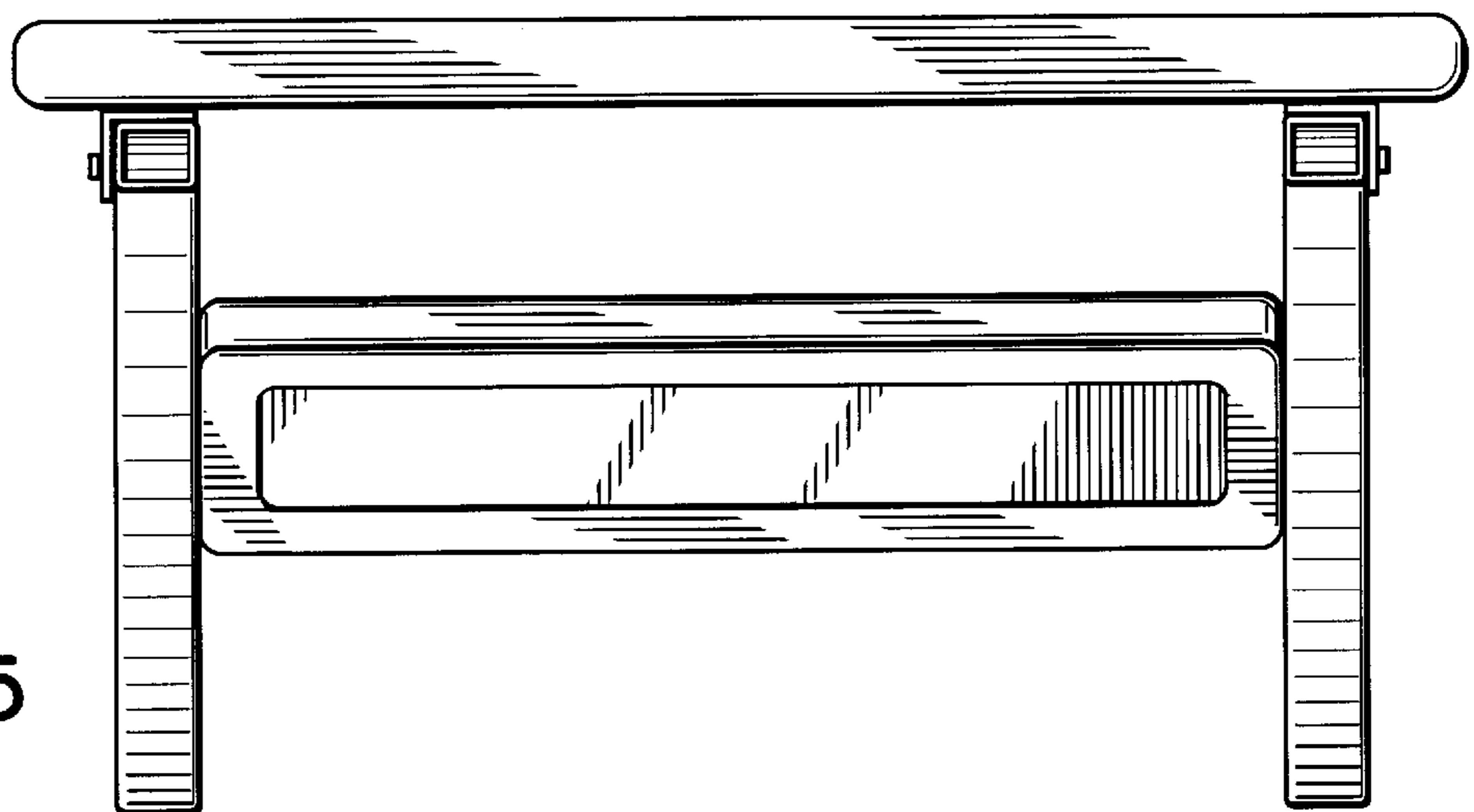

FIG. 65

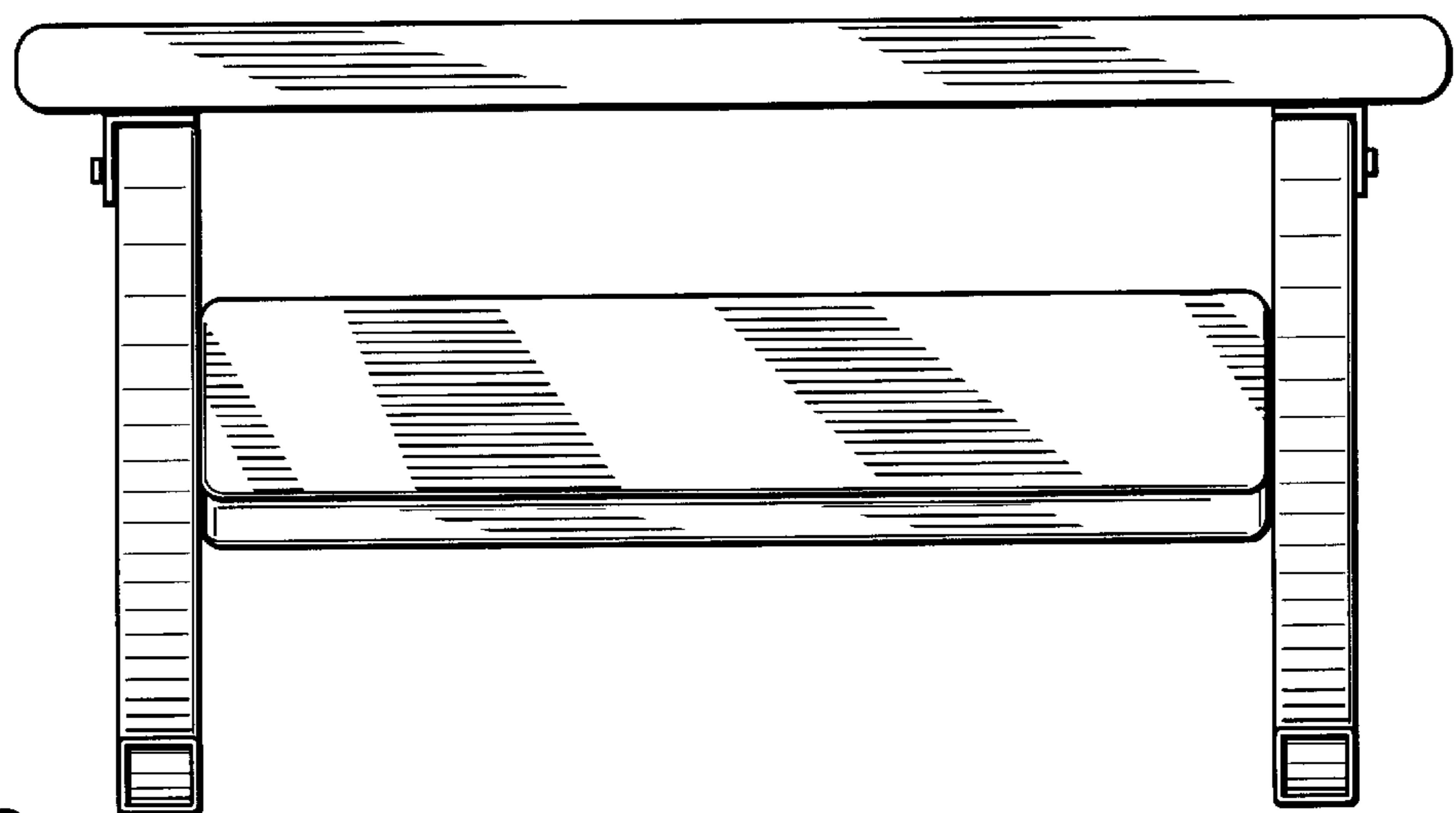

FIG. 66

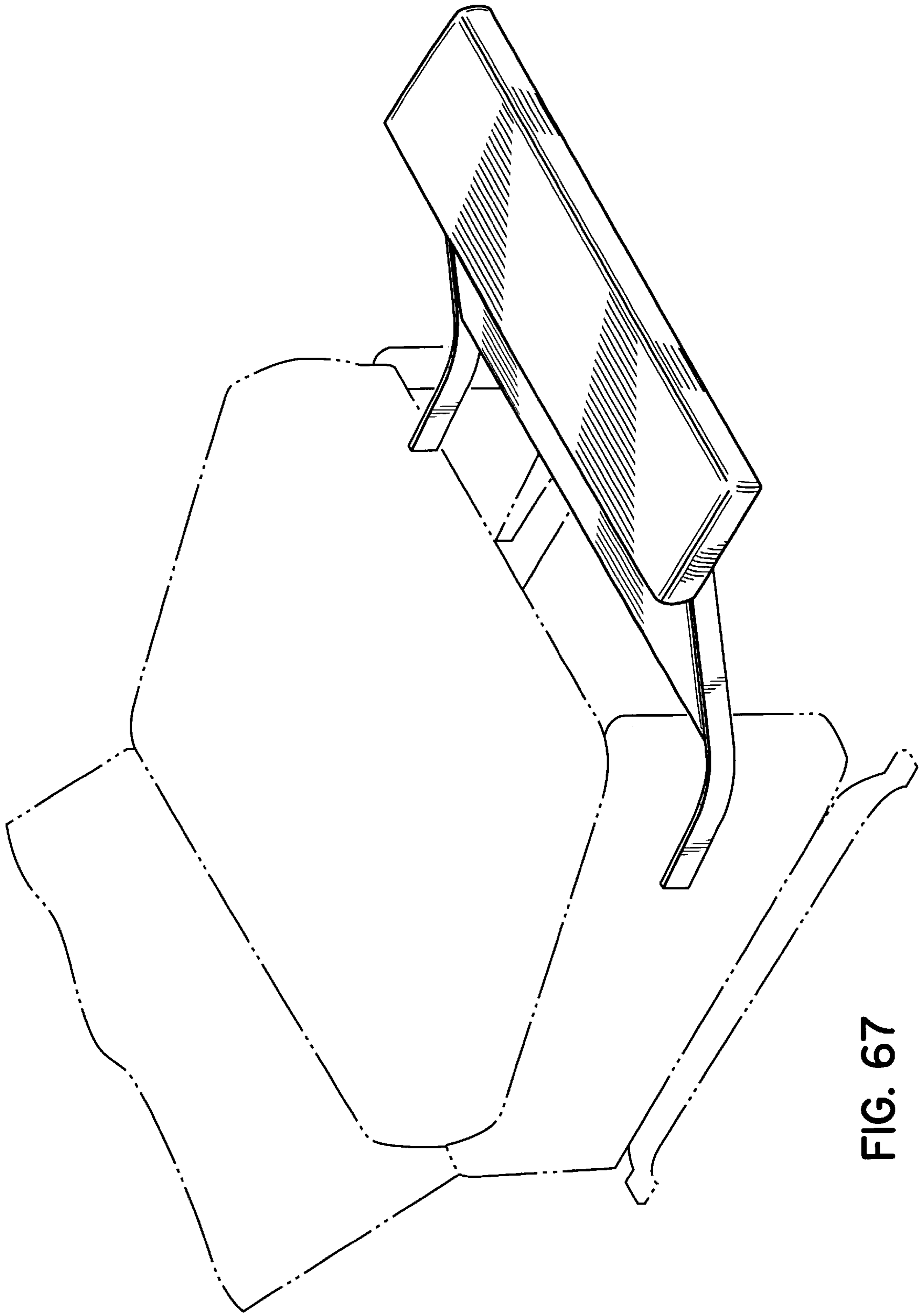

FIG. 67

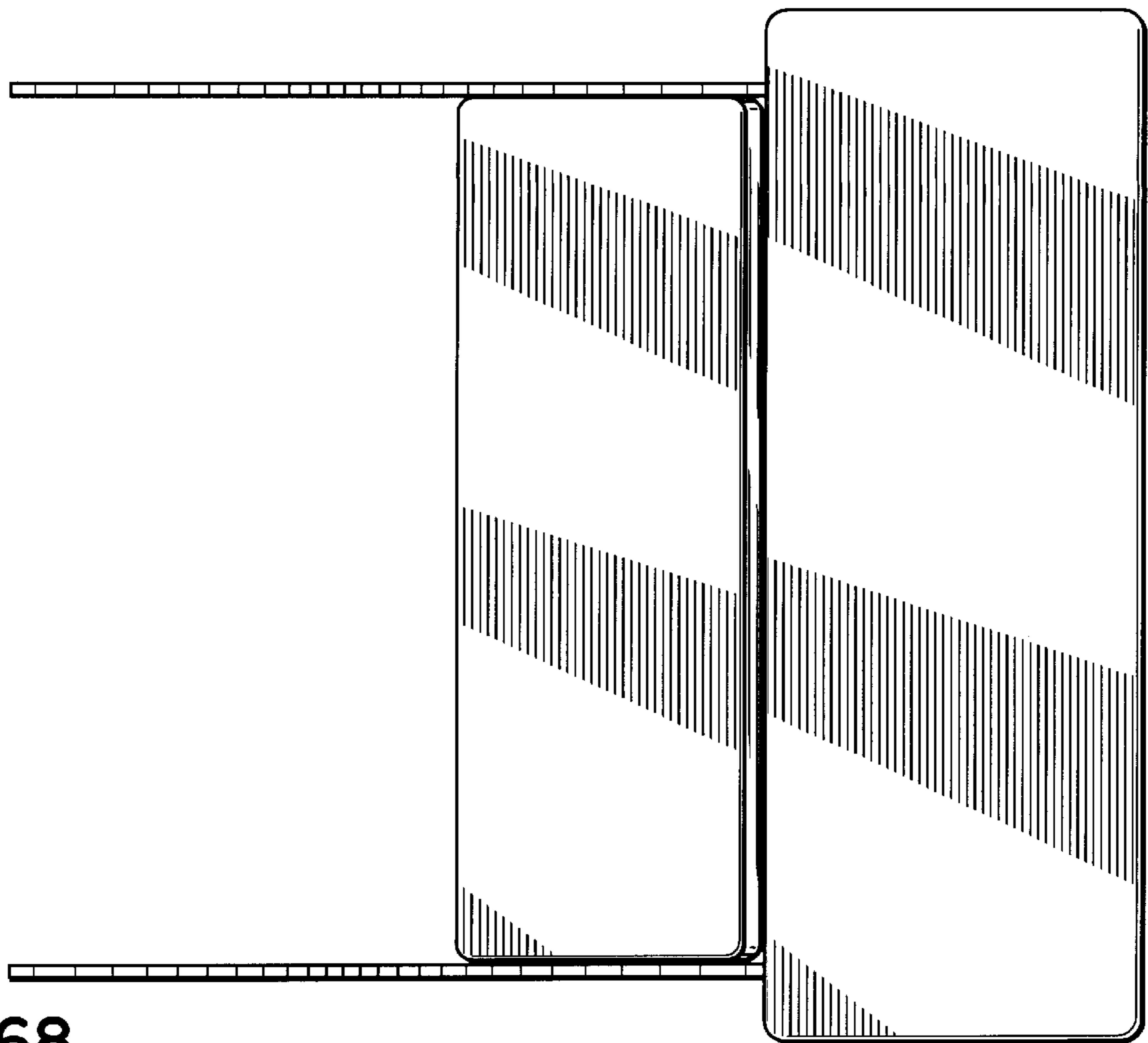

FIG. 68

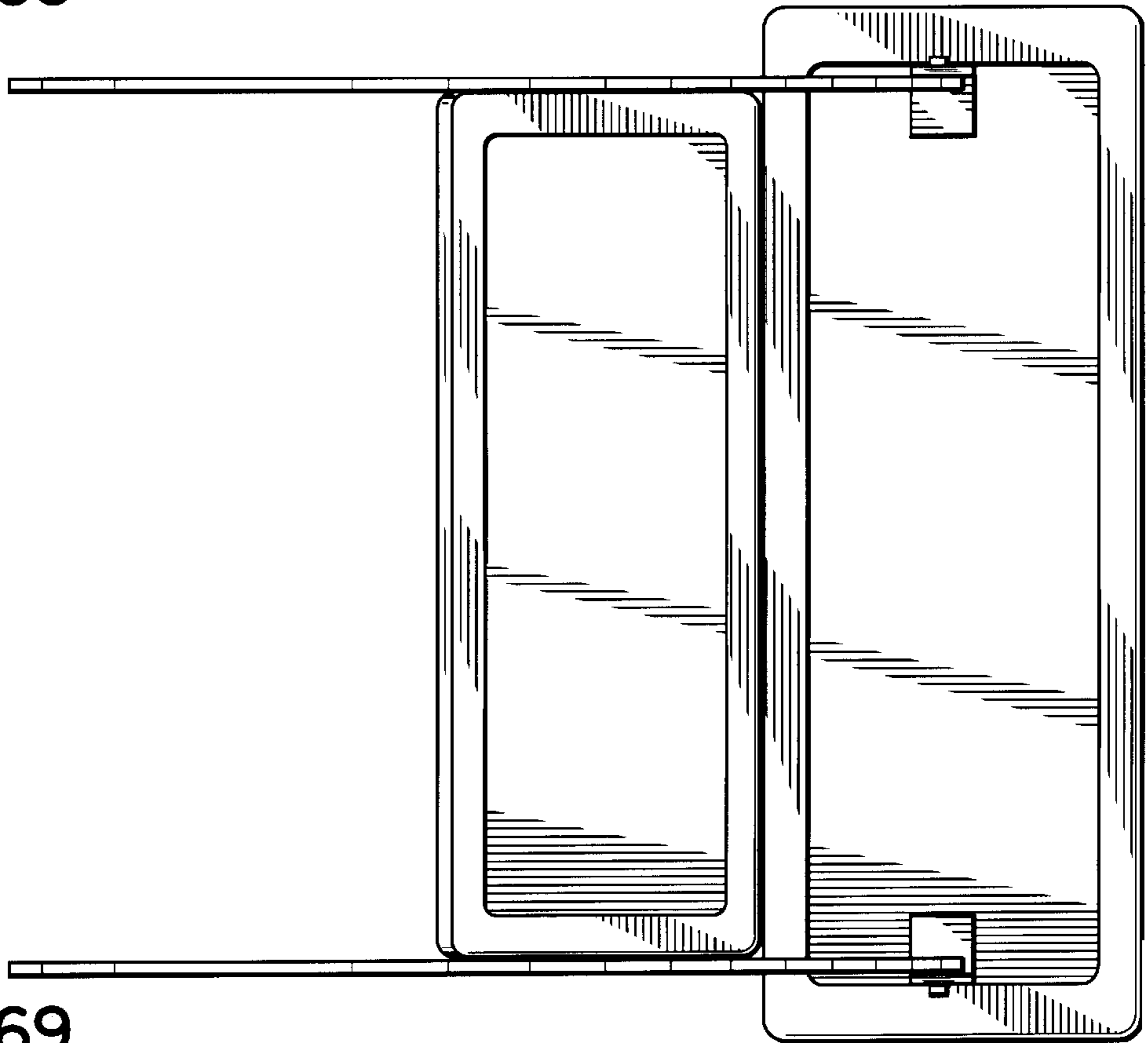

FIG. 69

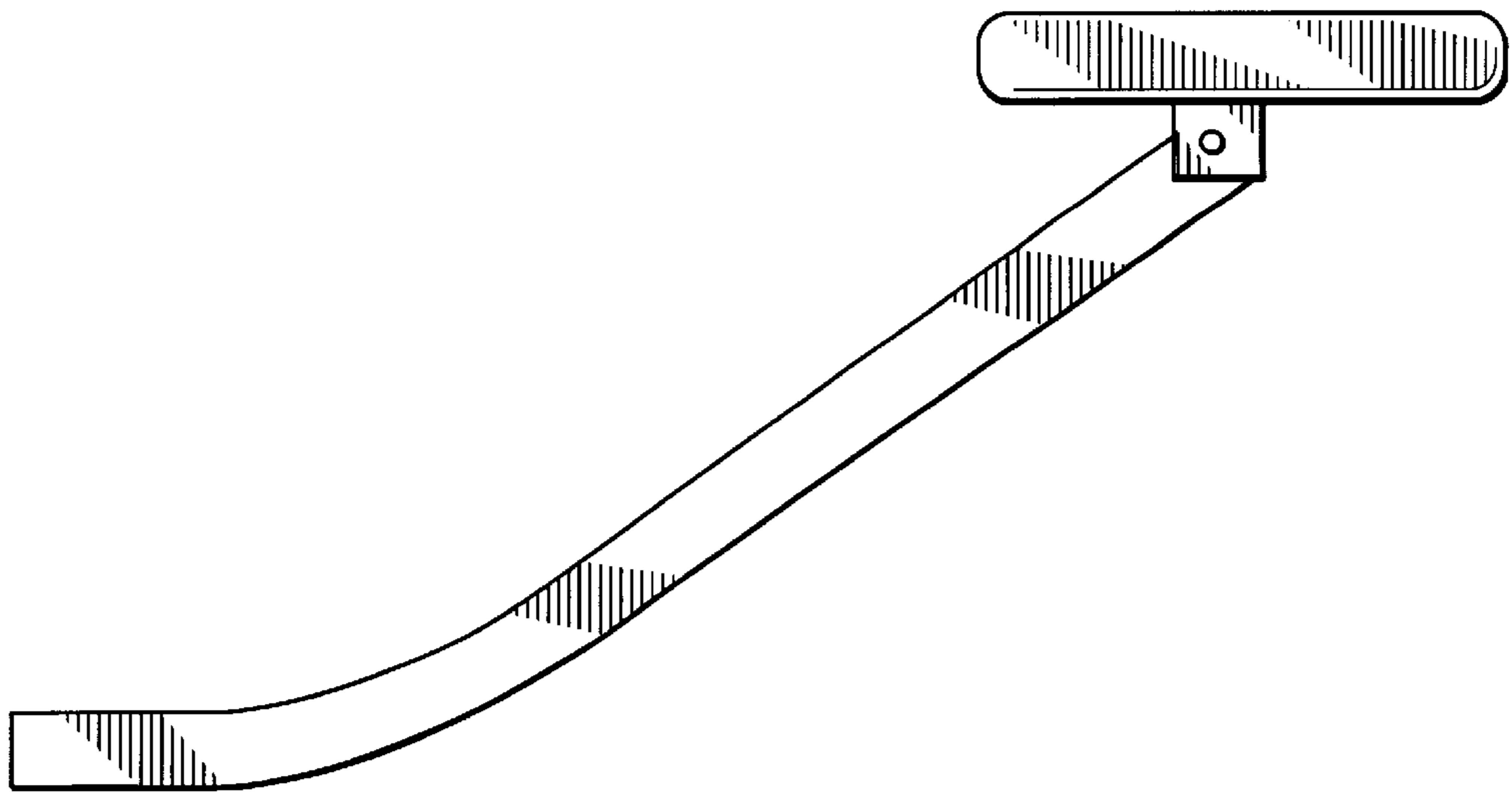

FIG. 70

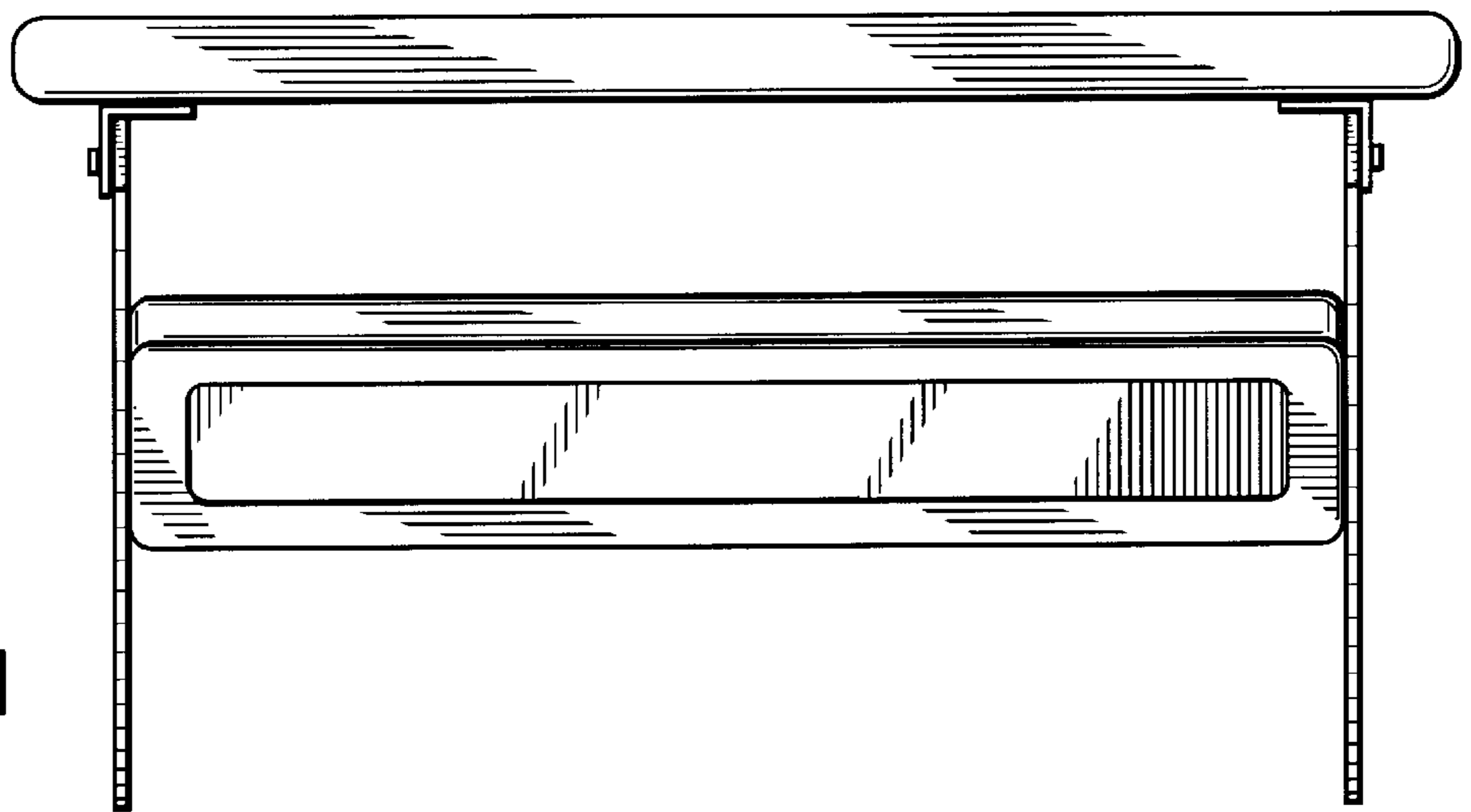

FIG. 71

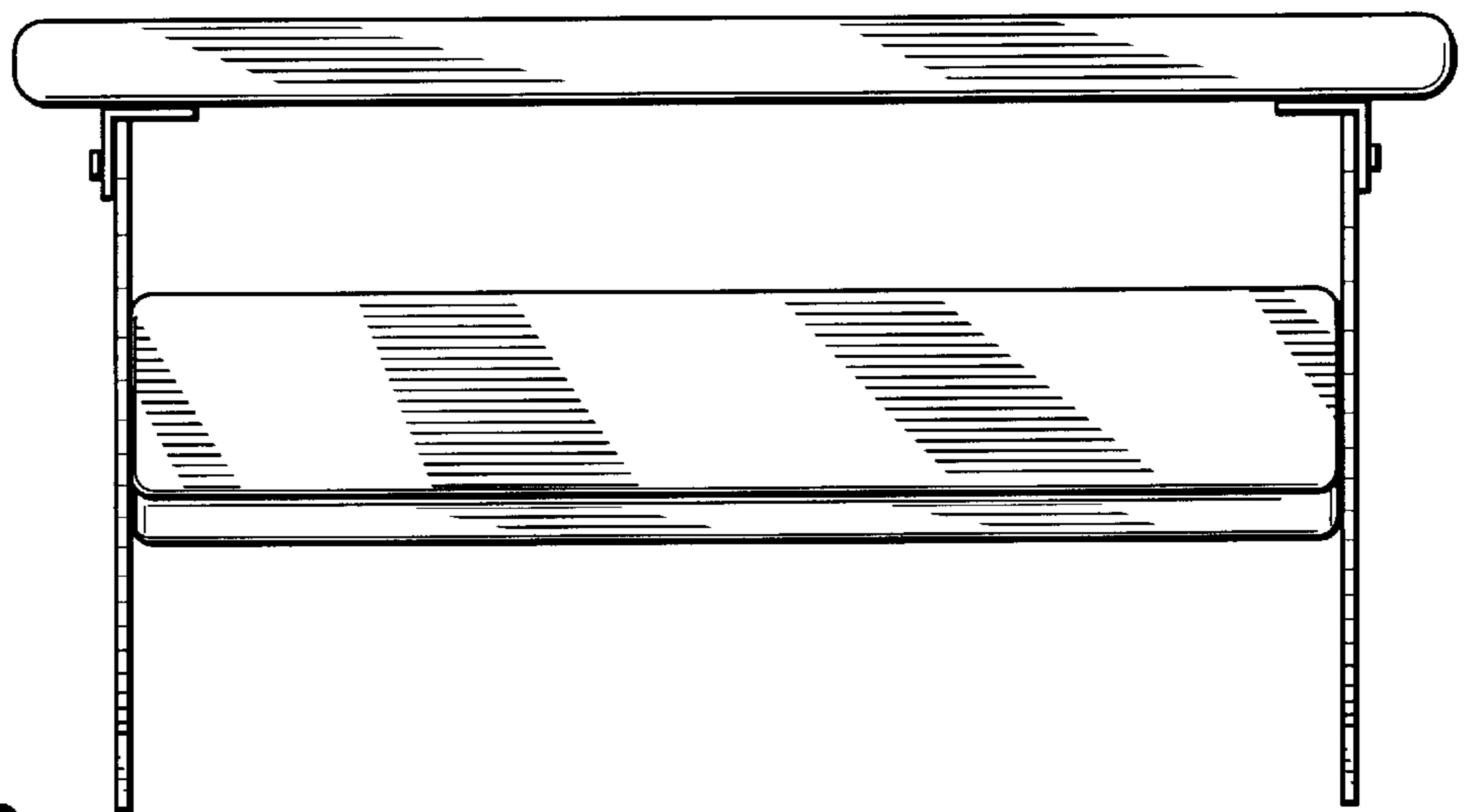

FIG. 72