



US00D456969S

(12) **United States Design Patent** (10) **Patent No.:** **US D456,969 S**
Steinmetz et al. (45) **Date of Patent:** **** May 7, 2002**

(54) **LOTTERY TICKET SCRAPER**

(75) Inventors: **William L. Steinmetz**, Danville, IL (US); **Gordon J. Waligorski**, Delphi; **Robert J. Kennedy**, Lafayette, both of IN (US)

(73) Assignee: **William Steinmetz**, Danville, IL (US)

(**) Term: **14 Years**

(21) Appl. No.: **29/137,724**

(22) Filed: **Feb. 27, 2001**

(51) **LOC (7) Cl.** **08-05**

(52) **U.S. Cl.** **D32/46**

(58) **Field of Search** D32/40, 46; 30/169; 15/236.01, 236.07

(56) **References Cited**

U.S. PATENT DOCUMENTS

D269,944 S	*	8/1983	Young	D32/46 X
D377,250 S	*	1/1997	Bafle, Jr. et al.	D32/46
D380,653 S	*	7/1997	Ayon	D32/46 X
D416,118 S	*	11/1999	Paden	D32/46

* cited by examiner

Primary Examiner—Jennifer Rivard

(74) *Attorney, Agent, or Firm*—Brian D. Smith, P.C.

(57) **CLAIM**

The ornamental design for a lottery ticket scraper, as shown and described.

DESCRIPTION

FIG. 1 is a front perspective view of a first embodiment of the lottery ticket scraper showing our new design;
 FIG. 2 is a side view of thereof, based on FIG. 1.
 FIG. 3 is a side view thereof and a reverse view of FIG. 2;
 FIG. 4 is a top plan view thereof;
 FIG. 5 is a bottom plan view thereof and a reverse view of FIG. 4;
 FIG. 6 is a front elevation view thereof, based on FIG. 1;
 FIG. 7 is a rear elevation view thereof and a reverse view of FIG. 6;
 FIG. 8 is a front perspective view a second embodiment of the lottery ticket scraper showing our new design;
 FIG. 9 is a side view of thereof, based on FIG. 8.
 FIG. 10 is a side view thereof and a reverse view of FIG. 9;
 FIG. 11 is a front elevation view thereof, based on FIG. 8; and,
 FIG. 12 is a rear elevation view thereof and a reverse view of FIG. 11.

1 Claim, 2 Drawing Sheets

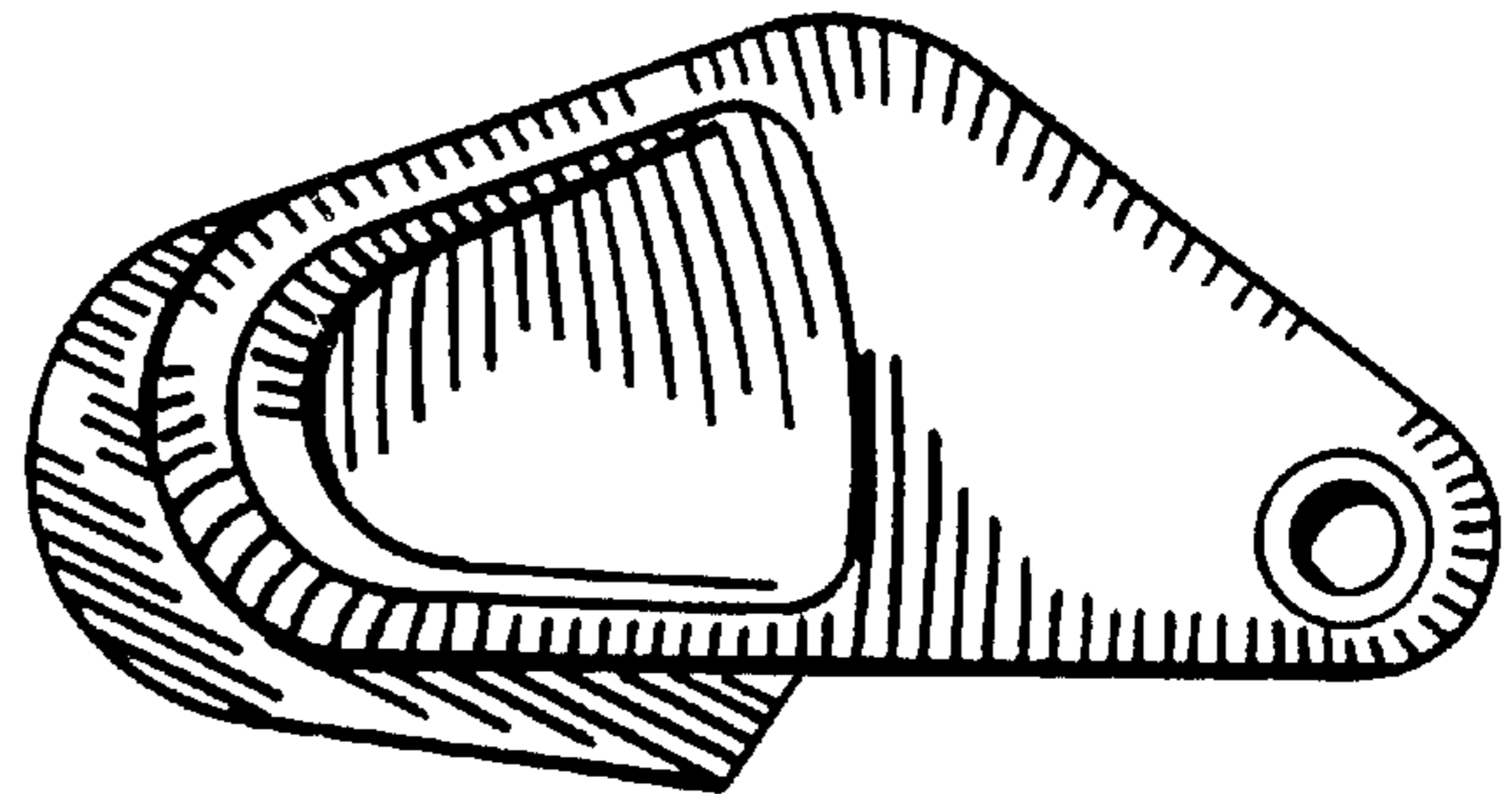
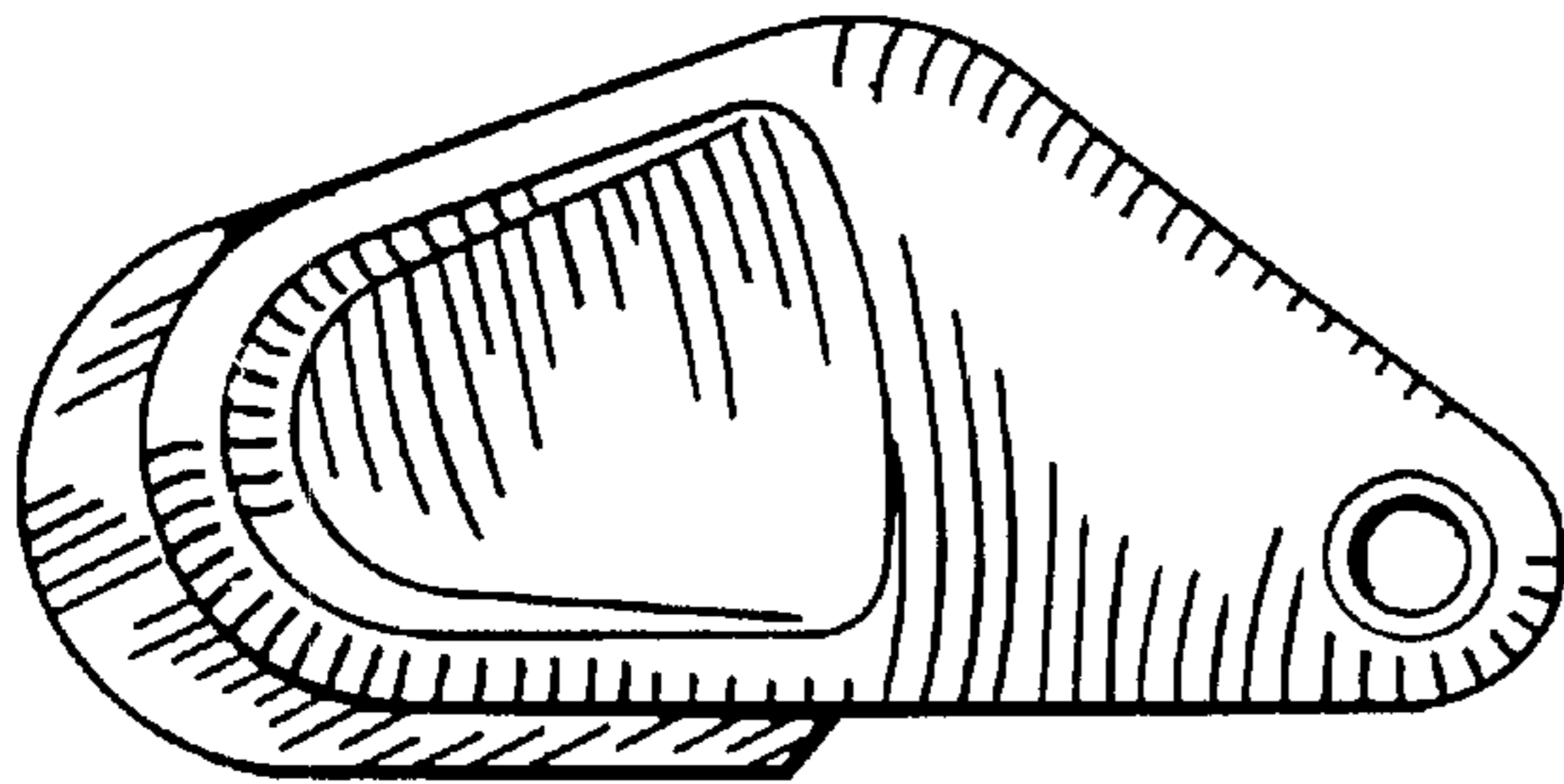

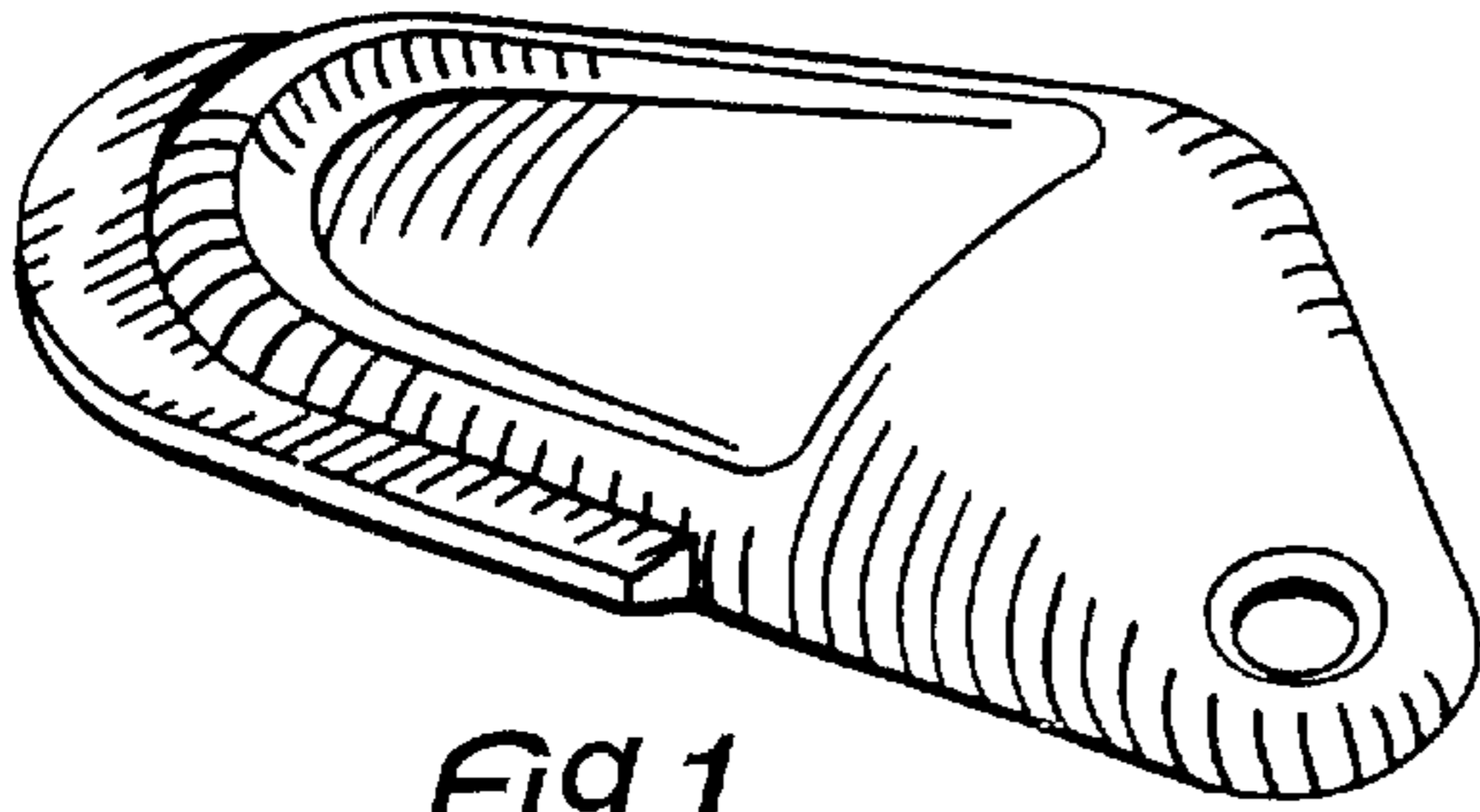

FIG. 1.

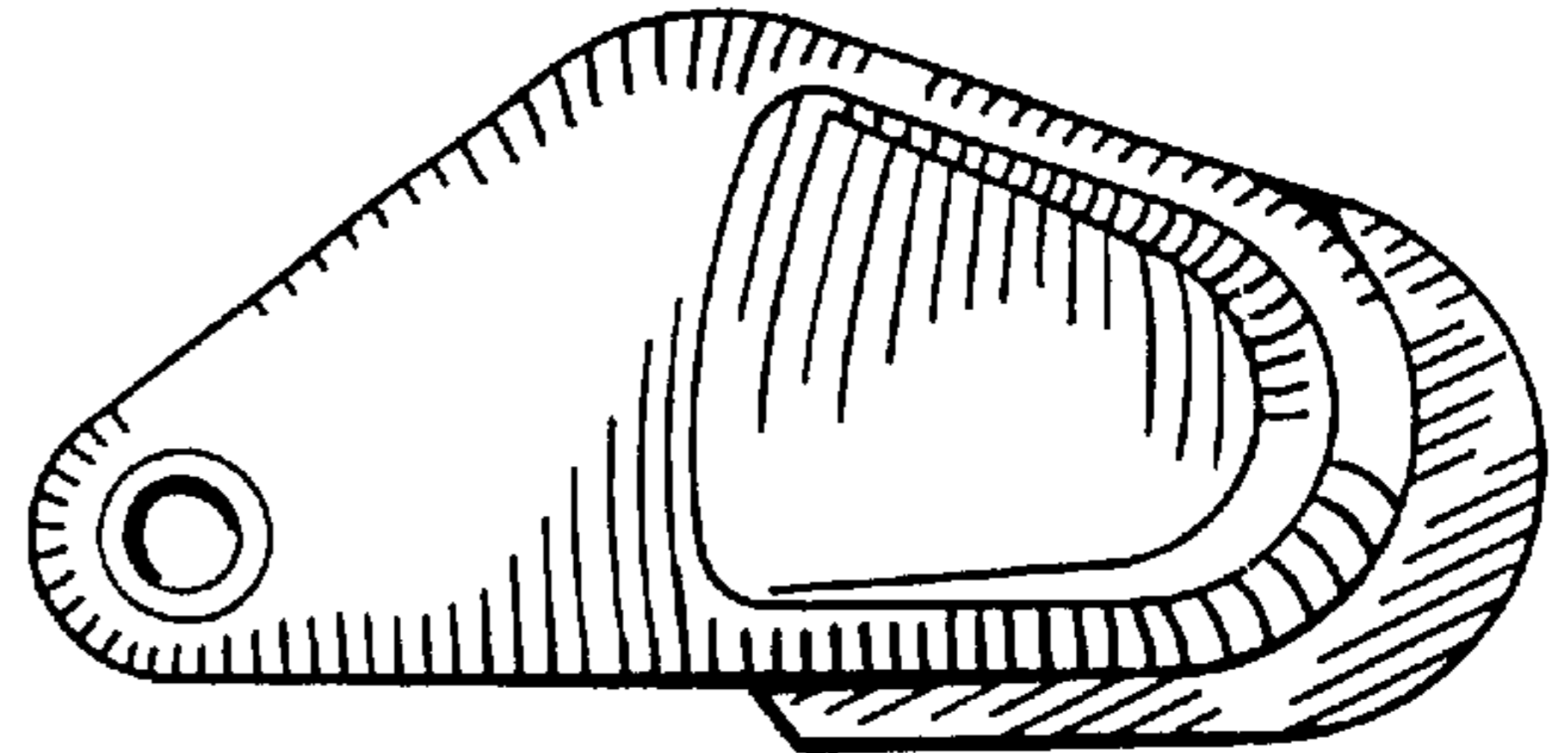

FIG. 2.

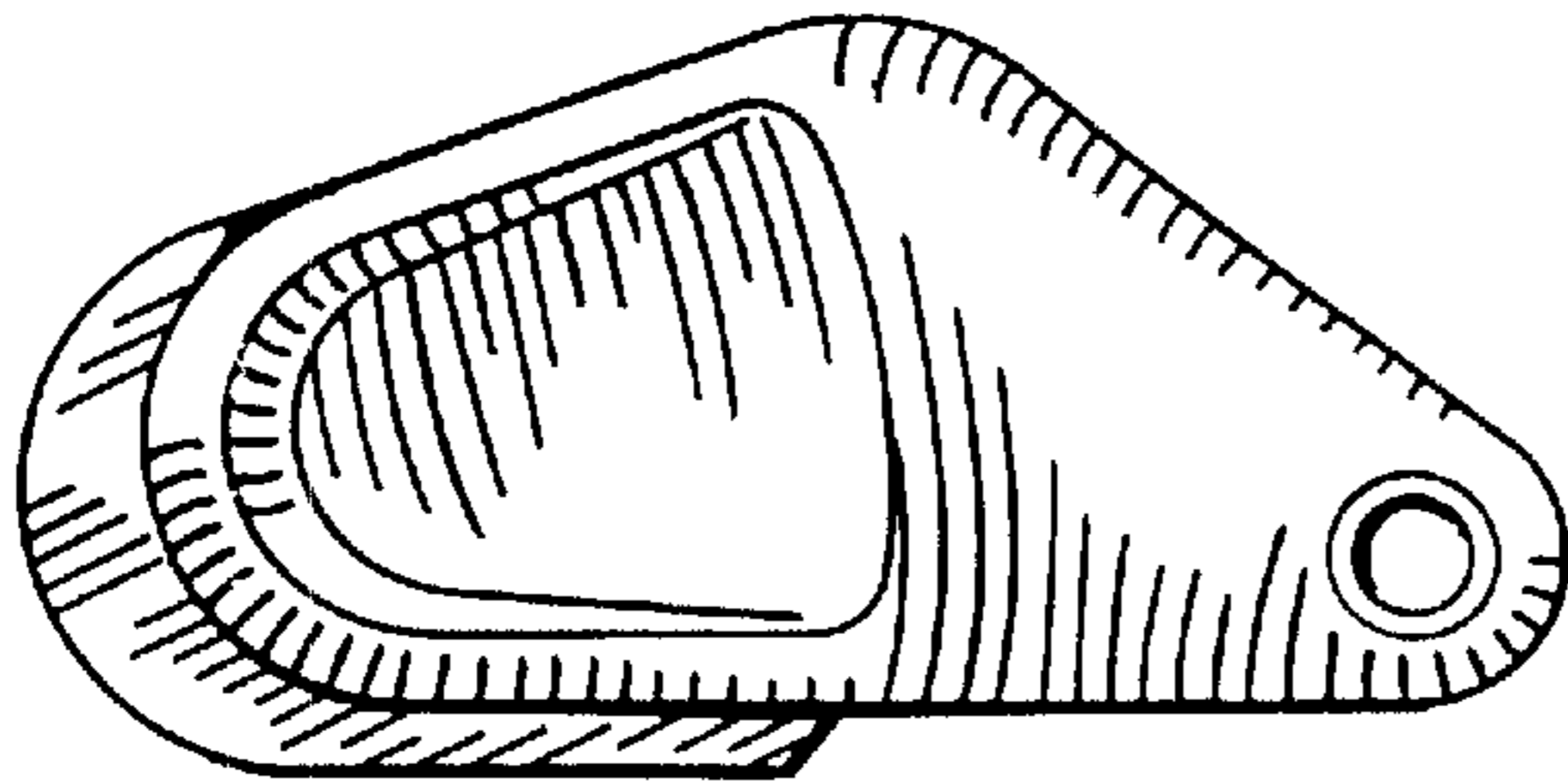

FIG. 3.

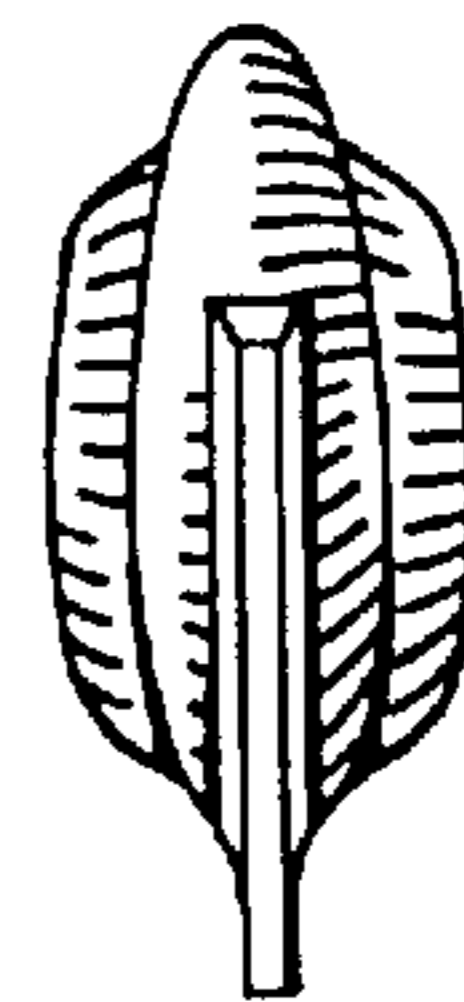

FIG. 6.

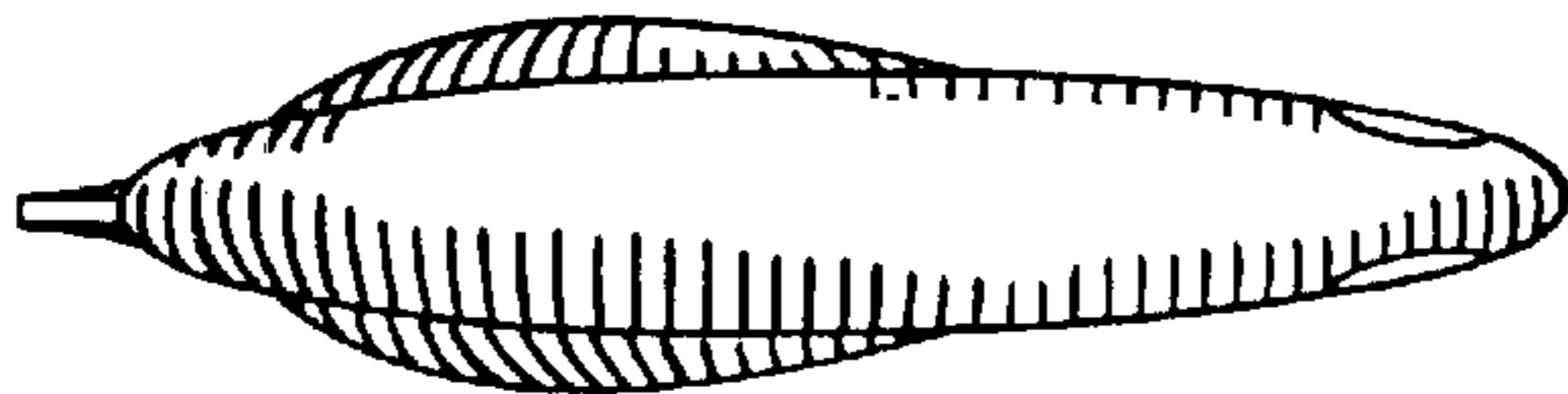

FIG. 4.

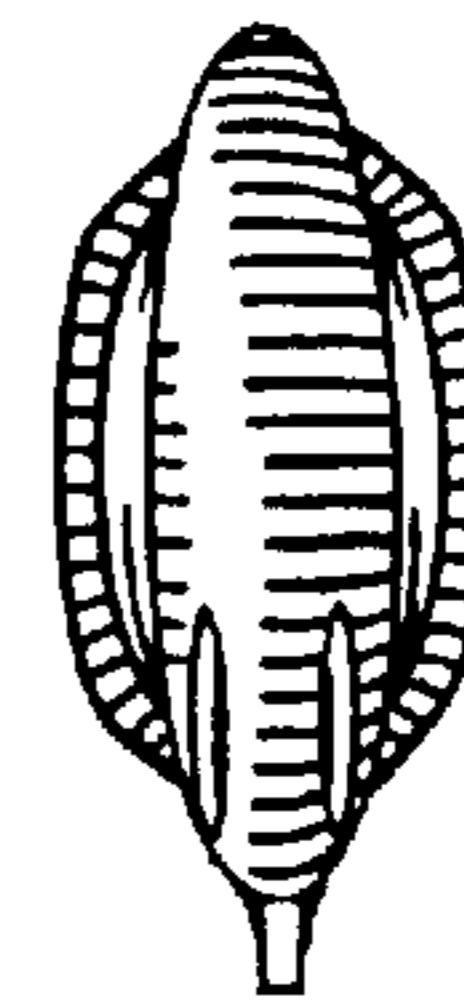

FIG. 7.

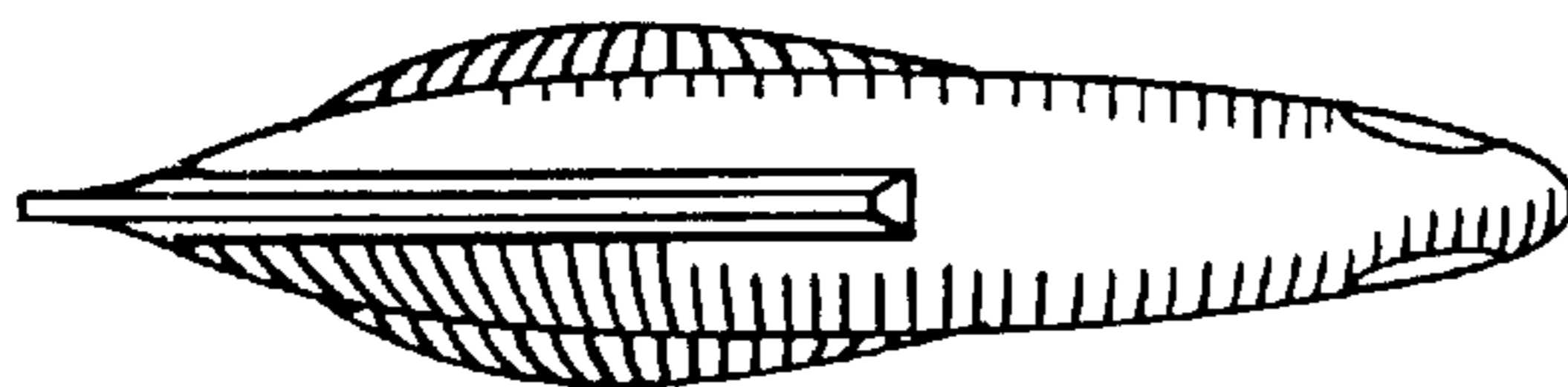

FIG. 5.

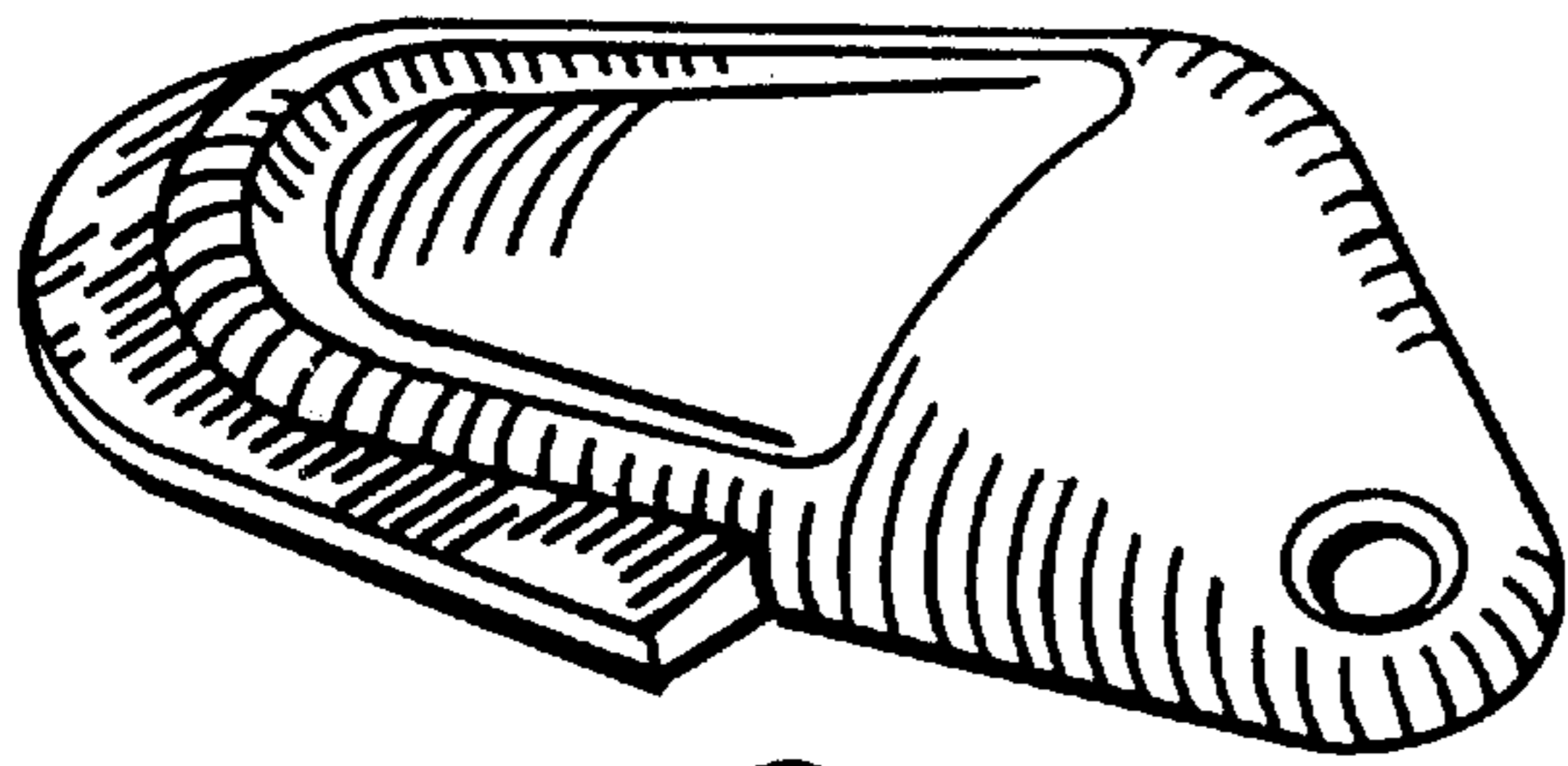

FIG. 8.

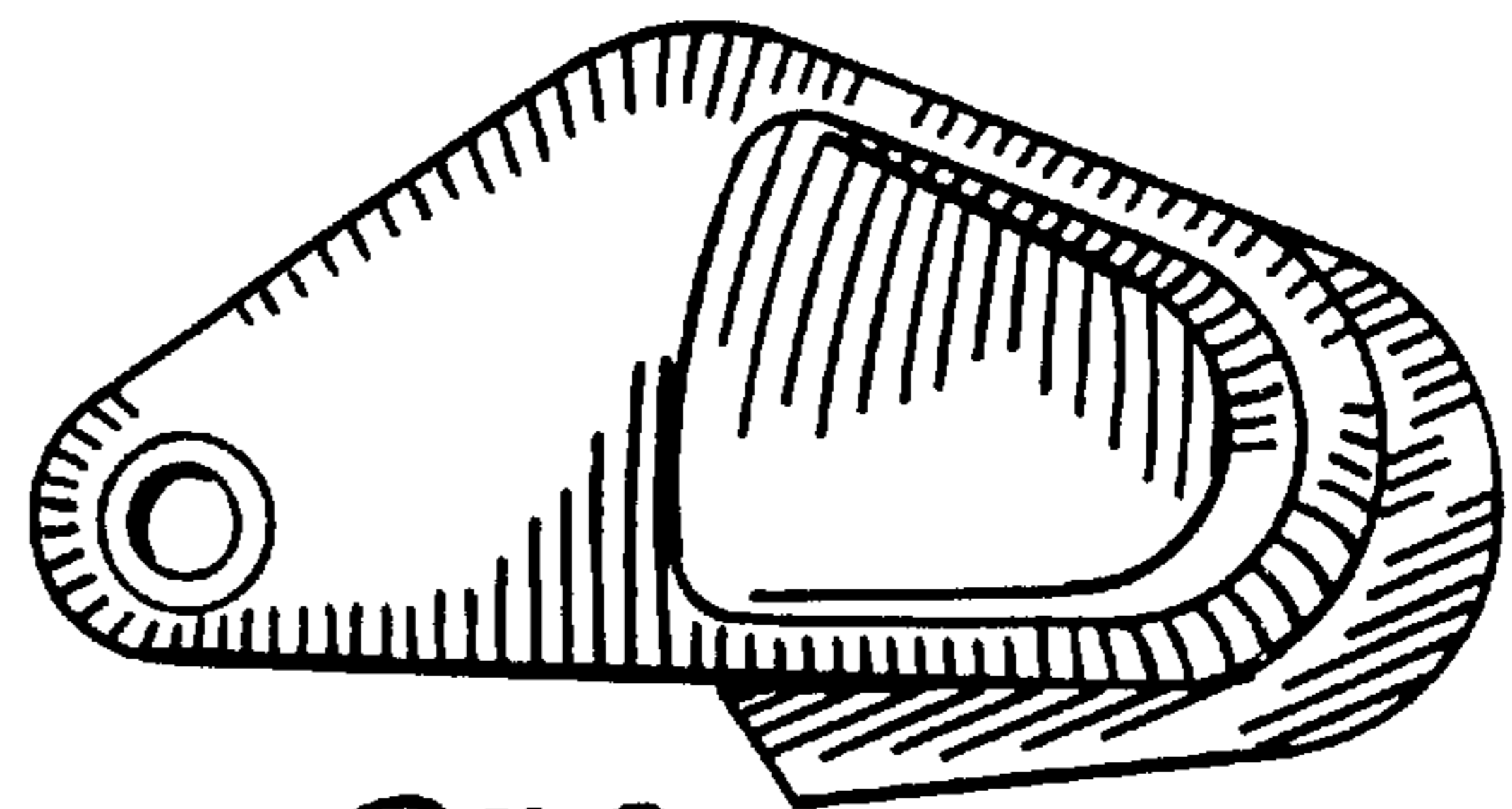

FIG. 9.

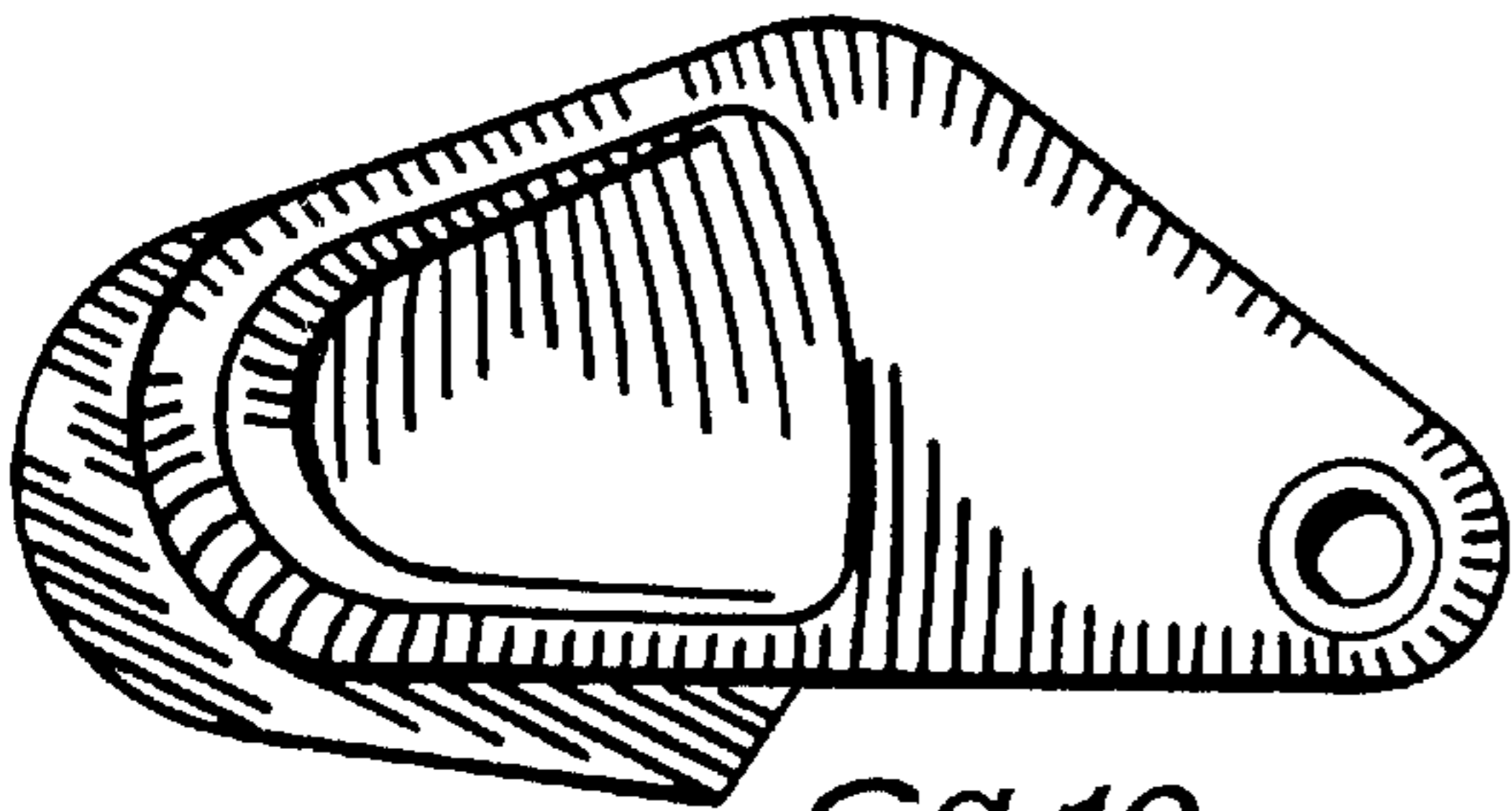

FIG. 10.

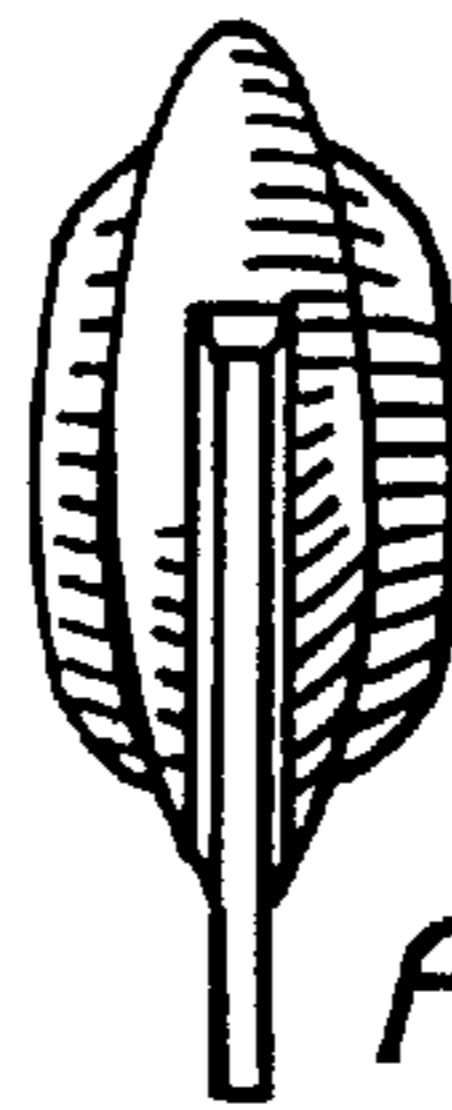

FIG. 11.

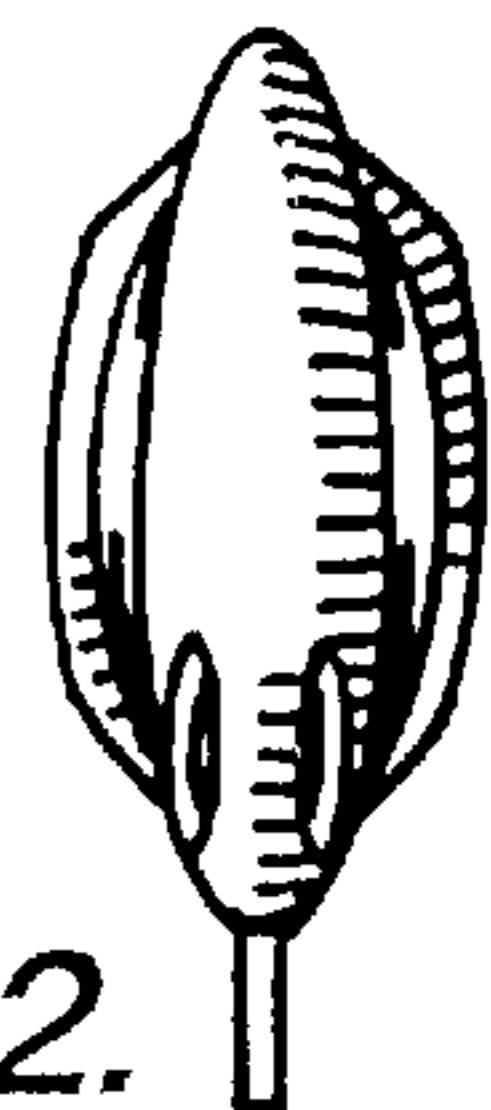

FIG. 12.