



US00D456936S

(12) **United States Design Patent**
Hsu

(10) **Patent No.:** **US D456,936 S**

(45) **Date of Patent:** **** May 7, 2002**

(54) **WALL LAMP**

(75) Inventor: **Peter Hsu**, Taichung (TW)

(73) Assignee: **Dong Guan Bright Yin Huey Lighting Co., Ltd.**, Guang Dong (CN)

(**) Term: **14 Years**

(21) Appl. No.: **29/142,864**

(22) Filed: **Jun. 5, 2001**

(51) **LOC (7) Cl.** **26-03**

(52) **U.S. Cl.** **D26/87**

(58) **Field of Search** D26/72-79, 80-83,
D26/85-91; 362/147, 404-408, 432, 182

(56) **References Cited**

U.S. PATENT DOCUMENTS

D66,189 S * 12/1924 Jaeger
D341,440 S * 11/1993 Hsu D26/87

D440,344 S * 4/2001 DeaArmond D26/87

* cited by examiner

Primary Examiner—Alan P. Douglas

Assistant Examiner—Clare E. Heflin

(74) *Attorney, Agent, or Firm*—Rosenberg, Klein & Lee

(57) **CLAIM**

The ornamental design for a wall lamp, as shown and described.

DESCRIPTION

FIG. 1 is a perspective view of wall lamp showing my new design;

FIG. 2 is a front elevation view thereof;

FIG. 3 is a rear elevation view thereof;

FIG. 4 is a left side elevation view thereof;

FIG. 5 is a right side elevation view thereof;

FIG. 6 is a top plan view thereof; and,

FIG. 7 is a bottom plan view thereof.

1 Claim, 6 Drawing Sheets

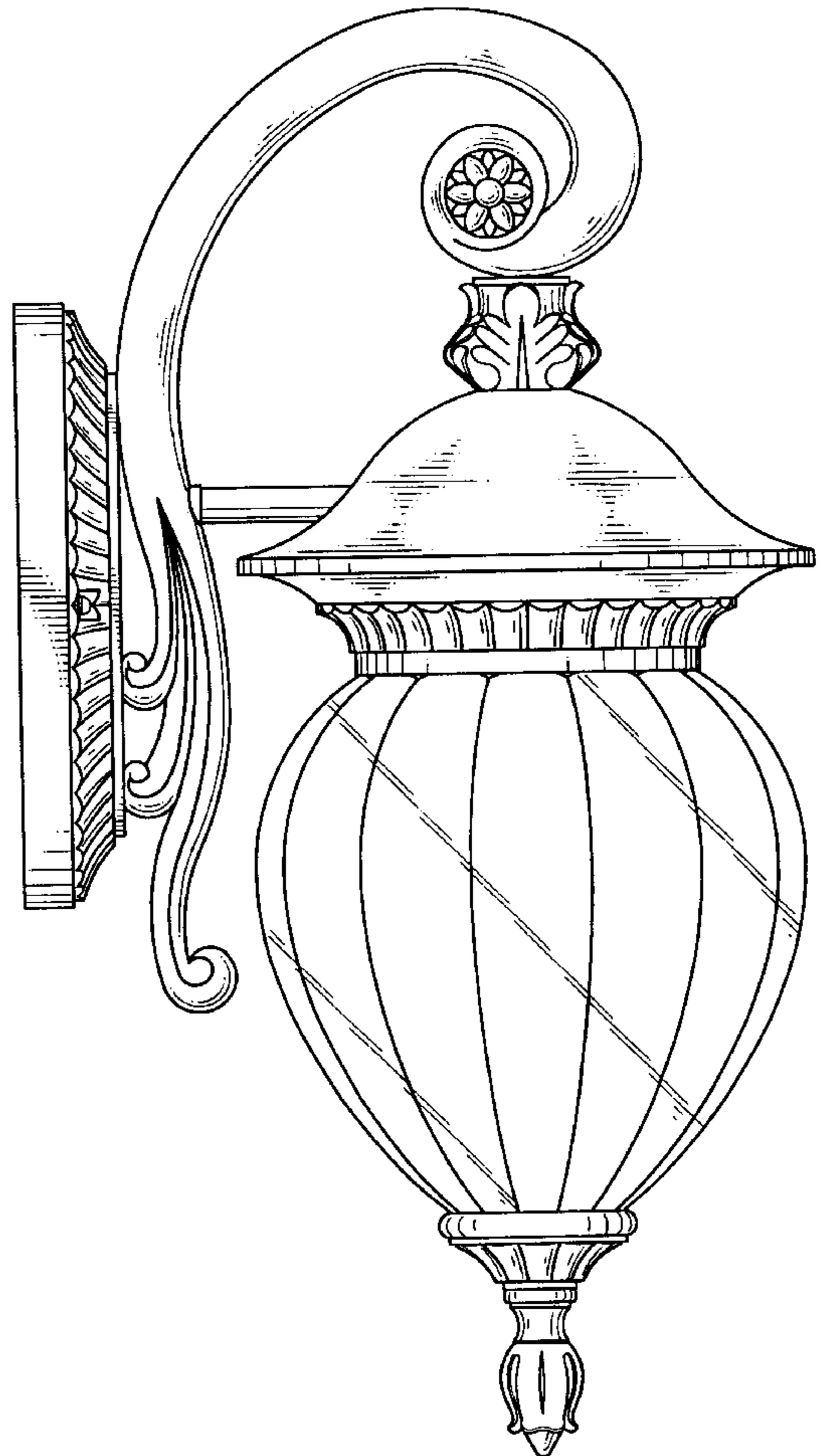
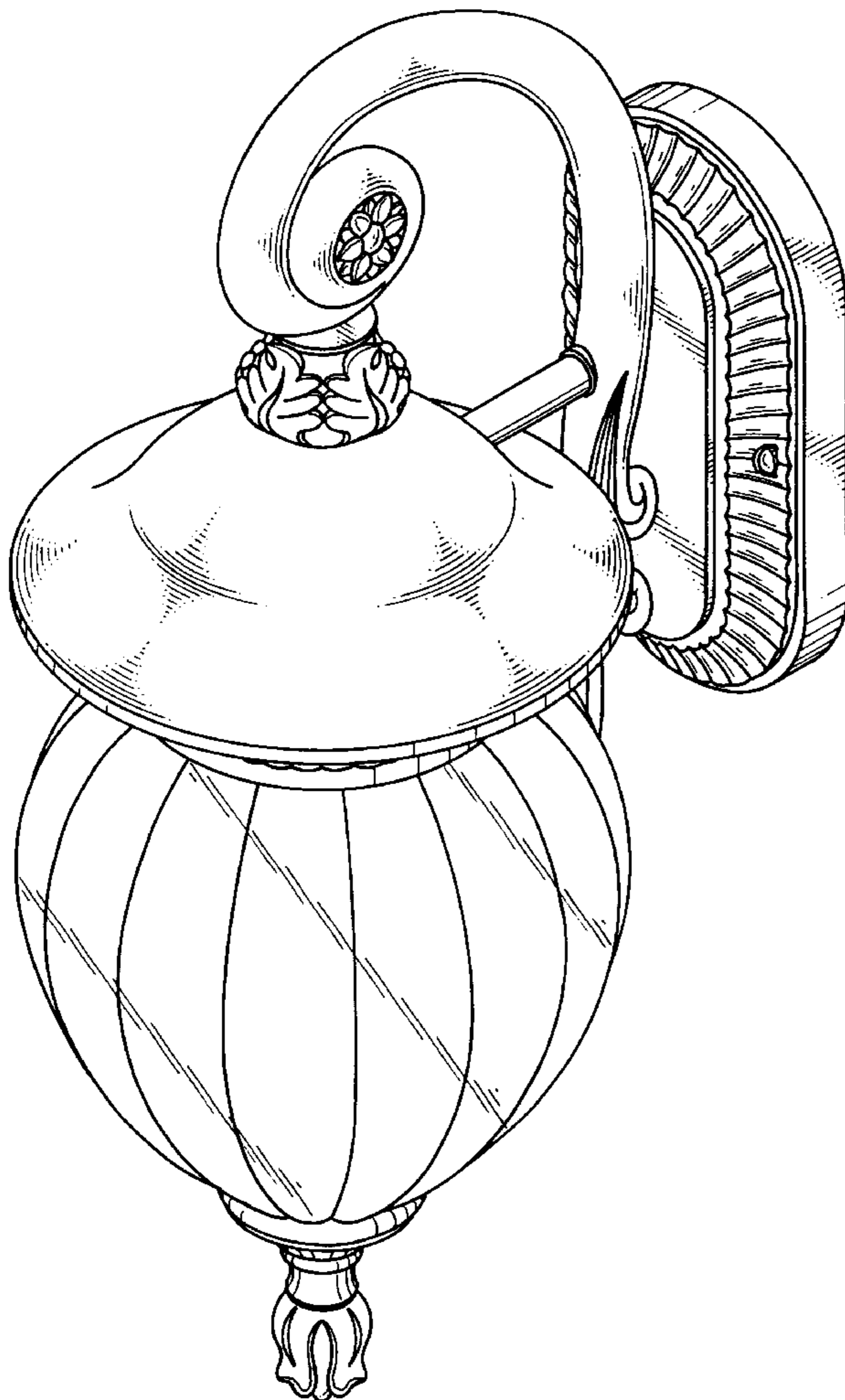

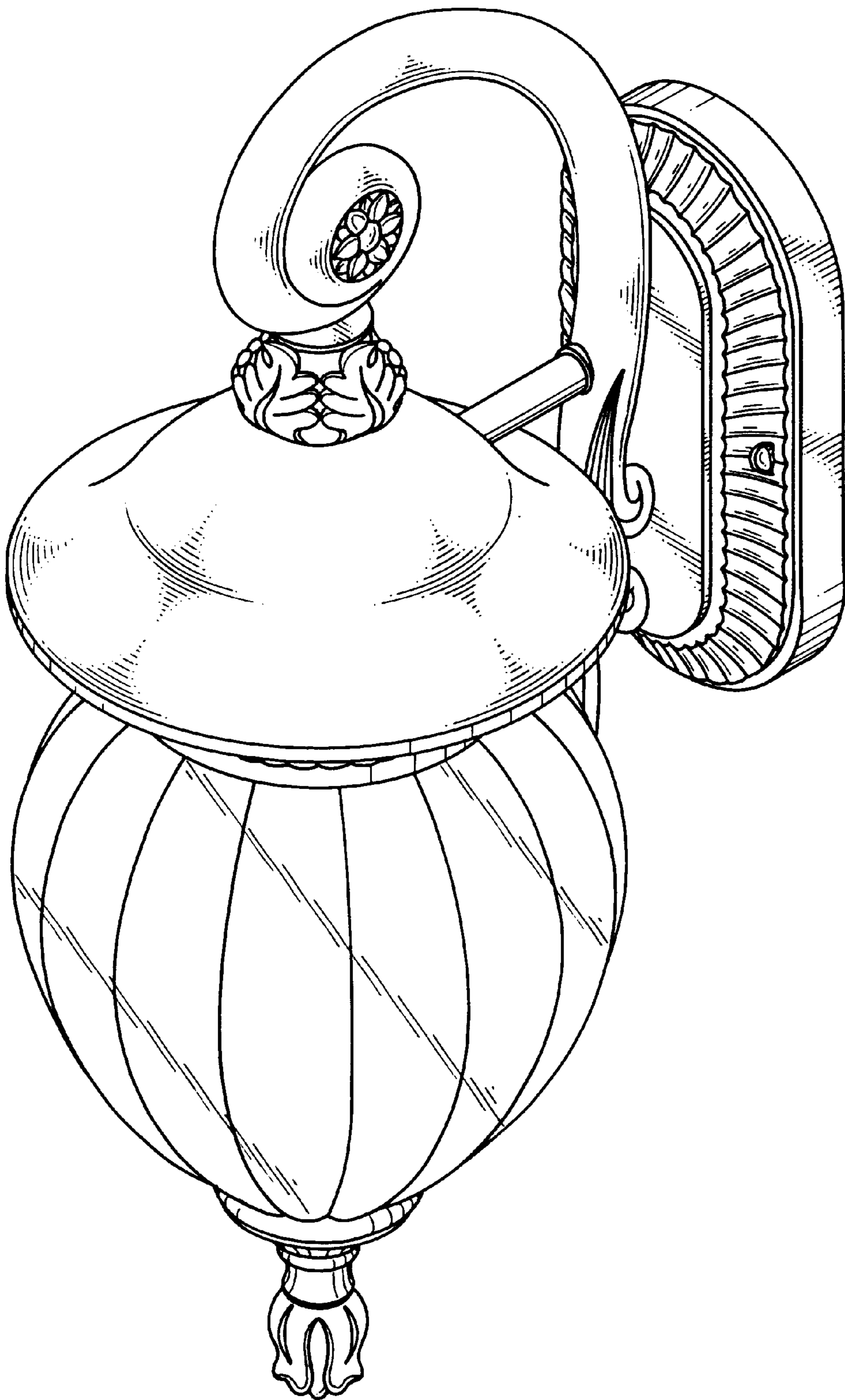

FIG. 1

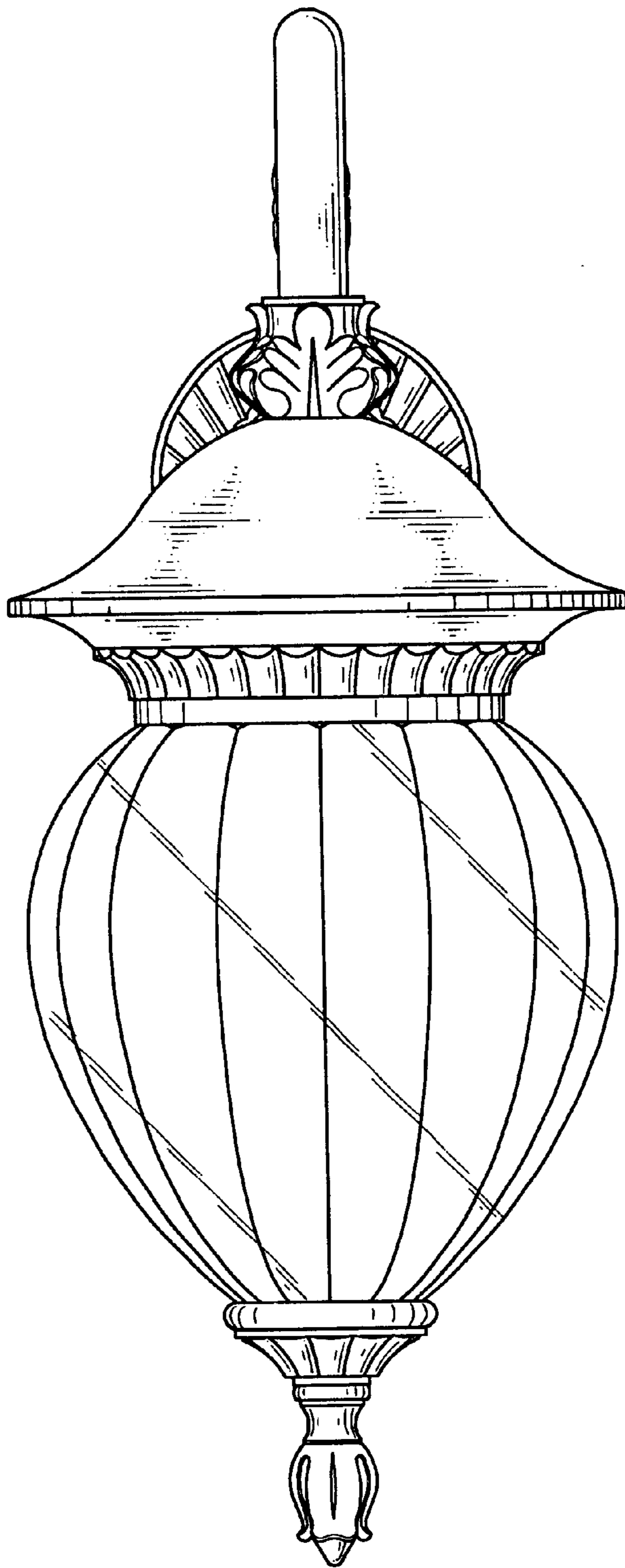

FIG. 2

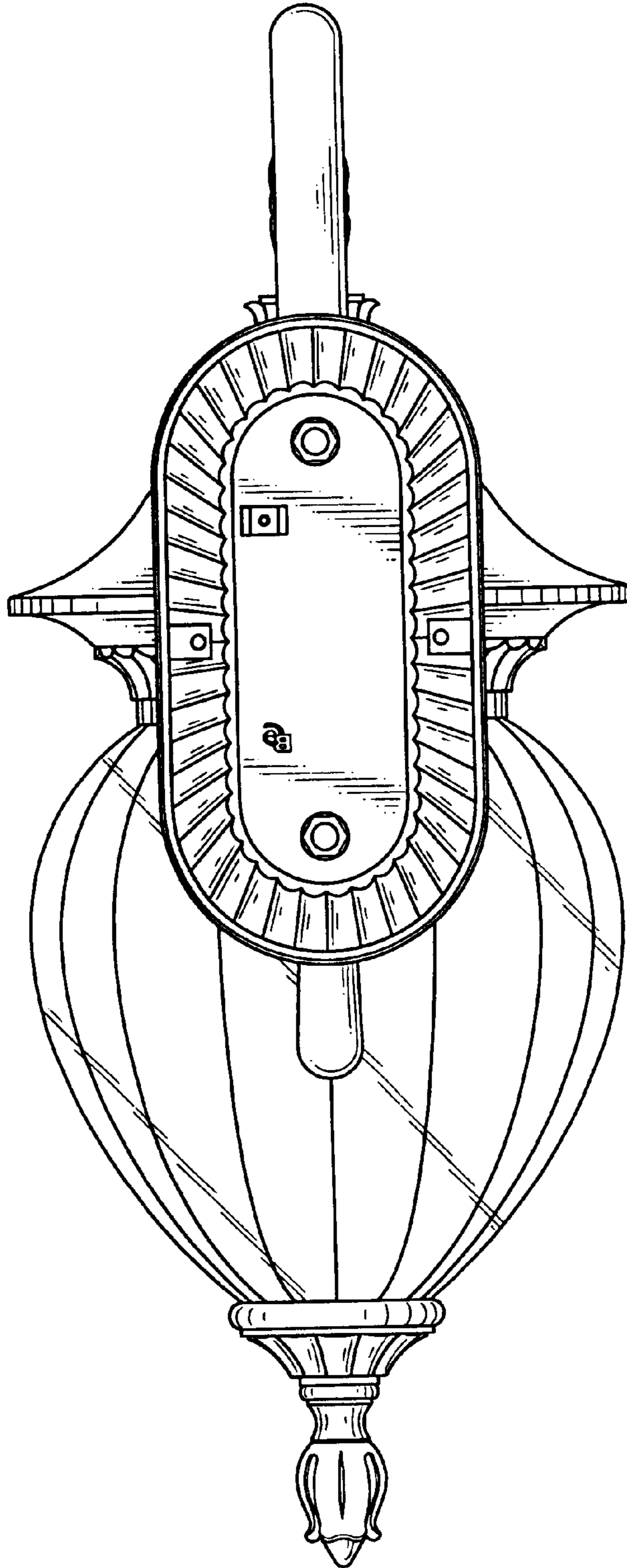

FIG. 3

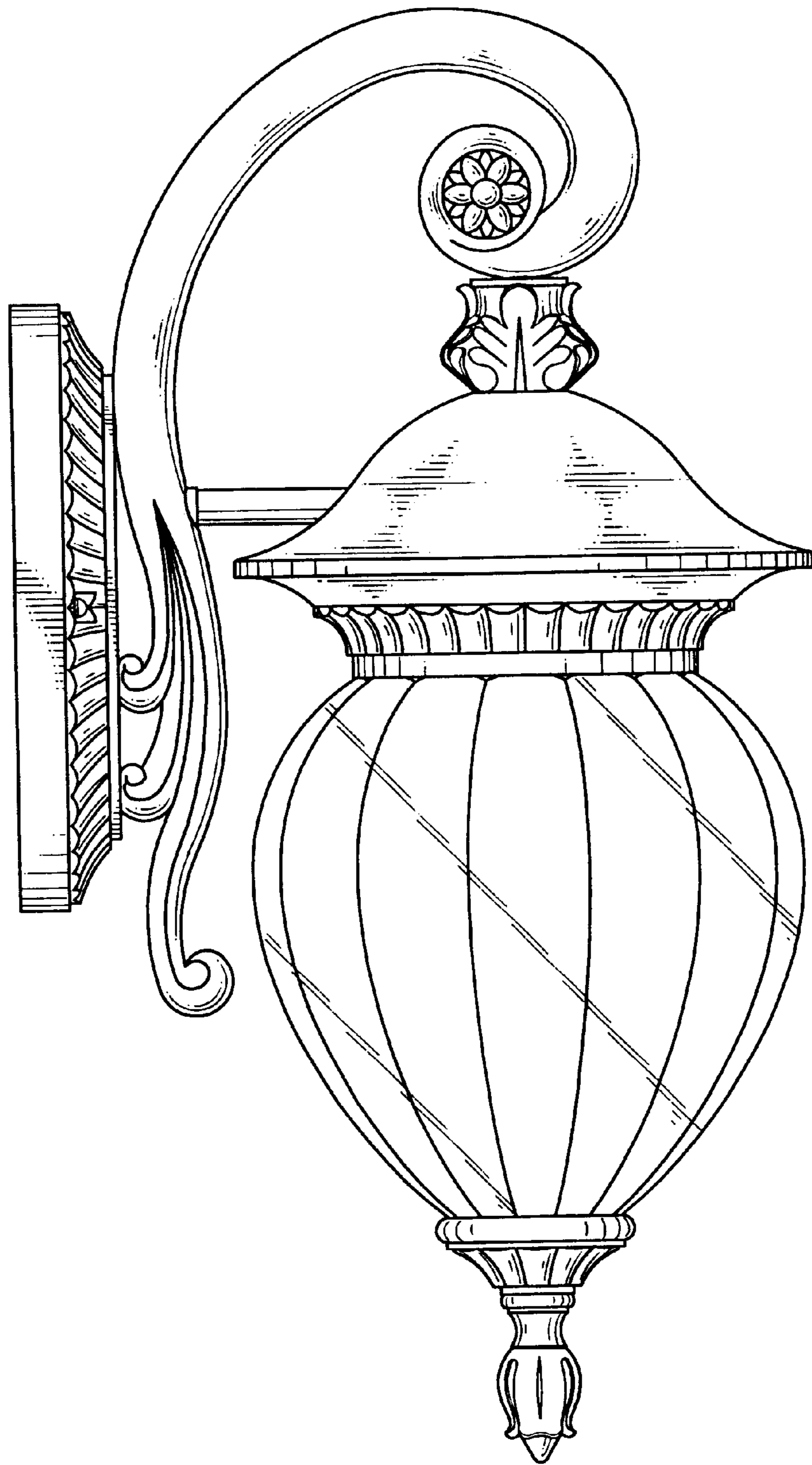

FIG. 4

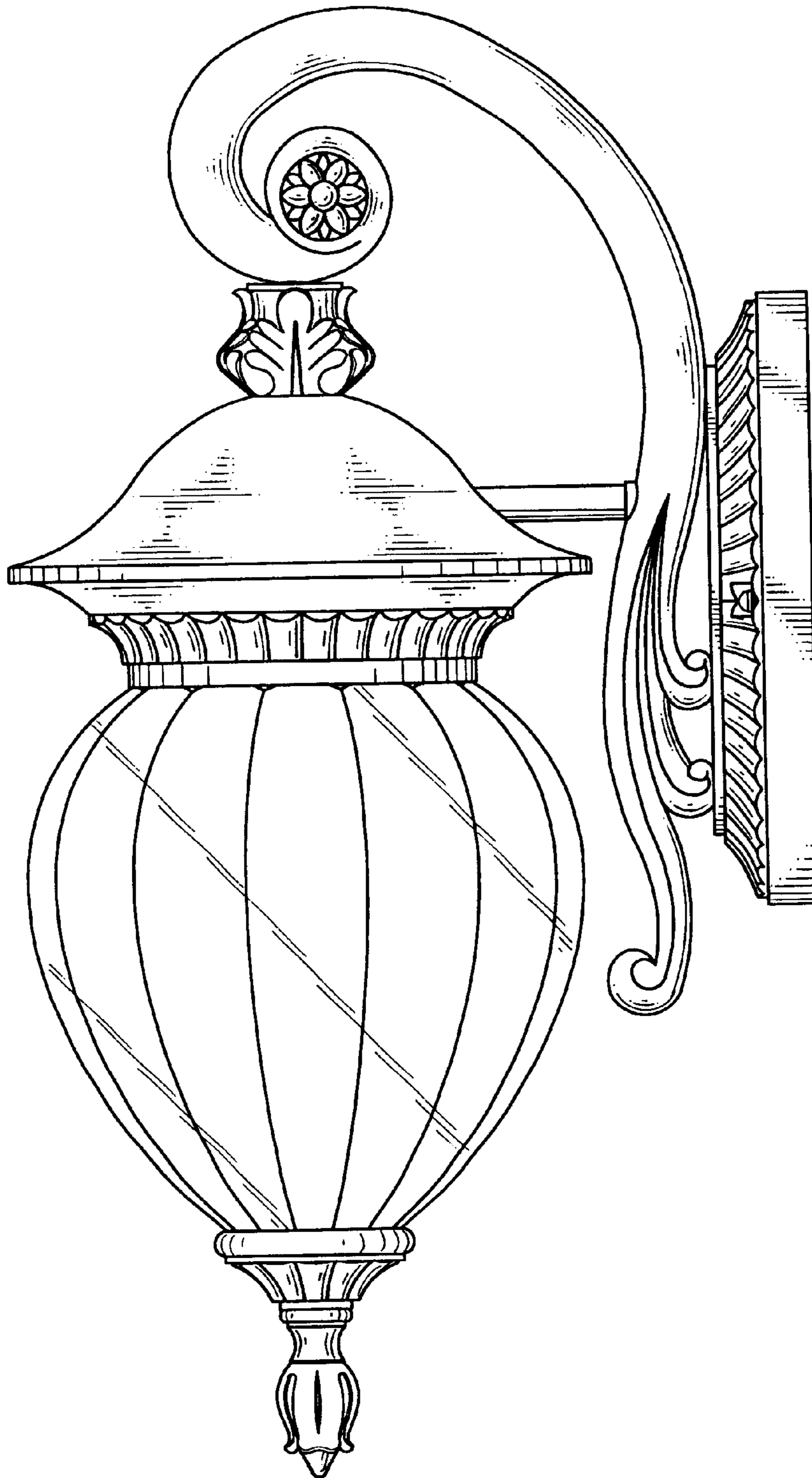

FIG. 5

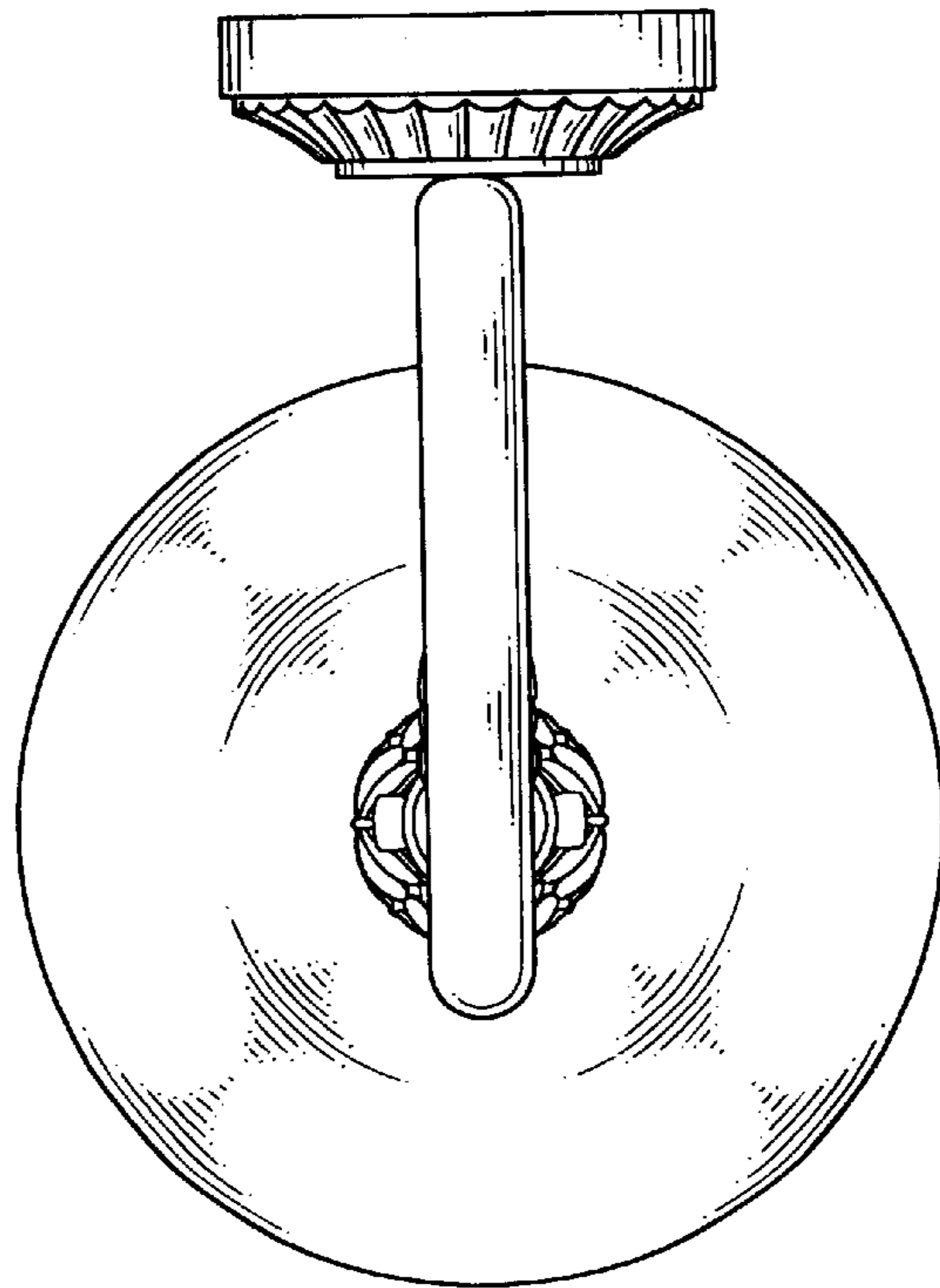

FIG. 6

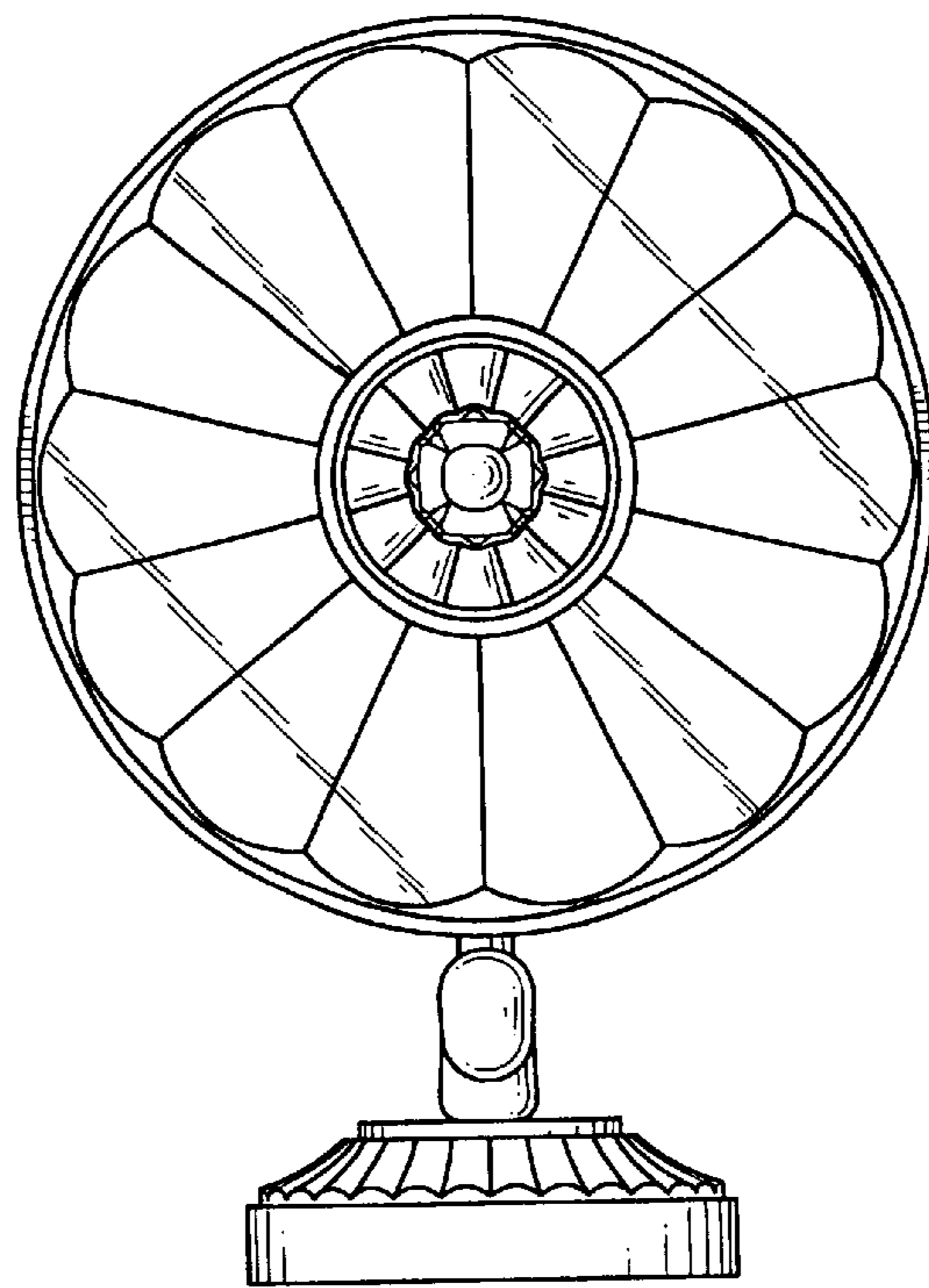

FIG. 7