



US00D456930S

(12) **United States Design Patent**
Russello et al.

(10) **Patent No.:** **US D456,930 S**

(45) **Date of Patent:** **** May 7, 2002**

(54) **LUMINAIRE**

(75) Inventors: **Thomas Russello**, Freehold; **Ann Greene**, Cranford, both of NJ (US)

(73) Assignee: **Genlyte Thomas Group LLC**,
Louisville, KY (US)

(**) Term: **14 Years**

(21) Appl. No.: **29/141,213**

(22) Filed: **May 1, 2001**

(51) **LOC (7) Cl.** **26-03**

(52) **U.S. Cl.** **D26/85**

(58) **Field of Search** D26/72-83, 85-92,
D26/135, 136, 128; 362/147, 432, 404-408,
182, 351, 362, 363

(56) **References Cited**

U.S. PATENT DOCUMENTS

| | | | | | | | |
|-----------|---|---|---------|-----------------|-------|--------|---|
| 2,732,484 | A | * | 1/1956 | Lipscomb | | D26/76 | X |
| D267,516 | S | * | 1/1983 | Rambusch et al. | | D26/72 | |
| D338,980 | S | * | 8/1993 | Dieperink | | D26/87 | |
| D415,304 | S | * | 10/1999 | Brown | | D26/87 | |
| D440,692 | S | * | 4/2001 | Janos et al. | | D26/87 | |
| D444,258 | S | * | 6/2001 | Bradford et al. | | D26/87 | |
| D446,340 | S | * | 8/2001 | Bradford et al. | | D26/87 | |

OTHER PUBLICATIONS

Thomas Industries Inc. Brochure/McPhilben 100 line Performance Sconces (c) 2000.*

* cited by examiner

Primary Examiner—Alan P. Douglas

Assistant Examiner—Clare E. Heflin

(74) *Attorney, Agent, or Firm*—Jeffrey A. Haeblerlin; Middleton Reutlinger

(57) **CLAIM**

The ornamental design for a luminaire, as shown and described herein.

DESCRIPTION

FIG. 1 is a top perspective view of a luminaire showing our design.

FIG. 2 is a front elevation view thereof.

FIG. 3 is a rear elevation view thereof.

FIG. 4 is a side elevation view thereof.

FIG. 5 is a side elevation from the opposite side of FIG. 4 of the luminaire of FIG. 1.

FIG. 6 is a top plan view thereof; and,

FIG. 7 is a bottom plan view thereof.

The broken lines shown in the figures show a mounting bracket, which is illustrative only and forms no part of the claimed design. Additionally, the luminaire shown is oriented for downward illumination. However, the luminaire may be mounted in alternate orientations without variation of the design disclosed herein.

1 Claim, 6 Drawing Sheets

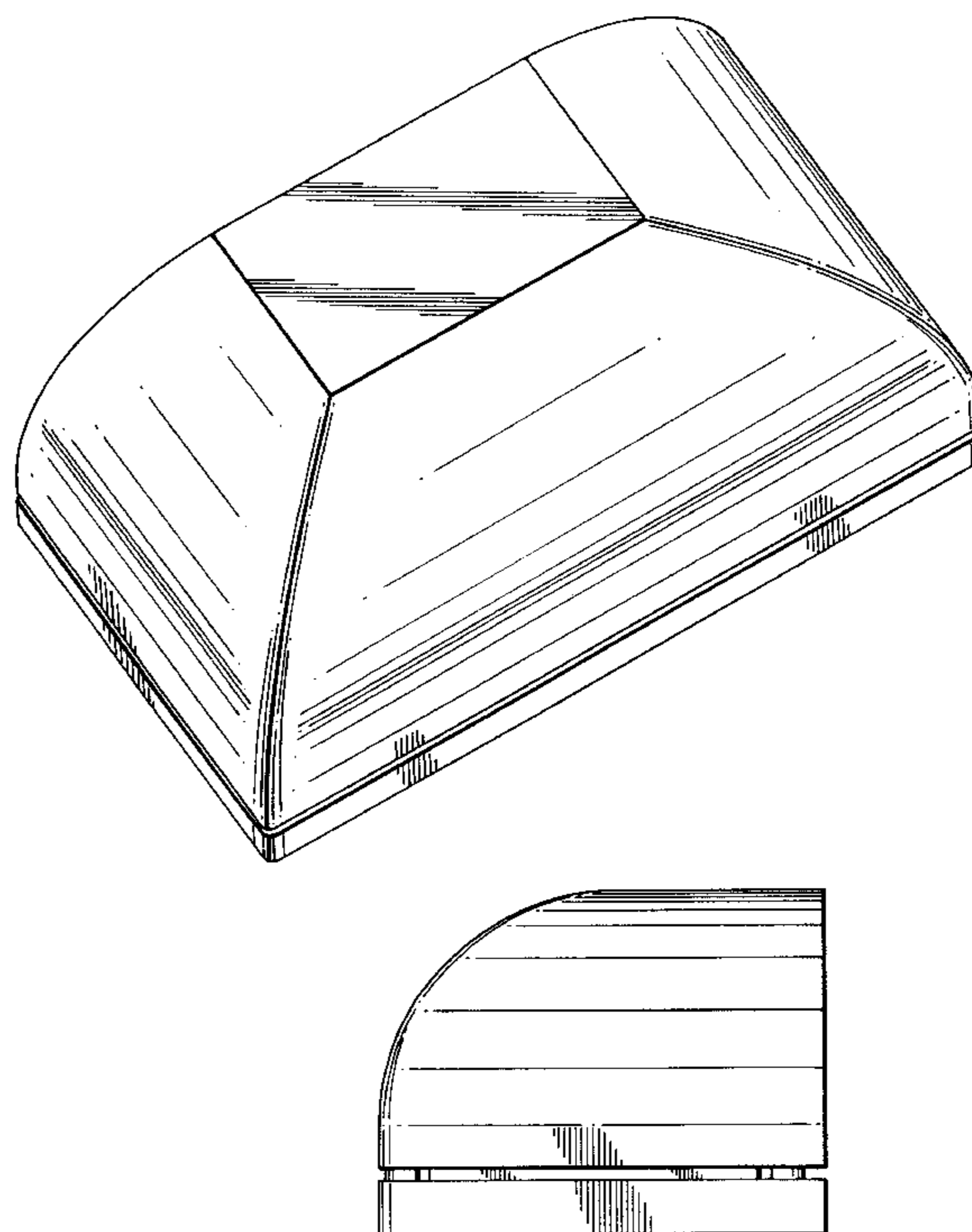

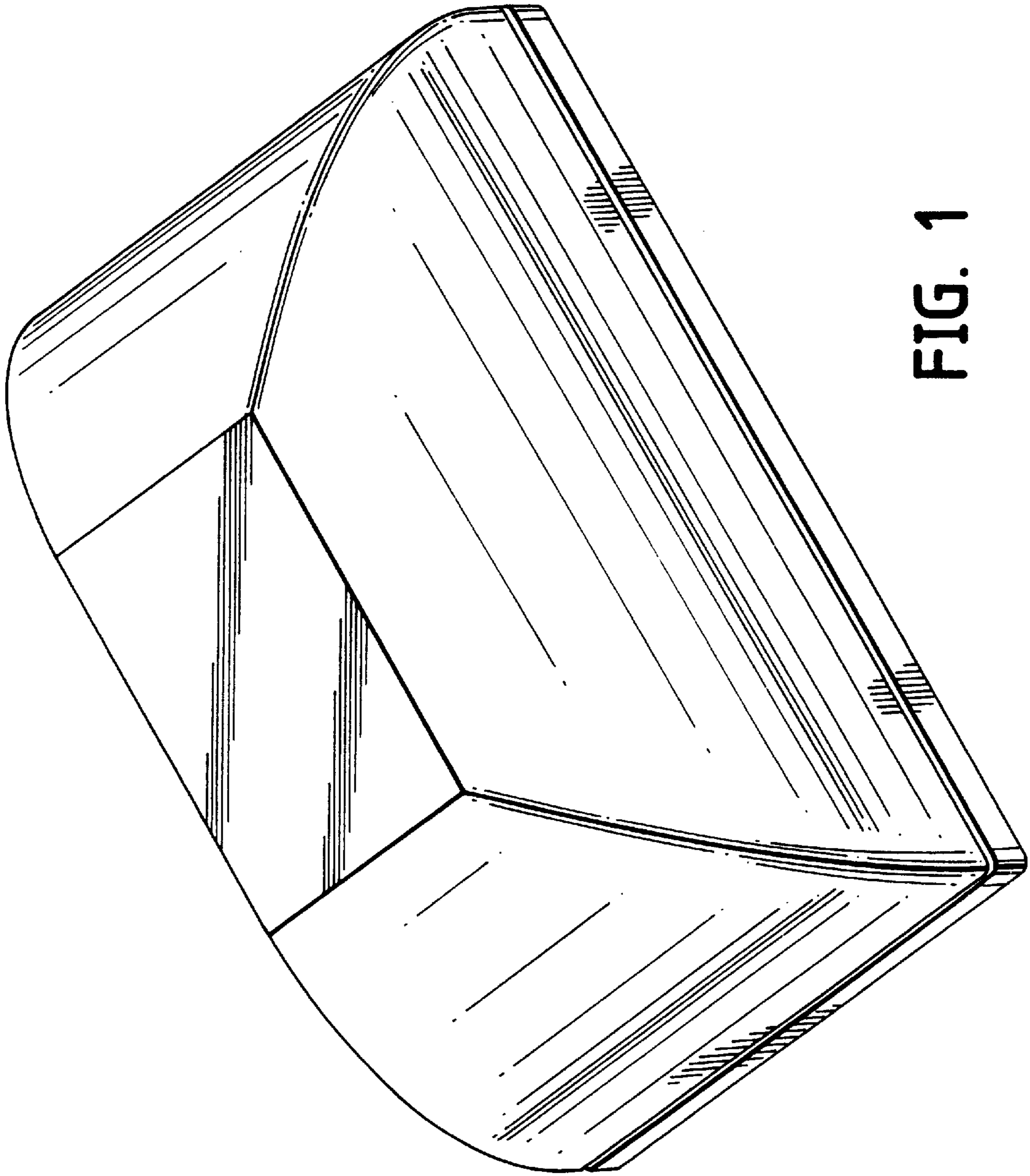

FIG. 1

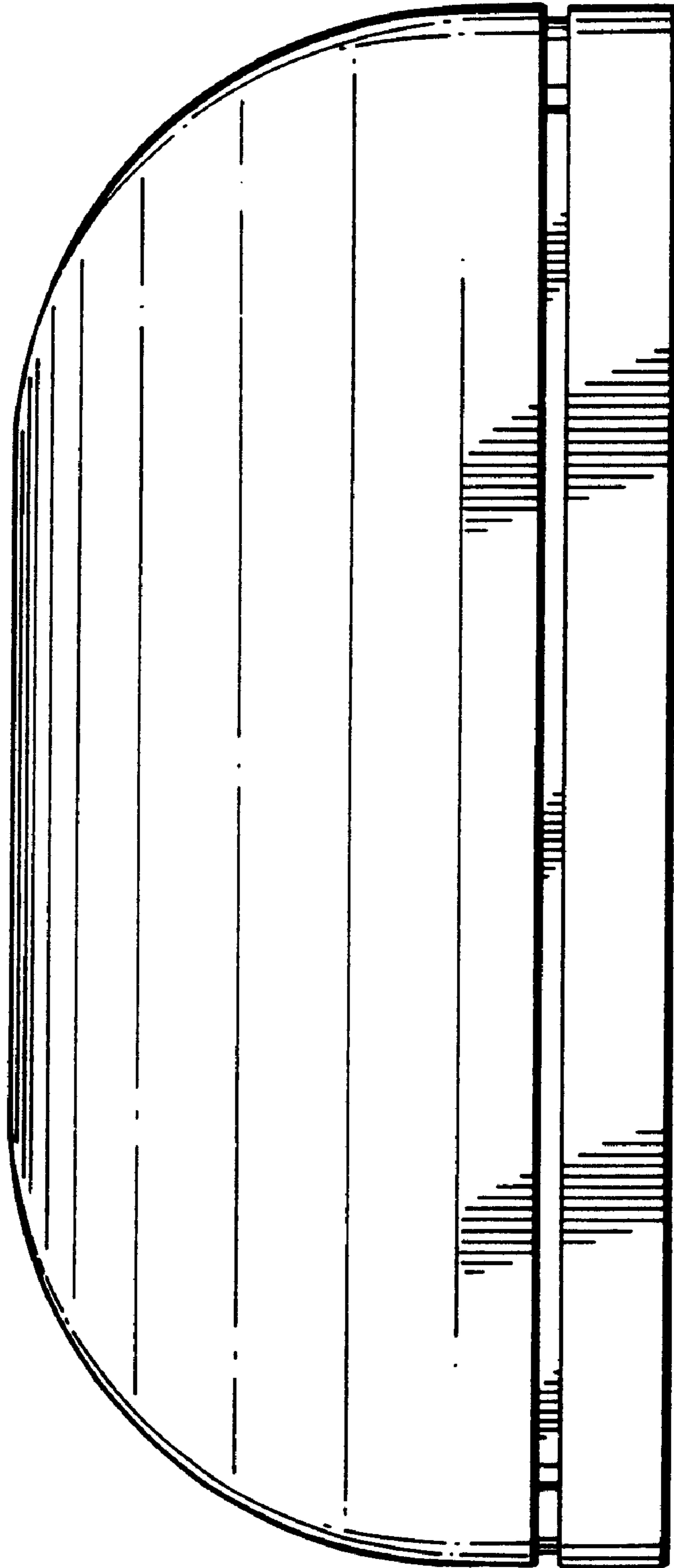

FIG. 2

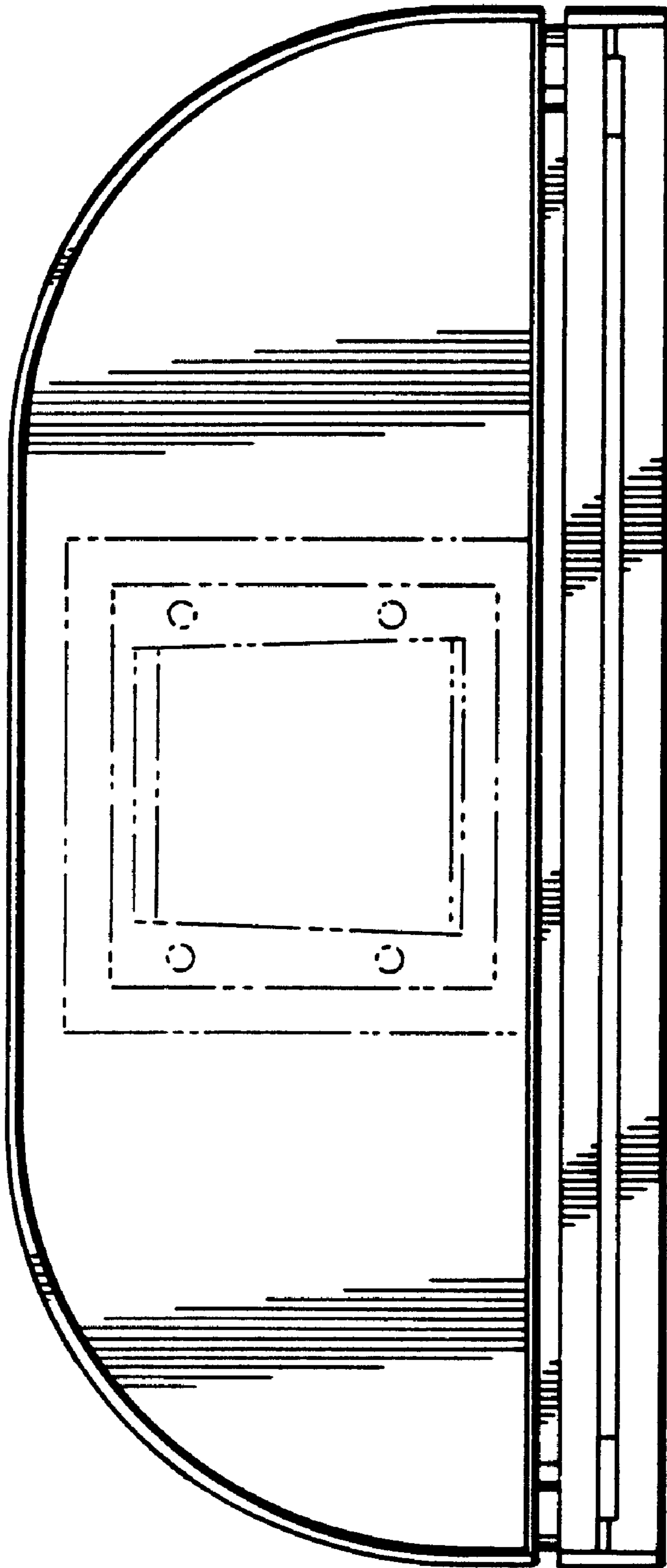

FIG. 3

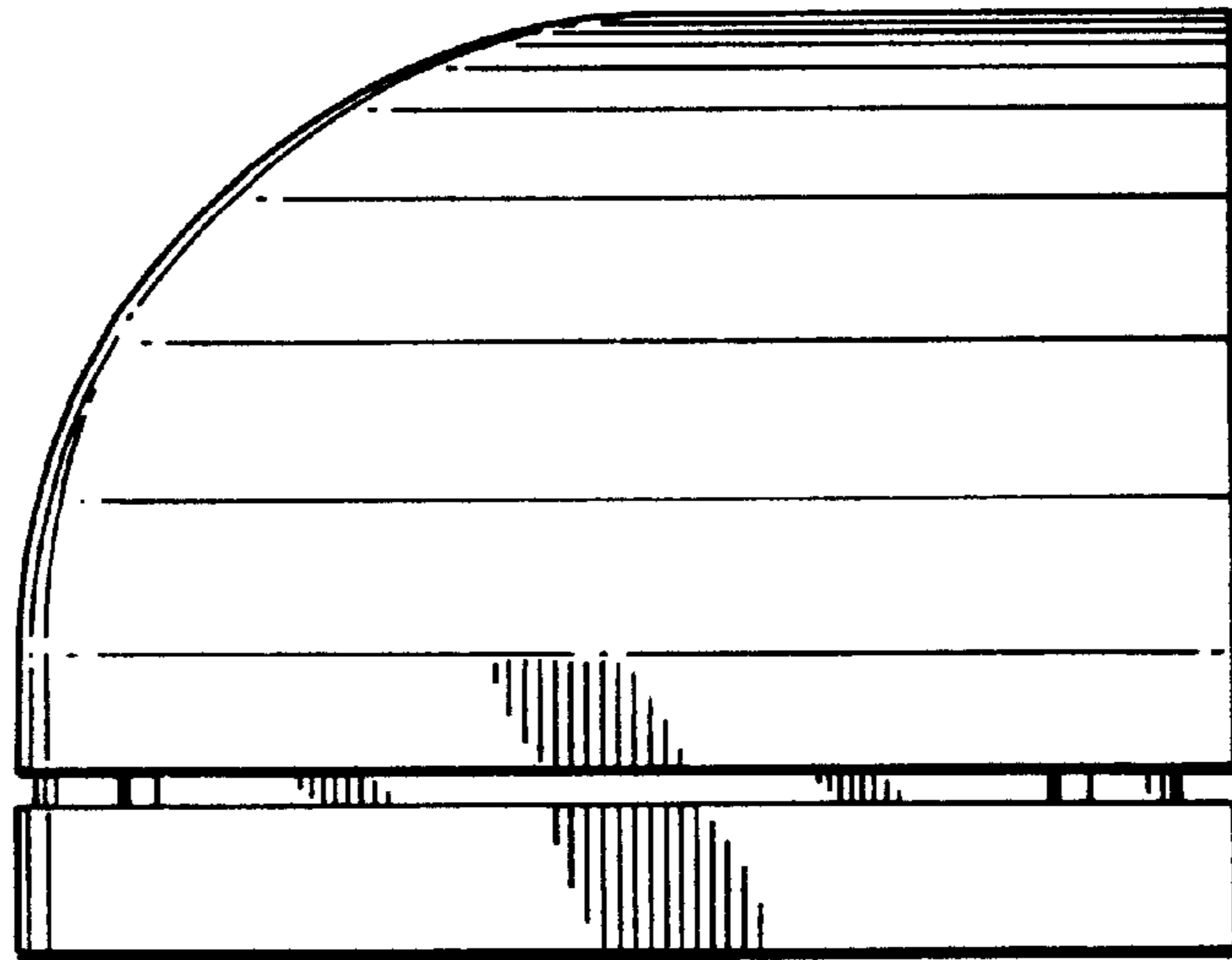

FIG. 4

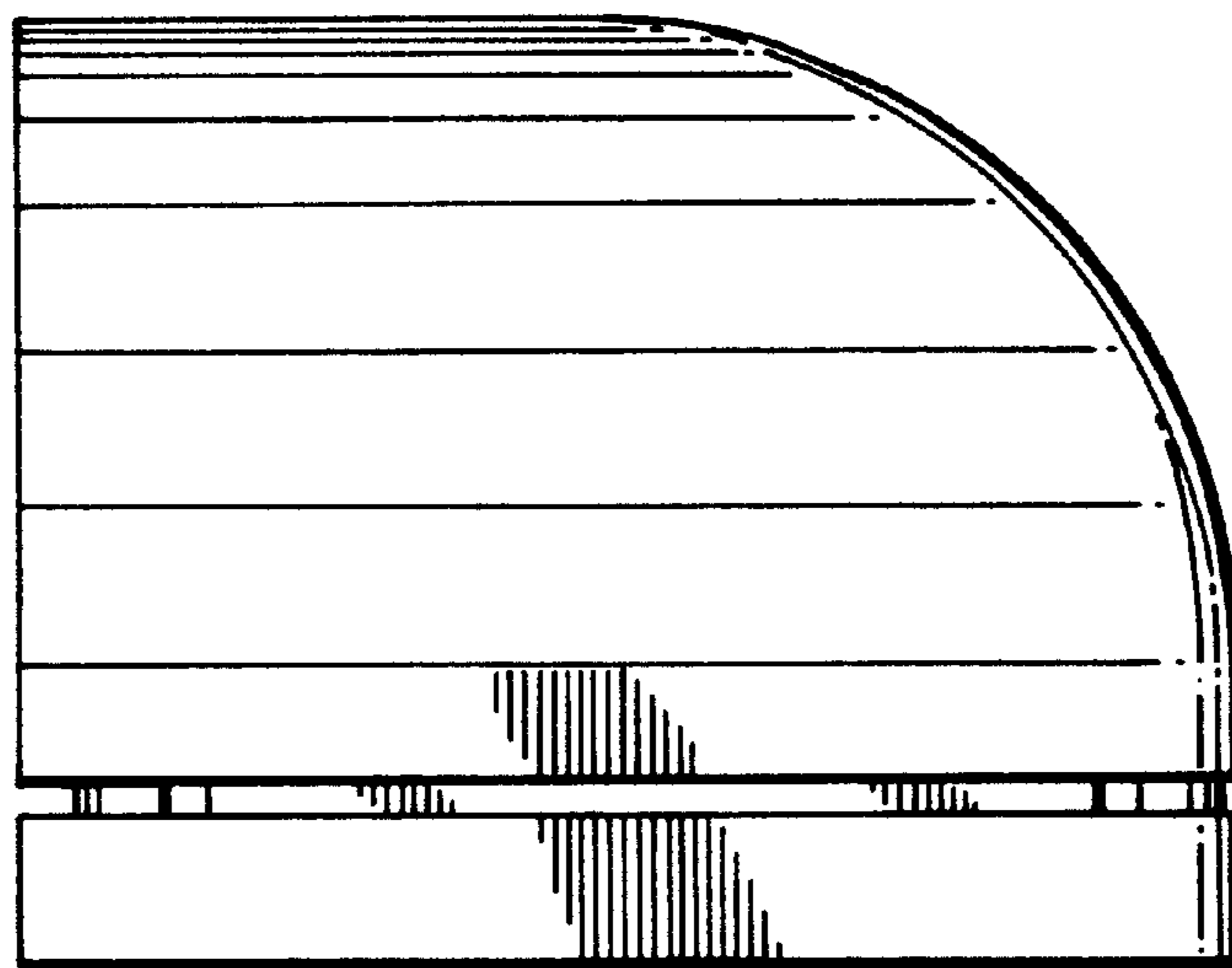

FIG. 5

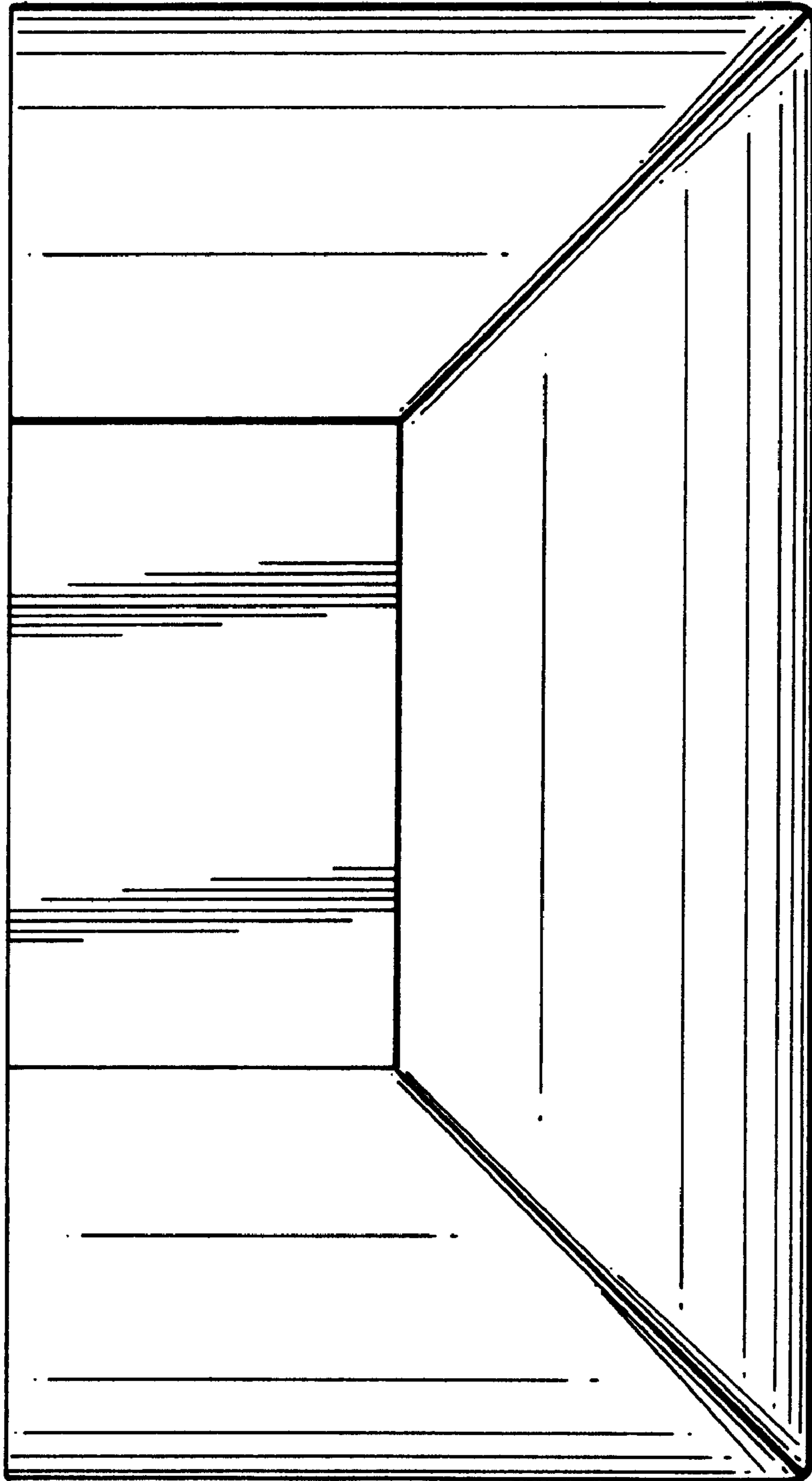

FIG. 6

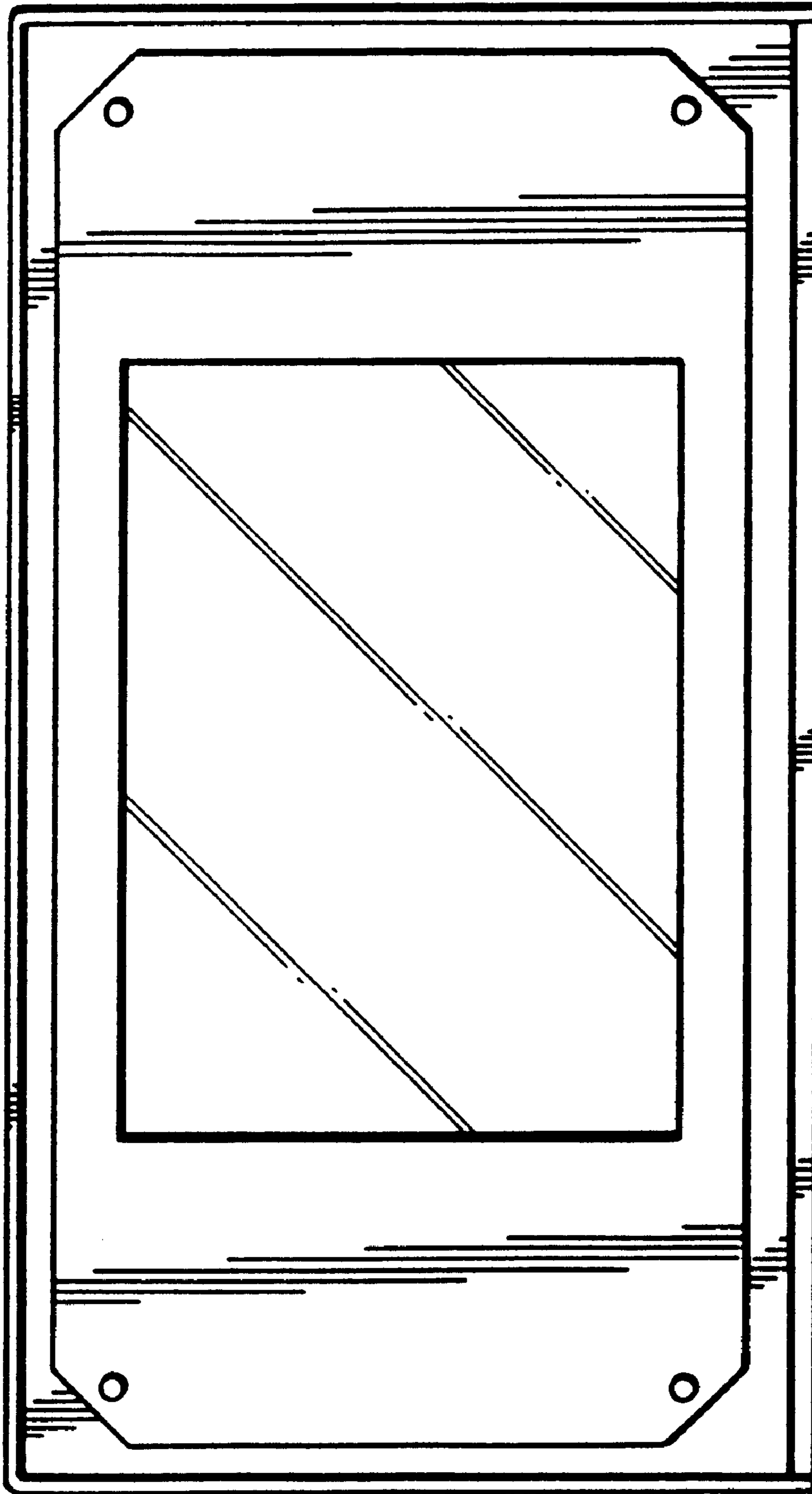

FIG. 7