



US00D456892S

(12) **United States Design Patent**
Hsieh

(10) **Patent No.:** **US D456,892 S**

(45) **Date of Patent:** **** May 7, 2002**

(54) **BLADE HOLDER FOR A CEILING FAN**

D421,115 S * 2/2000 Gee, II D23/411

* cited by examiner

(76) Inventor: **Frank Hsieh**, No. 103, Ta Feng Rd.,
Sheng Kang Hsiang, Taichung Hsien
(TW)

Primary Examiner—Lisa Lichtenstein
(74) *Attorney, Agent, or Firm*—Pro-Techtor International
Services

(**) Term: **14 Years**

(57) **CLAIM**

(21) Appl. No.: **29/149,447**

The ornamental design for blade holder for a ceiling fan, as
shown and described.

(22) Filed: **Oct. 9, 2001**

DESCRIPTION

(51) **LOC (7) Cl.** **23-04**

(52) **U.S. Cl.** **D23/411**

(58) **Field of Search** D23/411, 377,
D23/379, 385; 416/5, 210

FIG. 1 is a perspective view of a blade holder for a ceiling
fan showing my new design;
FIG. 2 is a front view thereof;
FIG. 3 is a rear view thereof;
FIG. 4 is a right view thereof;
FIG. 5 is a left view thereof;
FIG. 6 is a top view thereof; and,
FIG. 7 is a bottom view thereof.

(56) **References Cited**

U.S. PATENT DOCUMENTS

D303,425 S * 9/1989 Sonneman D23/377
D395,498 S * 6/1998 Gee, II D23/411

1 Claim, 4 Drawing Sheets

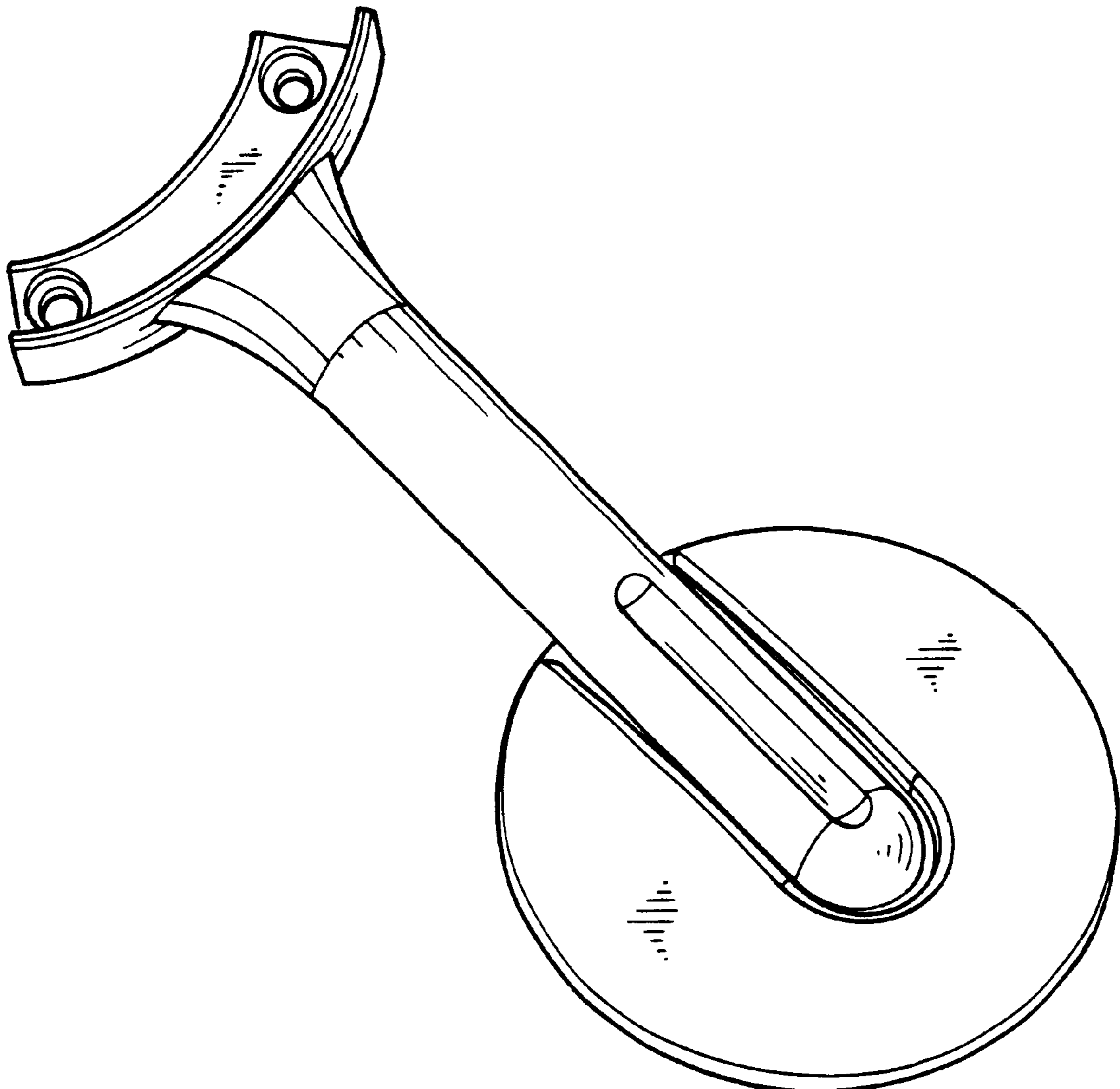

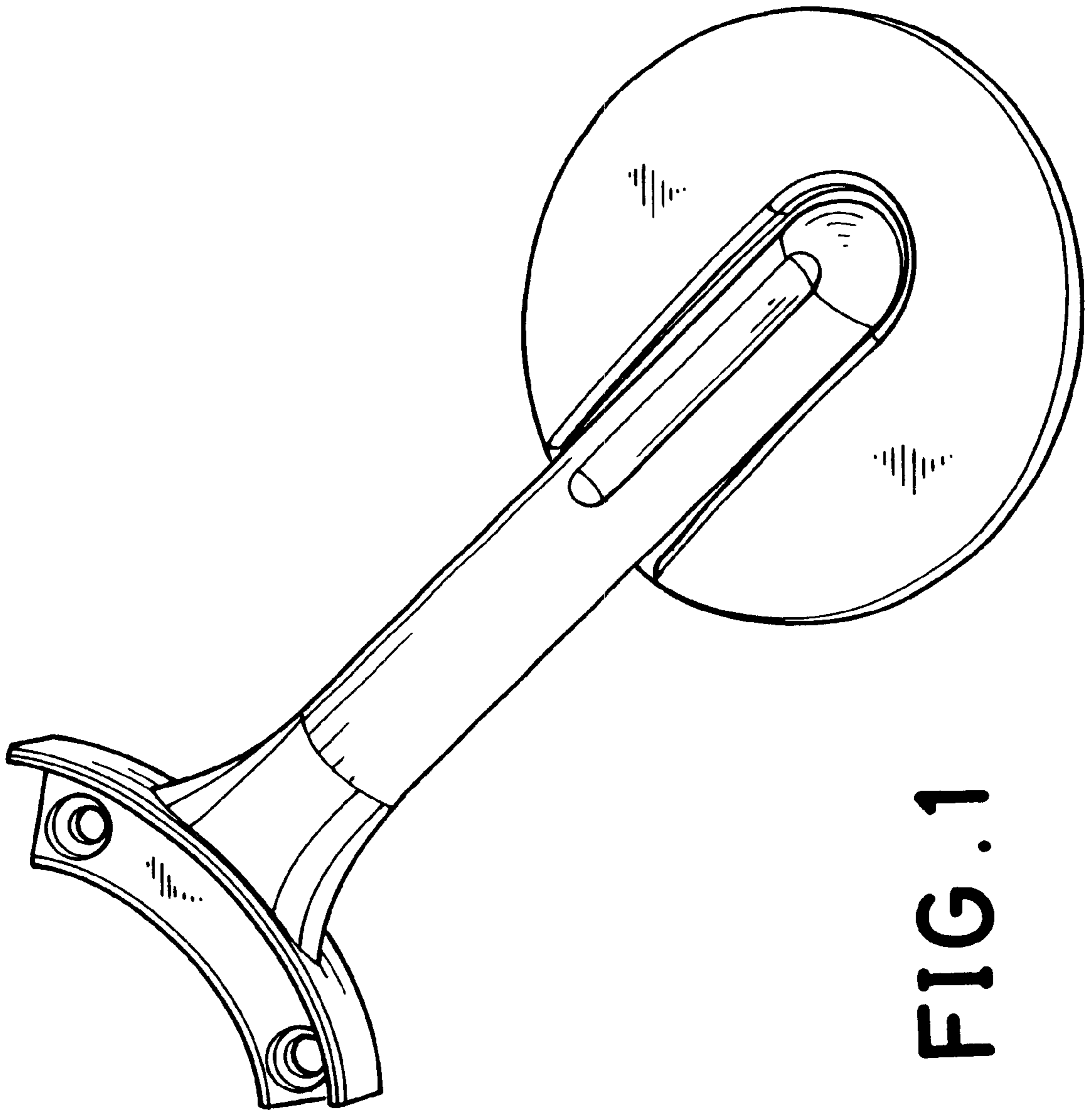

FIG. 1

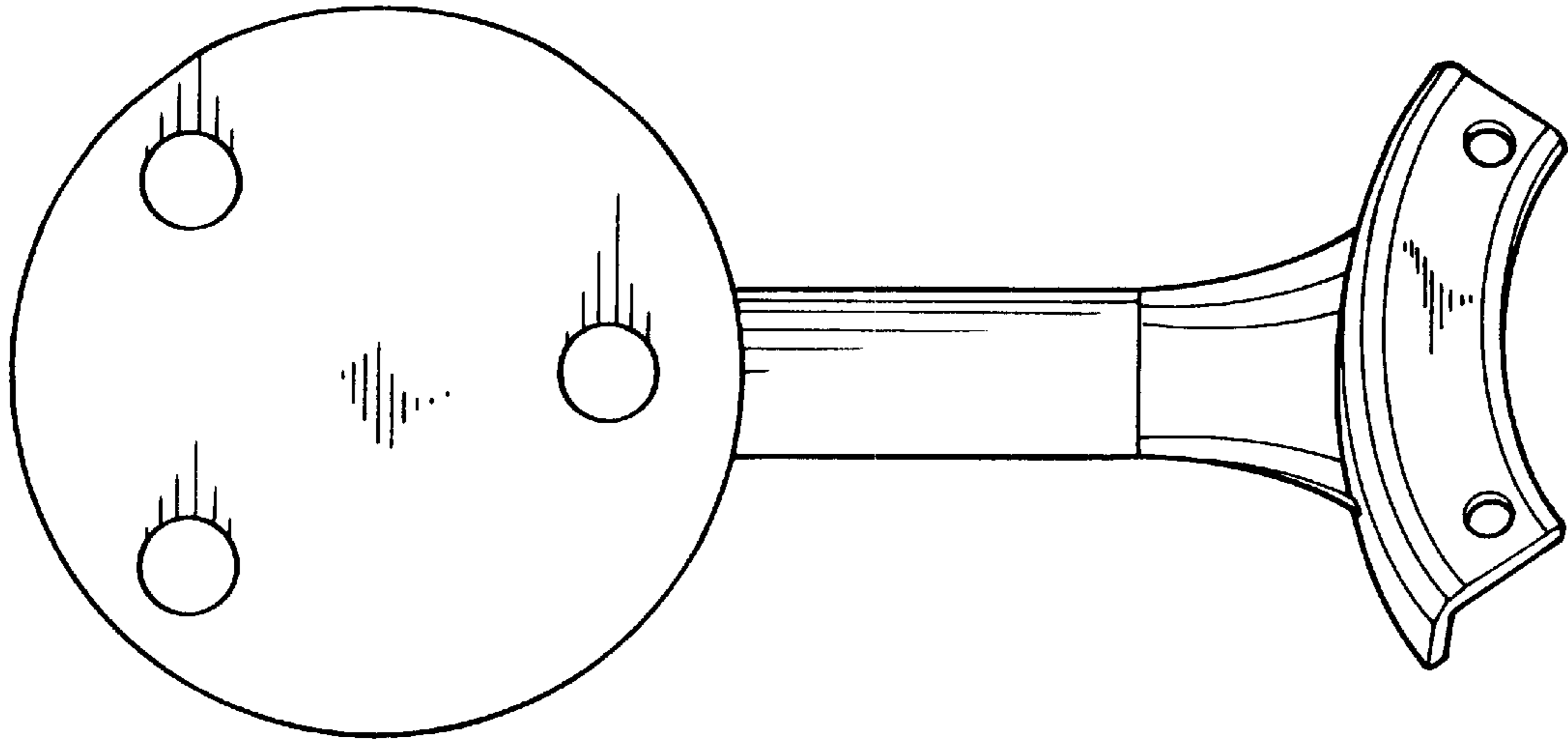

FIG. 3

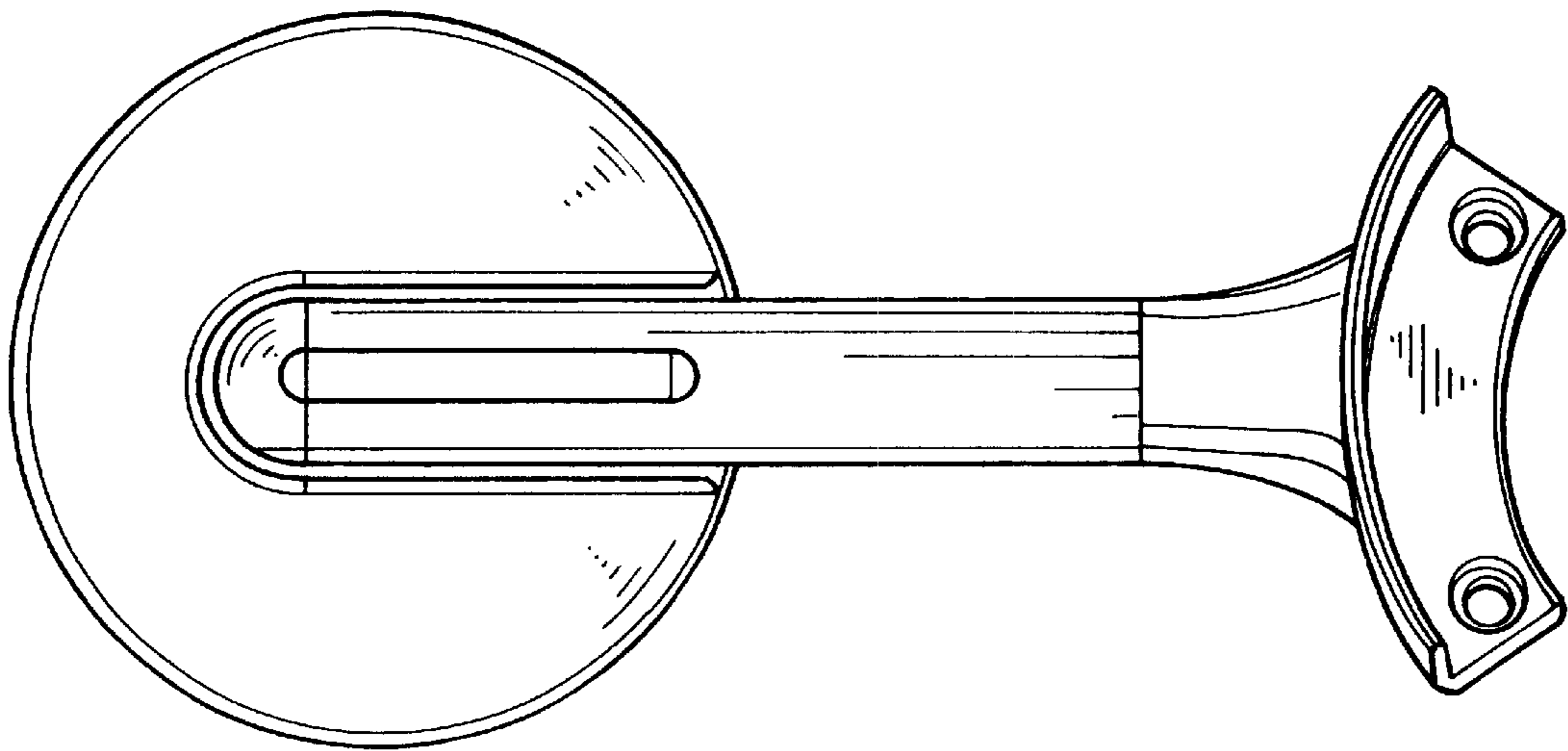

FIG. 2

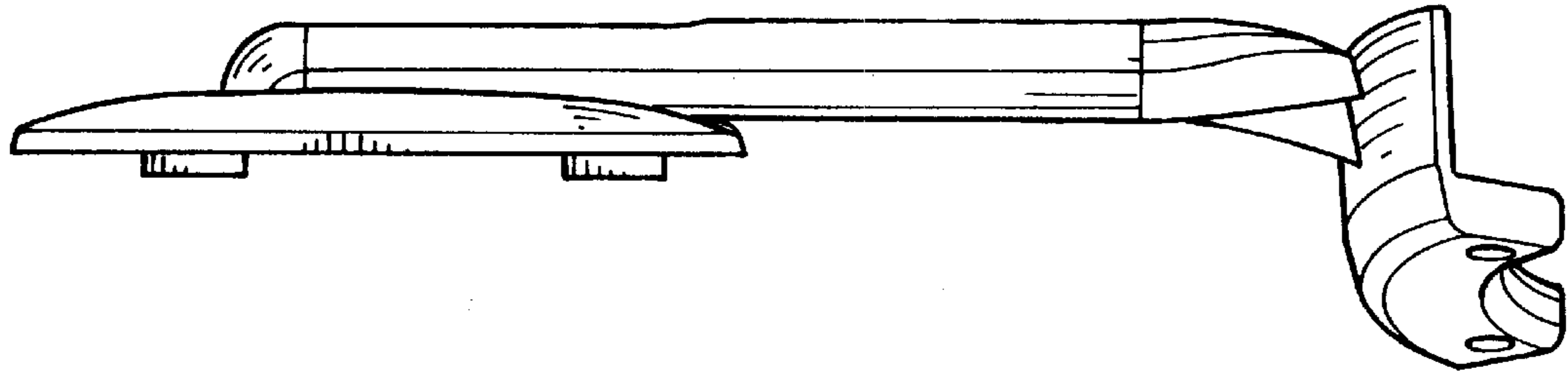

FIG. 5

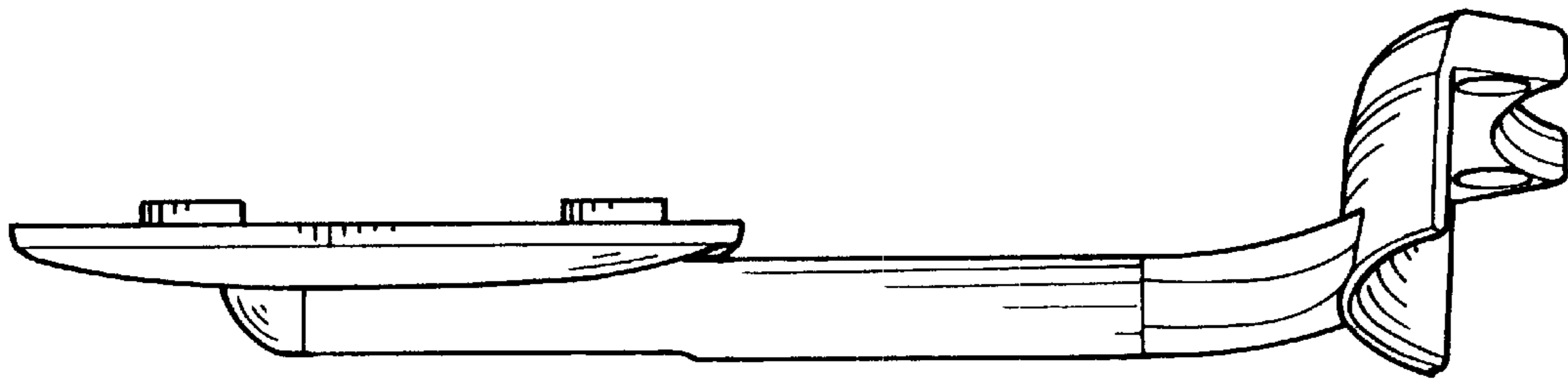

FIG. 4

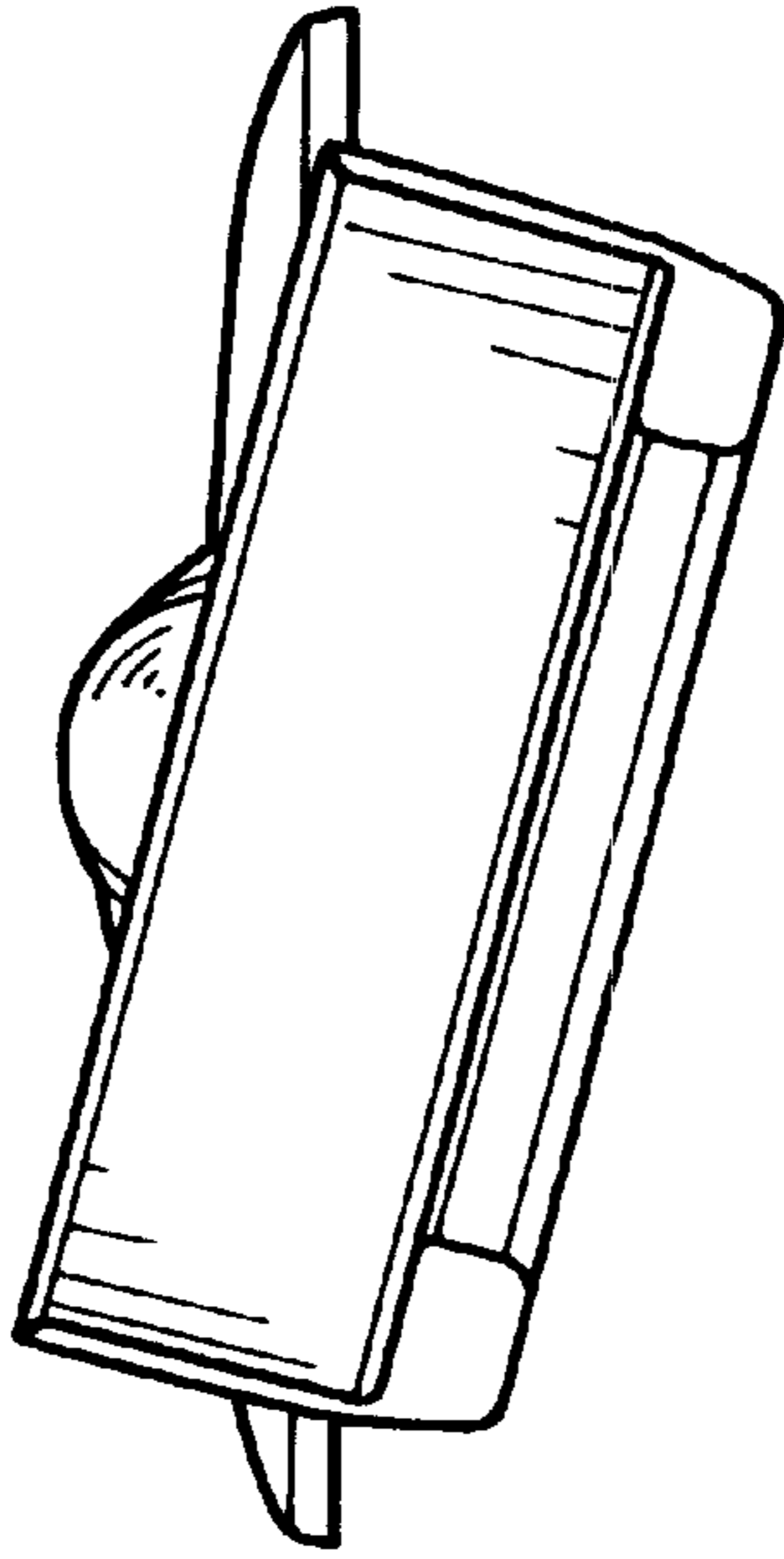

FIG. 7

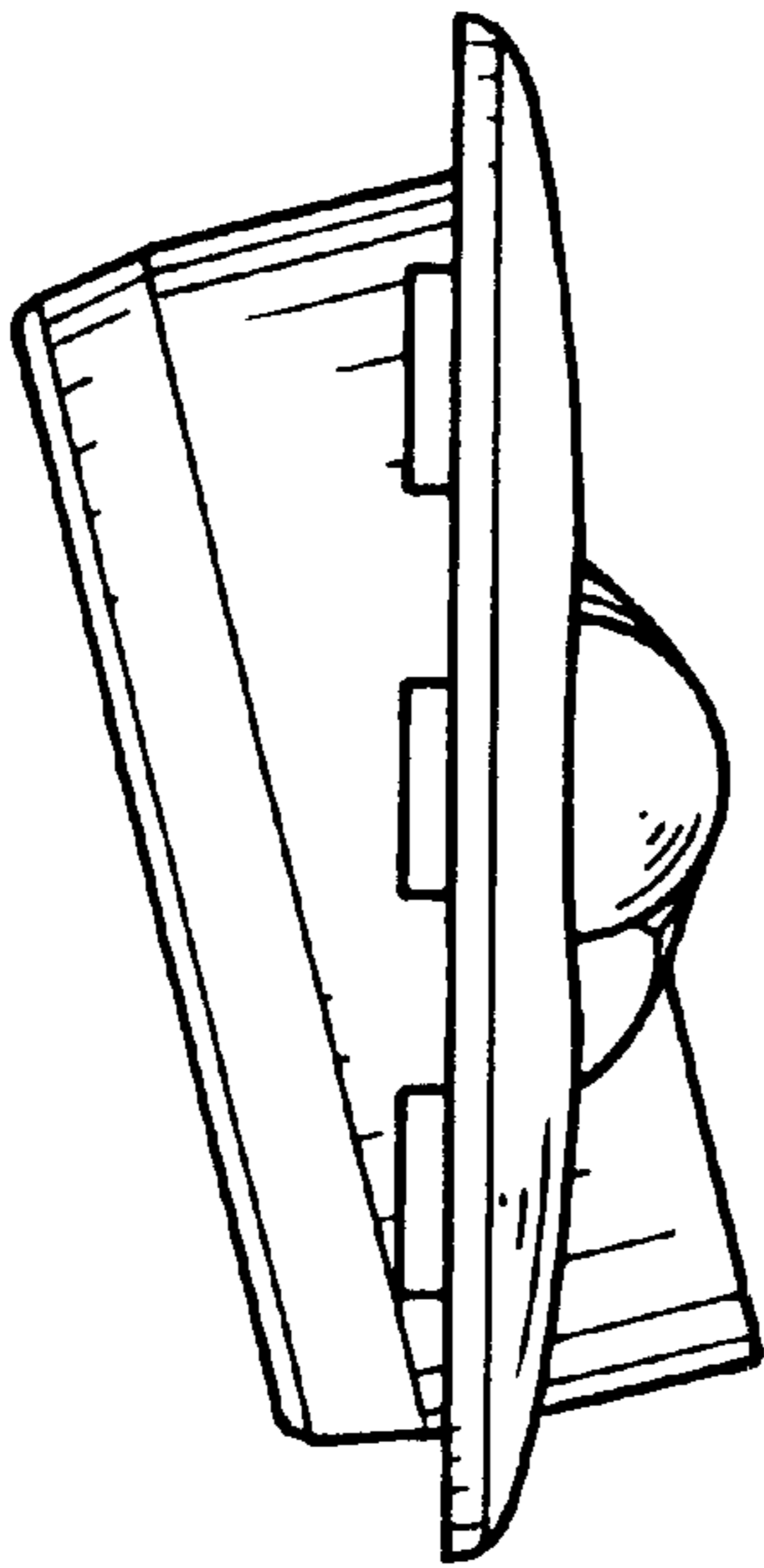

FIG. 6