



US00D456881S

(12) **United States Design Patent** (10) **Patent No.:** **US D456,881 S**
Thomas et al. (45) **Date of Patent:** **** May 7, 2002**

(54) **TUB FOR BATHING**

(75) Inventors: **Carter J. Thomas**, Cedarburg; **David J. O'Connell**; **Mary J. Reid**, both of Sheboygan, all of WI (US)

(73) Assignee: **Kohler Co.**, Kohler, WI (US)

(**) Term: **14 Years**

(21) Appl. No.: **29/145,888**

(22) Filed: **Jul. 31, 2001**

Related U.S. Application Data

(62) Division of application No. 29/127,420, filed on Aug. 4, 2000, now Pat. No. Des. 446,574.

(51) **LOC (7) Cl.** **23-02**

(52) **U.S. Cl.** **D23/277**

(58) **Field of Search** D23/275-278, D23/280.2, 303-307; 4/538, 540, 541.1-541.6, 546, 548, 557, 558, 584, 594

(56) **References Cited**

U.S. PATENT DOCUMENTS

D90,640 S	9/1933	Yent	D23/277
3,020,561 A	2/1962	Cotting	4/595
3,151,341 A	10/1964	King	D23/283 X
D221,139 S	7/1971	Diemond et al.	D23/280.1 X
D241,643 S	9/1976	Bronsack	D23/280.1
D275,783 S	10/1984	McMillan et al.	D23/283
5,459,888 A	10/1995	Chen	4/593

OTHER PUBLICATIONS

1999 Kallista catalog ad, p. 70, showing a "Barbara Barry" whirlpool bath.

1999 catalog ad, supplier unknown, showing a whirlpool bath.

Undated Villeroy & Boch catalog ad showing a "Magnum" whirlpool bath.

Undated Altmans catalog ad showing a "Francine" bath. 1989 Kohler catalog ad, p. 5A-5, showing "Vintage Suite" baths.

Primary Examiner—Louis S. Zarfes

Assistant Examiner—Robert A. Delehanty

(74) *Attorney, Agent, or Firm*—Quarles & Brady LLP

(57) **CLAIM**

The ornamental design for a tub for bathing, as shown and described.

DESCRIPTION

In a preferred embodiment, the nature of this product is as a plumbing fixture primarily useful for washing the body of humans.

FIG. 1 is a right, top, front perspective view of a tub for bathing embodying our new design;

FIG. 2 is a top plan view thereof;

FIG. 3 is a front elevational view thereof;

FIG. 4 is a right side elevational view thereof, the left side elevational view being identical to the right side shown;

FIG. 5 is a rear elevational view thereof;

FIG. 6 is a bottom plan view thereof;

FIG. 7 is a right, top, front perspective view of a second embodiment in which an alternative wall structure has replaced the wall structure shown in the first embodiment, the bottom plan view being identical to that shown in FIG. 6;

FIG. 8 is a top plan view thereof;

FIG. 9 is a front elevational view thereof, the rear elevational view being identical to the front elevational view shown; and,

FIG. 10 is a right side elevational view thereof, the left side elevational view being identical to the right side shown.

The broken line representations of holes in FIGS. 1, 2, 6, 7 and 8 are for the purpose of illustration only, and form no part of the claimed design.

1 Claim, 7 Drawing Sheets

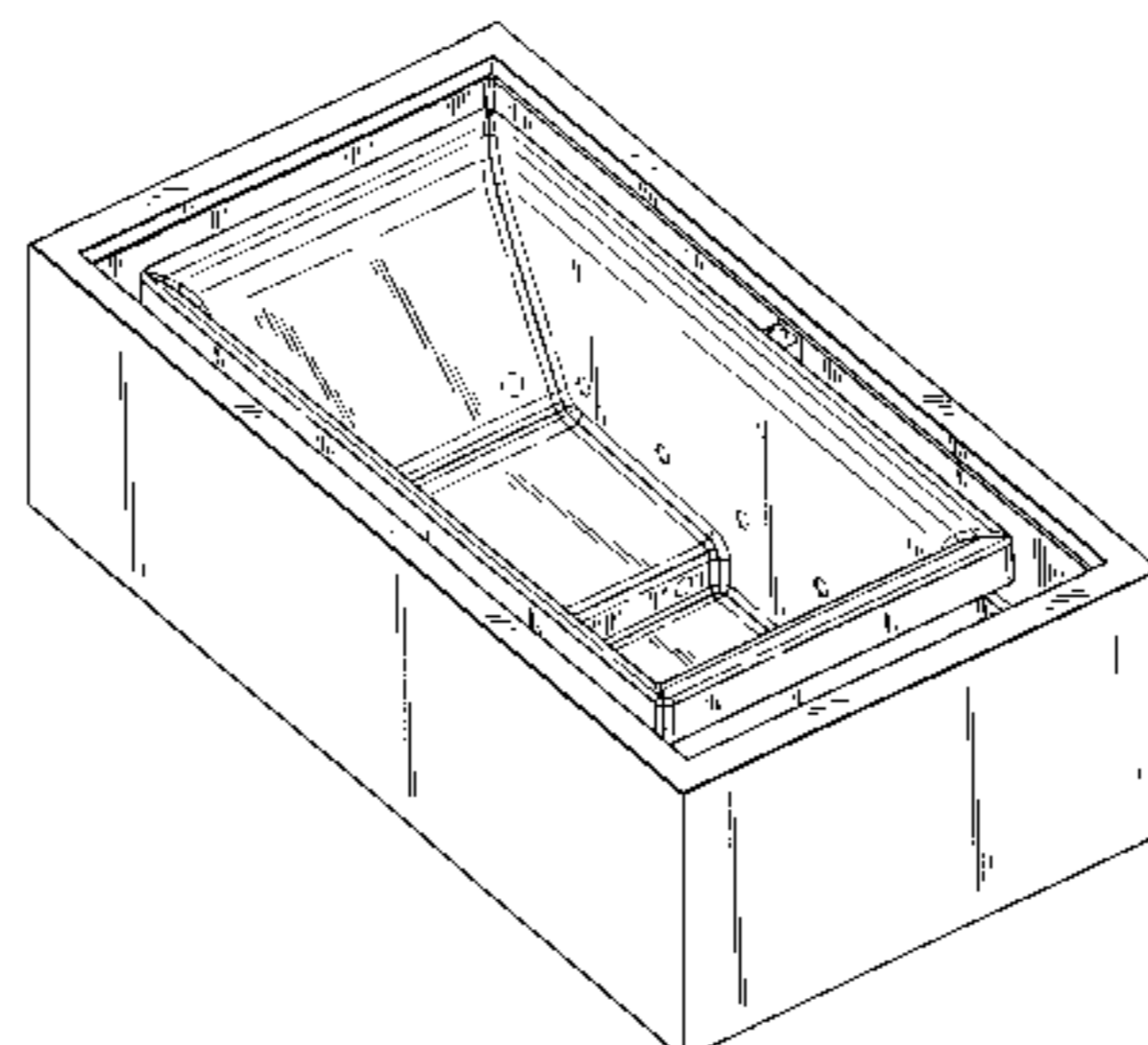
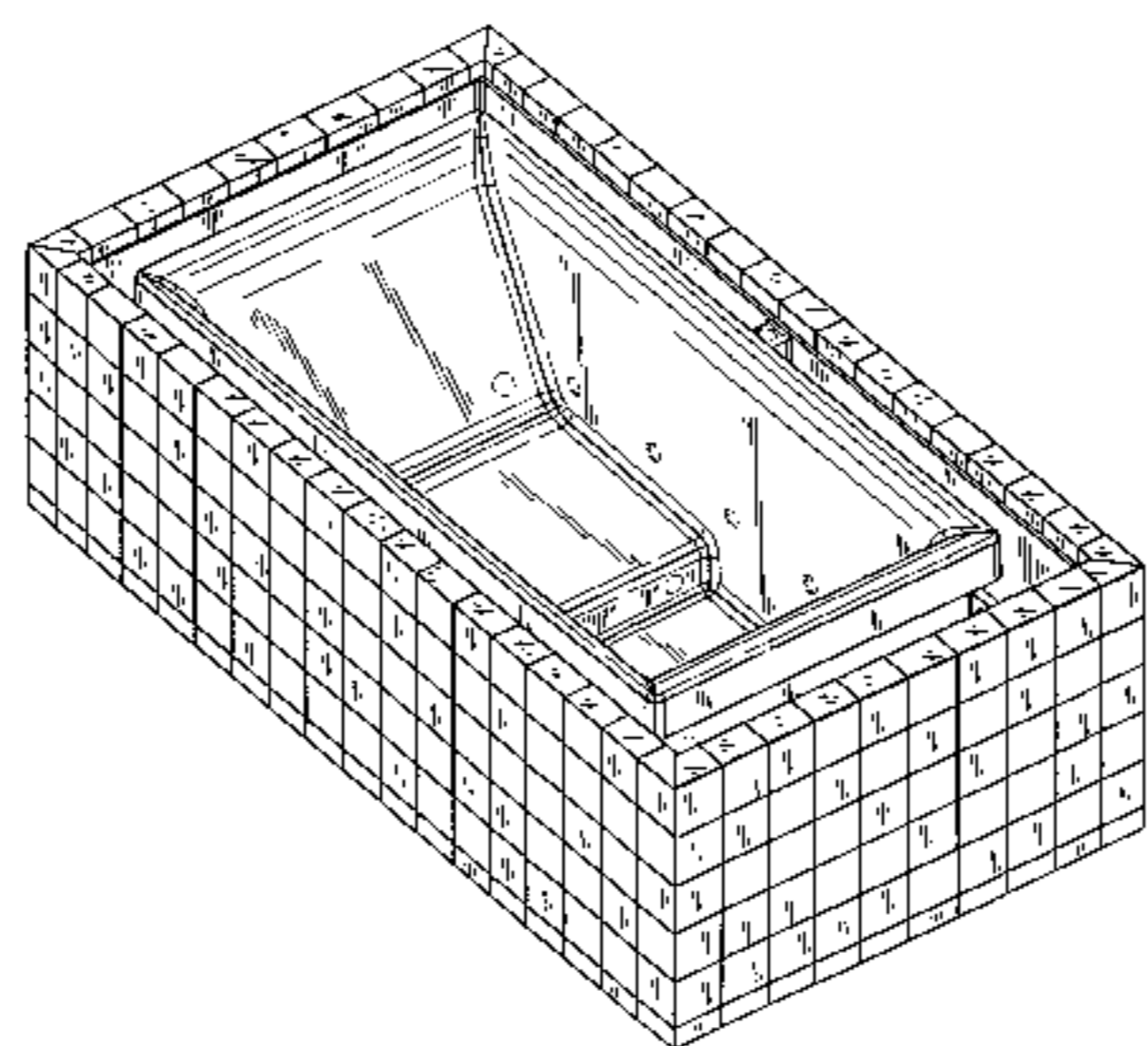

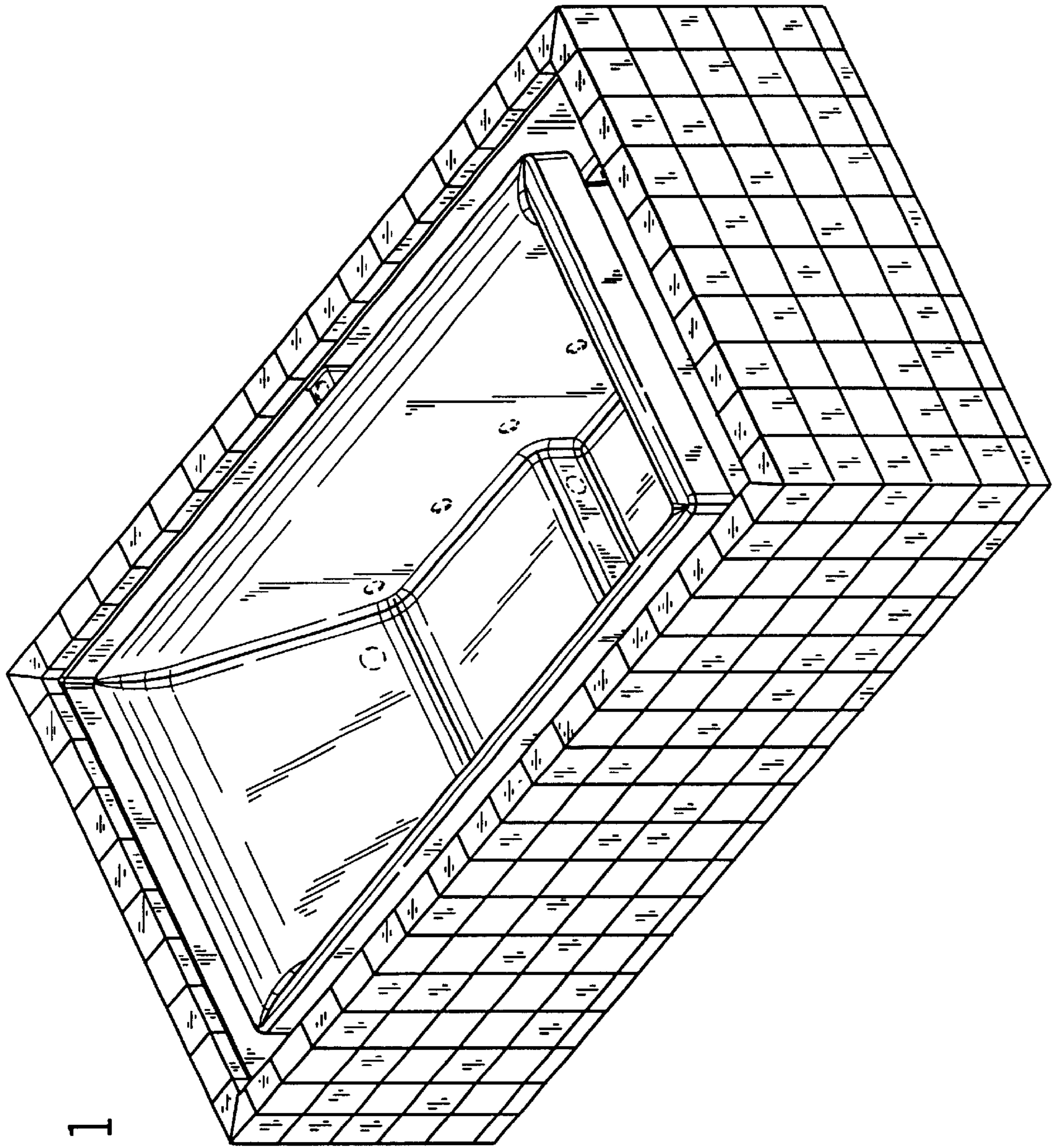

FIG. 1

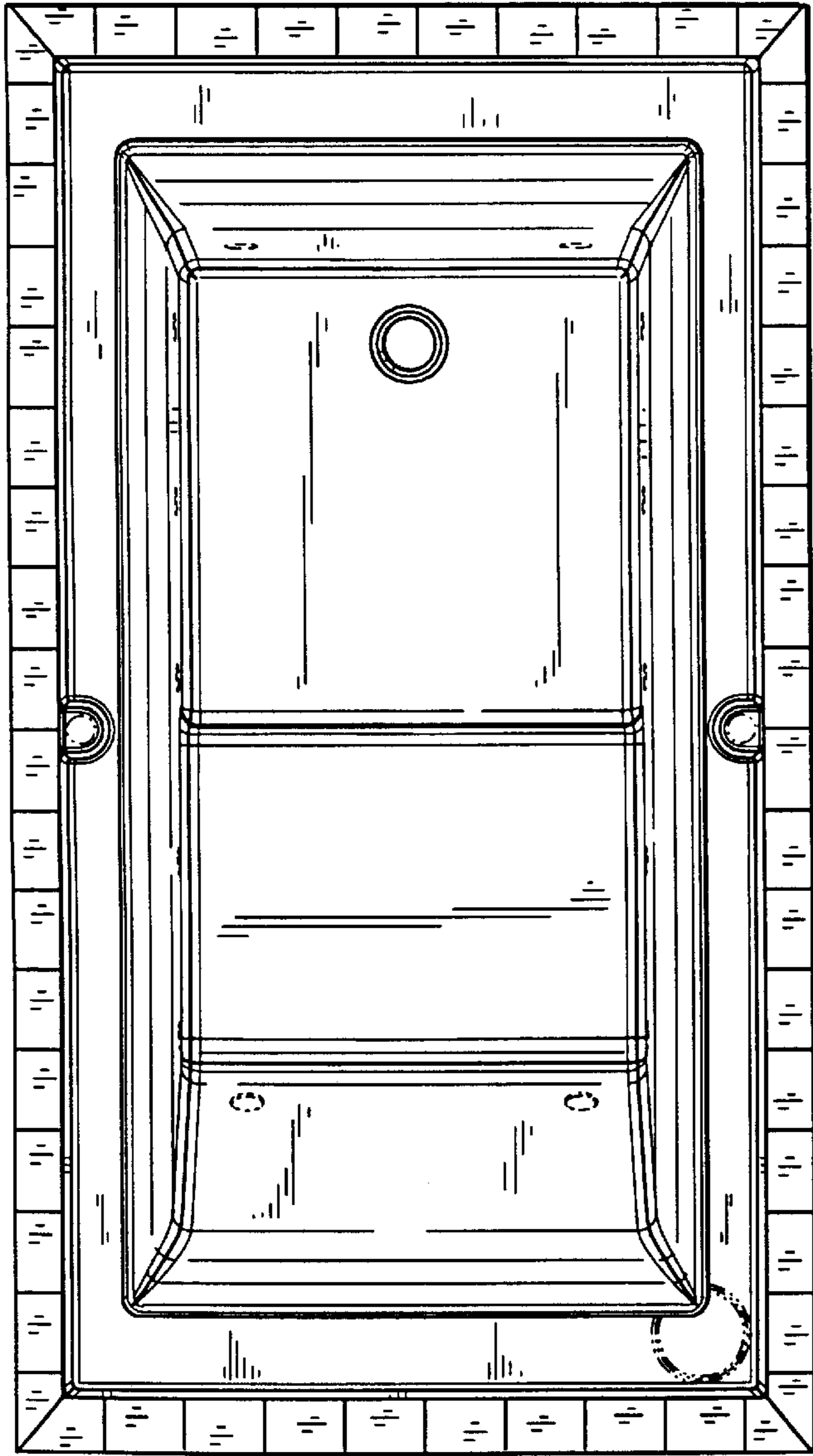

FIG. 2

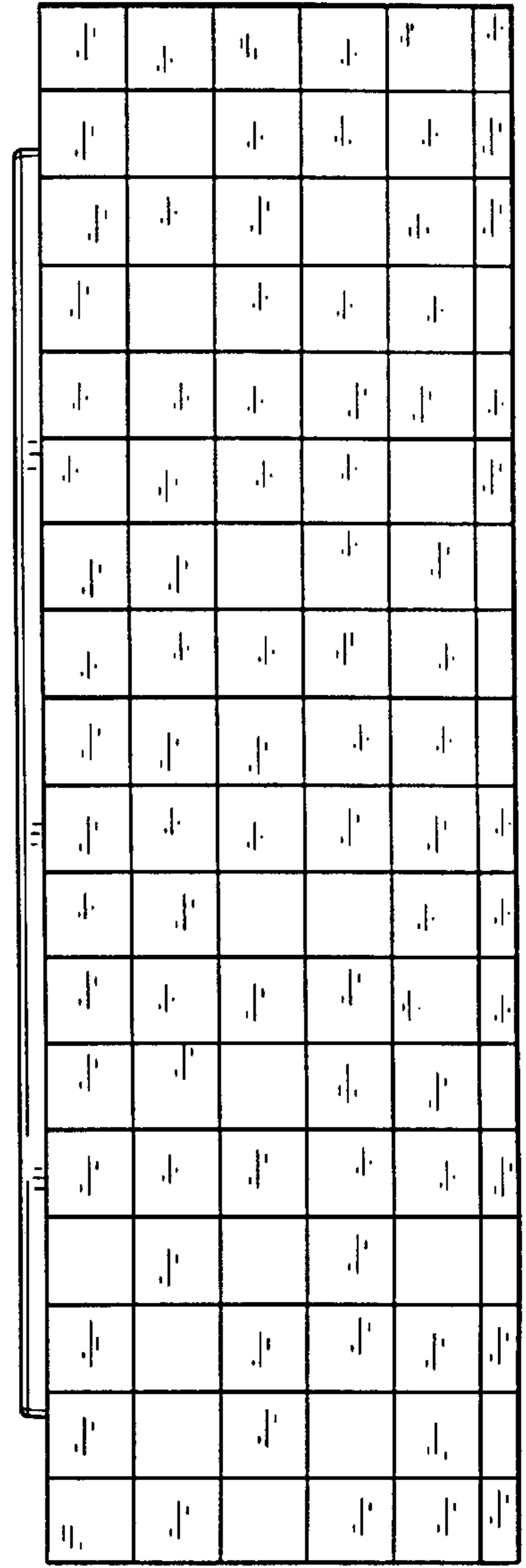

FIG. 3

FIG. 4

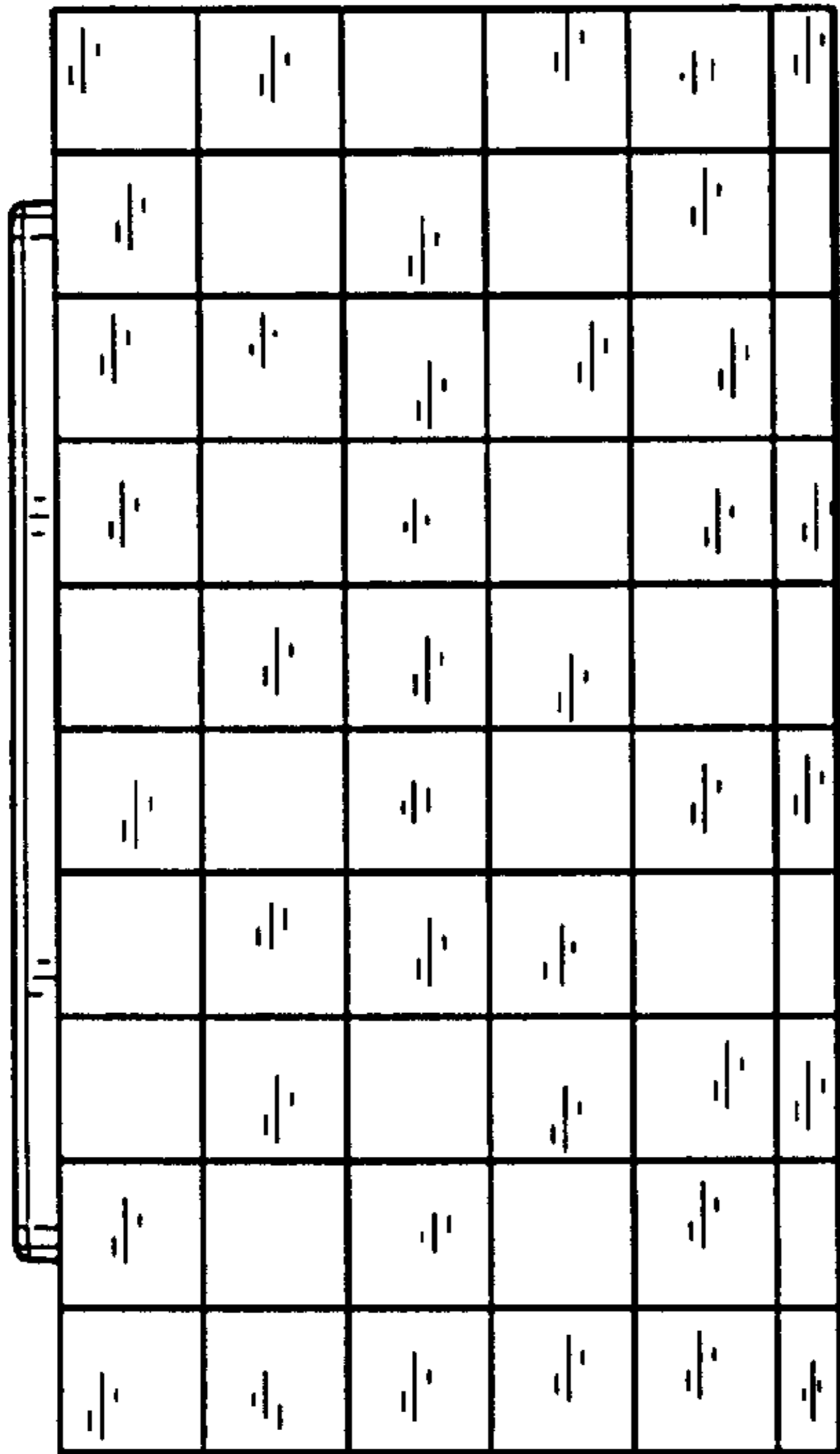

FIG. 5

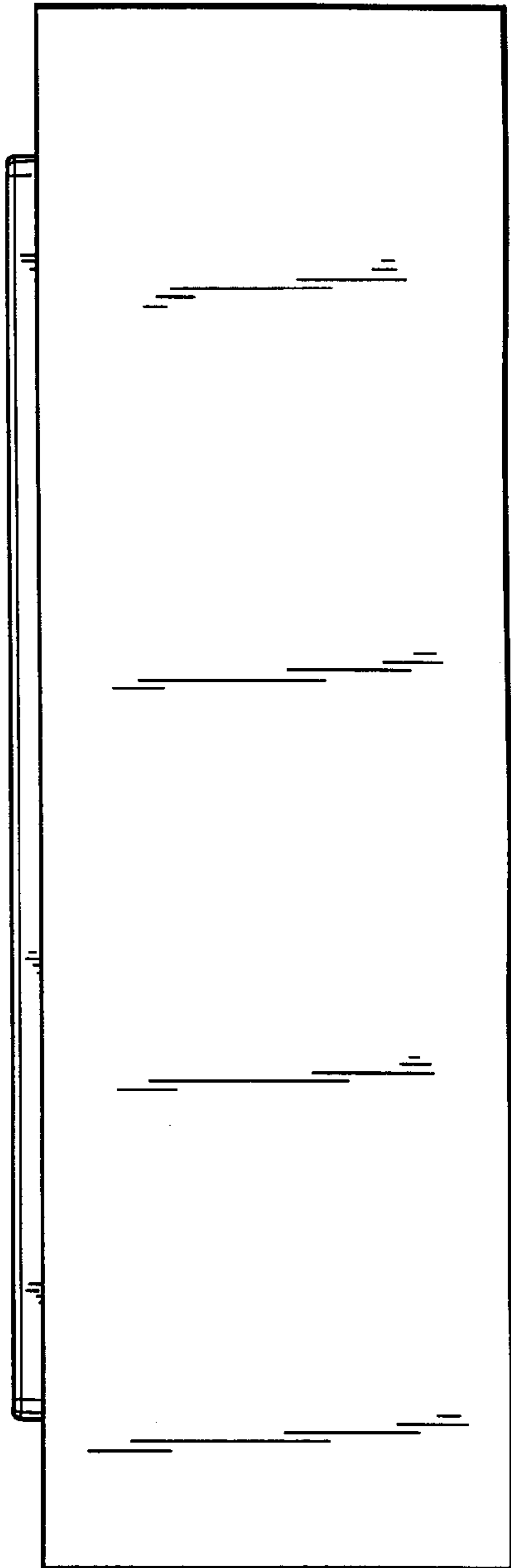
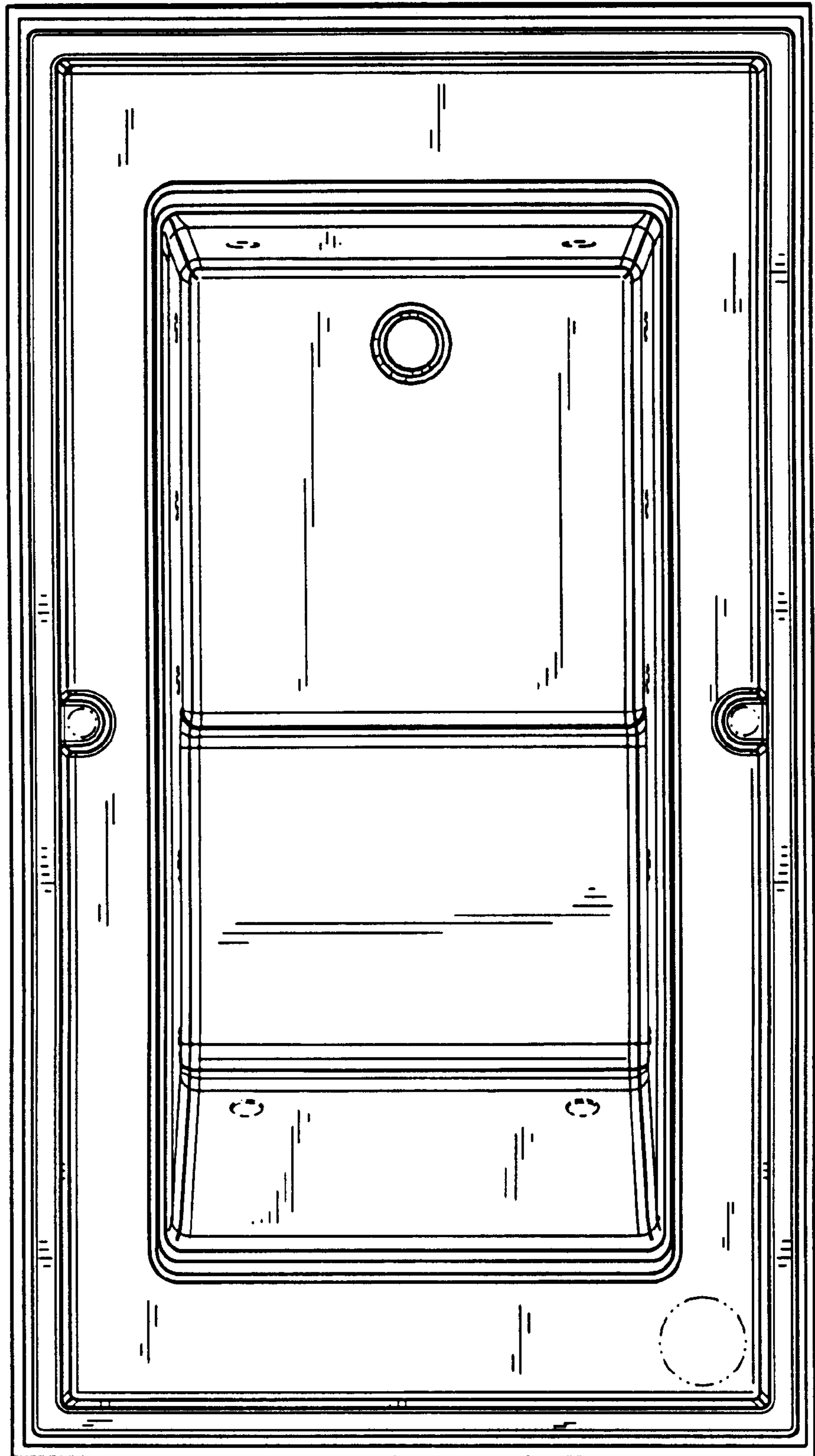

FIG. 6



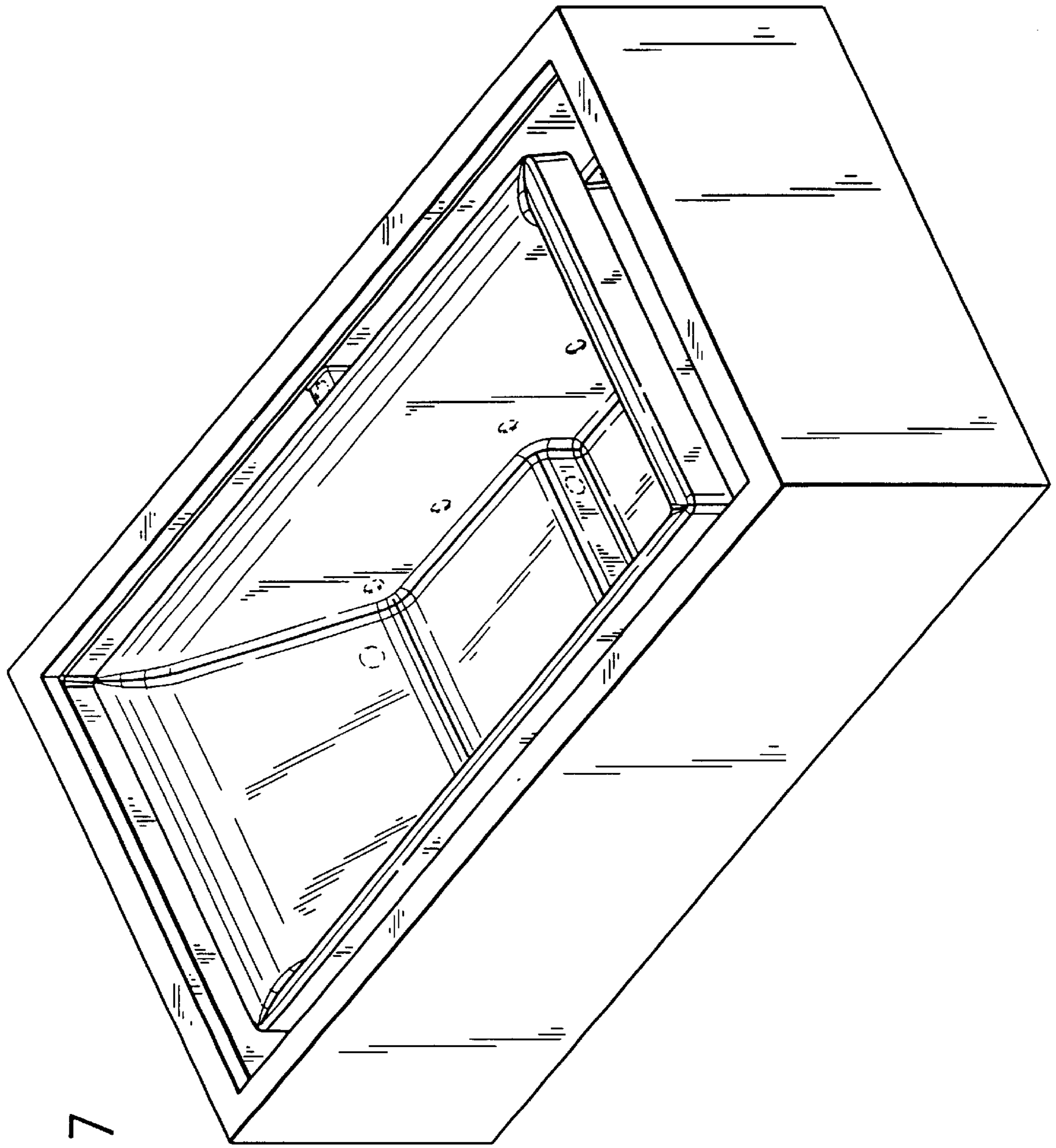

FIG. 7

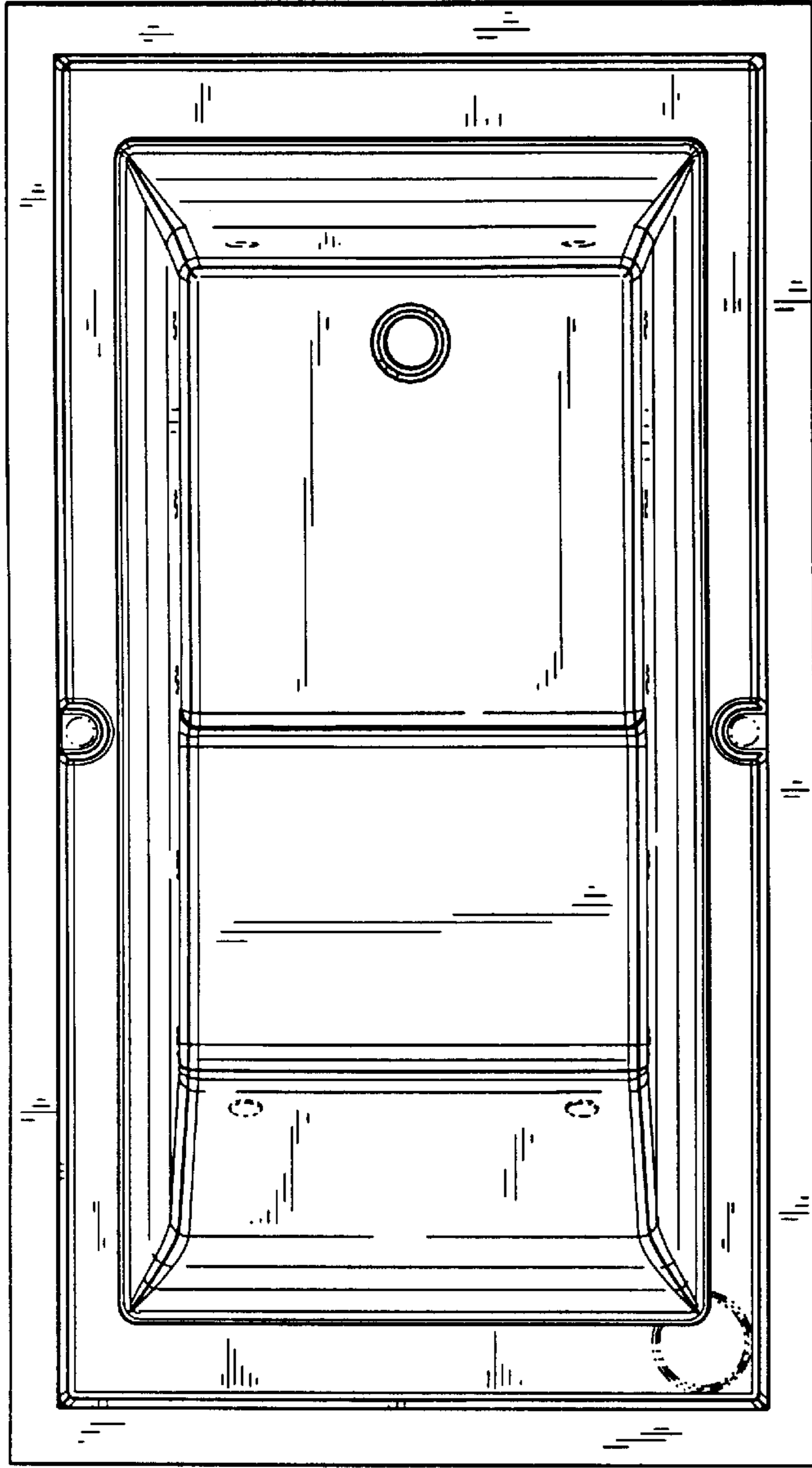

FIG. 8

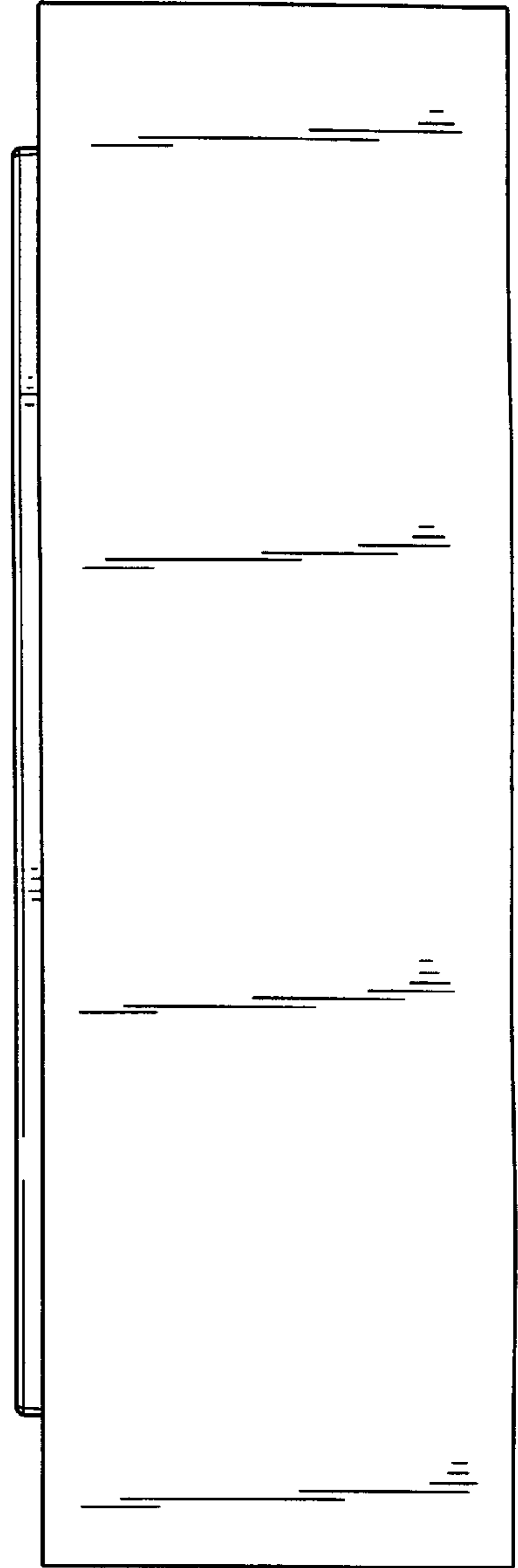

FIG. 9

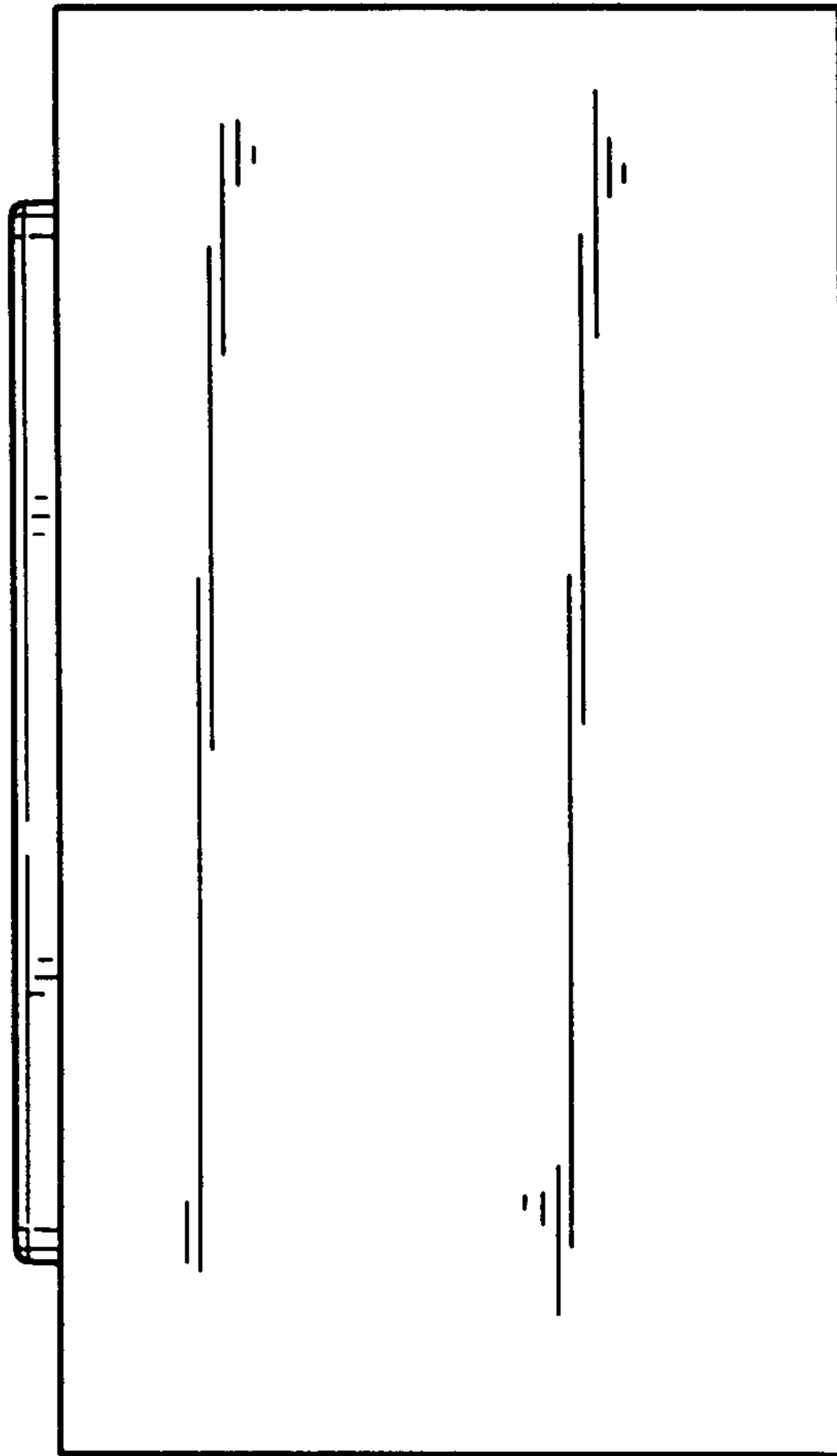

FIG. 10