



US00D456866S

(12) **United States Design Patent**
Turpault et al.

(10) **Patent No.:** **US D456,866 S**

(45) **Date of Patent:** **** May 7, 2002**

(54) **BALL THROWING MACHINE**

D422,028 S * 3/2000 Warner D21/270

(75) Inventors: **Matthieu Dominic Turpault**, Wayne, PA (US); **Peter D. Byar**, Willingboro, NJ (US); **Leslie Juhng**, Philadelphia, PA (US)

OTHER PUBLICATIONS

Webpages showing Prince Tennis Ball Machines (www.princetennis.com).

* cited by examiner

(73) Assignee: **Lob-ster, Inc.**, Plainfield, NJ (US)

Primary Examiner—Dominic Simone

(**) Term: **14 Years**

(74) *Attorney, Agent, or Firm*—Lerner, David, Littenberg, Krumholz & Mentlik, LLP

(21) Appl. No.: **29/140,756**

(57) **CLAIM**

(22) Filed: **Apr. 23, 2001**

The ornamental design for a ball throwing machine, as shown and described.

(51) **LOC (7) Cl.** **21-02**

DESCRIPTION

(52) **U.S. Cl.** **D21/698; D21/780; D21/789; D21/799; D21/720**

(58) **Field of Search** D21/698, 720, D21/780, 799, 789; 124/1, 4, 6, 16, 78, 79

FIG. 1 is a side perspective view of a ball throwing machine in accordance with the present invention; FIG. 2 is a front view thereof; FIG. 3 is a rear view thereof; FIG. 4 is a left side view thereof, the opposite side being a mirror image; FIG. 5 is a top plan view thereof; and, FIG. 6 is a front perspective view of an alternate arrangement of the ball throwing machine of FIG. 1, the only difference being the inversion of the removable top portion and its placement over the bottom portion.

(56) **References Cited**

U.S. PATENT DOCUMENTS

- 1,531,105 A * 3/1925 Knowlton 124/4
- 2,908,266 A * 10/1959 Cooper 124/6
- 2,918,915 A * 12/1959 Doeg 124/78
- D235,153 S * 5/1975 Conde D21/720
- 3,913,552 A * 10/1975 Yarur et al. 124/78
- D356,842 S * 3/1995 Trapp D21/270

1 Claim, 6 Drawing Sheets

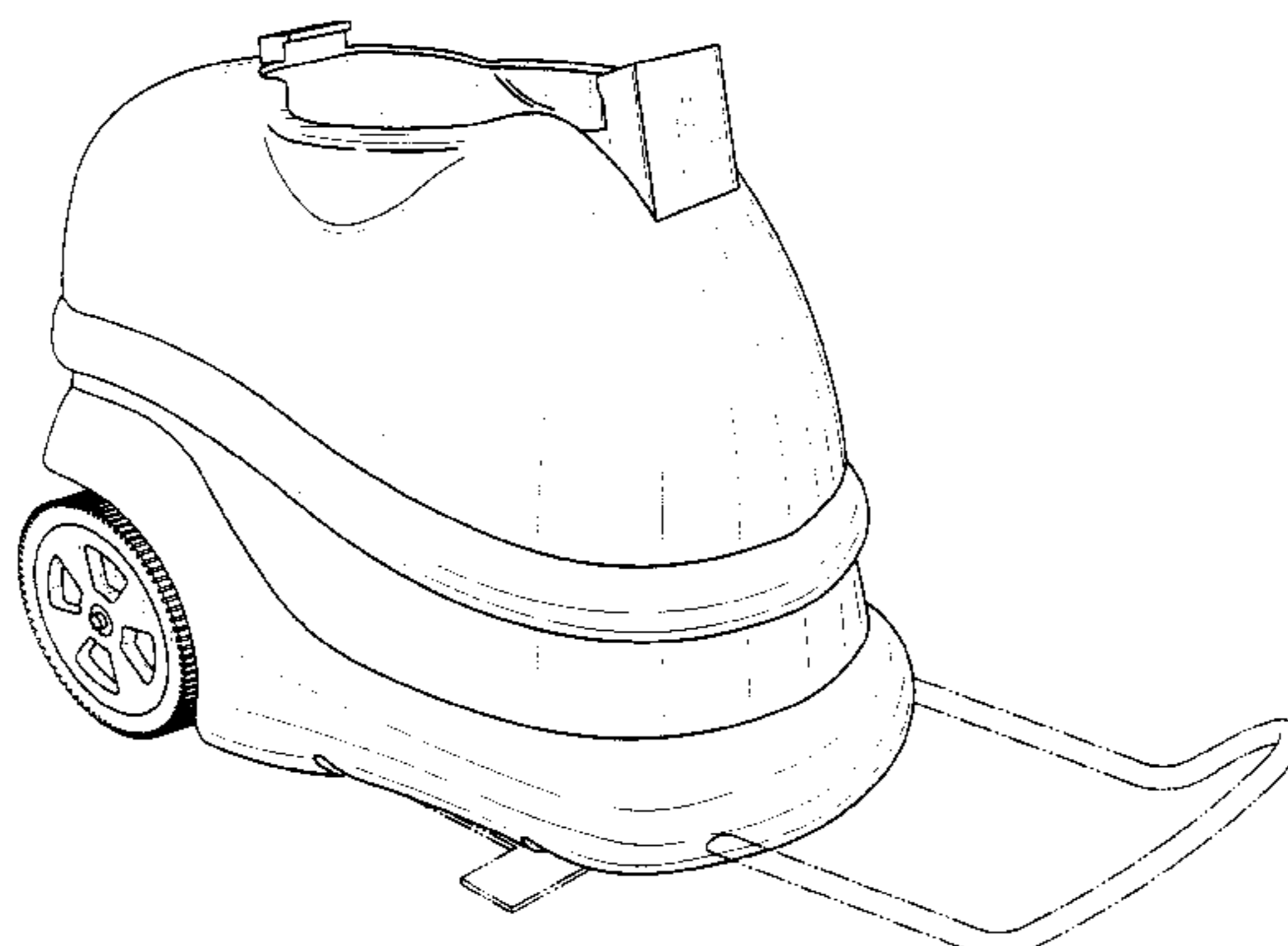
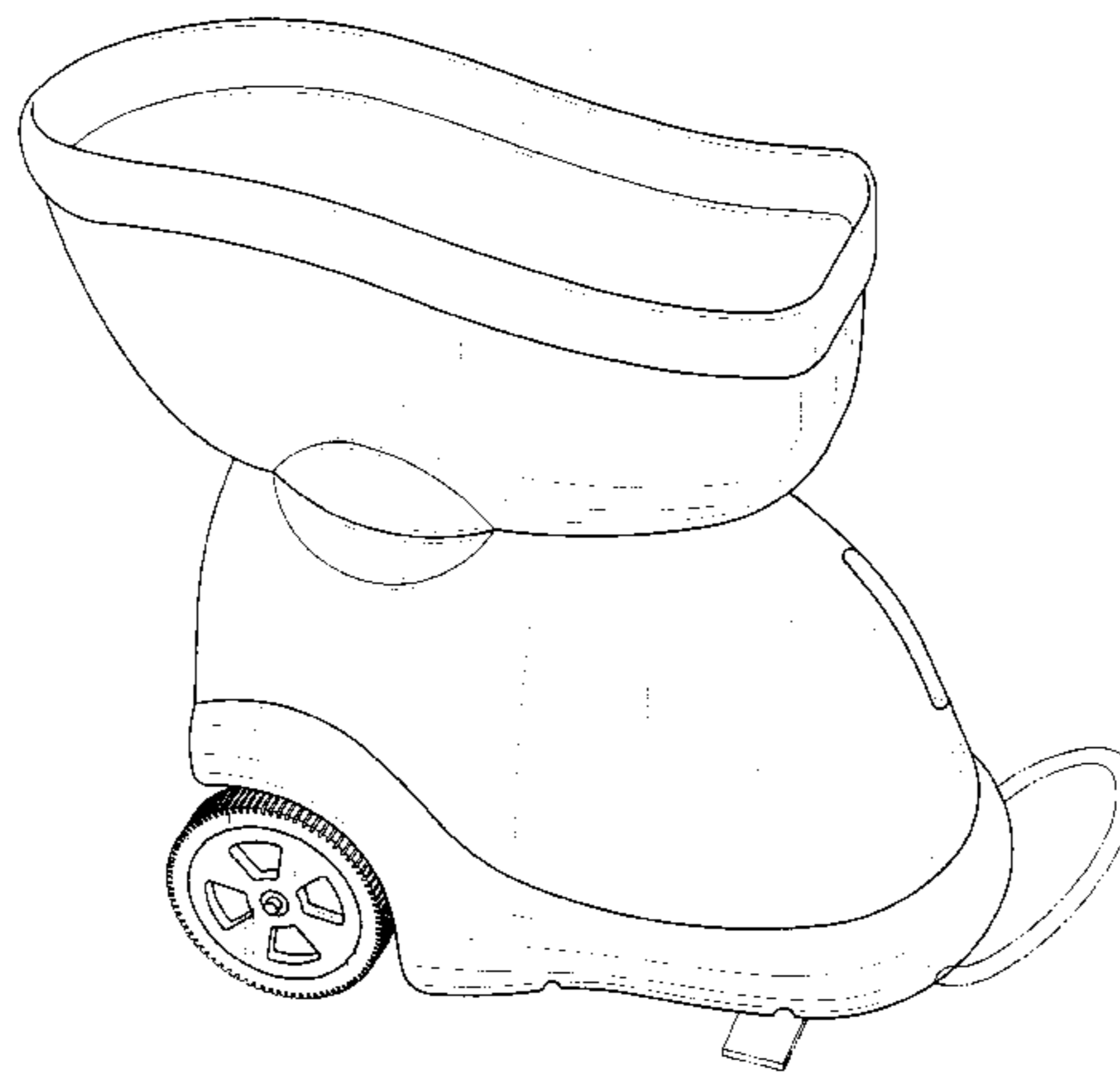

FIG. 1

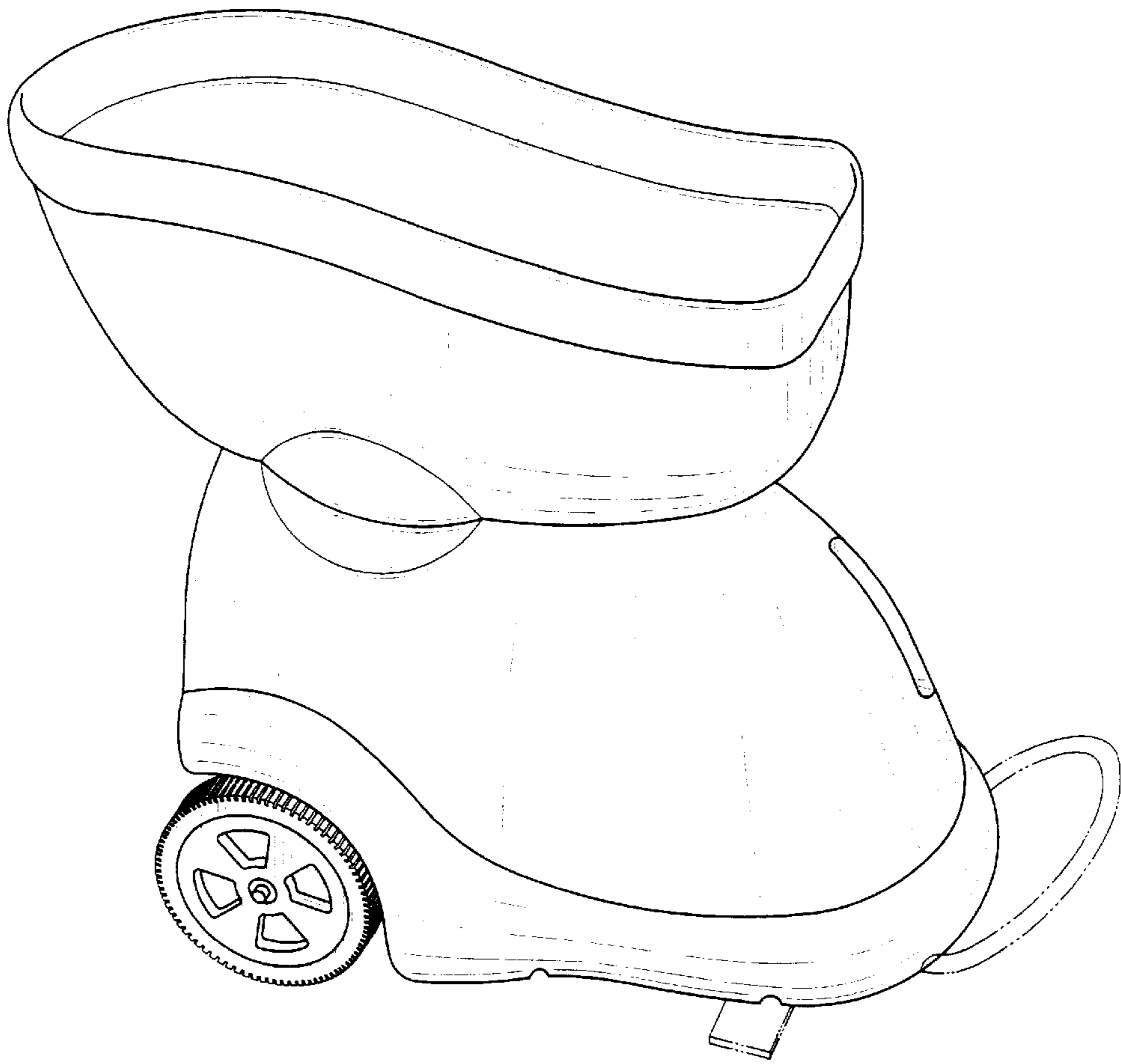

FIG. 2

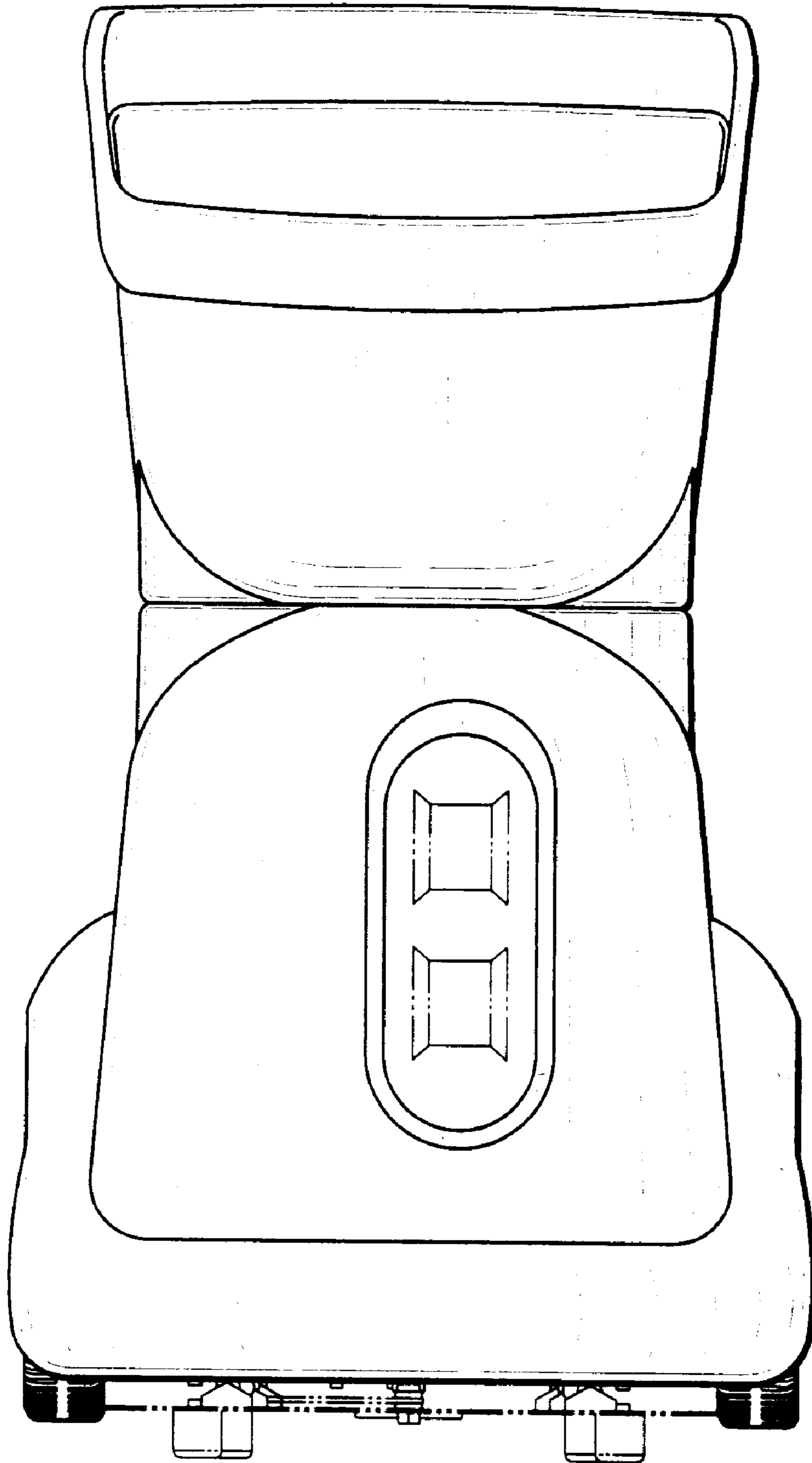

FIG. 3

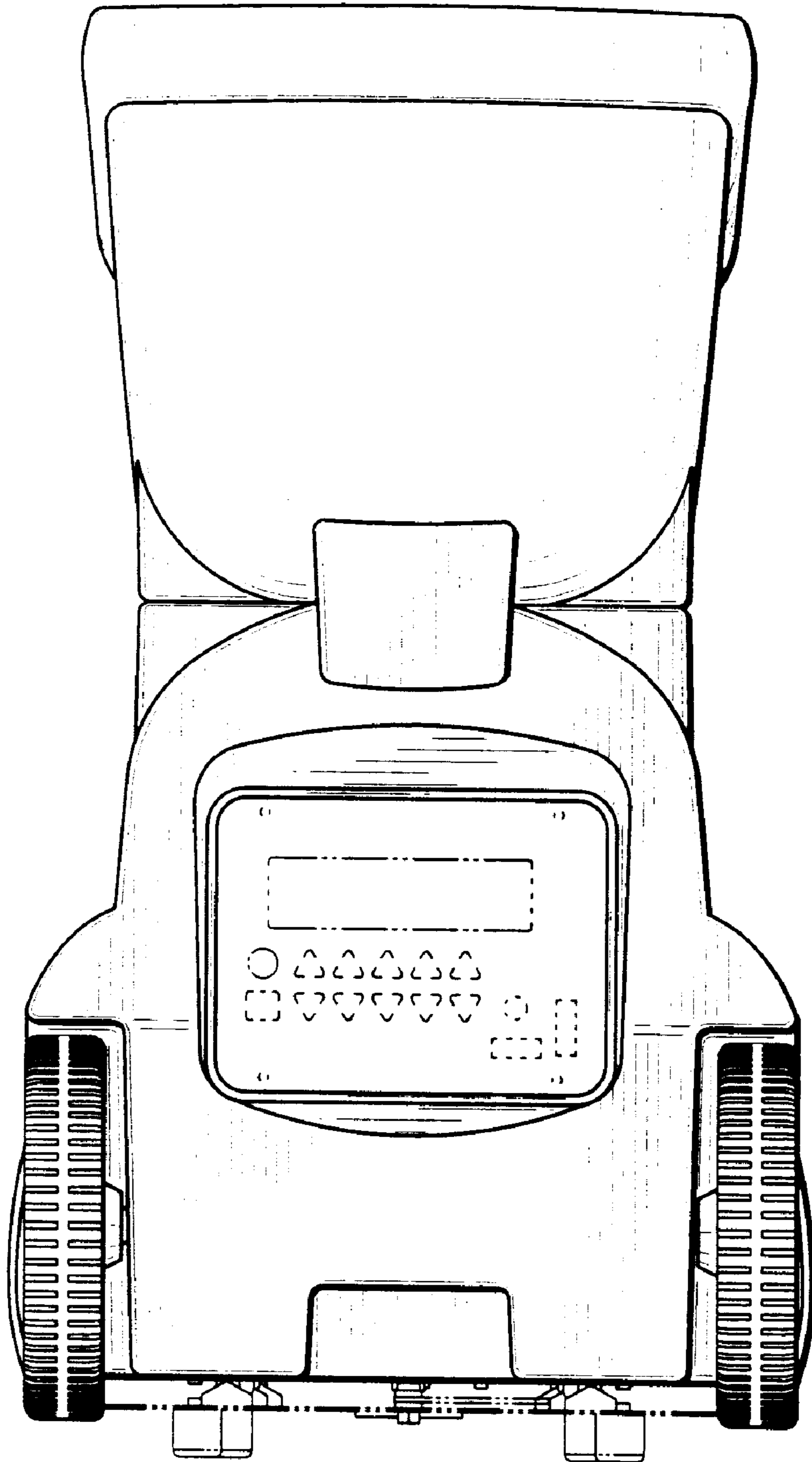

FIG. 4

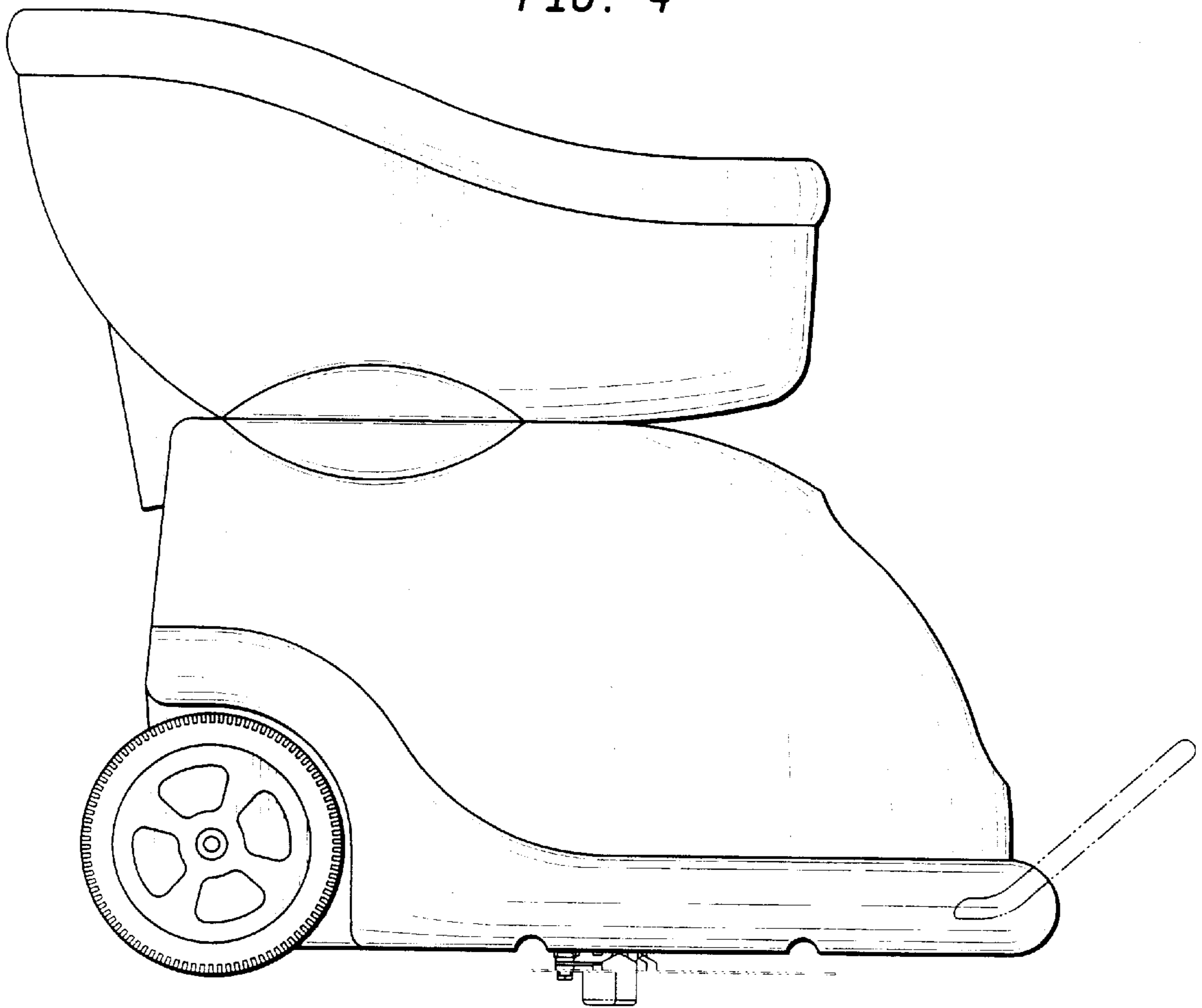

FIG. 5

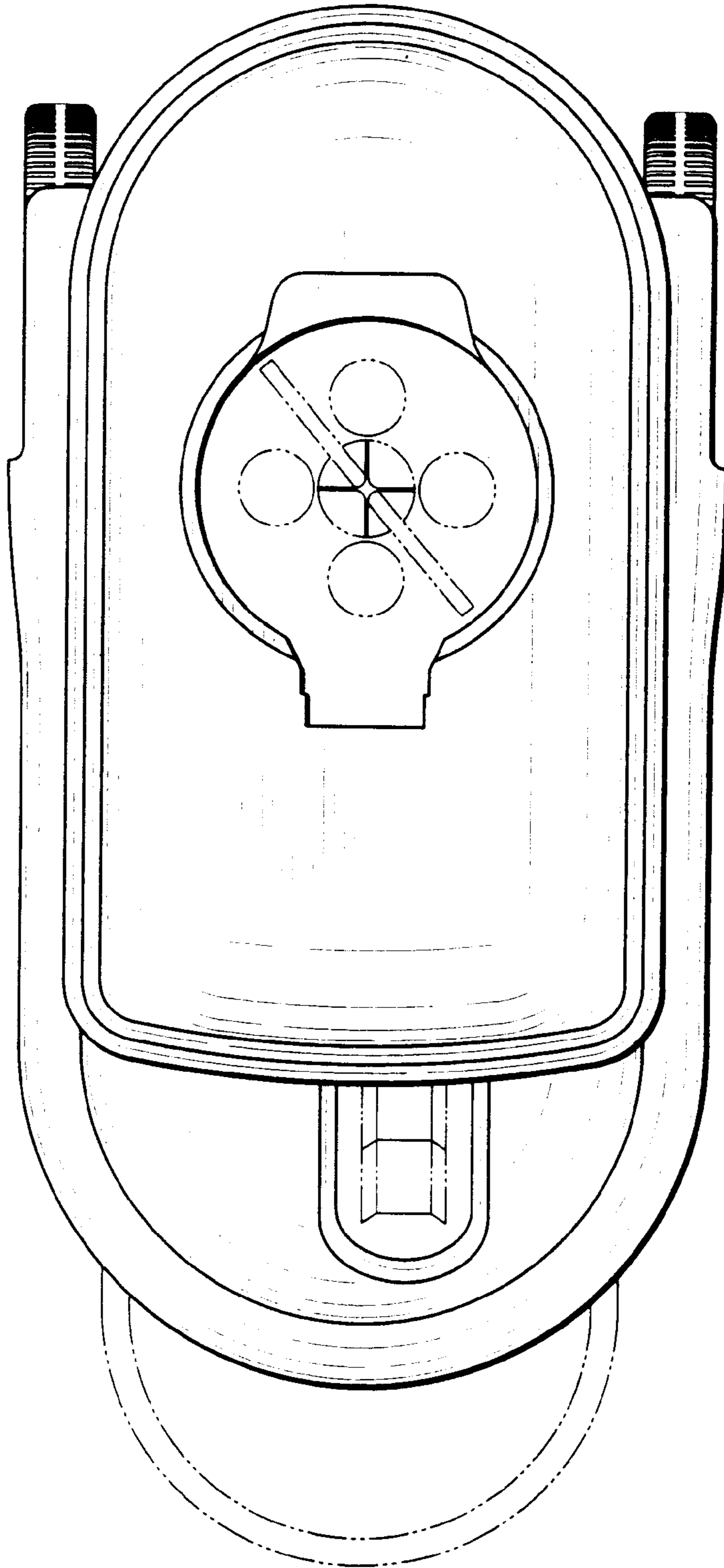

FIG. 6

