



US00D456743S

(12) **United States Design Patent** (10) **Patent No.:** **US D456,743 S**
Uehara et al. (45) **Date of Patent:** **** May 7, 2002**

(54) **BUCKLE**

(75) Inventors: **Ryoichiro Uehara**, Kurobe; **Hiroshi Matoba**, Toyama, both of (JP)

(73) Assignee: **YKK Corporation**, Tokyo (JP)

(**) Term: **14 Years**

(21) Appl. No.: **29/139,264**

(22) Filed: **Mar. 28, 2001**

(30) **Foreign Application Priority Data**

Sep. 29, 2000 (JP) 2000-027468

(51) **LOC (7) Cl.** **02-07**

(52) **U.S. Cl.** **D11/218**

(58) **Field of Search** D11/200, 201,
D11/215-218, 231, 234; 24/196, 616, 625,
650

(56) **References Cited**

U.S. PATENT DOCUMENTS

- 5,113,556 A * 5/1992 Murai et al. 24/633
- 5,548,879 A * 8/1996 Wu 24/625
- D387,014 S * 12/1997 Matoba D11/218
- D387,307 S * 12/1997 Matoba D11/218
- 5,953,798 A * 9/1999 Matoba et al. 24/615

* cited by examiner

Primary Examiner—Ralf Seifert

(74) *Attorney, Agent, or Firm*—Finnegan, Henderson, Farabow, Garrett & Dunner LLP

(57) **CLAIM**

The ornamental design for a buckle, as shown and described.

DESCRIPTION

FIG. 1 is a front view of a buckle according to the present invention.

FIG. 2 is a plan view of the buckle of FIG. 1.
 FIG. 3 is a right side view of the buckle of FIG. 1.
 FIG. 4 is a rear view of the buckle of FIG. 1.
 FIG. 5 is a base view of the buckle of FIG. 1.
 FIG. 6 is a cross-sectional view taken on line 6—6 of FIG. 3.
 FIG. 7 is a cross-sectional view taken on line 7—7 of FIG. 1.
 FIG. 8 is a front view of a male member of the buckle of FIG. 1.
 FIG. 9 is a plan view of the male member of FIG. 8.
 FIG. 10 is a right side view of the male member of FIG. 8.
 FIG. 11 is a rear view of the male member of FIG. 8.
 FIG. 12 is a base view of the male member of FIG. 8.
 FIG. 13 is a cross-sectional view taken on line 13—13 of FIG. 8.
 FIG. 14 is a cross-sectional view taken on line 14—14 of FIG. 8.
 FIG. 15 is a cross-sectional view taken on line 15—15 of FIG. 8.
 FIG. 16 is a cross-sectional view taken on line 16—16 of FIG. 10.
 FIG. 17 is a front view of a female member of the buckle of FIG. 1.
 FIG. 18 is a plan view of the female member of FIG. 17.
 FIG. 19 is a right side view of the female member of FIG. 17.
 FIG. 20 is a rear view of the female member of FIG. 17.
 FIG. 21 is a base view of the female member of FIG. 17.
 FIG. 22 is a cross-sectional view taken on line 22—22 of FIG. 17.
 FIG. 23 is a cross-sectional view taken on line 23—23 of FIG. 17.
 FIG. 24 is a cross-sectional view taken on line 24—24 of FIG. 19; and,
 FIG. 25 is an explanatory view showing the buckle of FIG. 1 in use.
 The broken line showing in FIG. 25 is for illustrative purposes only and forms no part of the claimed design.

1 Claim, 10 Drawing Sheets

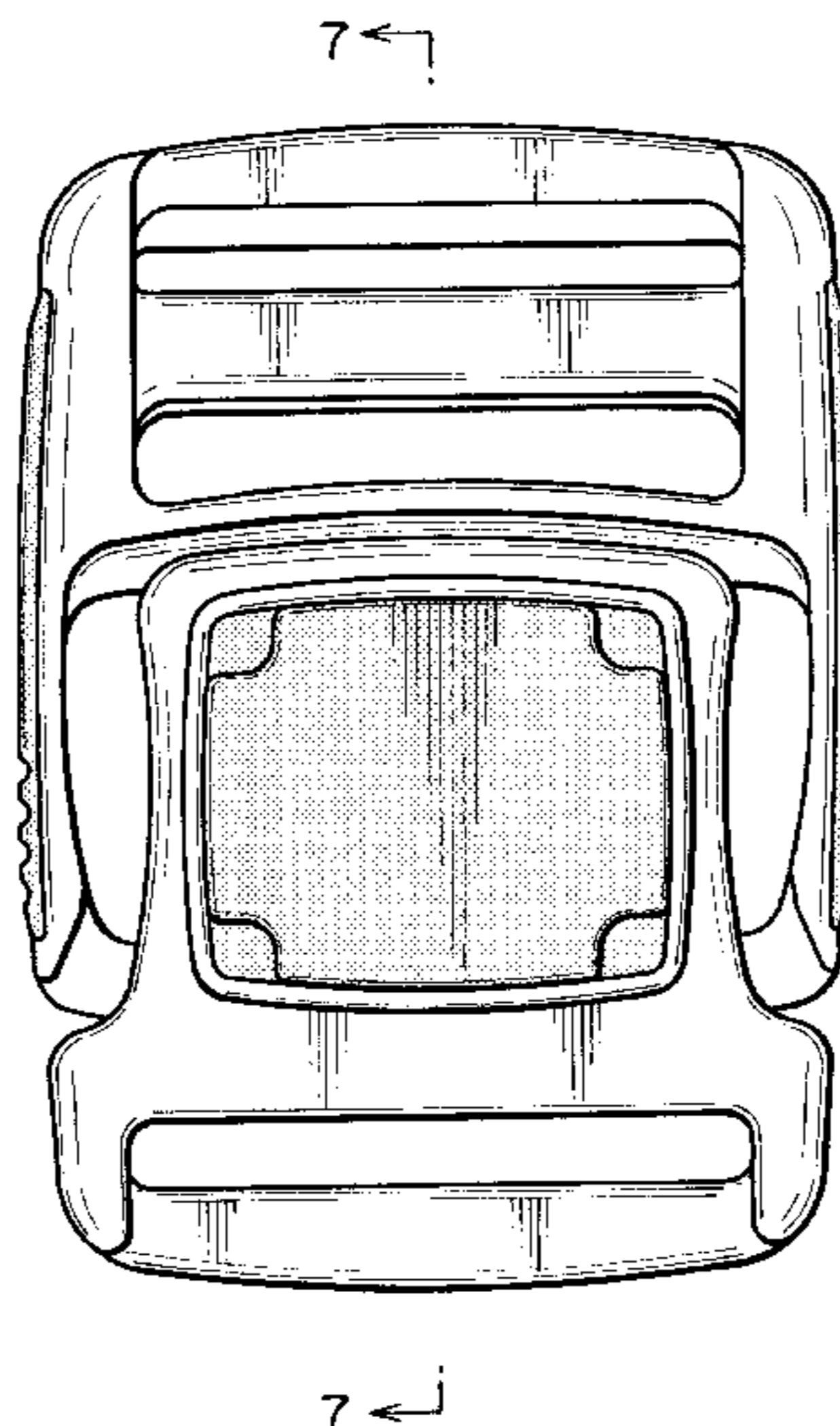

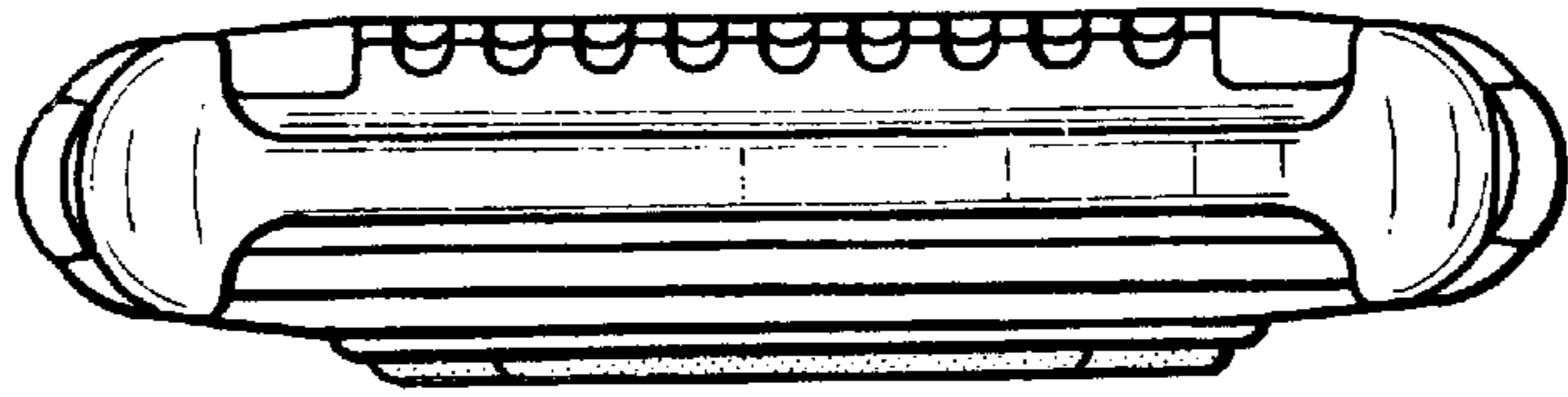
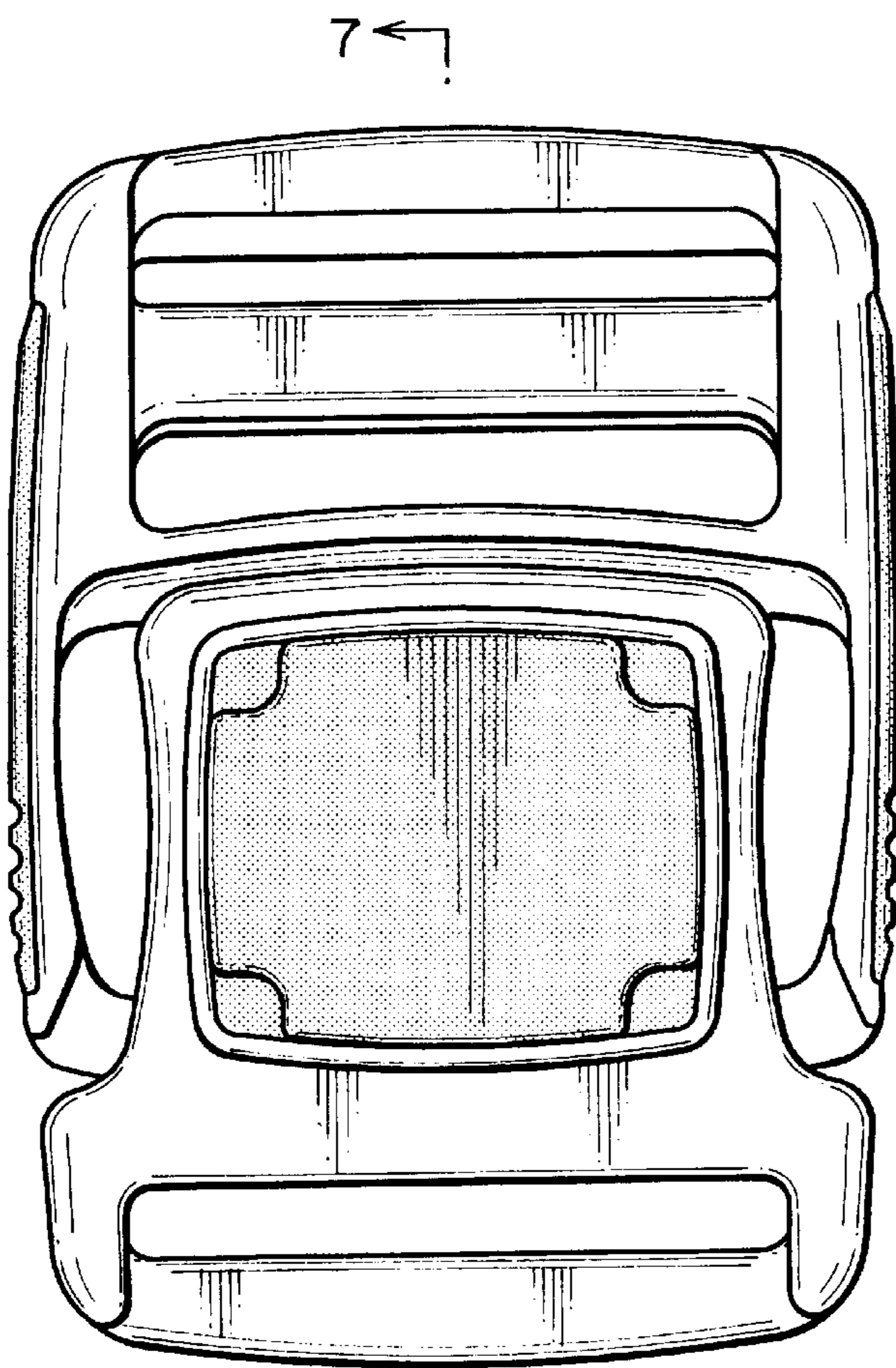
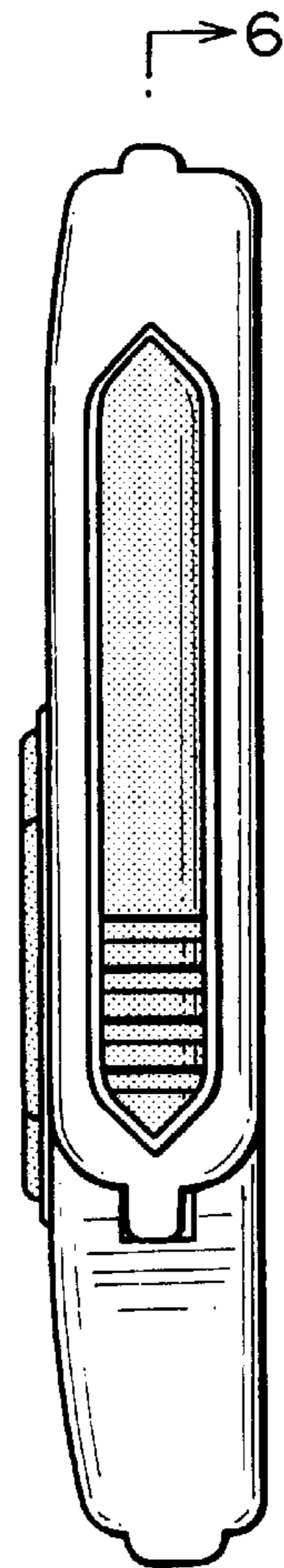

FIG. 2



7 ←

FIG. 1



6 →

FIG. 3

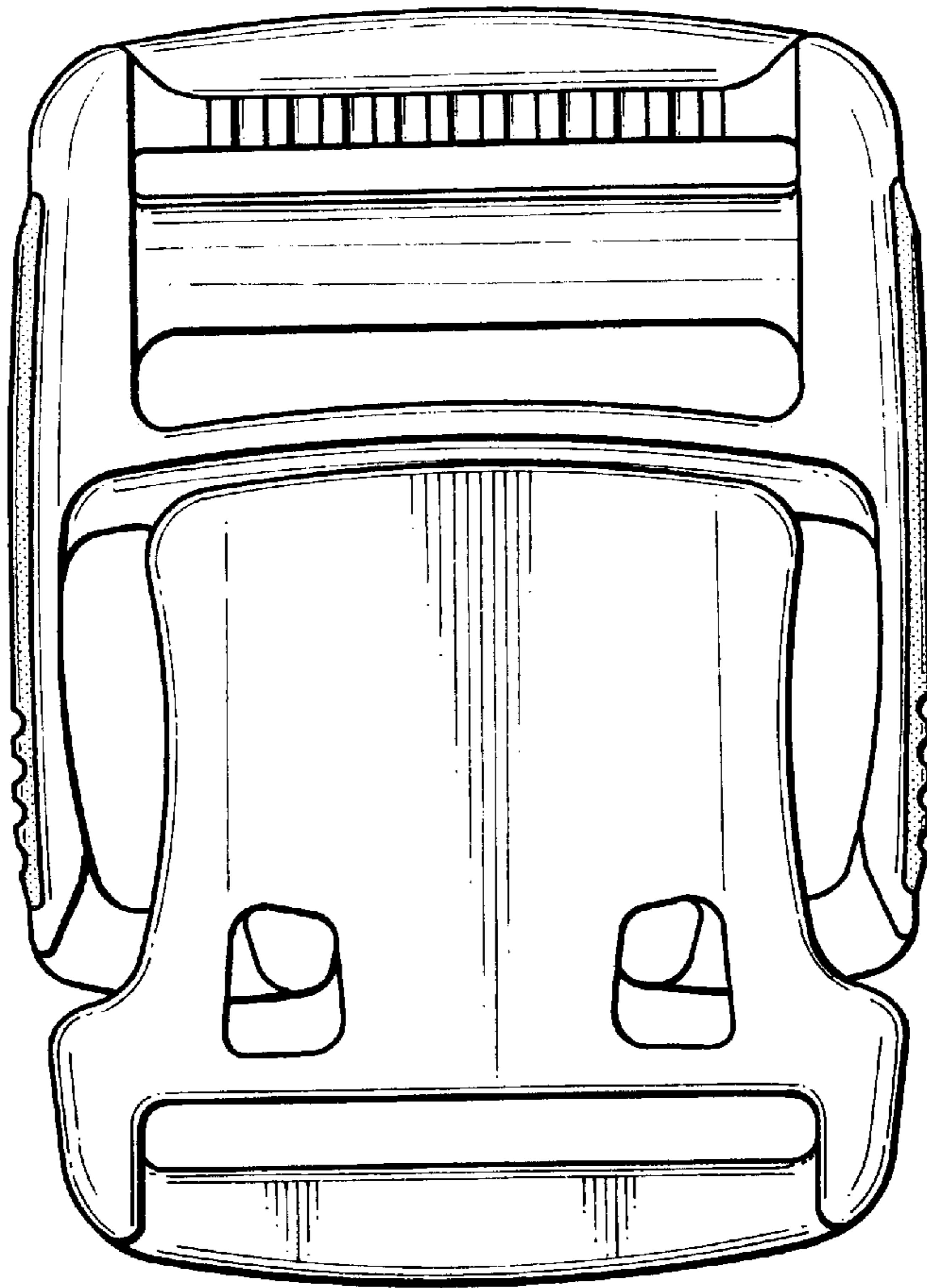

FIG. 4

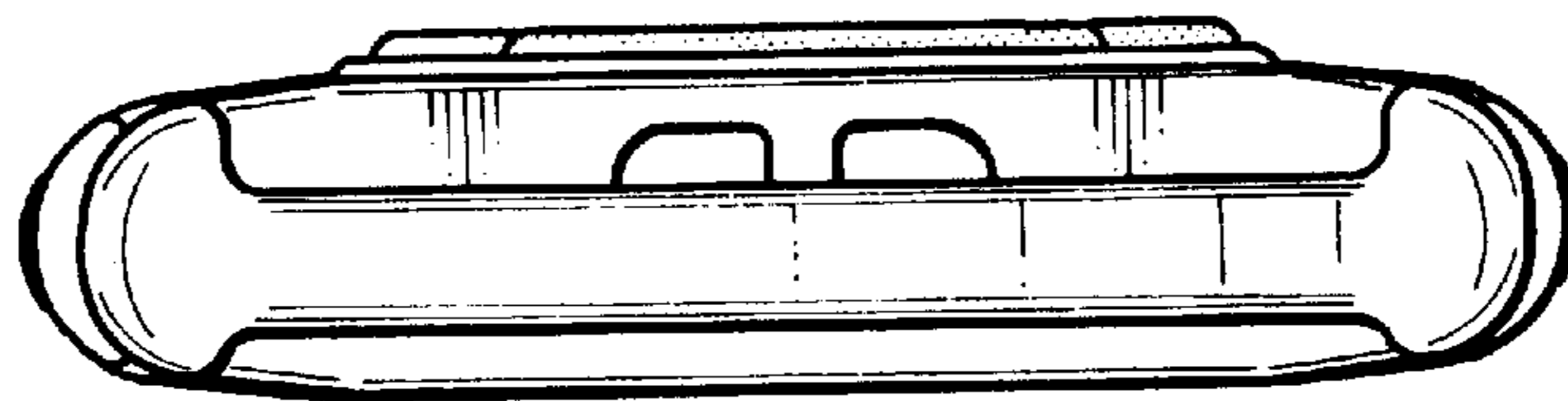

FIG. 5

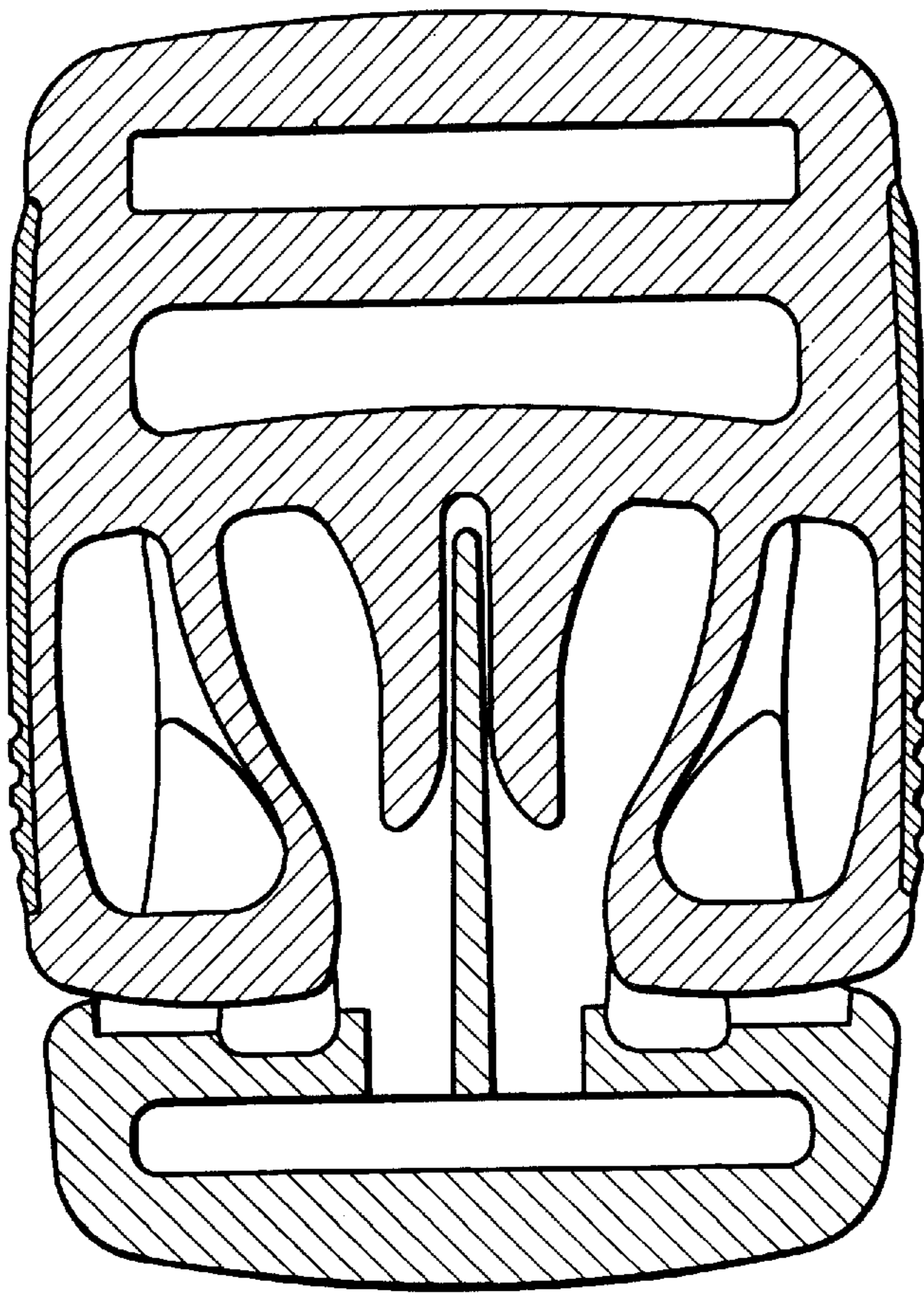

FIG. 6

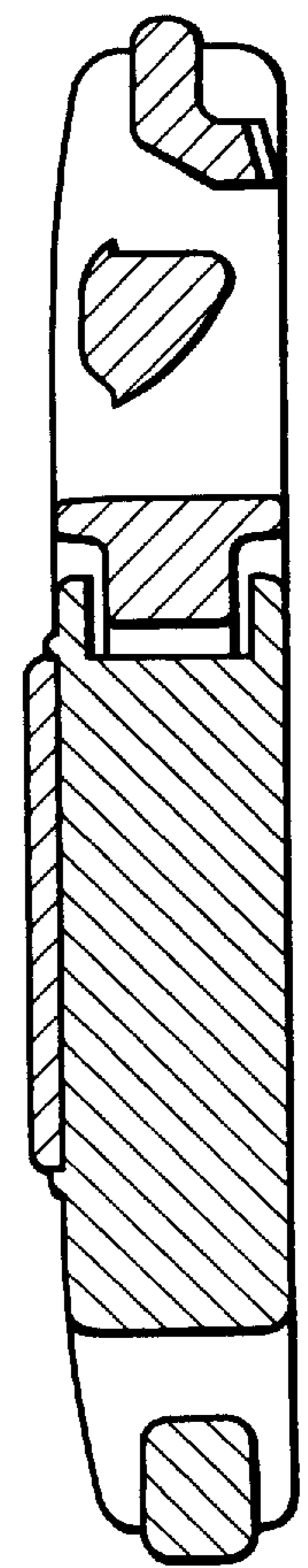

FIG. 7

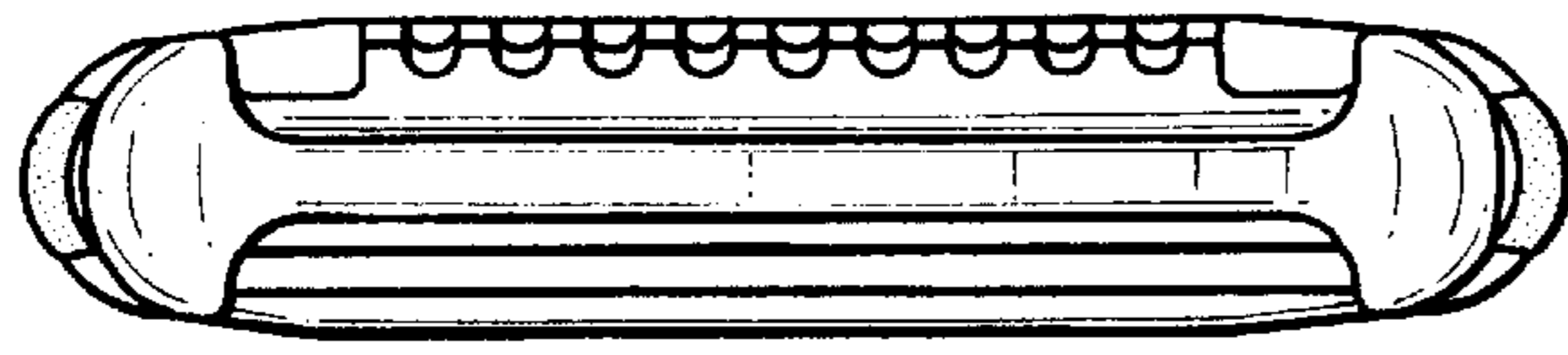

FIG. 9

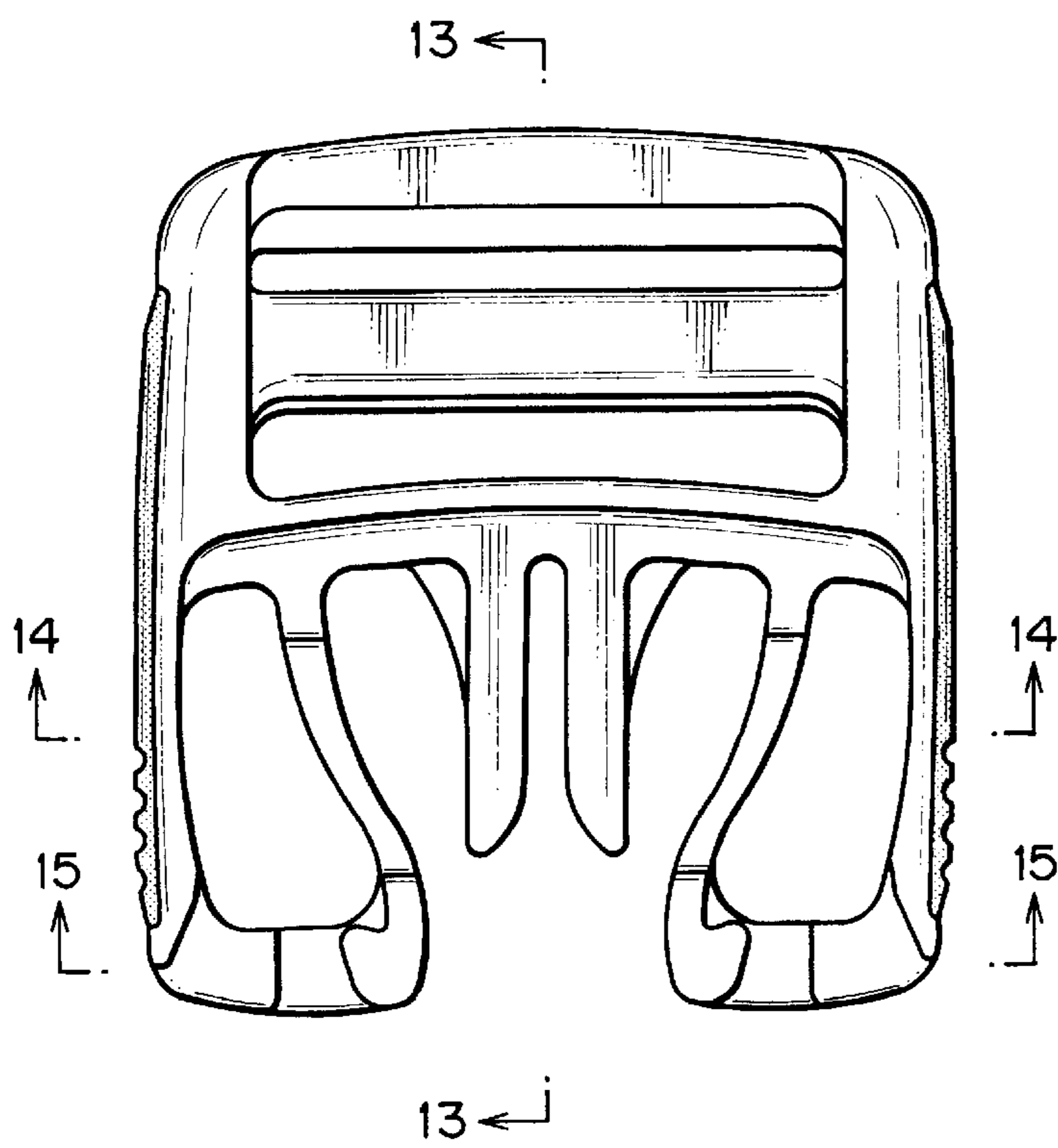

FIG. 8

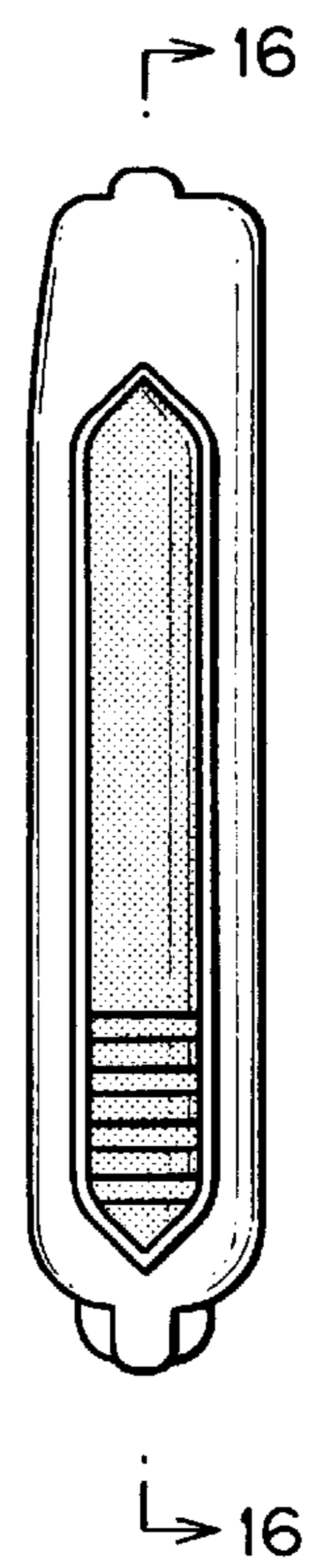

FIG. 10

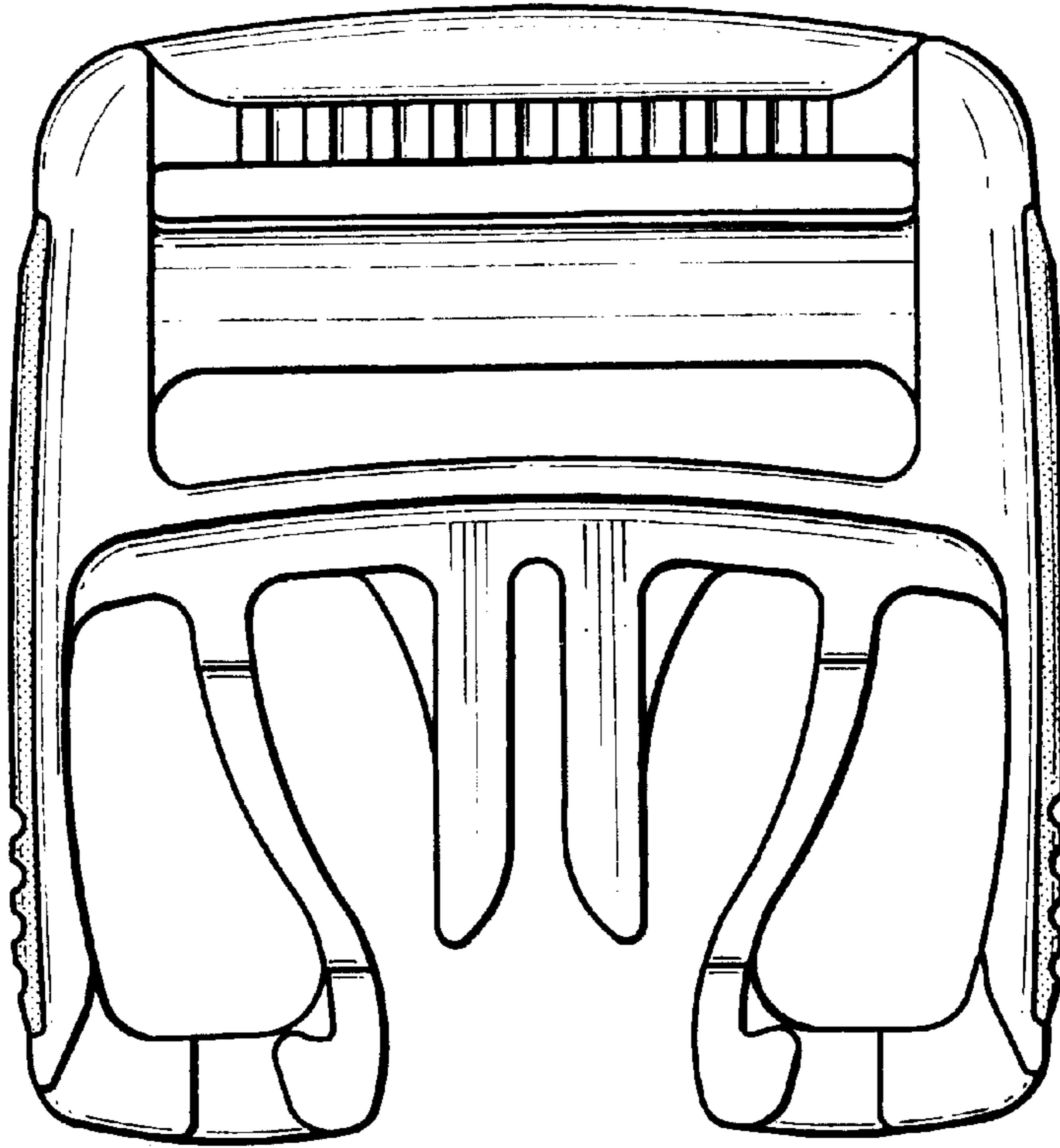

FIG. 11



FIG. 12

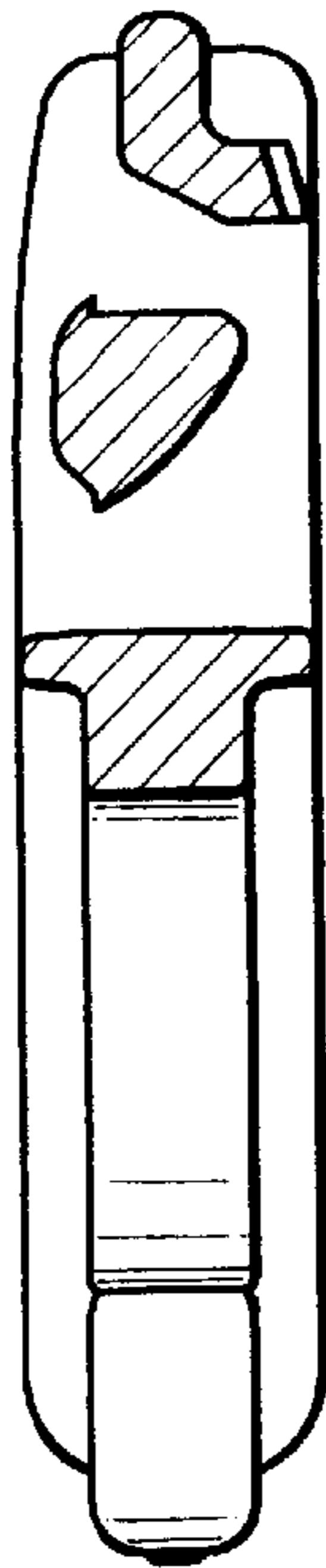

FIG. 13

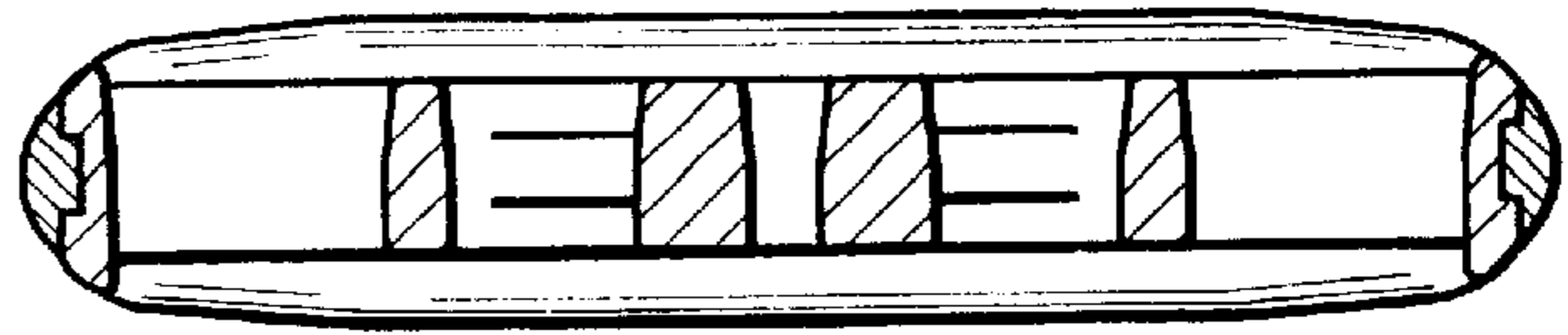

FIG. 14

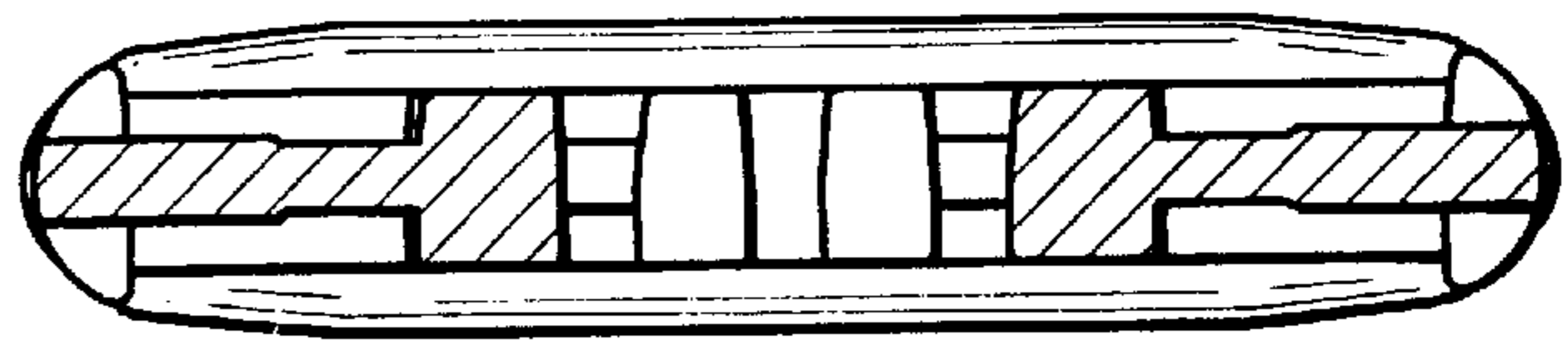

FIG. 15

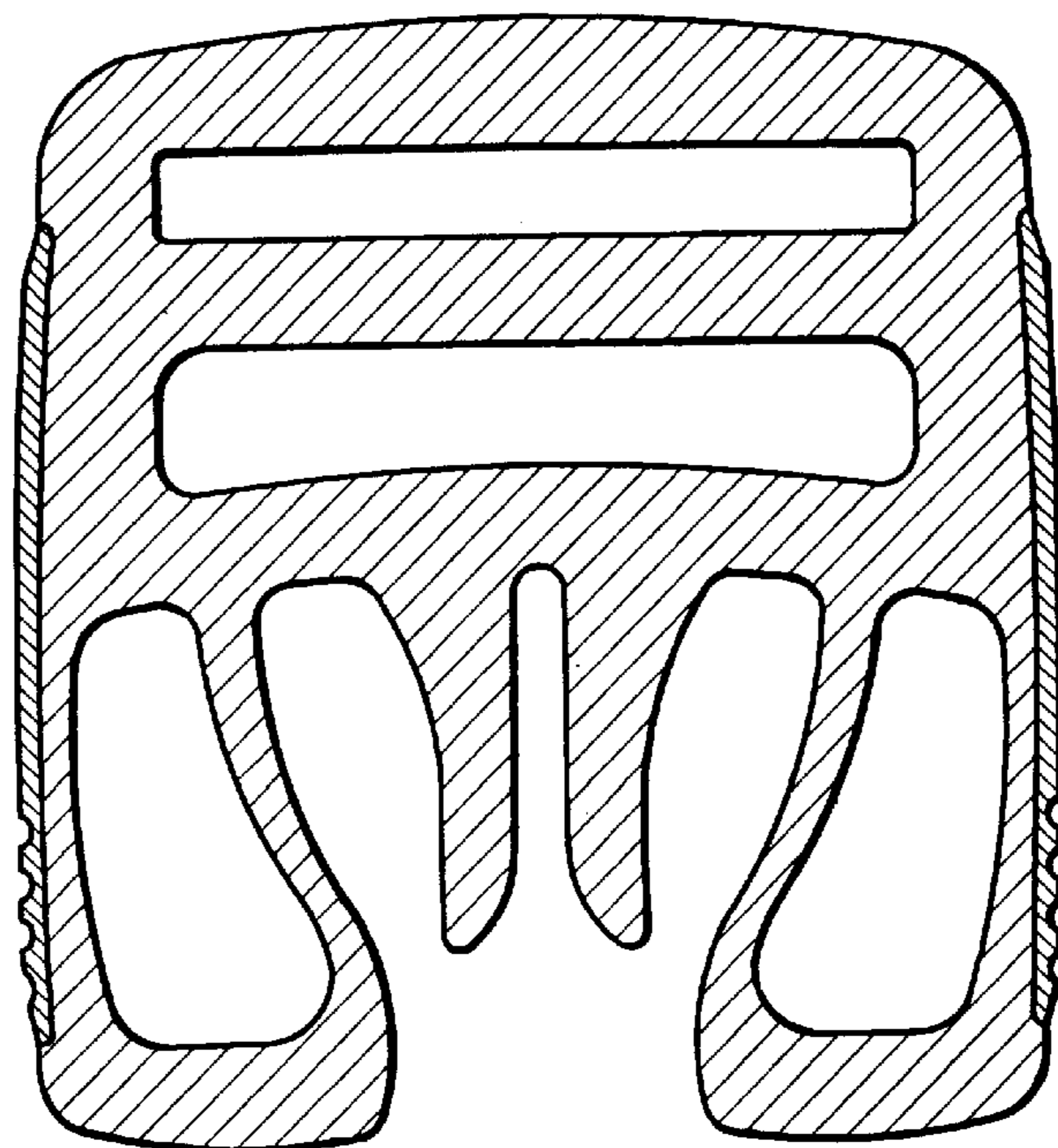

FIG. 16

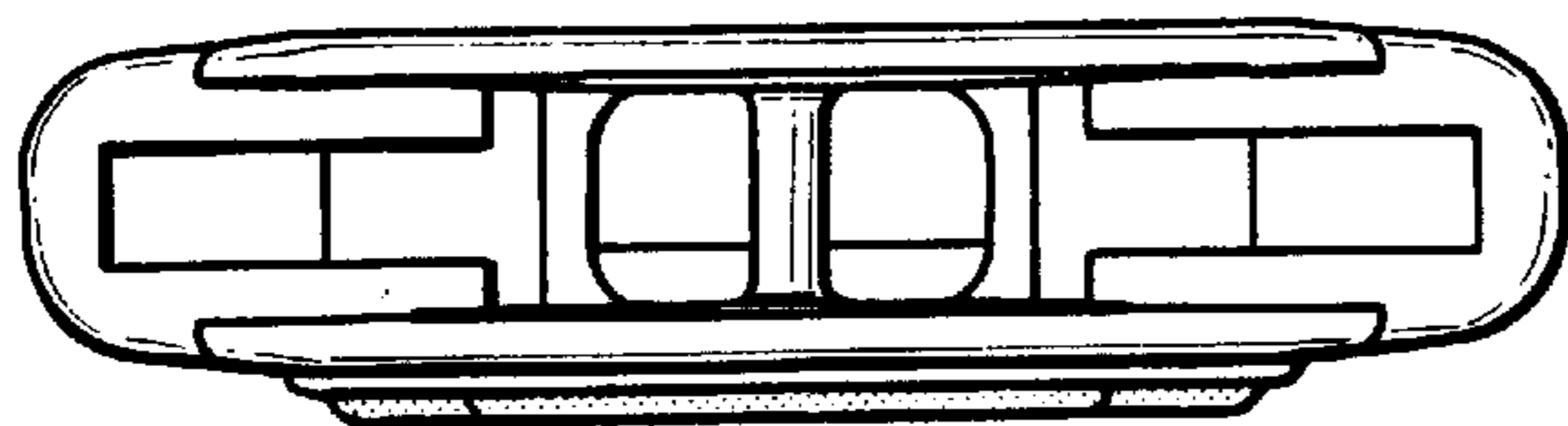

FIG. 18

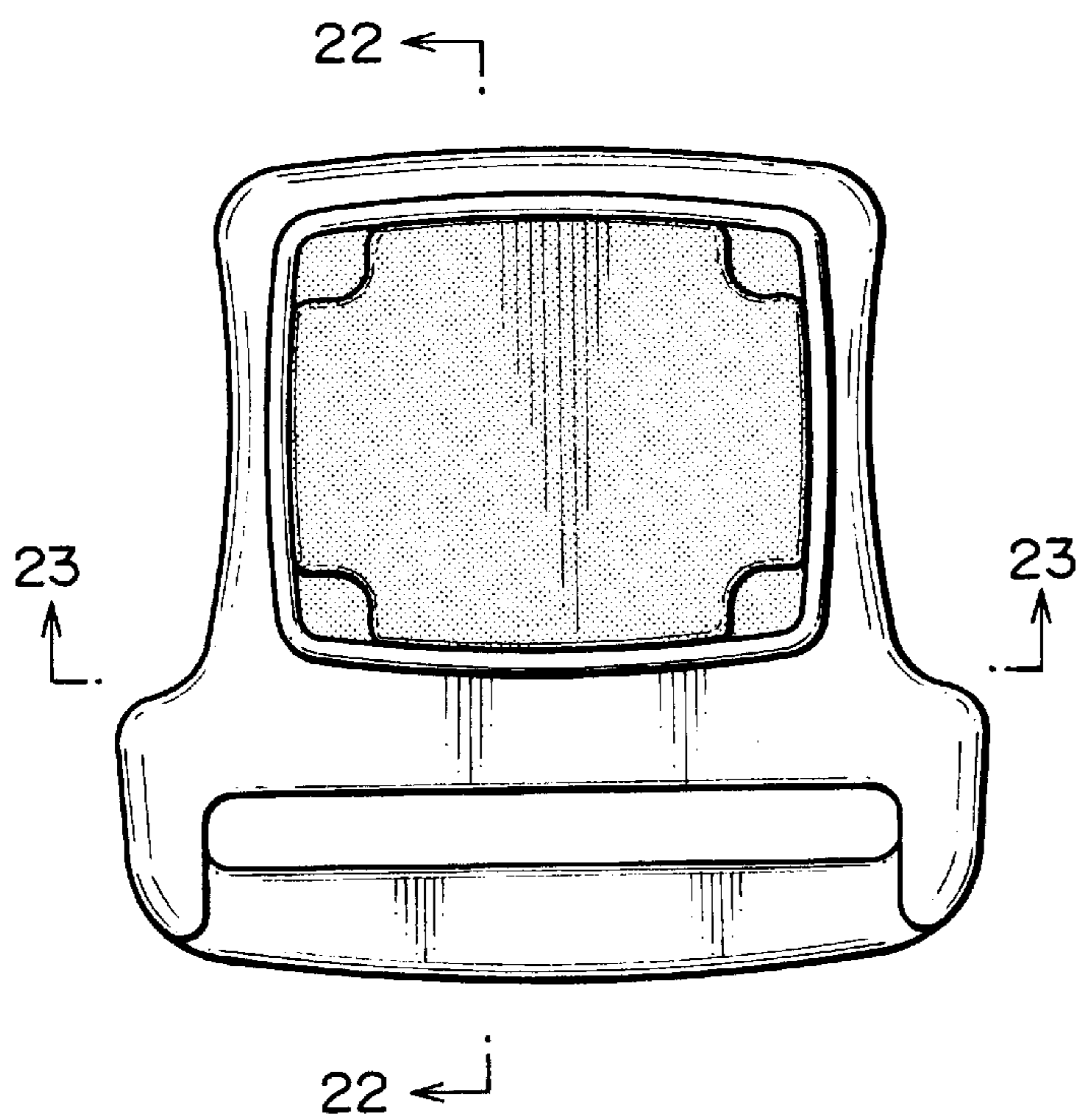

FIG. 17

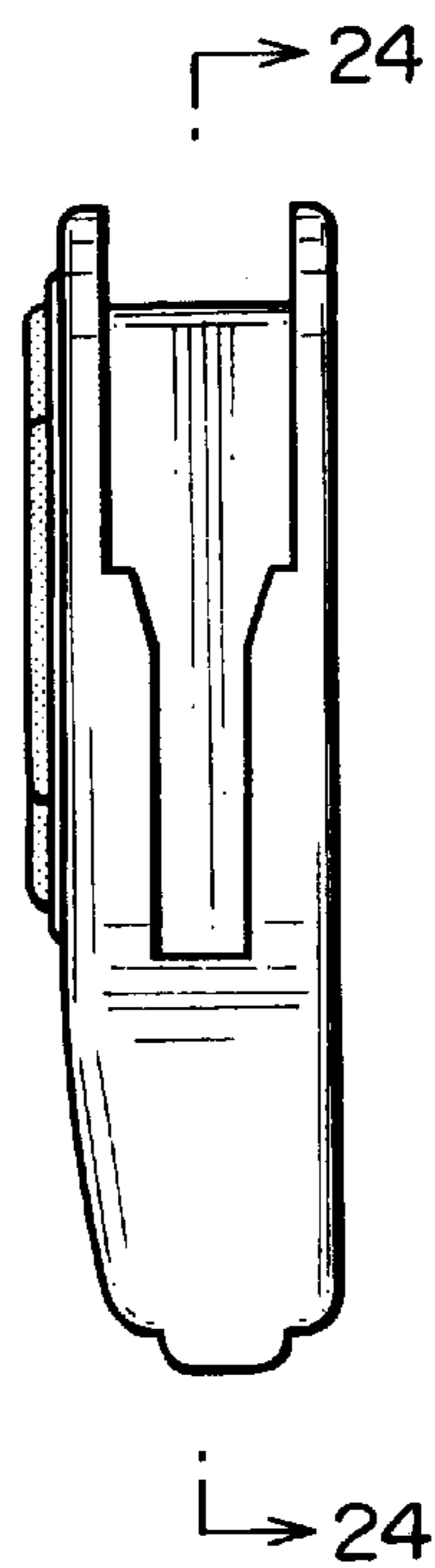

FIG. 19

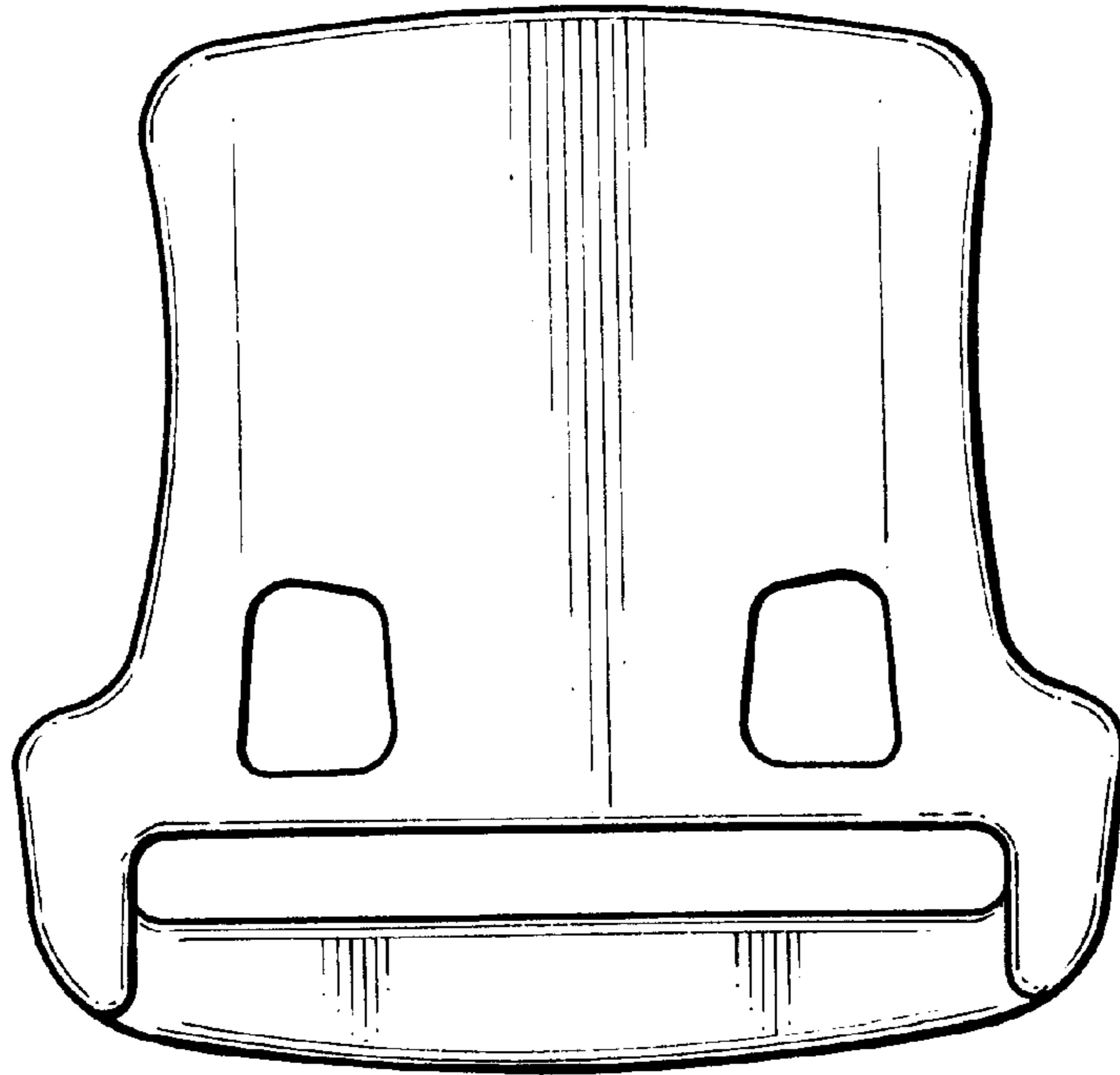

FIG. 20

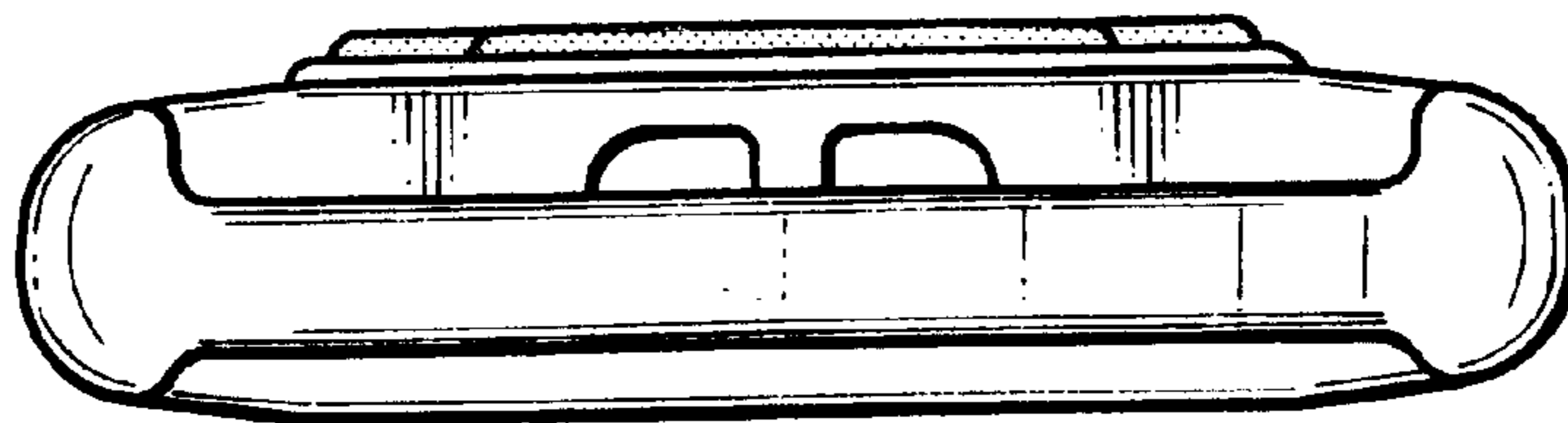

FIG. 21

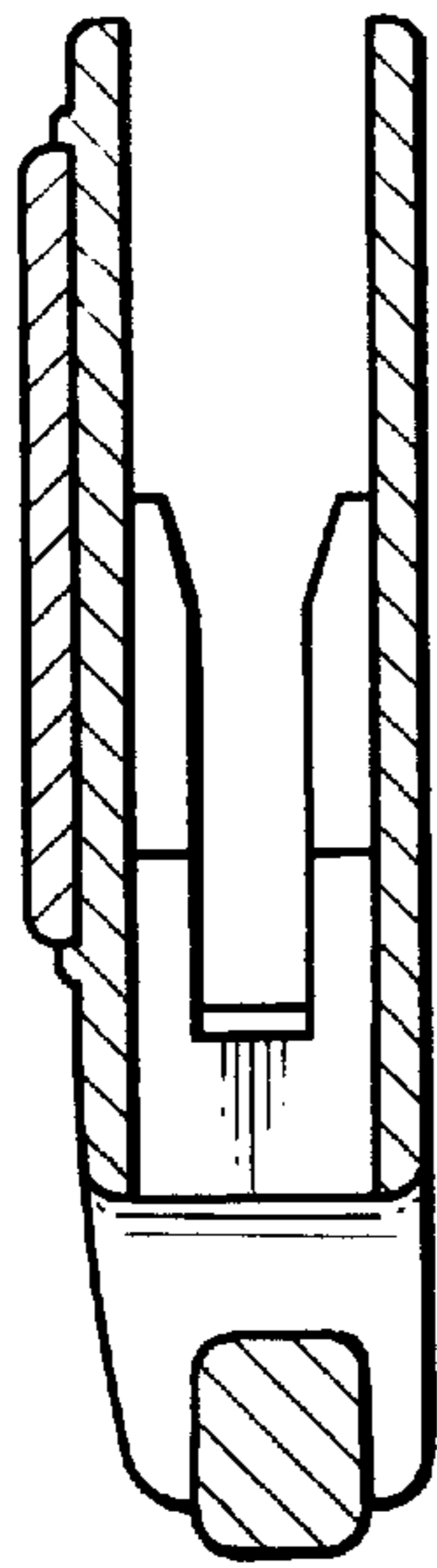

FIG. 22

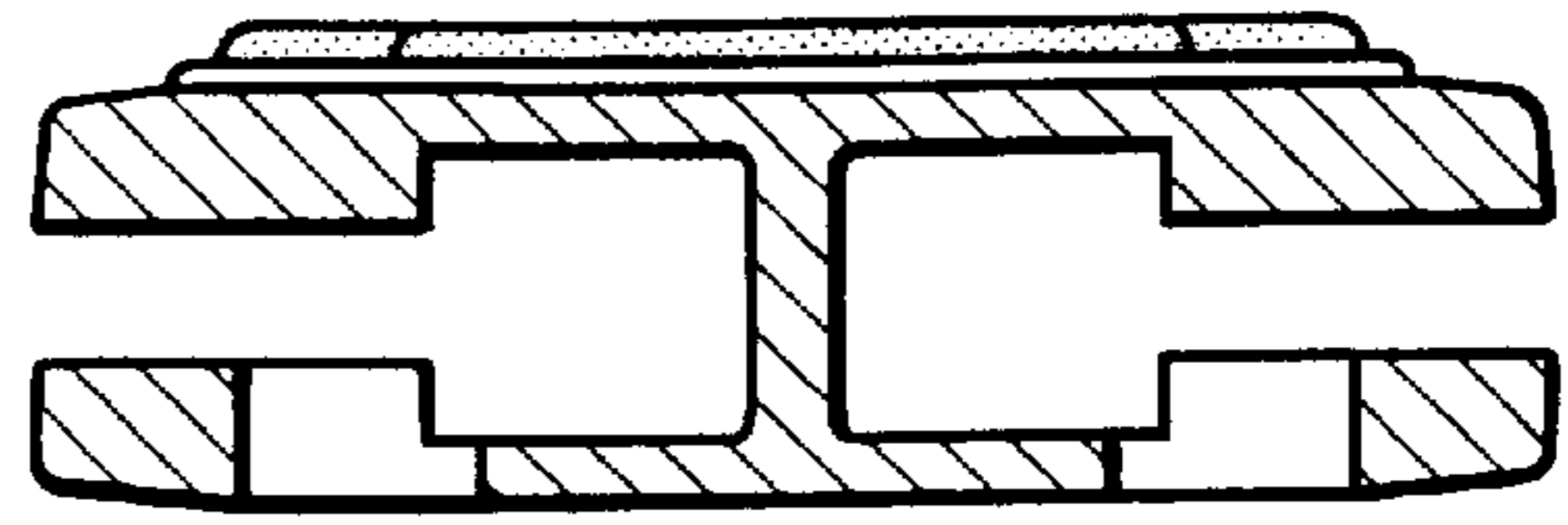

FIG. 23

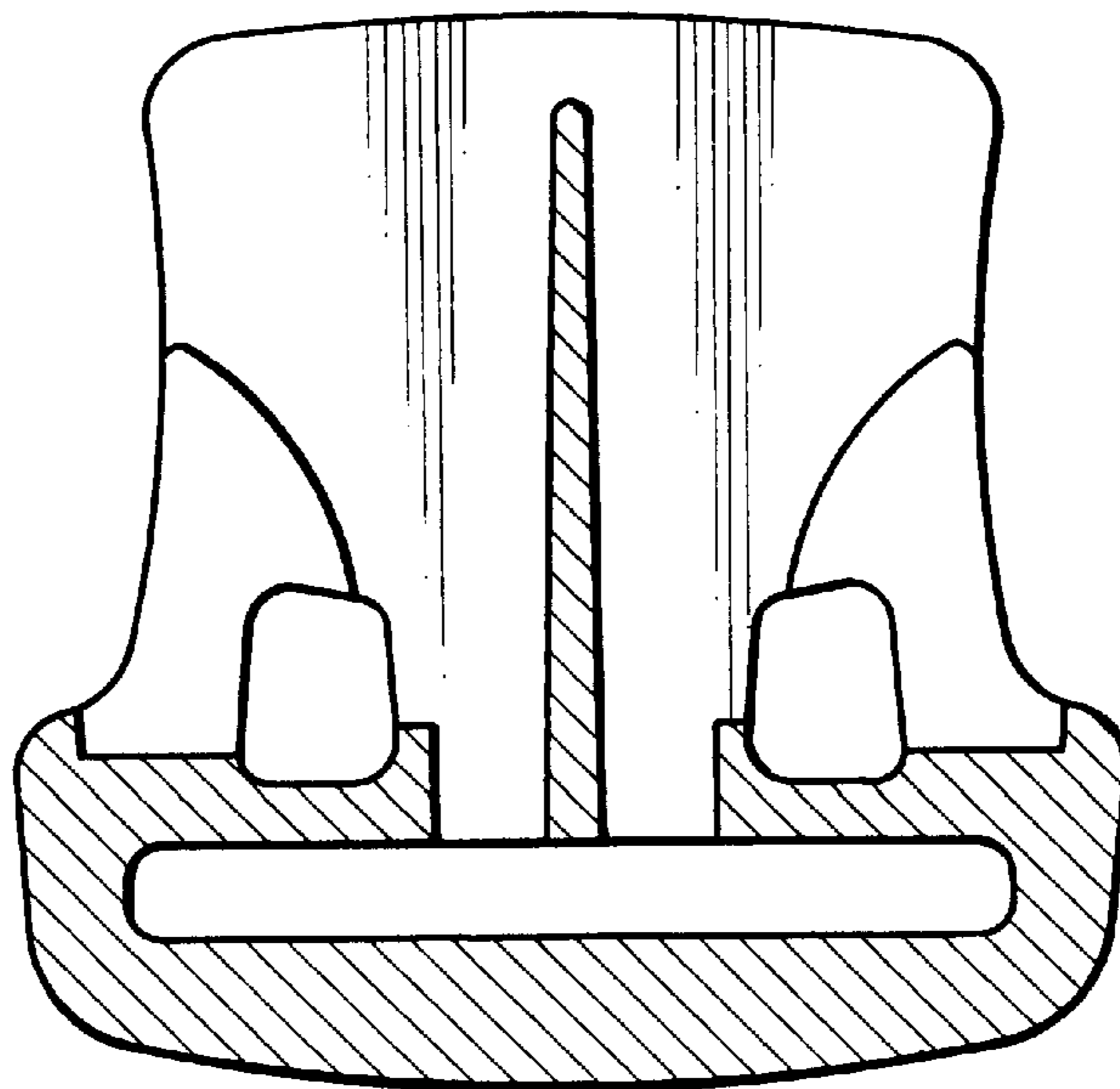

FIG. 24

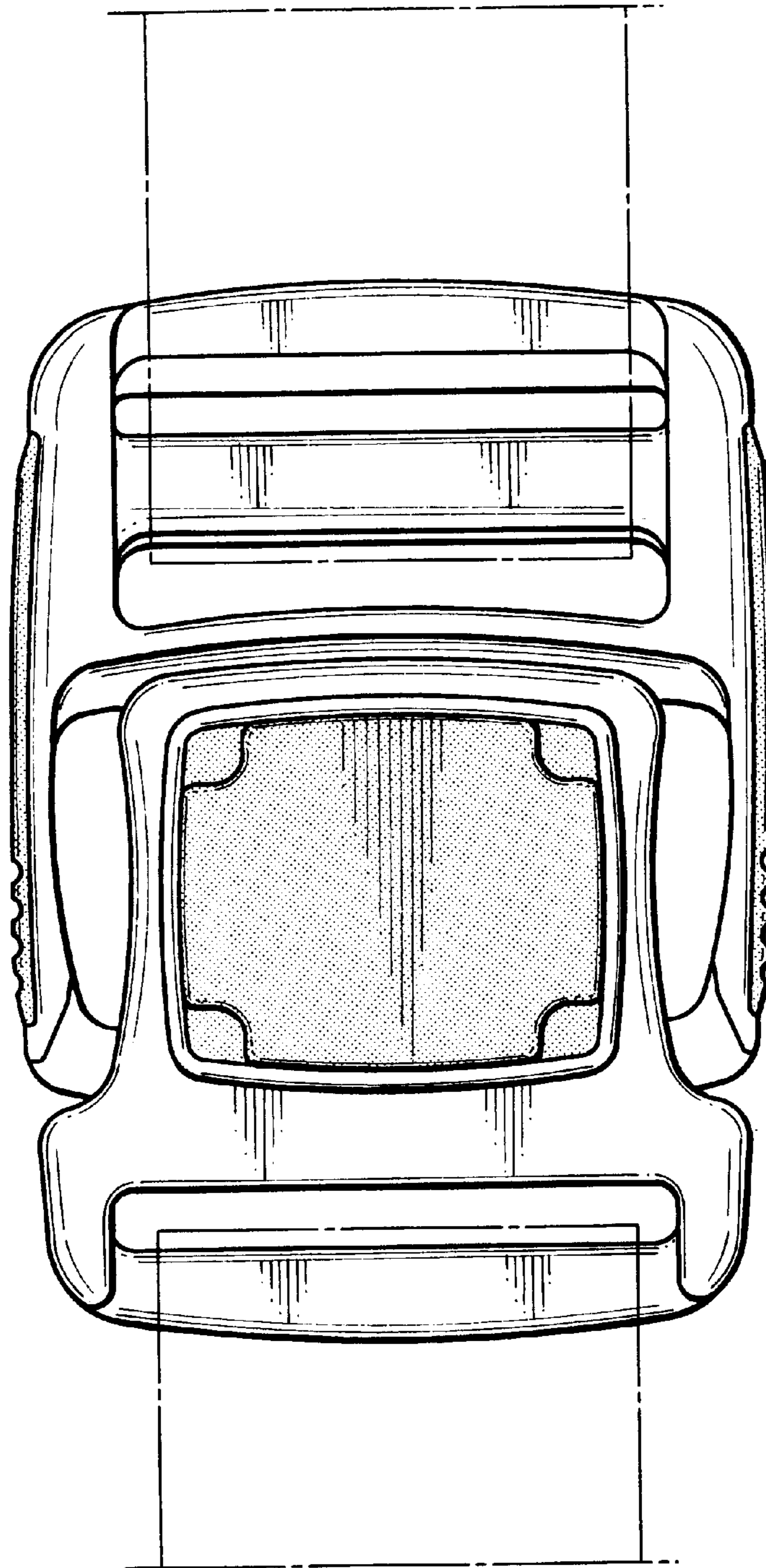

FIG. 25