



US00D456720S

(12) **United States Design Patent**
Brzezinski

(10) **Patent No.:** **US D456,720 S**

(45) **Date of Patent:** **** May 7, 2002**

(54) **CASING FOR A WATCH**

D395,401 S * 6/1998 Toribio D10/30

(75) Inventor: **Janet G. Brzezinski**, Southbury, CT
(US)

* cited by examiner

(73) Assignee: **Timex Group B.V.** (NL)

Primary Examiner—Nelson C. Holtje

(74) *Attorney, Agent, or Firm*—Carmody & Torrance LLP

(**) Term: **14 Years**

(57) **CLAIM**

(21) Appl. No.: **29/144,858**

The ornamental design for a casing for a watch, as shown and described.

(22) Filed: **Jul. 11, 2001**

DESCRIPTION

(51) **LOC (7) Cl.** **10-02**

FIG. 1 is a perspective view of a casing for a watch showing my new design;

(52) **U.S. Cl.** **D10/30**

FIG. 2 is a left side elevational view thereof;

(58) **Field of Search** D10/30-39, 122-132;
368/281-282, 276-277, 285

FIG. 3 is a top plan view thereof;

FIG. 4 is a right side elevational view thereof;

FIG. 5 is a first end elevational view thereof;

FIG. 6 is a second end elevational view thereof; and,

FIG. 7 is a bottom plan view.

(56) **References Cited**

U.S. PATENT DOCUMENTS

D321,664 S * 11/1991 Kennedy D10/30

D329,611 S * 9/1992 Burgener D10/30

D378,061 S * 2/1997 Ludvig D10/30

1 Claim, 3 Drawing Sheets

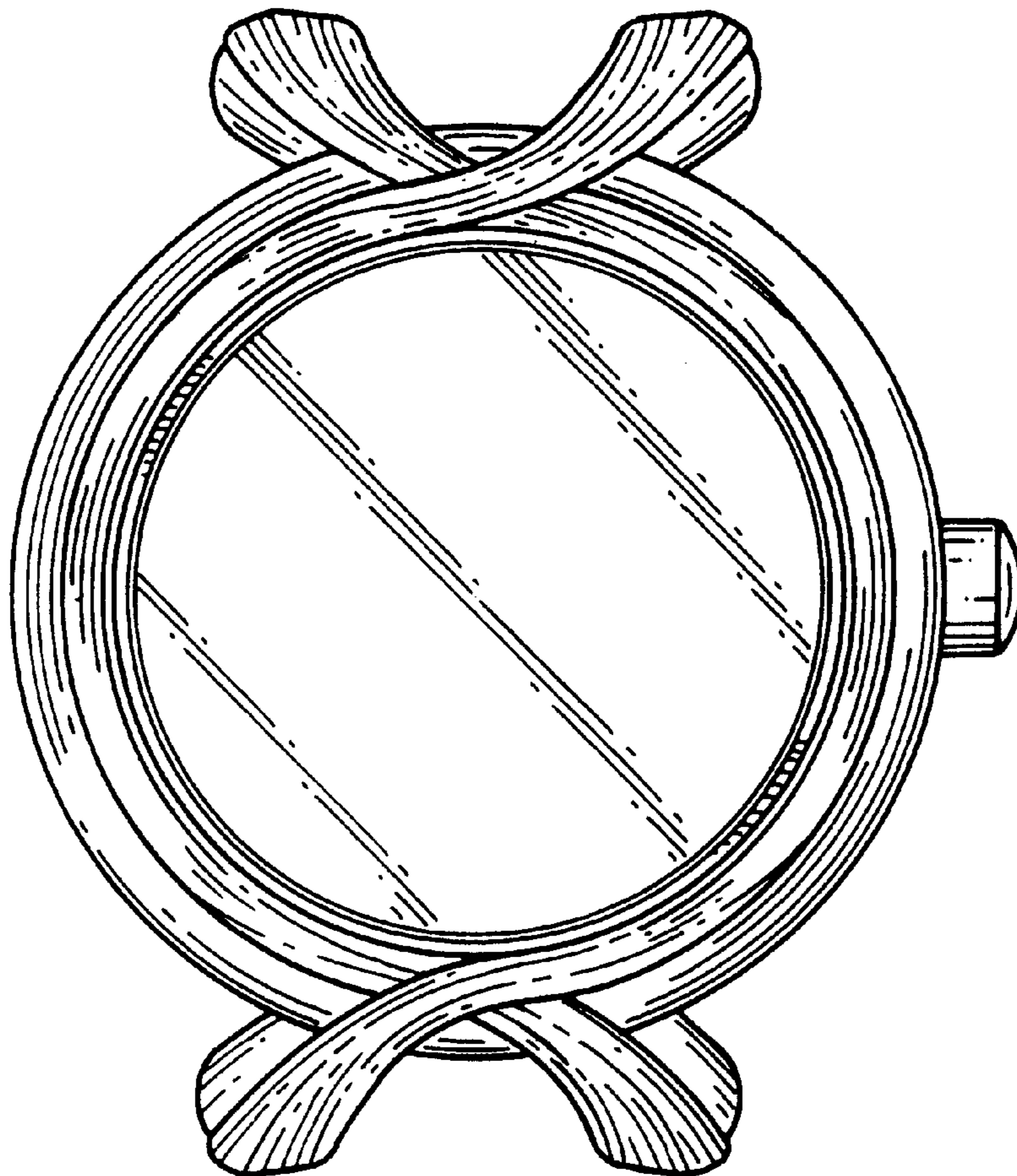

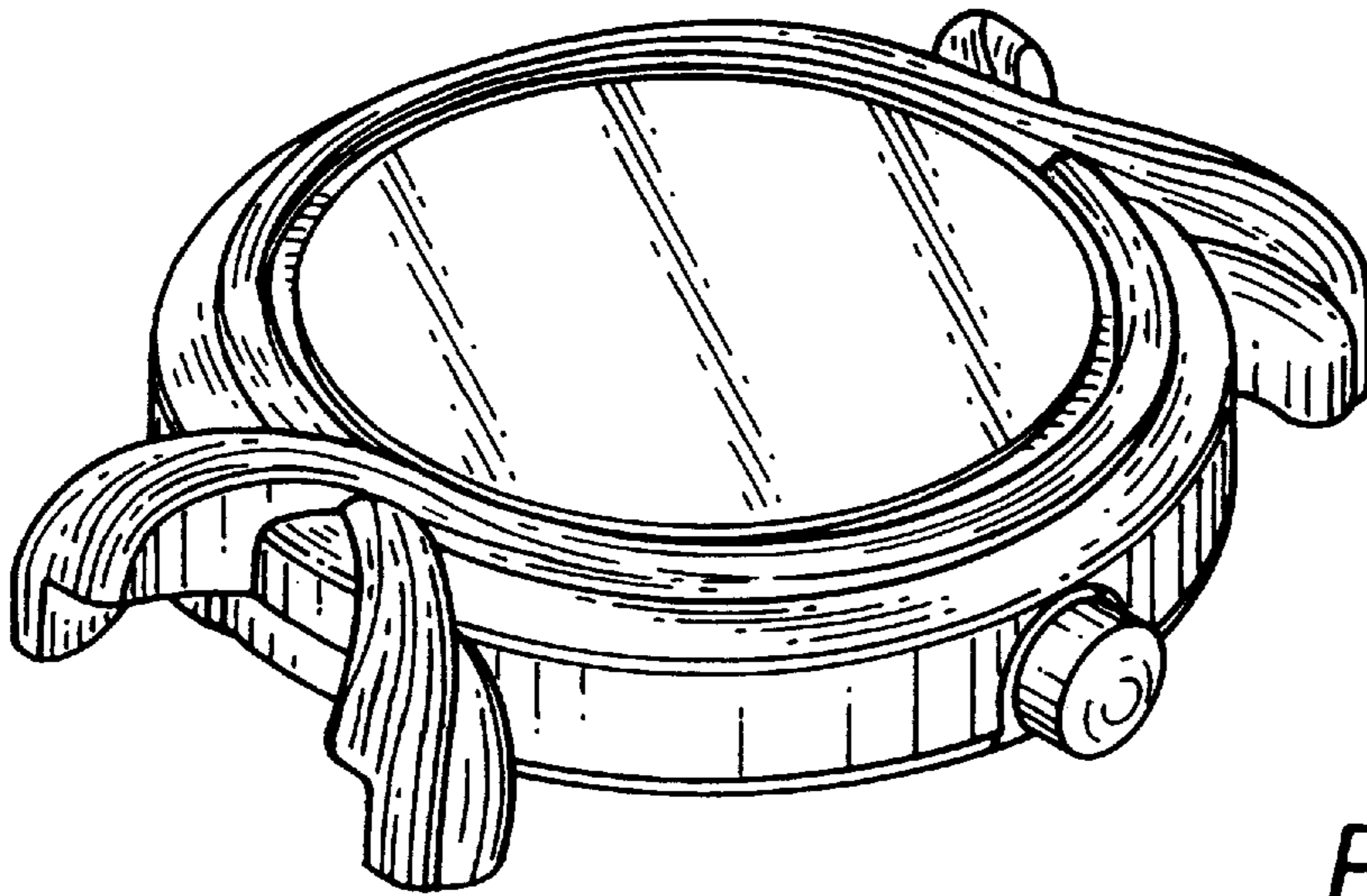

FIG. 1

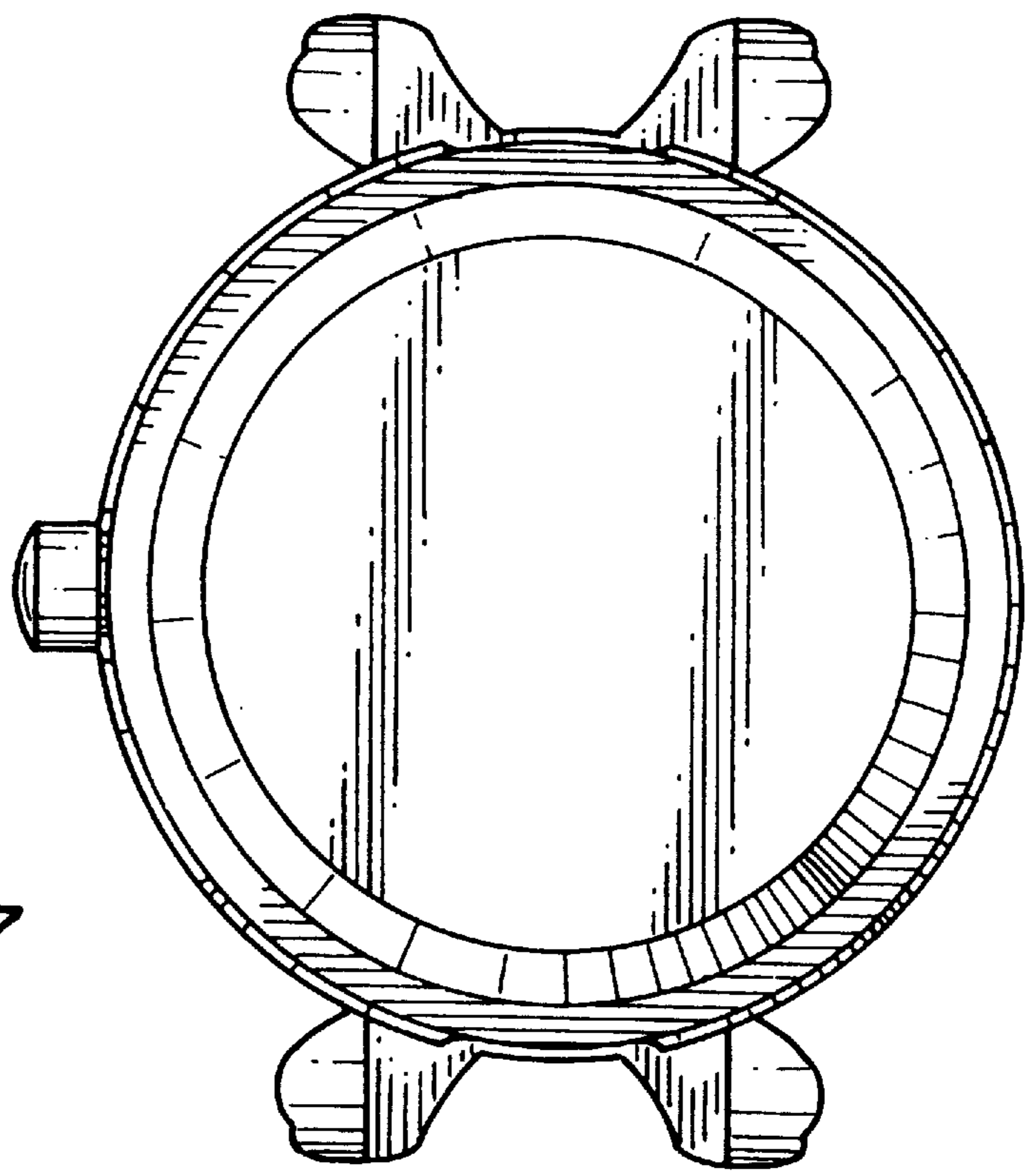

FIG. 7

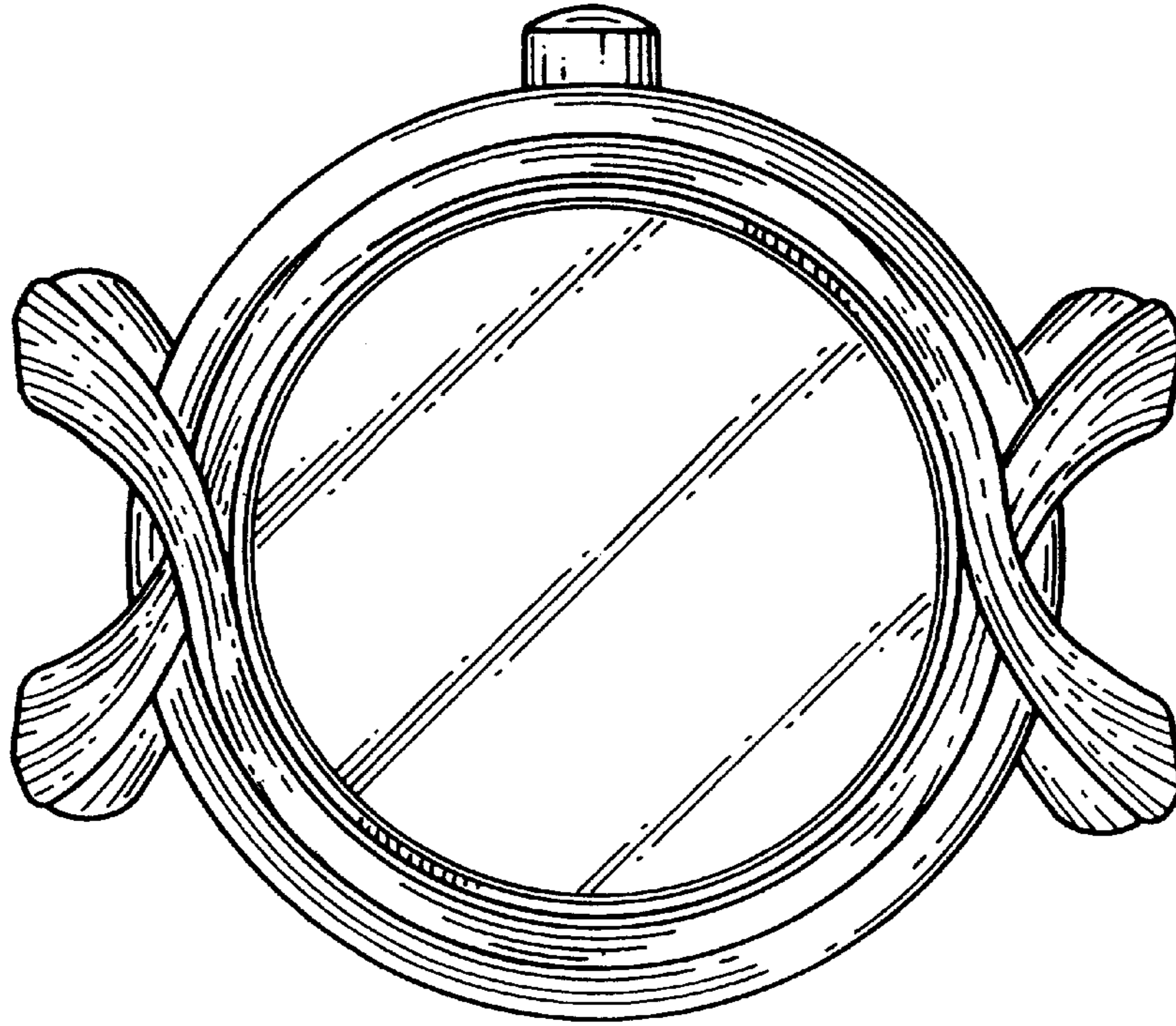

FIG. 3

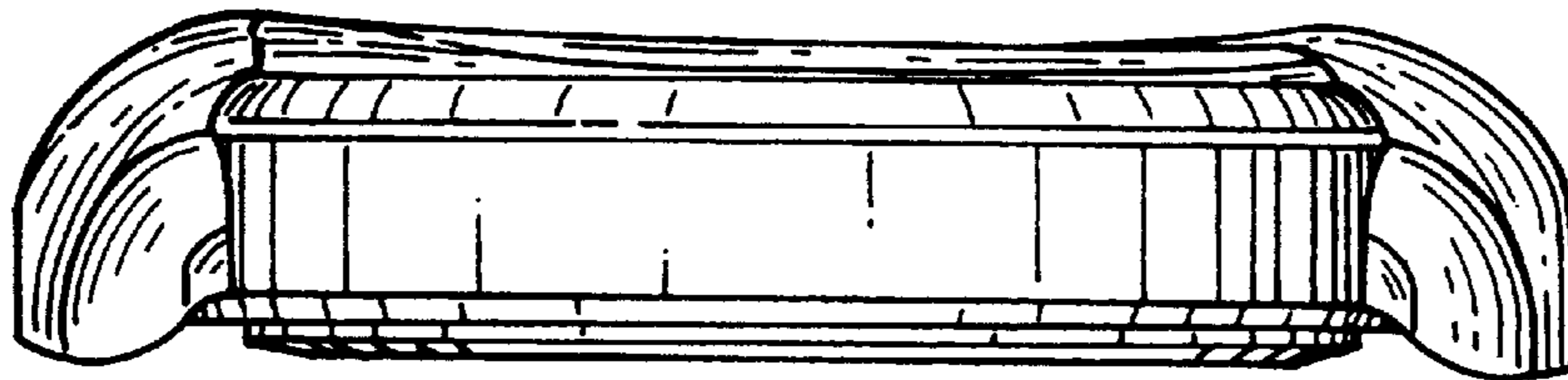

FIG. 2

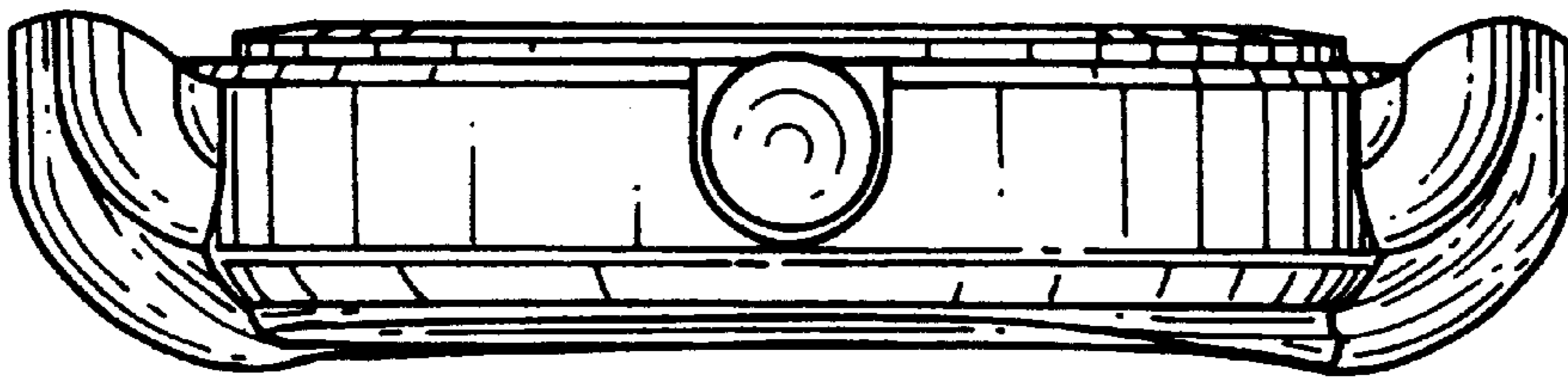

FIG. 4

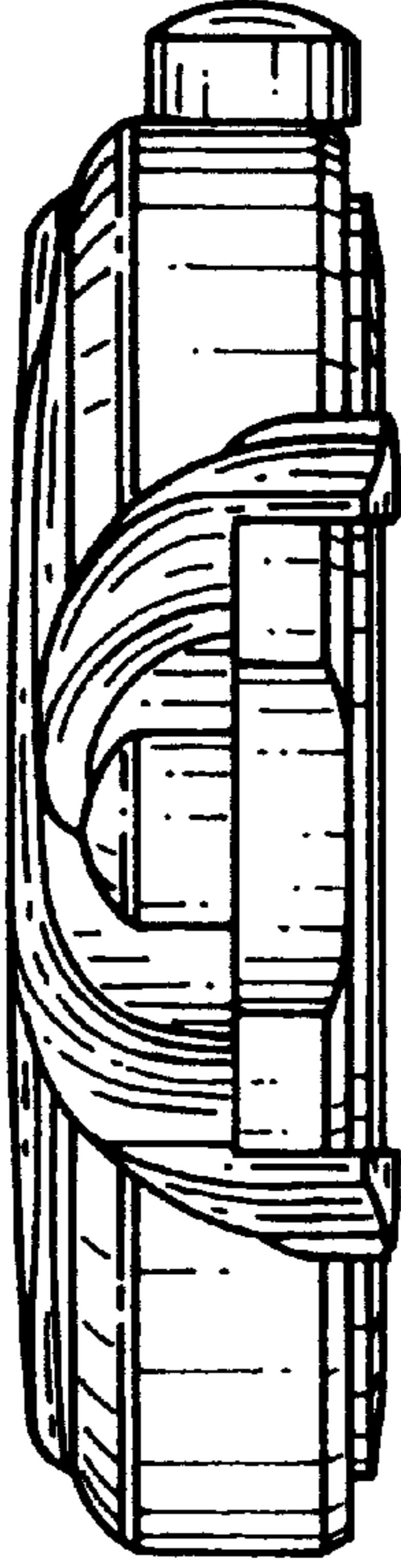

FIG. 5

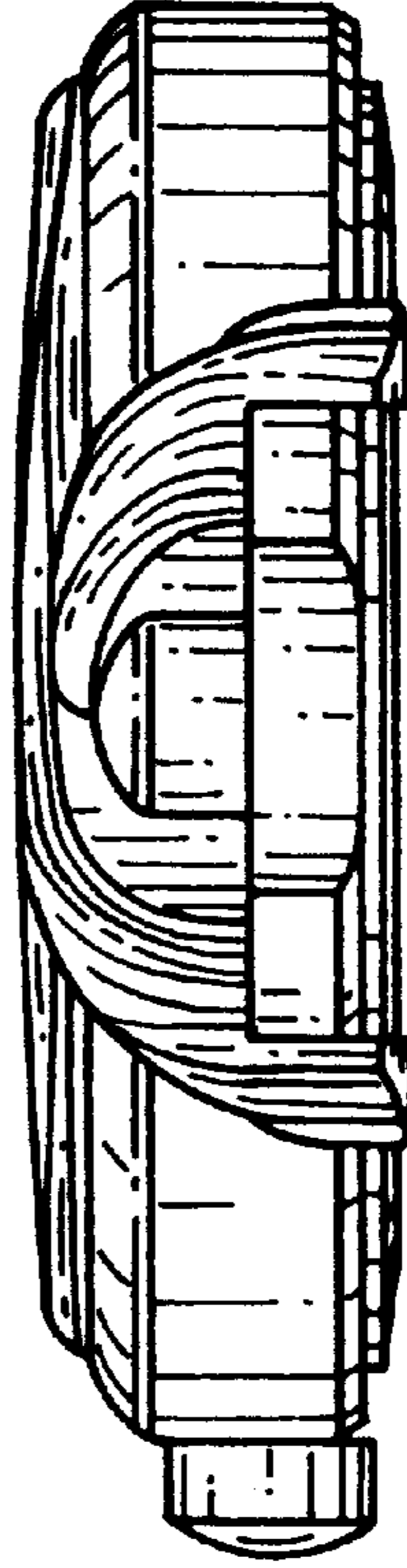

FIG. 6