



US00D456675S

(12) **United States Design Patent**
Jong

(10) **Patent No.:** **US D456,675 S**

(45) **Date of Patent:** **** May 7, 2002**

(54) **LAWN MOWER**

(75) **Inventor:** **Jung-Chang Jong, Chungli (TW)**

(73) **Assignee:** **Jenn Feng Industrial Co., Ltd.,
Taoyuan (TW)**

(**) **Term:** **14 Years**

(21) **Appl. No.:** **29/139,409**

(22) **Filed:** **Mar. 28, 2001**

(51) **LOC (7) Cl.** **08-01**

(52) **U.S. Cl.** **D8/8**

(58) **Field of Search** D8/1, 8, 9; 30/276,
30/DIG. 5; 172/13, 15, 16, 17

(56) **References Cited**

U.S. PATENT DOCUMENTS

5,615,970 A	4/1997	George et al.	
D379,748 S	6/1997	George et al.	8/1
D380,129 S	6/1997	Edward et al.	8/1
5,771,582 A *	6/1998	Tuggle	30/276
D398,817 S	9/1998	Edward et al.	8/5
D414,388 S	9/1999	Stuart et al.	8/5
6,116,349 A *	9/2000	Wilson	30/DIG. 5

D440,131 S	*	4/2001	Aglassinger et al.	D8/8
D446,699 S	*	8/2001	Marshall et al.	D8/8
D450,226 S	*	11/2001	Martin	D8/8

OTHER PUBLICATIONS

Black and Decker catalog 1990–1991; #82310 Bump Feed
Yard Trimmer.*

* cited by examiner

Primary Examiner—Robin V. Taylor

(57) **CLAIM**

The ornamental design for lawn mower, as shown and
described.

DESCRIPTION

FIG. 1 is a perspective view of lawn mower showing my
new design;
FIG. 2 is a front elevational view thereof;
FIG. 3 is a rear elevational view thereof;
FIG. 4 is a left side elevational view thereof;
FIG. 5 is right side elevational view thereof;
FIG. 6 is a top view thereof; and,
FIG. 7 is a bottom view thereof.

1 Claim, 7 Drawing Sheets

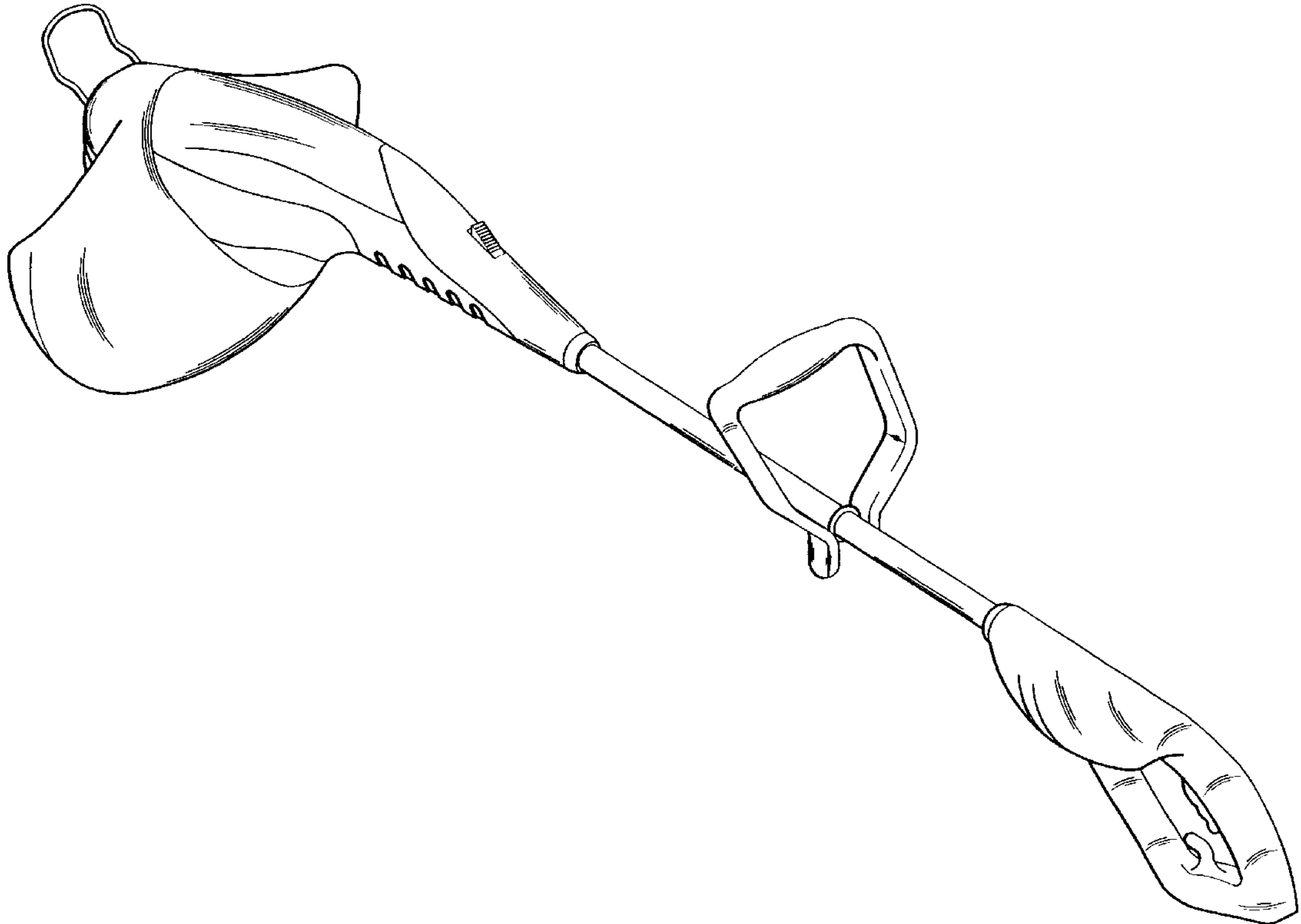

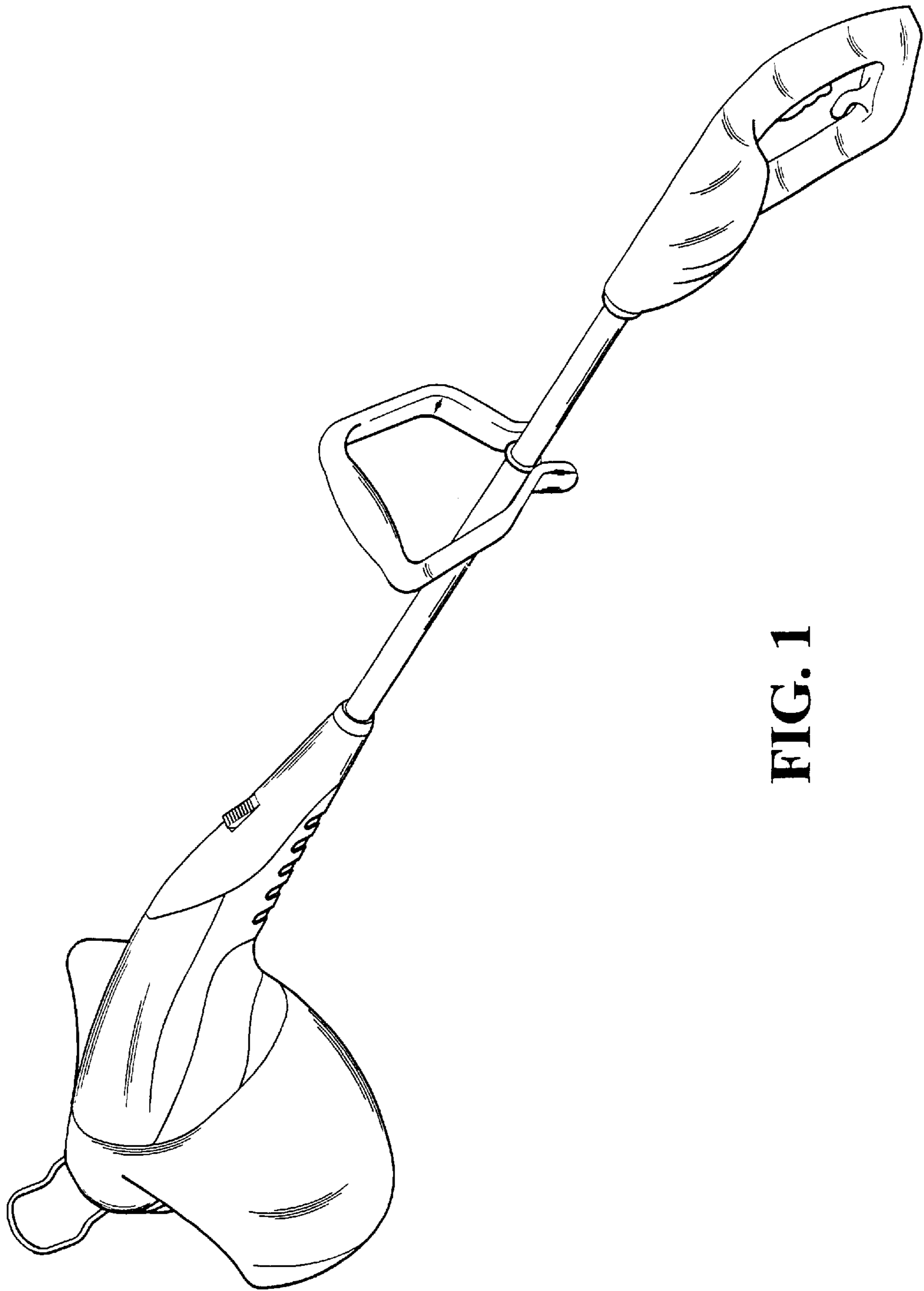

FIG. 1

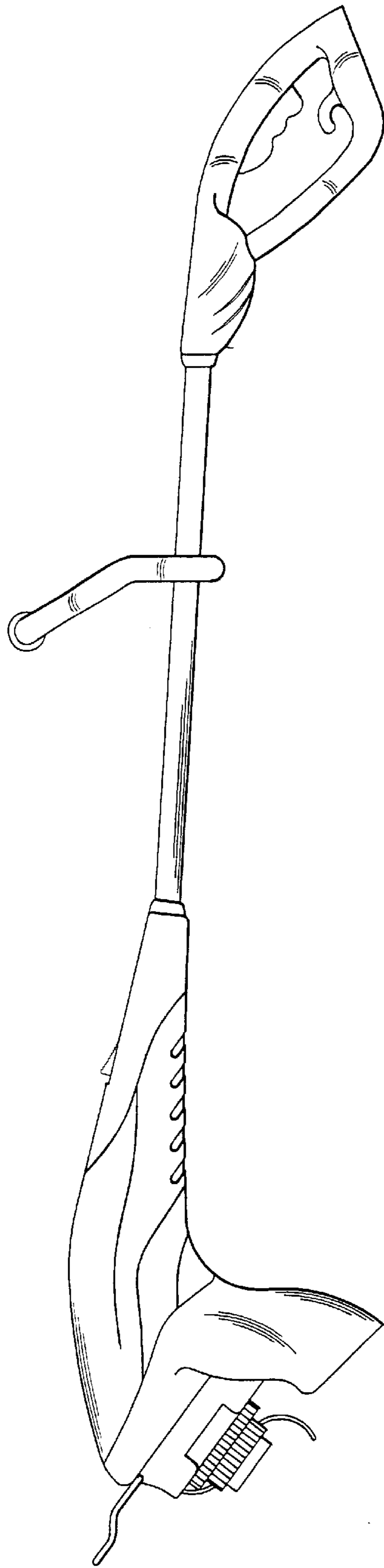

FIG. 2

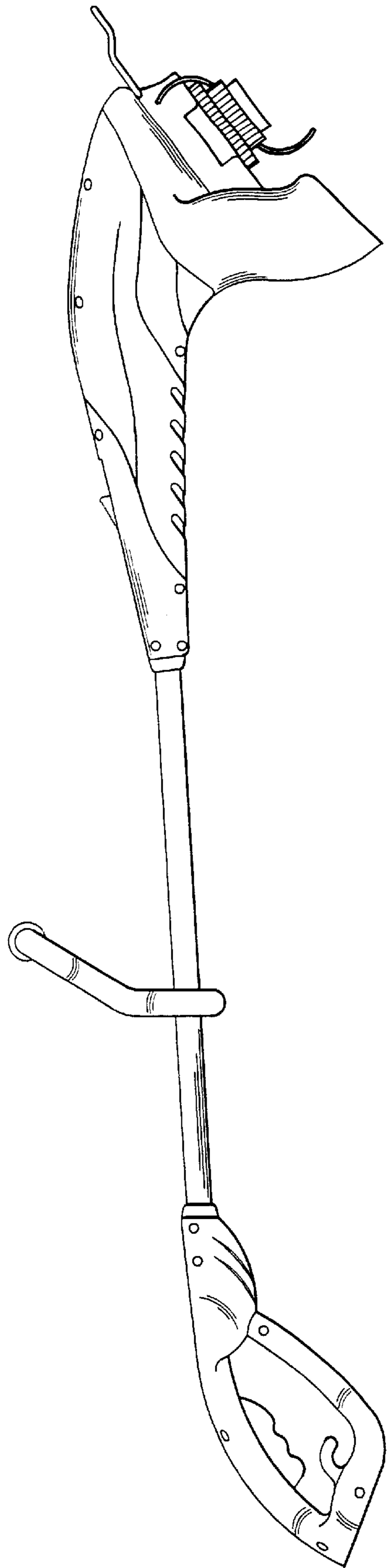

FIG. 3

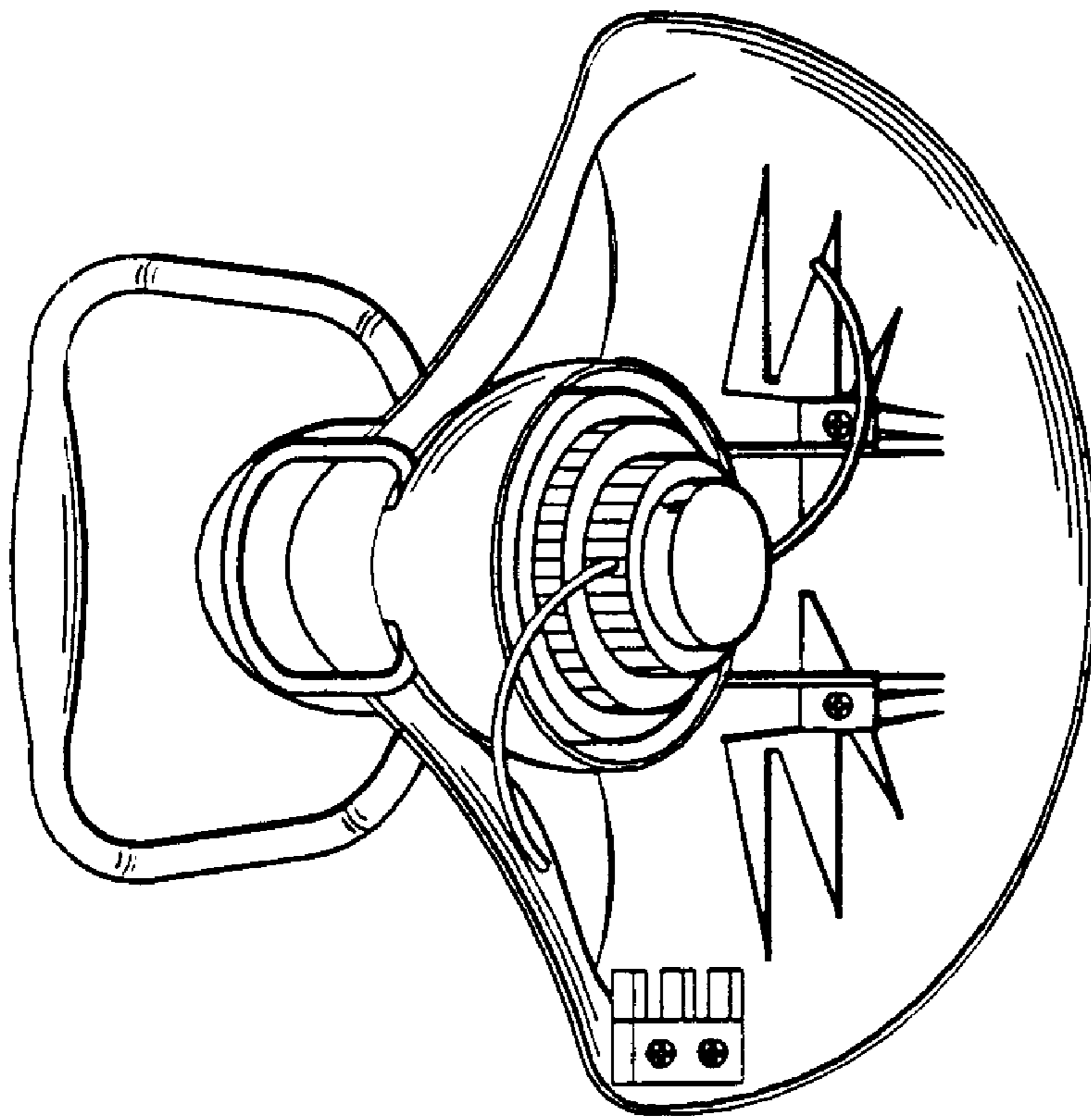

FIG. 4

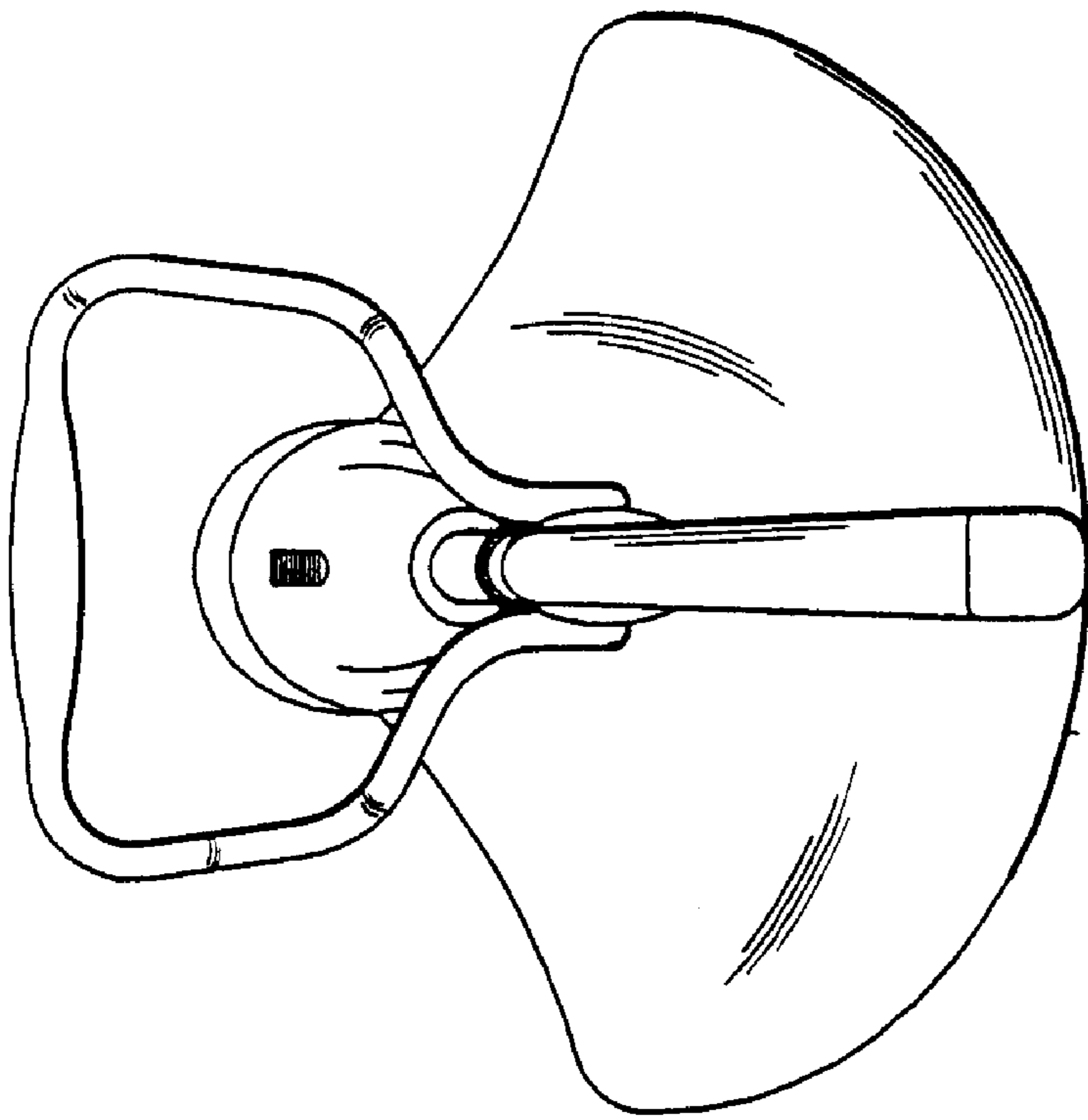

FIG. 5

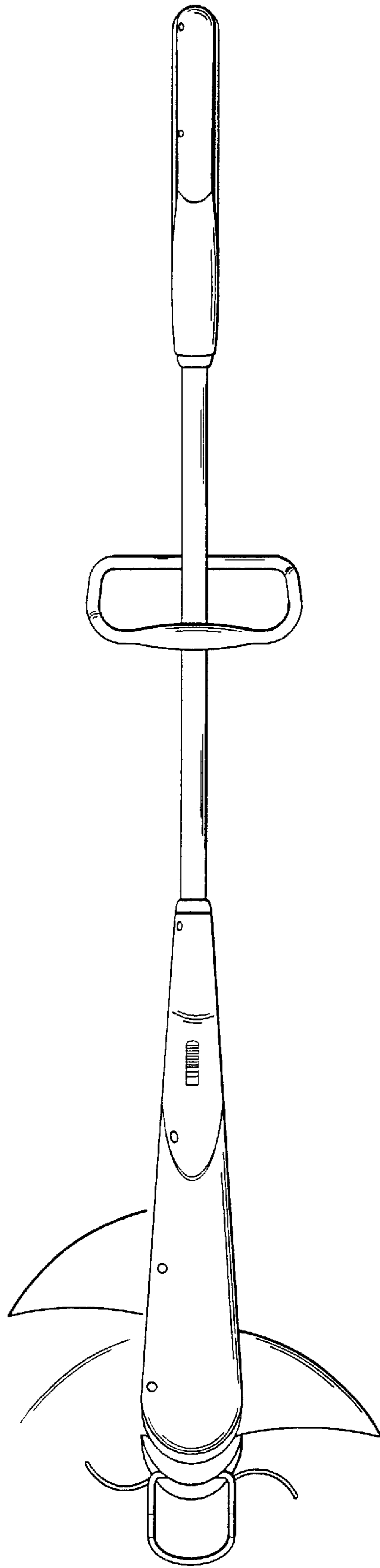

FIG. 6

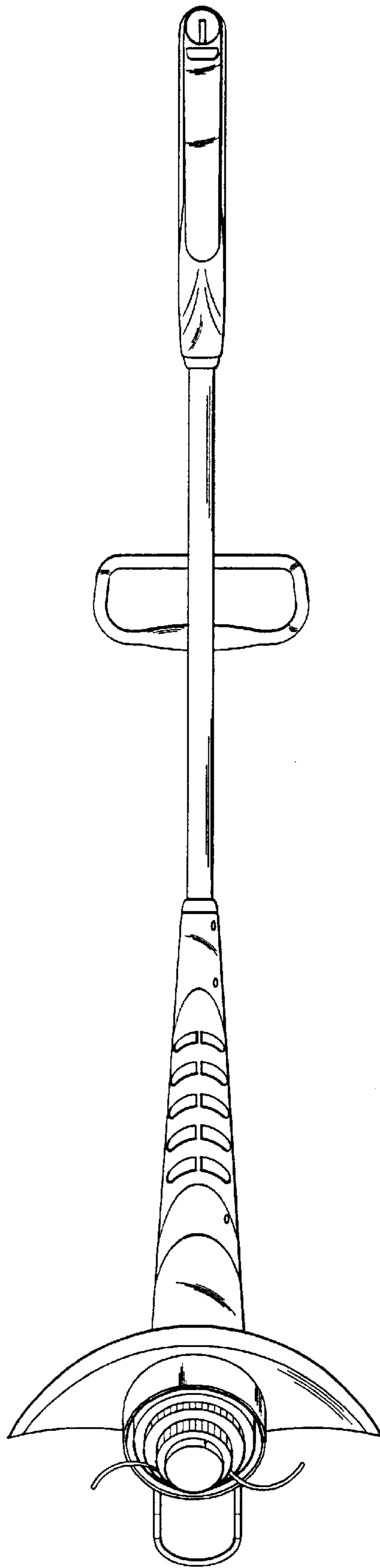

FIG. 7