



US00D456637S

(12) **United States Design Patent**
Overdevest

(10) **Patent No.:** **US D456,637 S**

(45) **Date of Patent:** **** May 7, 2002**

(54) **DISPLAY BENCH**

(75) **Inventor:** **Edward J. Overdevest**, Upper Deerfield Township, NJ (US)

(73) **Assignee:** **Overdevest Nurseries, L.P.**, Bridgeton, NJ (US)

(**) **Term:** **14 Years**

(21) **Appl. No.:** **29/144,651**

(22) **Filed:** **Jun. 28, 2001**

(51) **LOC (7) Cl.** **06-04**

(52) **U.S. Cl.** **D6/458; D6/479**

(58) **Field of Search** D6/343, 397, 409-415, D6/458, 462-468, 477, 479, 475, 455, 456, 487, 546, 559, 561, 566, 567, 569, 573, 574; 108/50.11, 59, 91, 92, 93, 157.1, 157.17, 158.1; 211/13.1, 37, 38, 85.31, 85.4, 30, 34, 42, 49.1, 90.03, 106, 119, 134, 186-189, 181.1, 200, 204-208; 248/441.1, 465.1, 175, 451, 124.1, 448

(56) **References Cited**

U.S. PATENT DOCUMENTS

- 1,631,725 A * 6/1927 Halvorsen 211/85.31
- D221,667 S * 8/1971 Smith et al. D6/410
- 4,005,548 A * 2/1977 Nahon 211/189 X
- D285,885 S * 9/1986 Cusenza et al. D6/512
- 4,946,050 A * 8/1990 Akopiantz 211/182

- D314,097 S * 1/1991 Buist D6/458
- D323,255 S * 1/1992 Titus D6/458
- 5,323,559 A * 6/1994 Allman D6/458 X
- D423,809 S * 5/2000 Lund et al. D6/396
- 6,237,882 B1 * 5/2001 DiMuzio 248/175

* cited by examiner

Primary Examiner—Cathron C. Brooks

(74) *Attorney, Agent, or Firm*—Norman E. Lehrer

(57) **CLAIM**

The ornamental design for a “display bench”, as shown and described.

DESCRIPTION

FIG. 1 is a perspective view of a “display bench” showing my new design;

FIG. 2 is a front elevational view thereof, the rear elevational view being identical thereto;

FIG. 3 is a top plan view thereof;

FIG. 4 is a bottom plan view thereof;

FIG. 5 is a left side elevational view thereof, the right side being identical thereto; and,

FIG. 6 is a perspective view similar to FIG. 1 showing the “display bench” in use supporting horizontal surfaces.

The broken line showing of the horizontal surfaces is for environmental purposes only and forms no part of the claimed design.

1 Claim, 3 Drawing Sheets

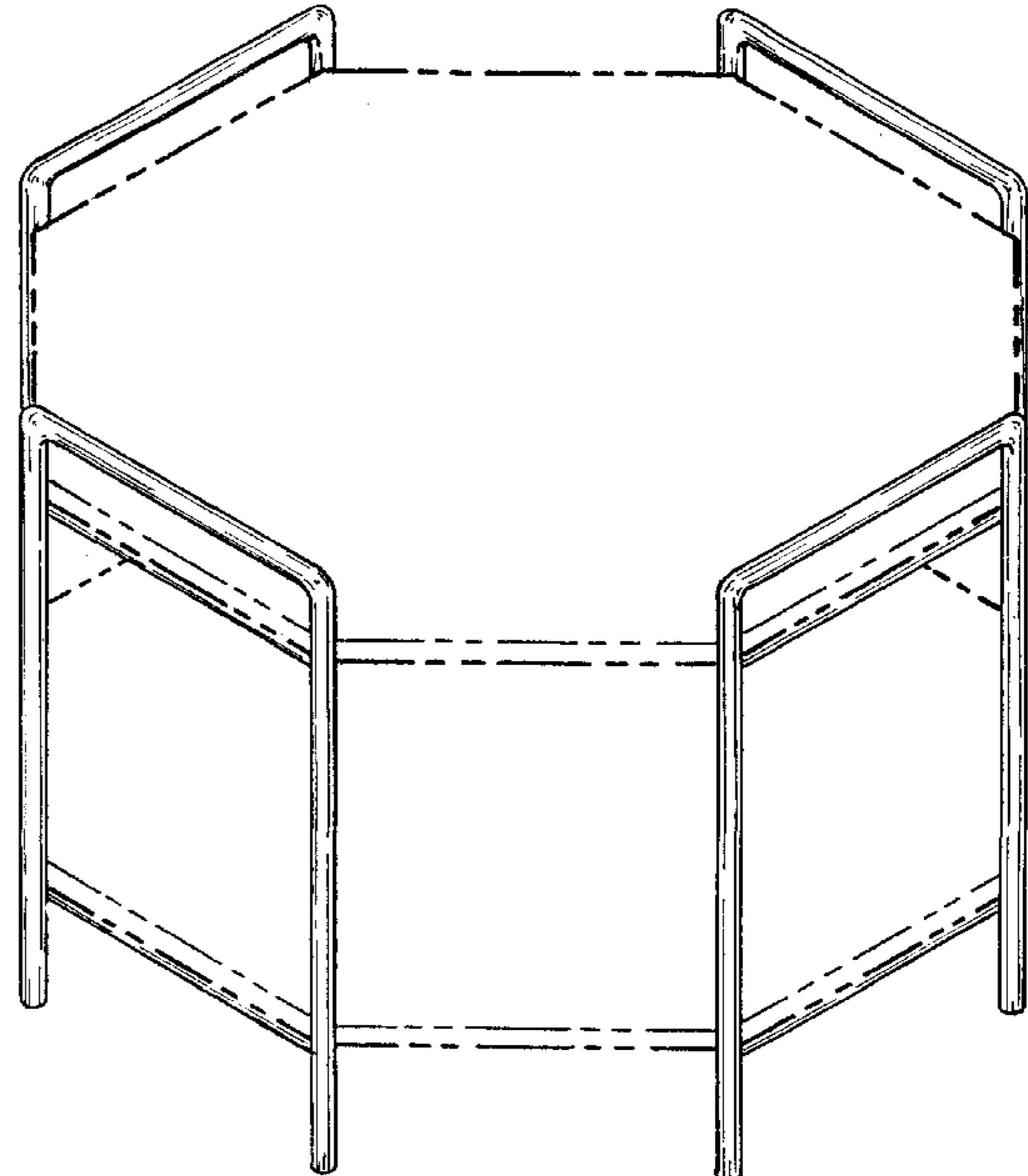
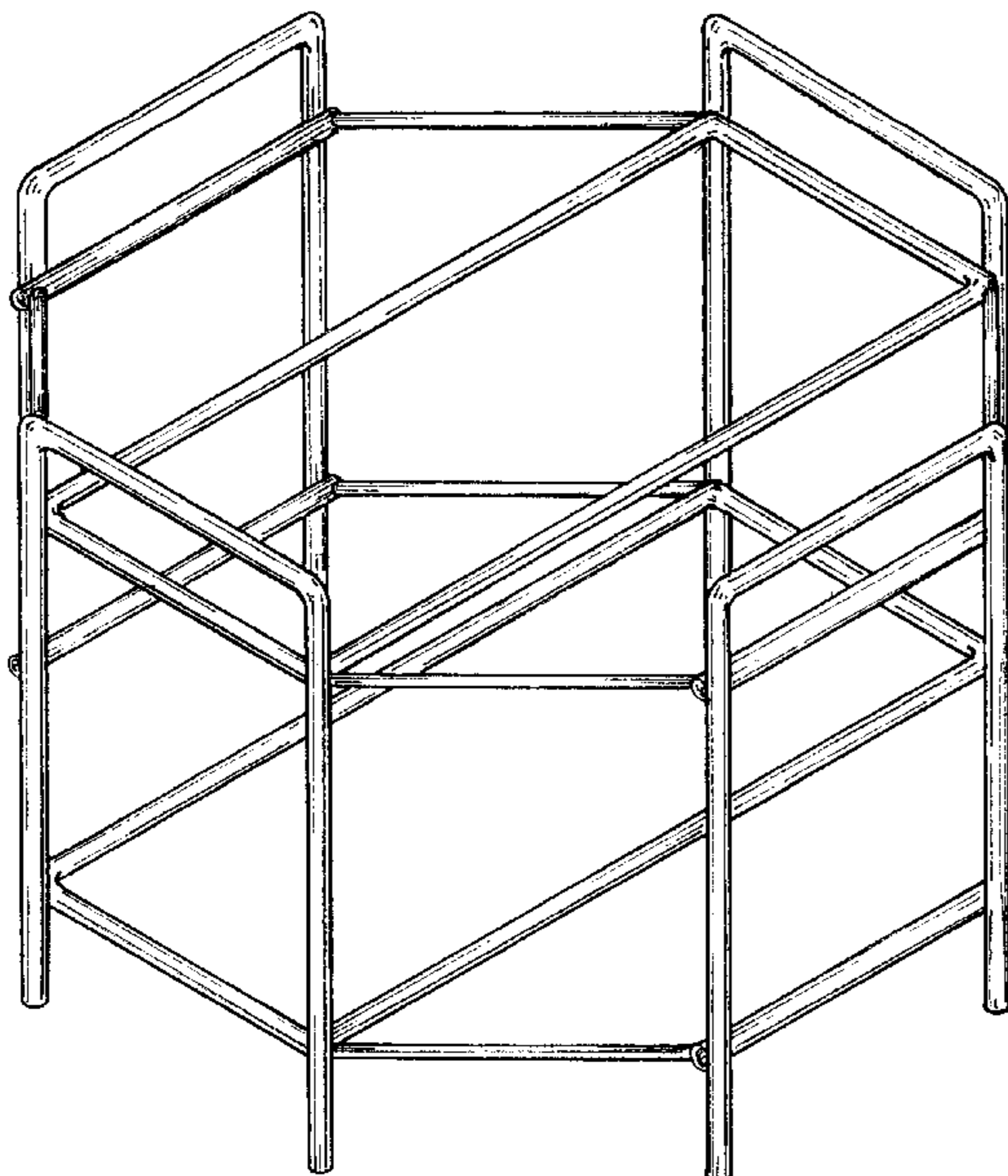

Fig. 1

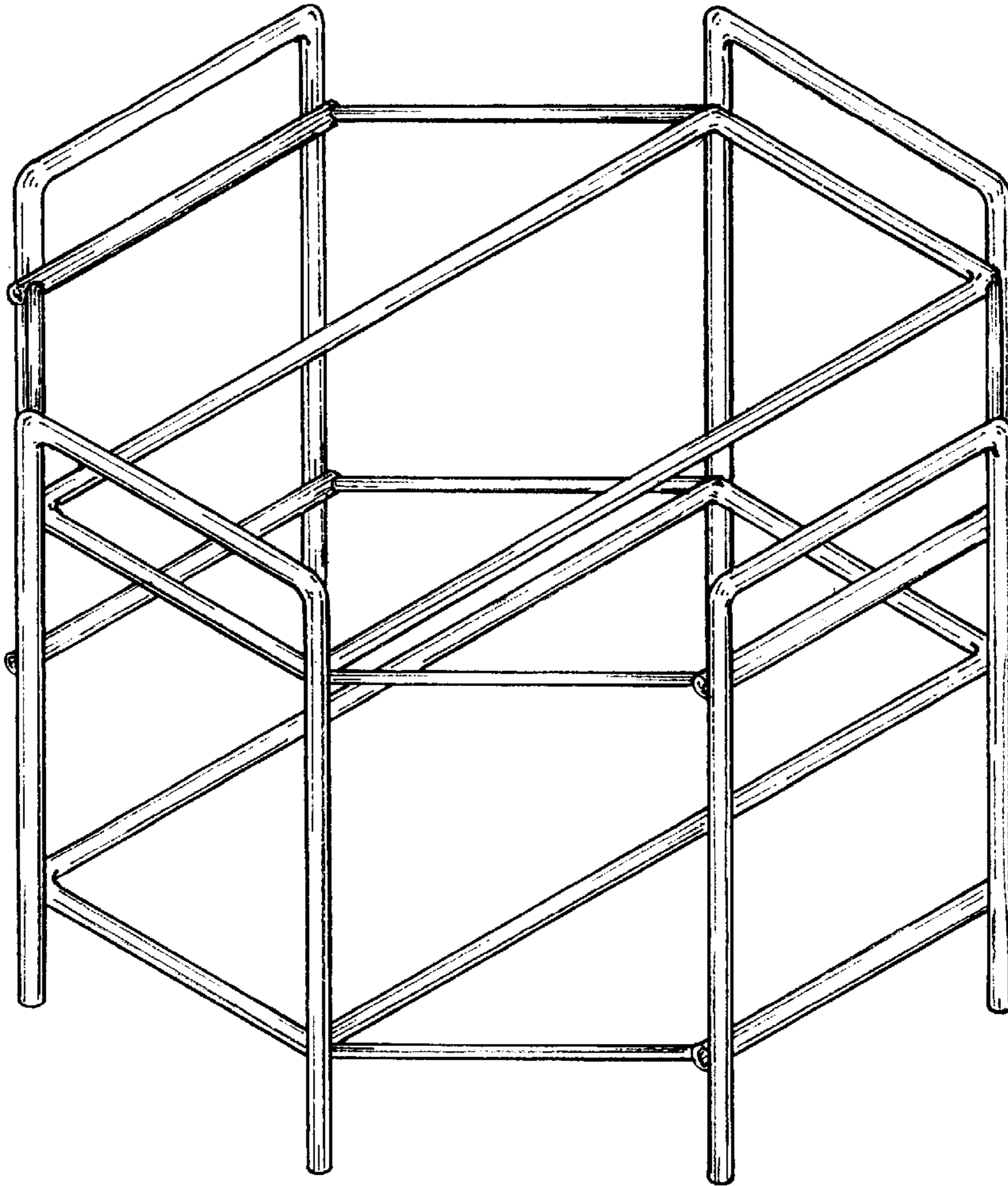

Fig. 2

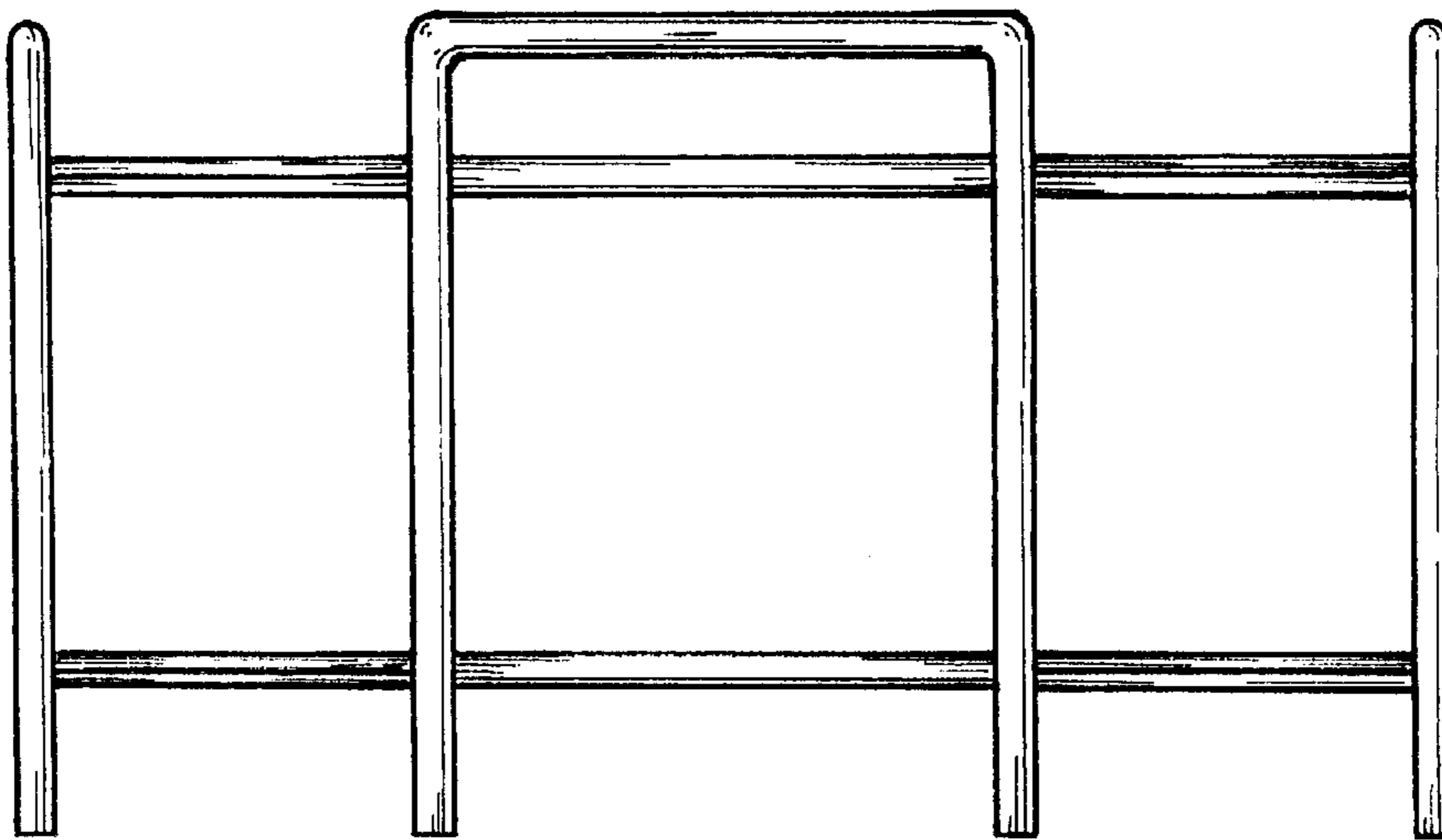

Fig. 3

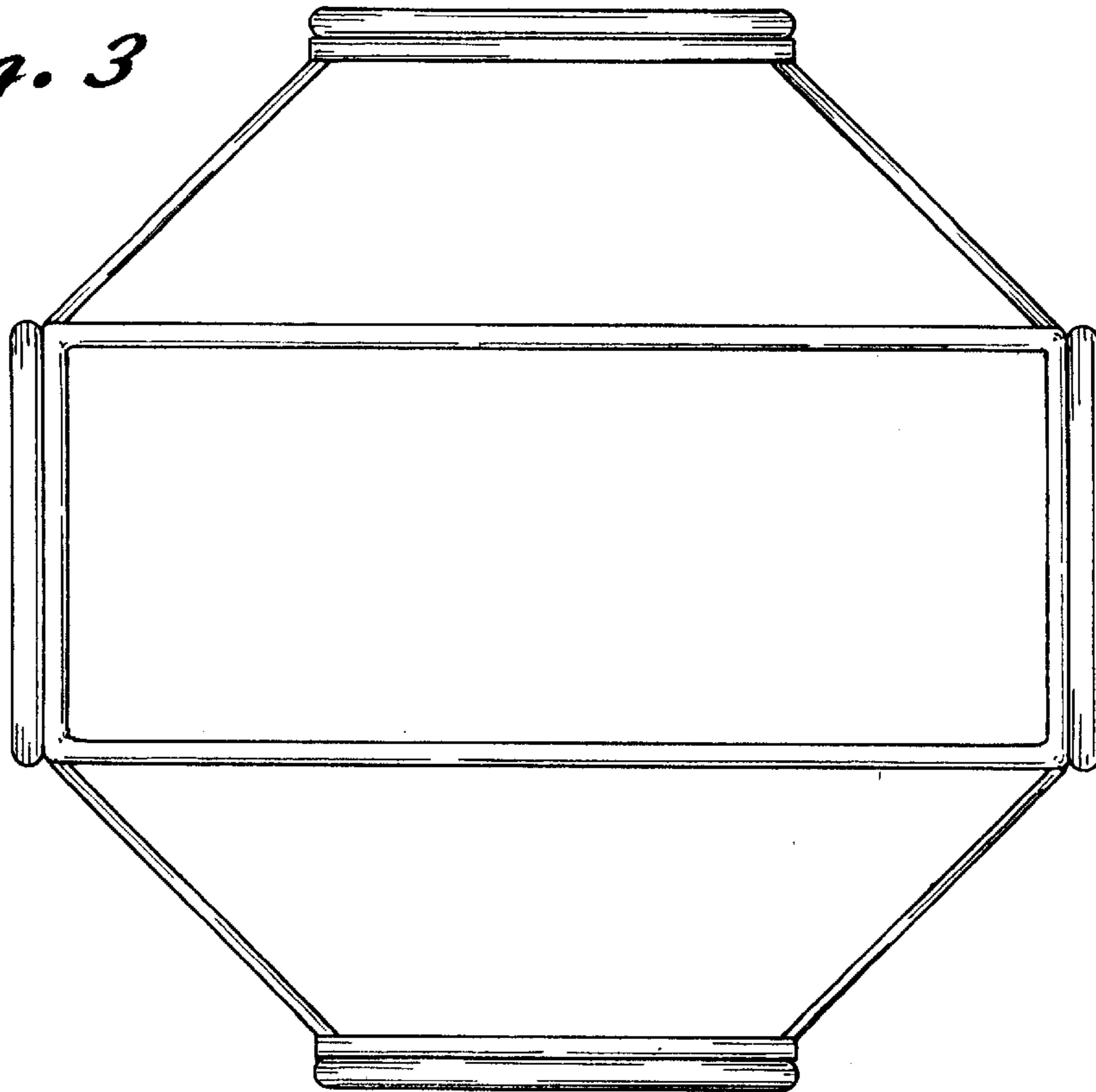

Fig. 4

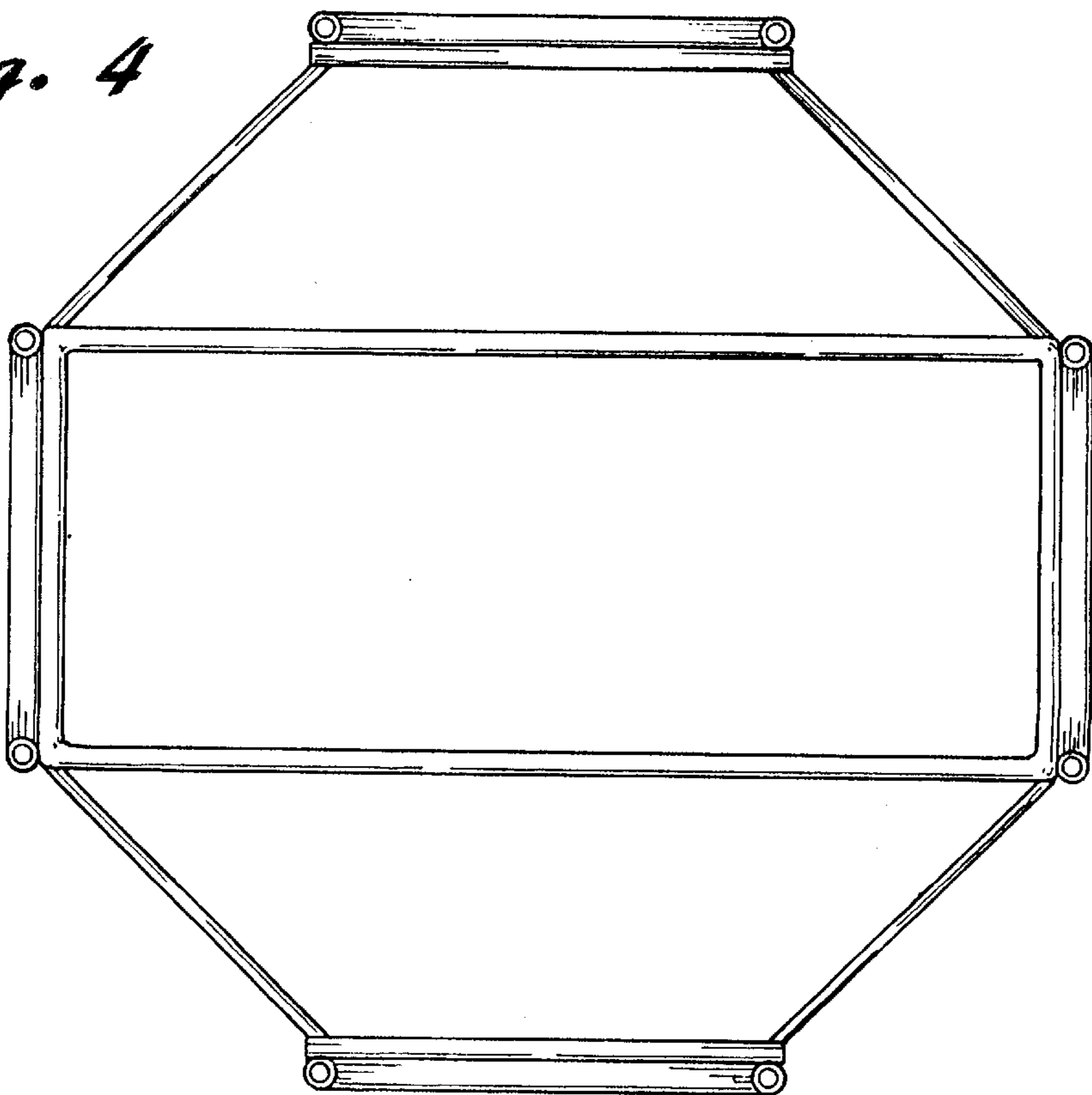

Fig. 5

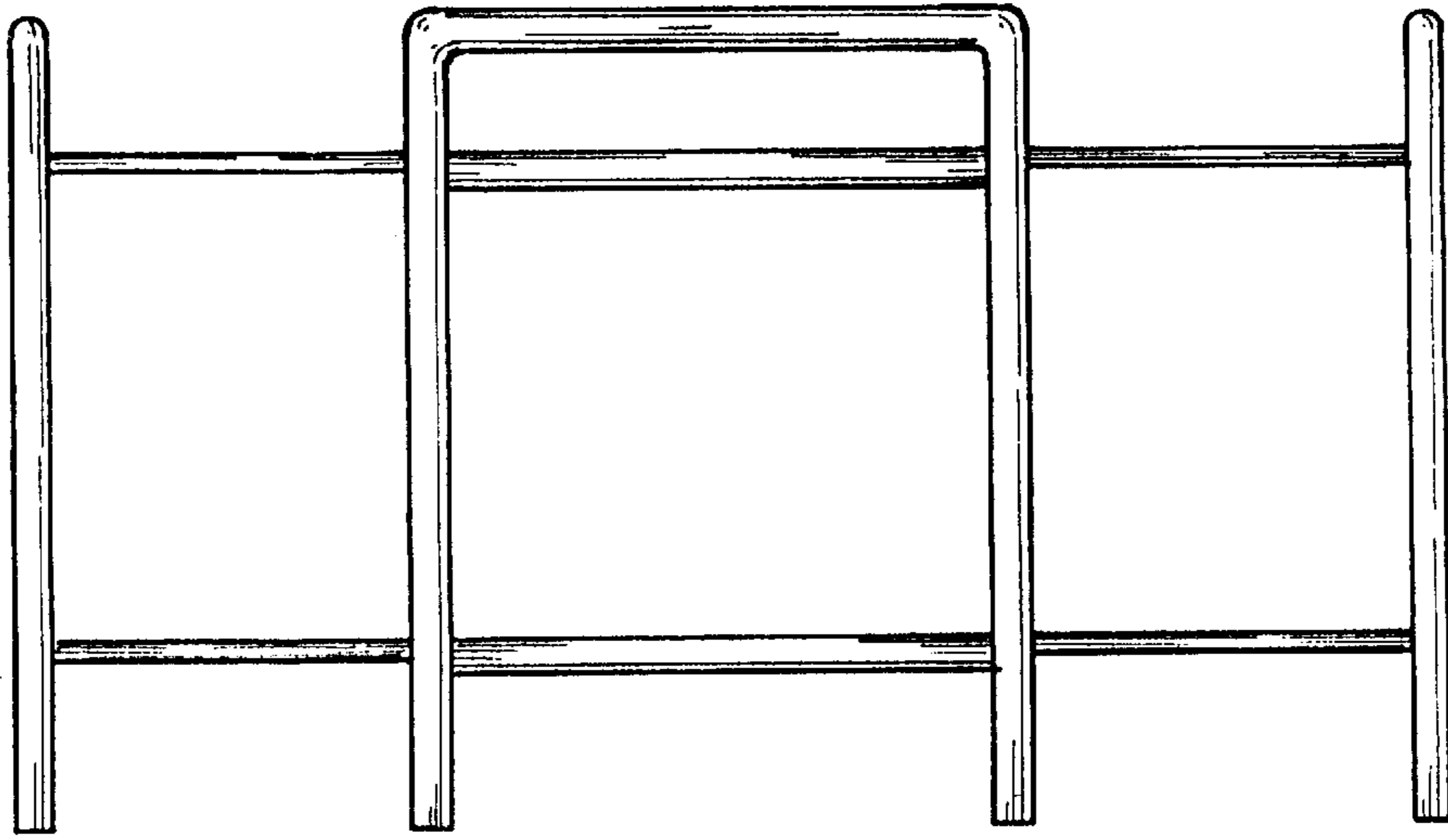

Fig. 6

