



US00D456569S

(12) **United States Design Patent**
Northrop

(10) **Patent No.:** **US D456,569 S**

(45) **Date of Patent:** **** Apr. 30, 2002**

(54) **CONTINUOUS PET WATERING DEVICE**

5,845,600 A * 12/1998 Mendes 119/51.5
D432,279 S * 10/2000 Kim D30/121

(75) **Inventor:** **Melaney Northrop**, Cleburne, TX (US)

* cited by examiner

(73) **Assignee:** **Doskocil Manufacturing Company, Inc.**, Arlington, TX (US)

Primary Examiner—Pamela J. Burgess

(74) *Attorney, Agent, or Firm*—Locke Liddell & Sapp LLP

(**) **Term:** **14 Years**

(57) **CLAIM**

(21) **Appl. No.:** **29/142,924**

The ornamental design for continuous pet watering device, as shown and described.

(22) **Filed:** **Jun. 5, 2001**

DESCRIPTION

(51) **LOC (7) Cl.** **30-03**

(52) **U.S. Cl.** **D30/132**

(58) **Field of Search** D30/121, 122,
D30/128, 129, 132, 133, 124; 119/41, 77,
61, 52.1, 51.5, 72, 74, 53, 54, 51.14, 72.5,
51.01

FIG. 1 is a front perspective view of the continuous pet watering device, showing our design;
FIG. 2 is a top plan view thereof;
FIG. 3 is a front elevation view thereof;
FIG. 4 is a left side elevation view thereof;
FIG. 5 is a rear elevation view thereof;
FIG. 6 is a right side elevation view thereof; and,
FIG. 7 is a bottom plan view thereof.

(56) **References Cited**

U.S. PATENT DOCUMENTS

4,721,063 A * 1/1988 Atchley 119/52.1

1 Claim, 3 Drawing Sheets

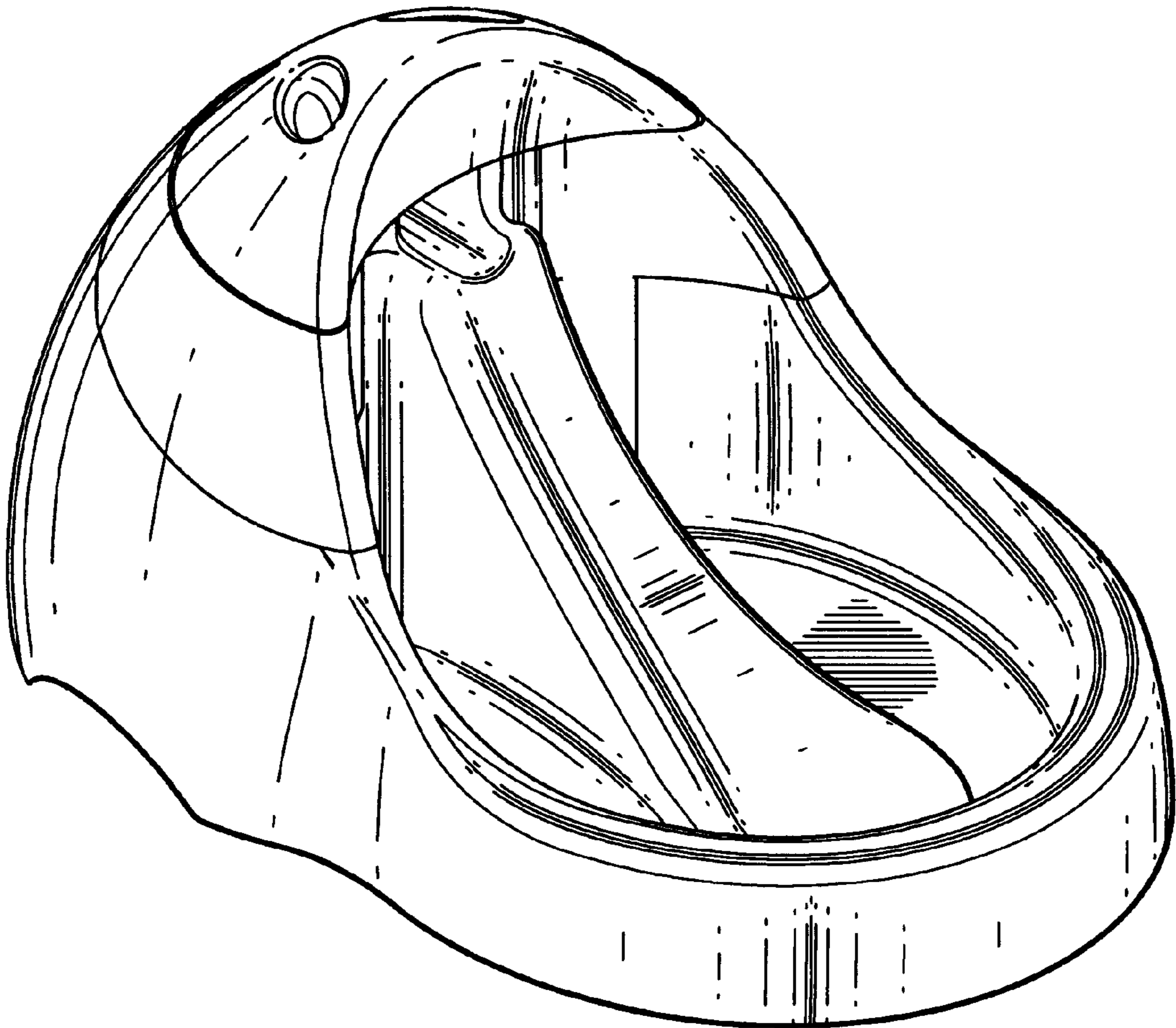

FIG. 1

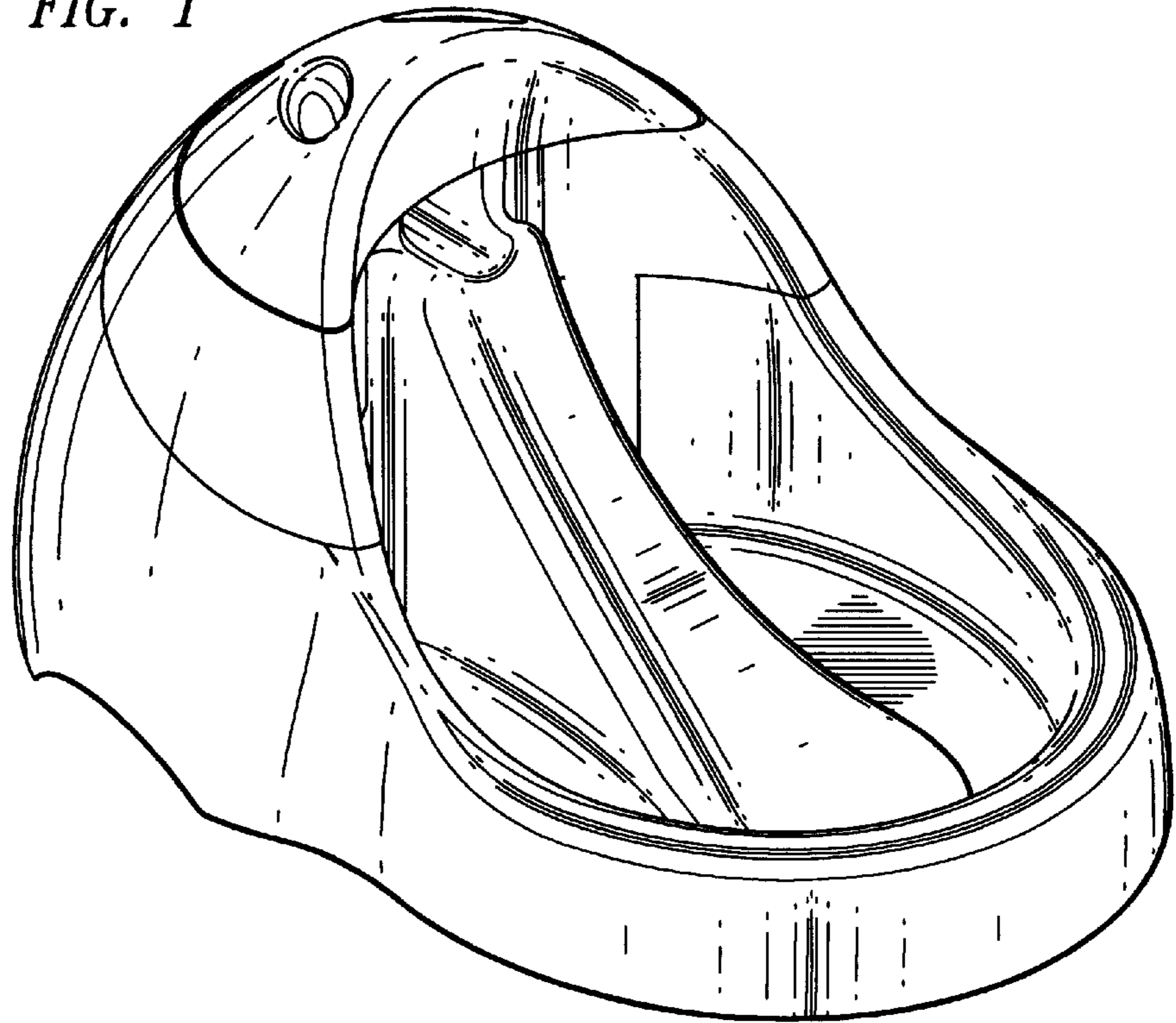

FIG. 2

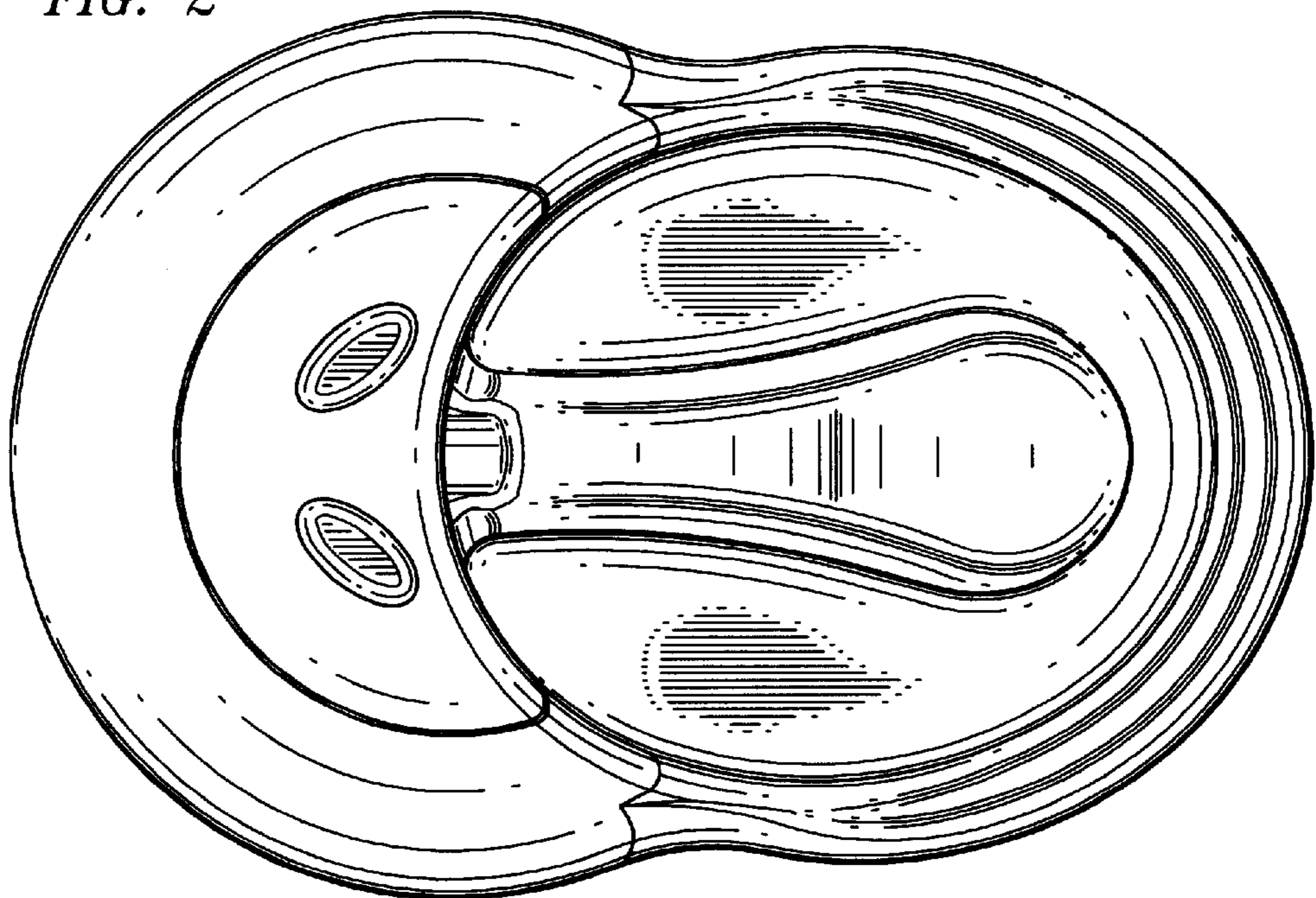

FIG. 3

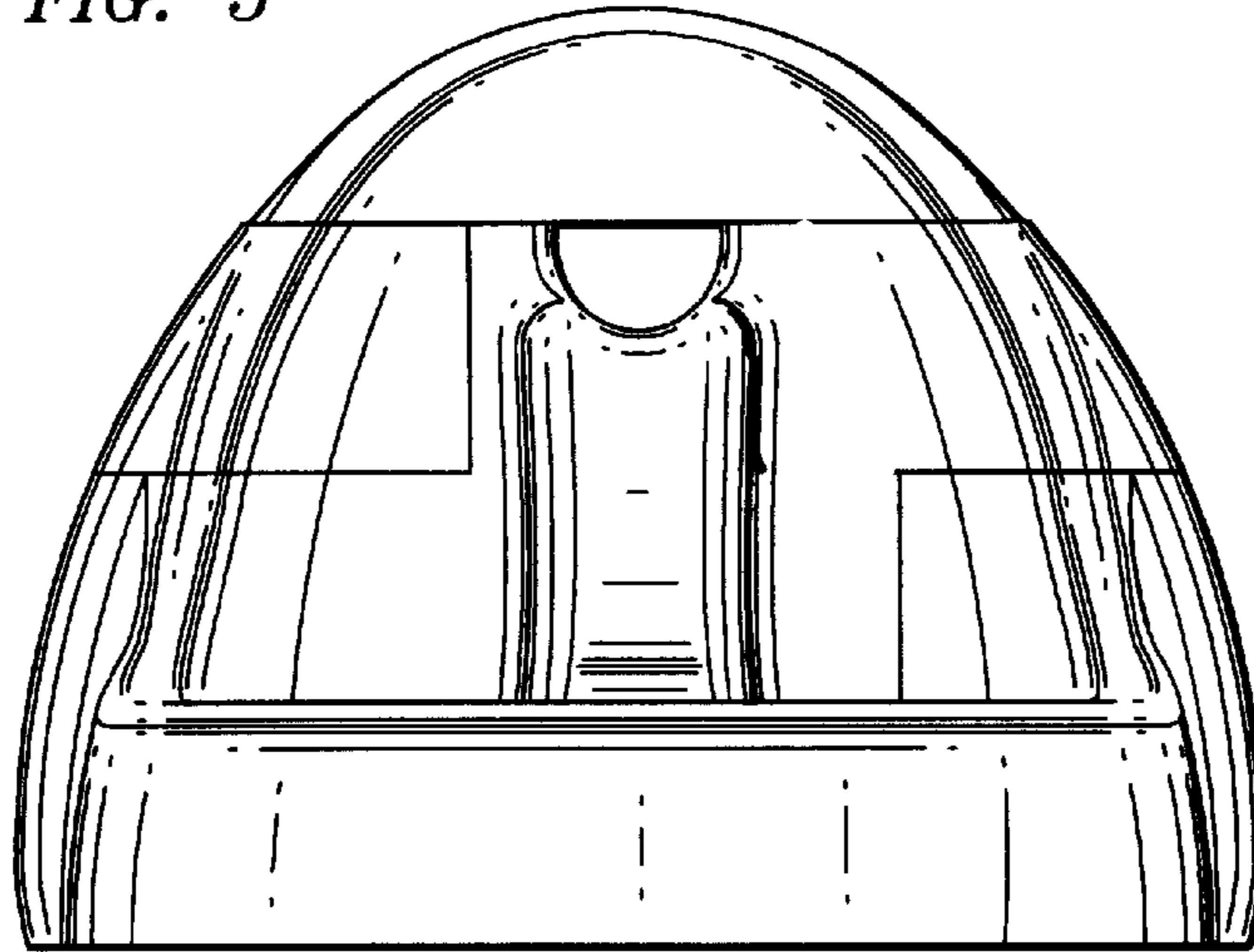

FIG. 4

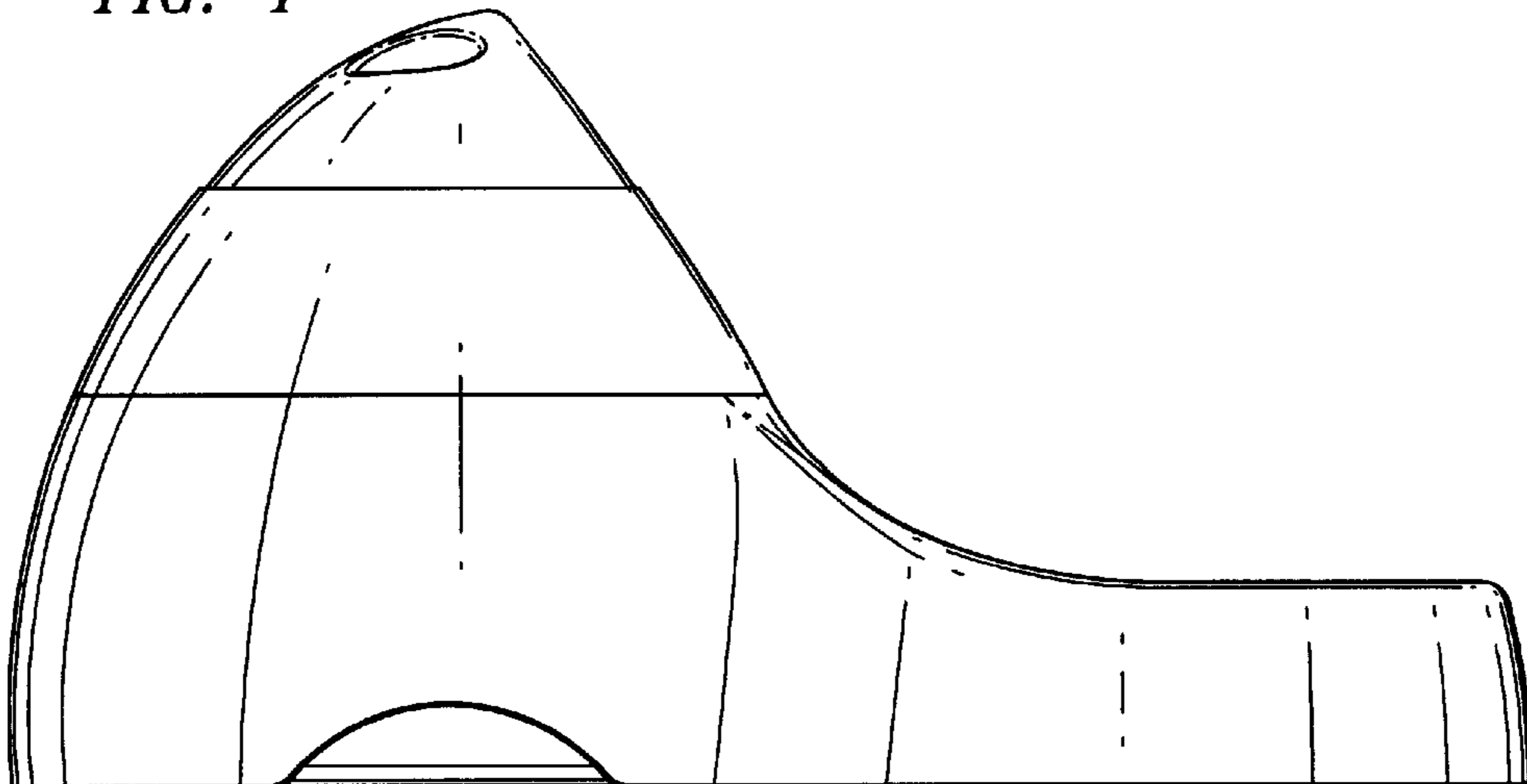

FIG. 5

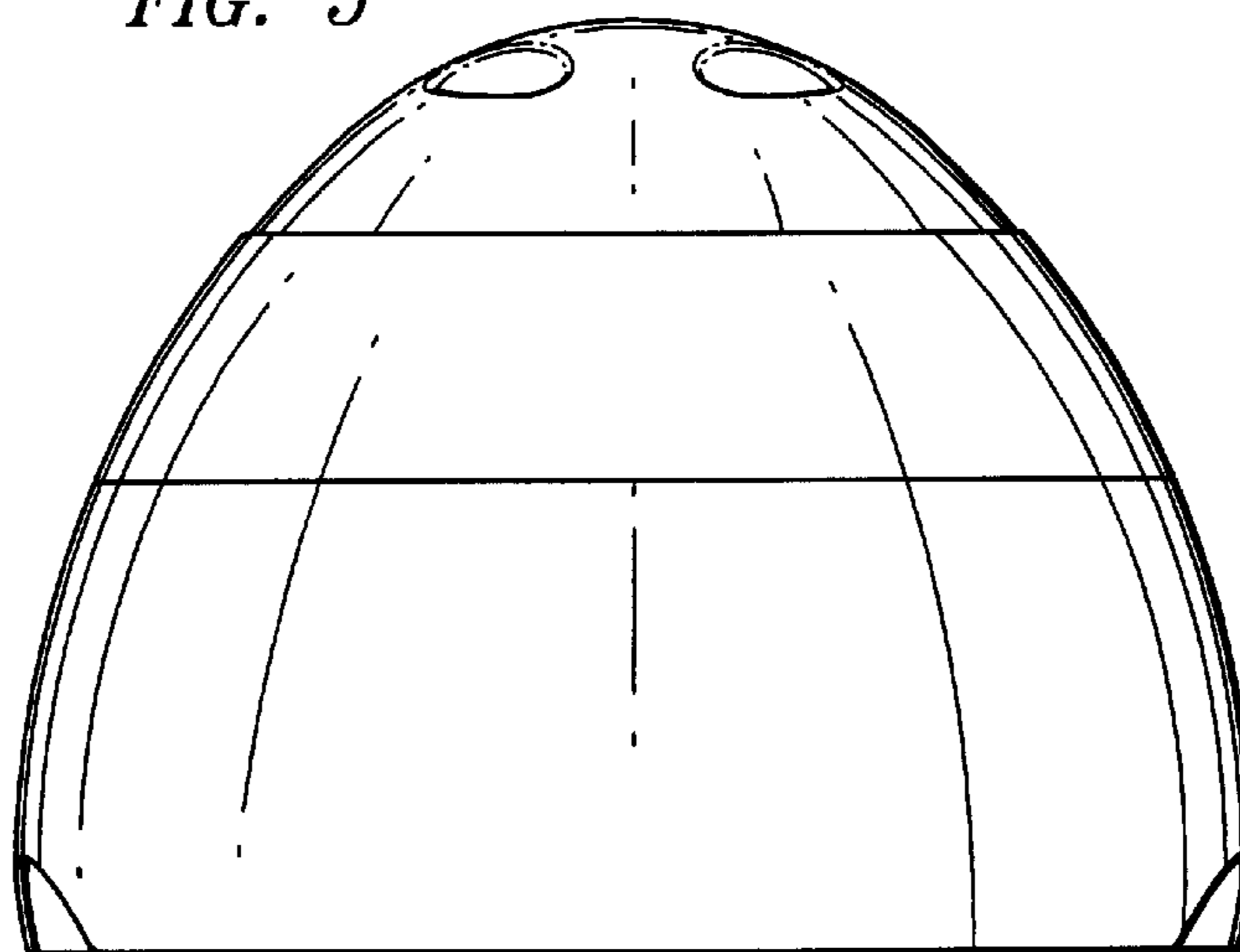

FIG. 6

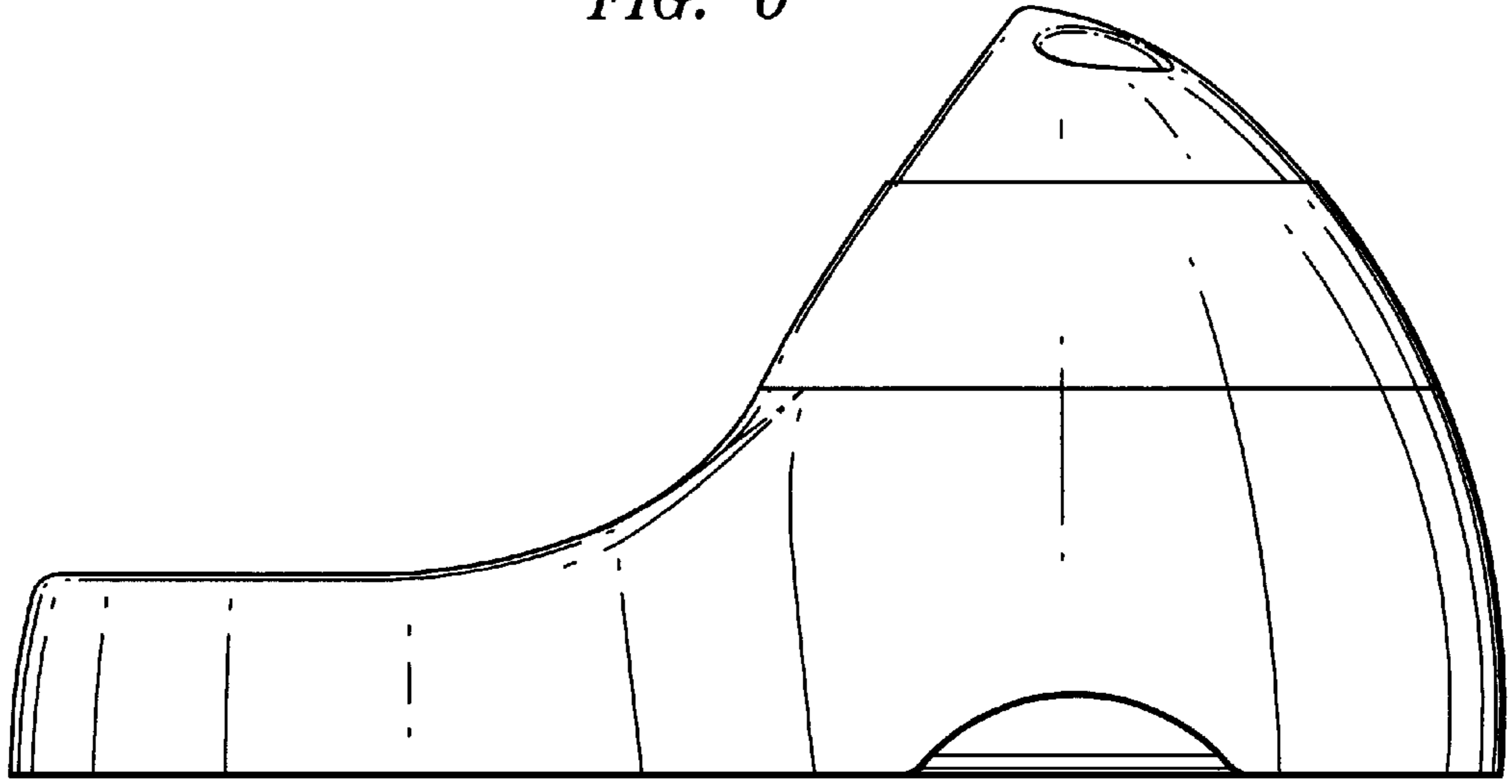

FIG. 7

