



US00D456564S

(12) **United States Design Patent**
Ullmann

(10) **Patent No.:** **US D456,564 S**

(45) **Date of Patent:** **** Apr. 30, 2002**

(54) **SHAVER**

(75) Inventor: **Roland Ullmann**, Offenbach (DE)

(73) Assignee: **Braun GmbH** (DE)

(**) Term: **14 Years**

(21) Appl. No.: **29/138,285**

(22) Filed: **Mar. 9, 2001**

(30) **Foreign Application Priority Data**

Sep. 11, 2000 (XH) DMA/005 017

(51) **LOC (7) Cl.** **28-03**

(52) **U.S. Cl.** **D28/49**

(58) **Field of Search** D28/44.1, 49-53;
30/34.05, 34.1, 34.2, 42, 43, 43.1-43.9,
43.91, 43.92

(56) **References Cited**

U.S. PATENT DOCUMENTS

- D337,857 S * 7/1993 Nakashima et al. D28/49
- D367,946 S * 3/1996 Akashi et al. D28/51
- 5,701,673 A * 12/1997 Ullmann et al. 30/34.1

- D391,022 S * 2/1998 Ullman D28/49
- D405,230 S * 2/1999 Akashi et al. D28/49
- D421,667 S * 3/2000 Ullmann D28/51
- D425,252 S * 5/2000 Ullmann D28/49
- D429,376 S * 8/2000 Nagano et al. D28/49
- D437,973 S * 2/2001 Cockerville D28/50

* cited by examiner

Primary Examiner—Ted Shooman

Assistant Examiner—C. Tuttle

(74) *Attorney, Agent, or Firm*—Fish & Richardson P.C.

(57) **CLAIM**

The ornamental design for a shaver, as shown and described.

DESCRIPTION

FIG. 1 is a perspective view of a shaver from above, showing my design;
 FIG. 2 is a front view thereof;
 FIG. 3 is a right-side view thereof;
 FIG. 4 is a rear view thereof;
 FIG. 5 is a left-side view thereof;
 FIG. 6 is a top plan view thereof; and,
 FIG. 7 is a bottom plan view thereof.

1 Claim, 4 Drawing Sheets

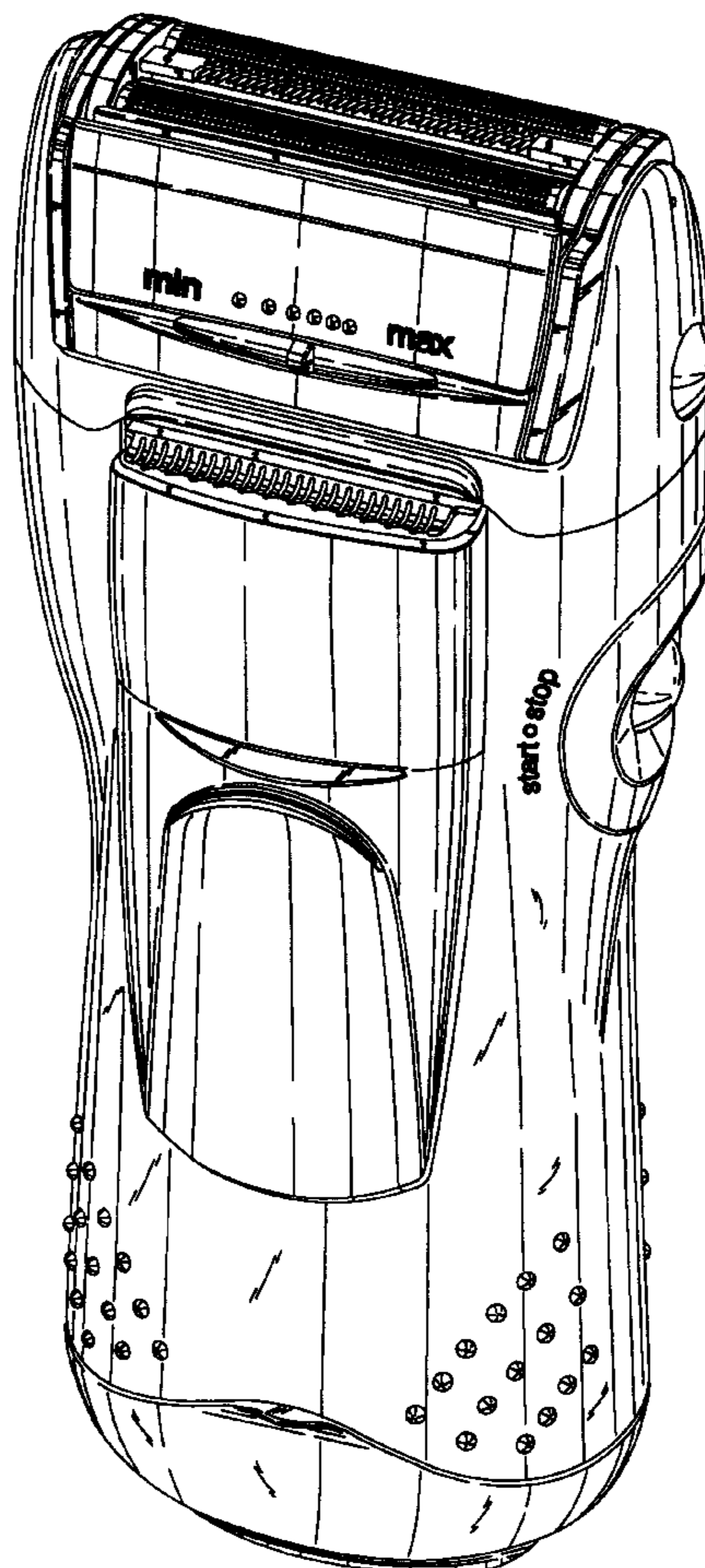

FIG. 1

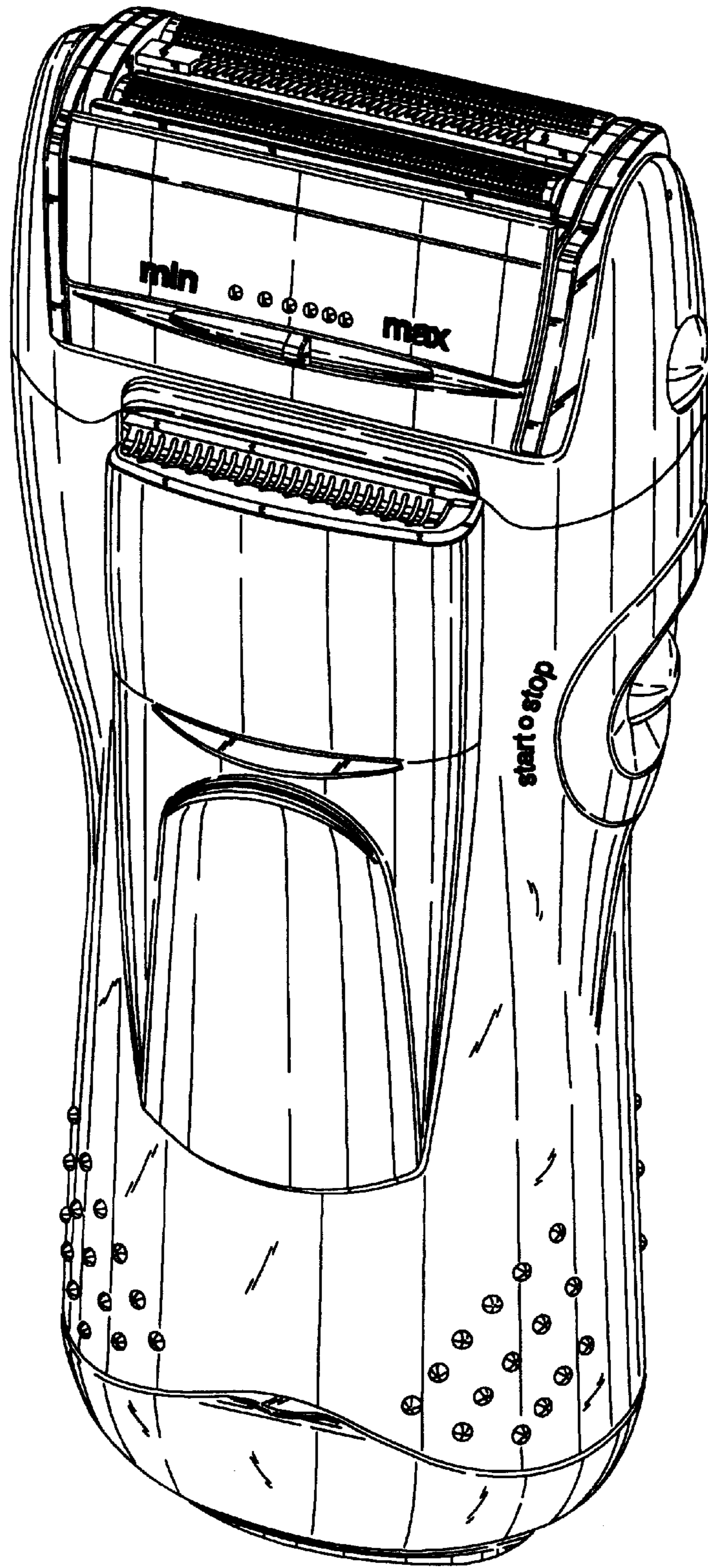

FIG. 2

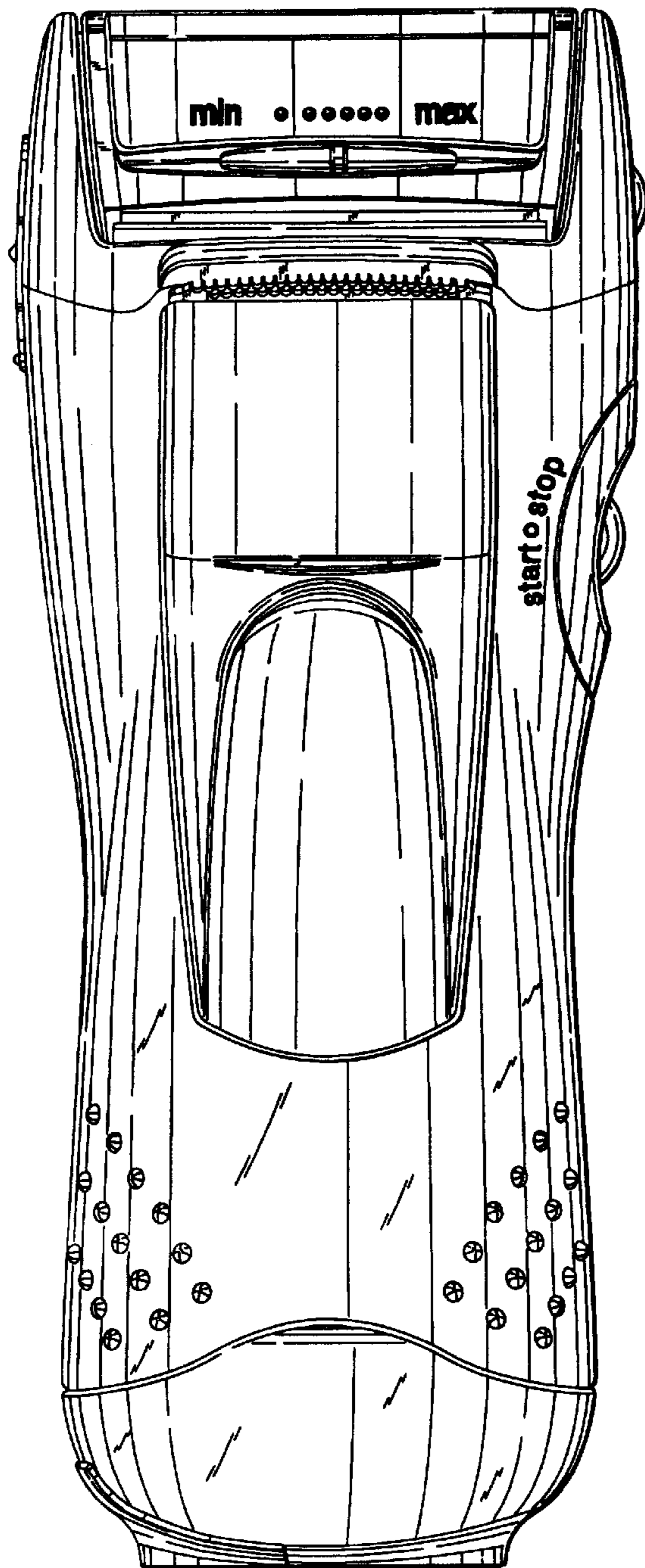

FIG. 3

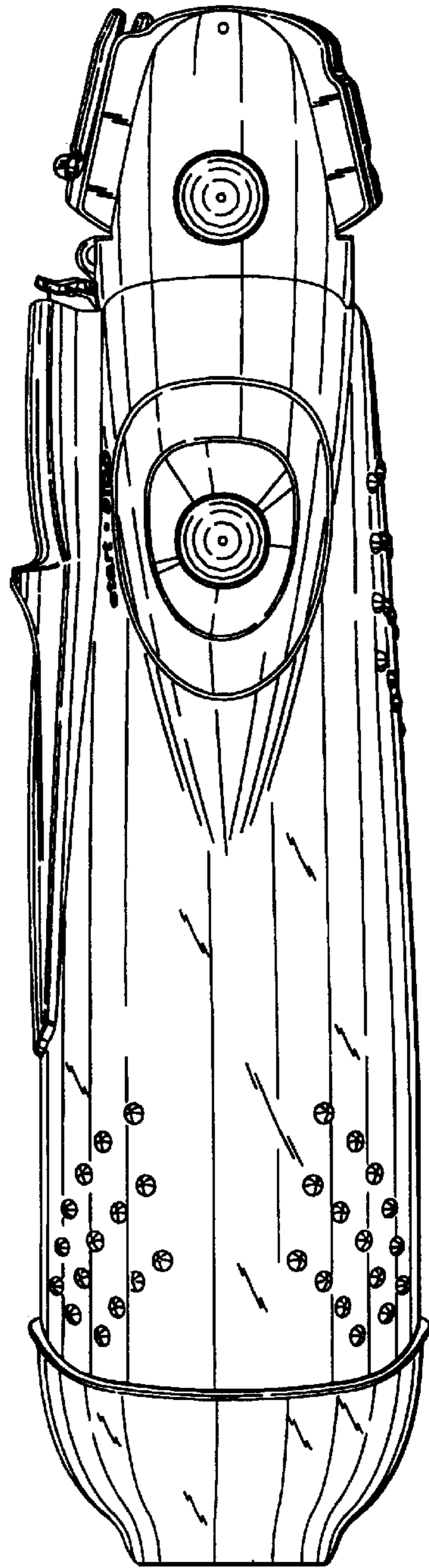

FIG. 4

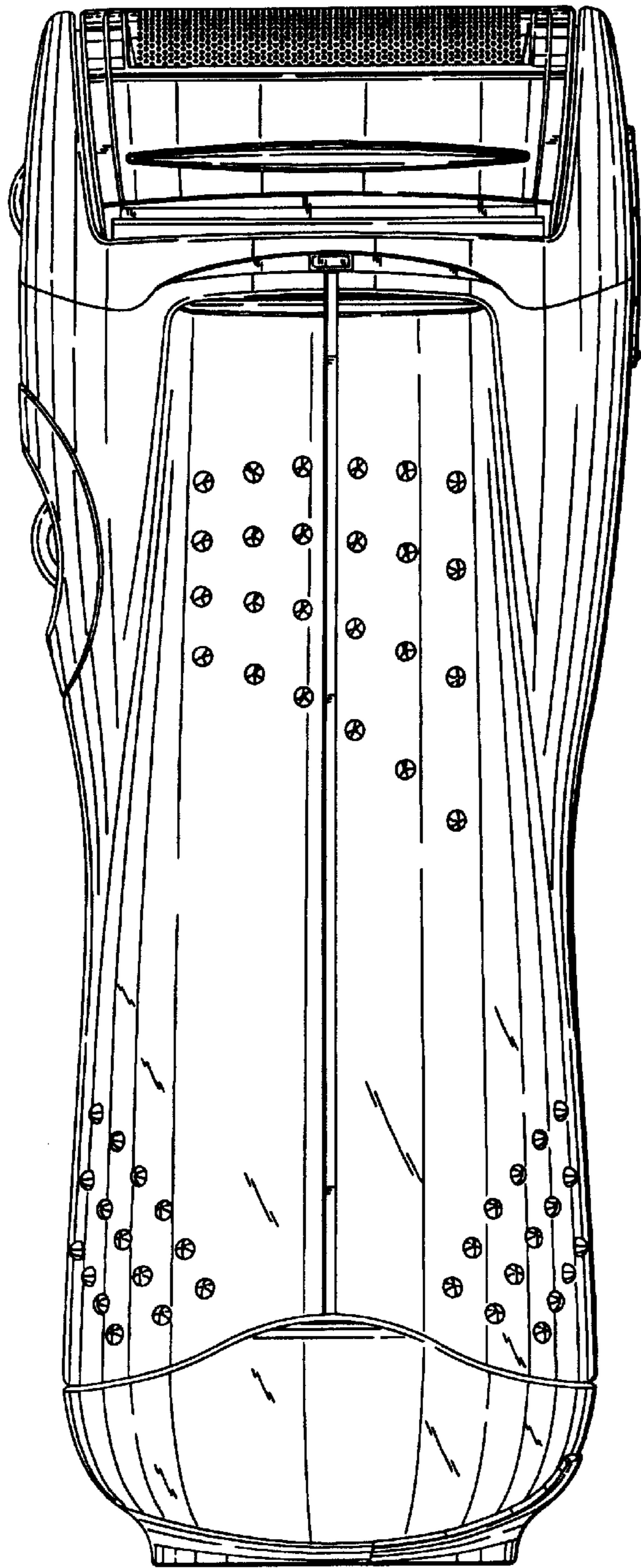

FIG. 5

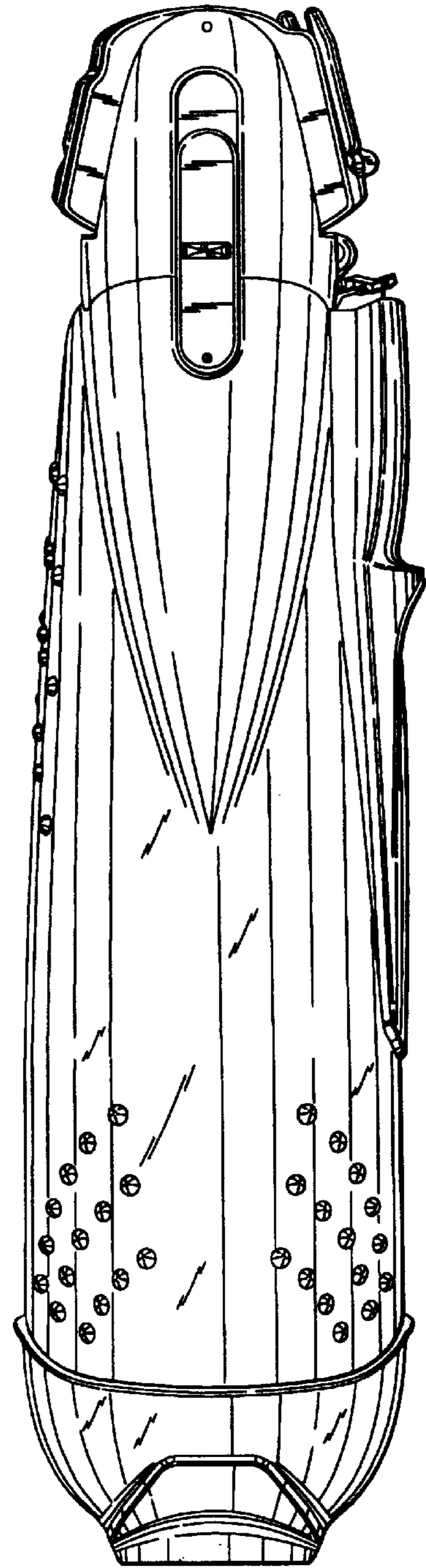

FIG. 6

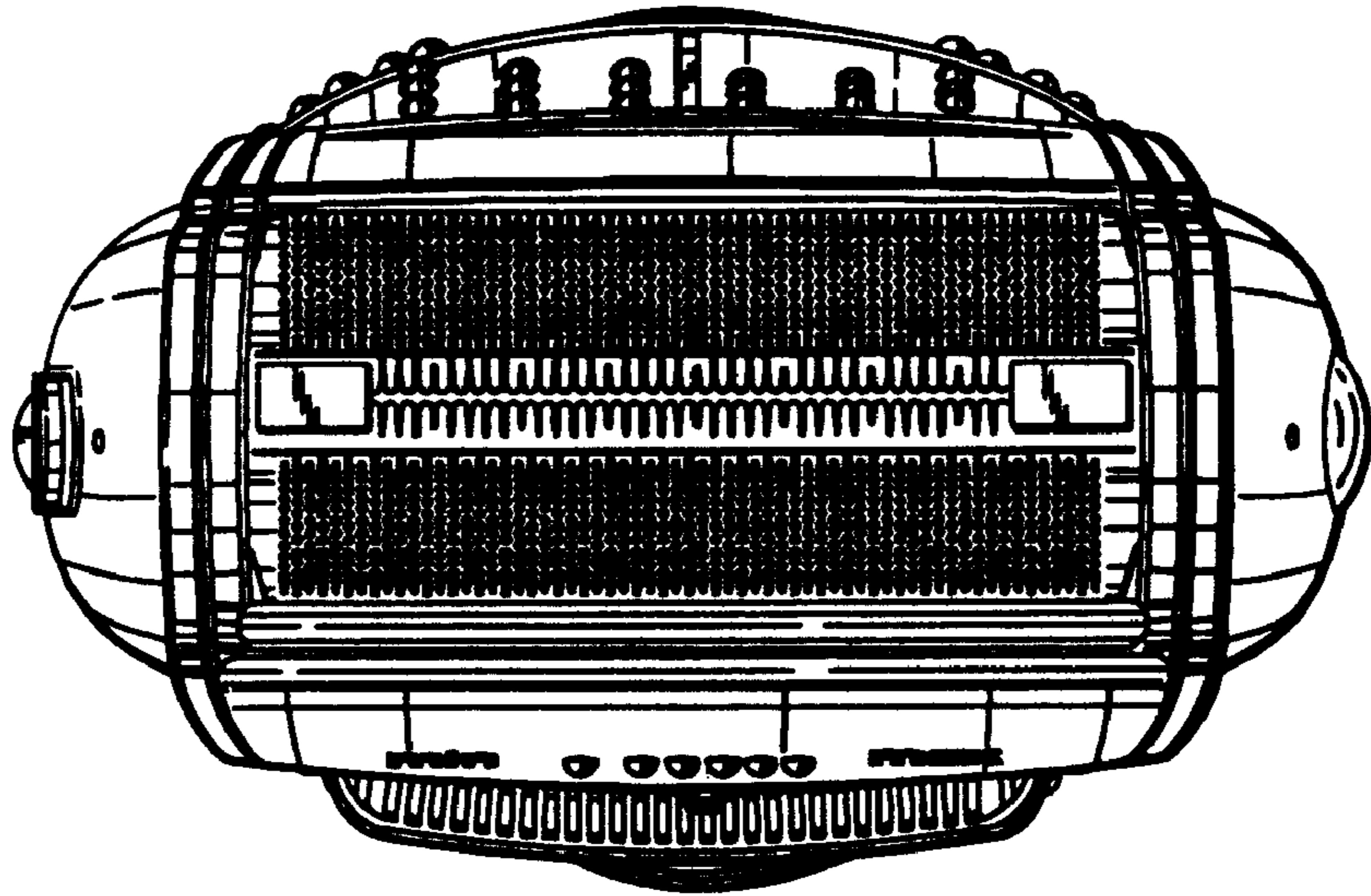

FIG. 7

