



US00D456548S

(12) **United States Design Patent**
Lee

(10) **Patent No.:** **US D456,548 S**

(45) **Date of Patent:** **** Apr. 30, 2002**

(54) **WALL FIXTURE MOUNTING BASE**

(76) Inventor: **Ying-Jue Lee**, 7, Lane 530, Chung Hua Road, Sec. 1, Pa Li, Taipei Hsien (TW)

(**) Term: **14 Years**

(21) Appl. No.: **29/145,476**

(22) Filed: **Jul. 25, 2001**

(51) **LOC (7) Cl.** **26-03**

(52) **U.S. Cl.** **D26/72; D26/85**

(58) **Field of Search** D26/72-74, 81-87, D26/92; 362/147, 432, 363, 367, 368, 404

(56) **References Cited**

U.S. PATENT DOCUMENTS

- D170,188 S * 8/1953 Flood, Jr. D26/81
- D443,380 S * 6/2001 Williams D26/87
- D443,381 S * 6/2001 Williams D26/87

OTHER PUBLICATIONS

HALO/surface Lighting sales brochure; p. 7; "Cone" fixture.*

Louis Poulsen Light & Design Oct. 1991; p. 13; wall sconce in top left of page.*

* cited by examiner

Primary Examiner—Alan P. Douglas

Assistant Examiner—Clare E. Heflin

(74) *Attorney, Agent, or Firm*—Troxell Law Office PLLC

(57) **CLAIM**

The ornamental design for a wall fixture mounting base, as shown.

DESCRIPTION

FIG. 1 is a front perspective view of a wall fixture mounting base showing my new design;

FIG. 2 is a front elevational view thereof;

FIG. 3 is a rear elevational view thereof;

FIG. 4 is a left side elevational view thereof;

FIG. 5 is a right side elevational view thereof;

FIG. 6 is a top plan view thereof; and,

FIG. 7 is a bottom plan view thereof.

1 Claim, 6 Drawing Sheets

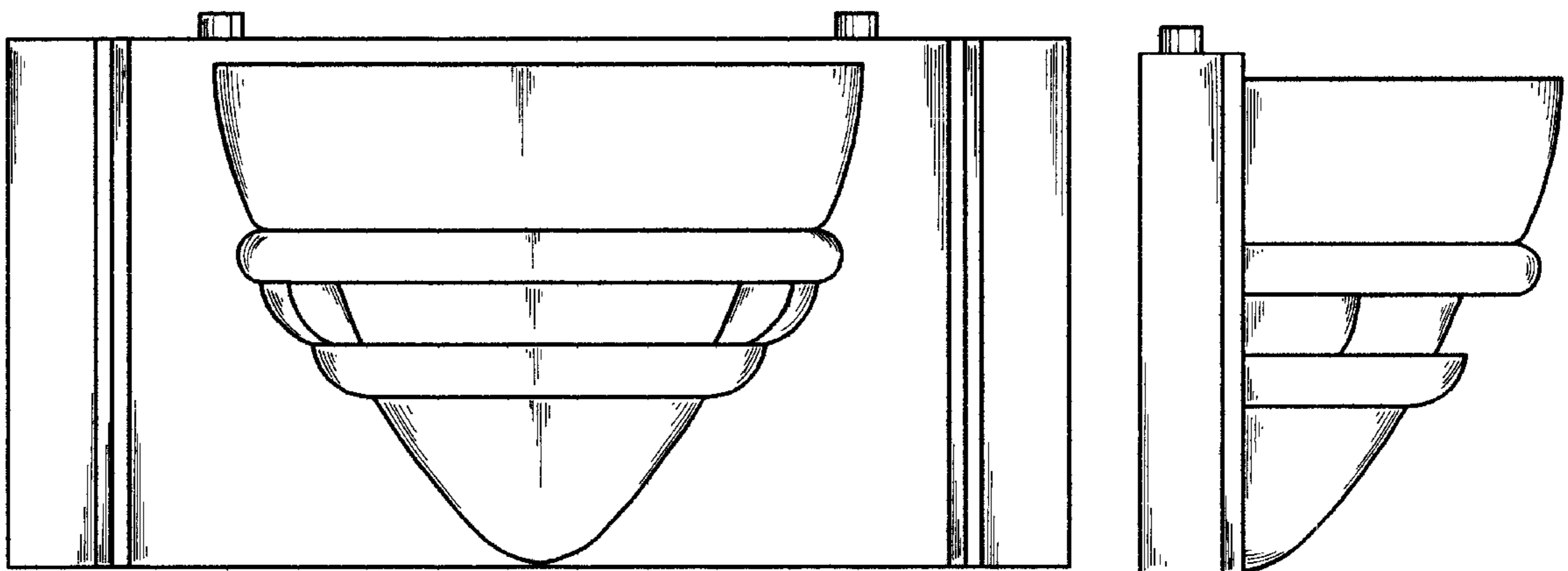

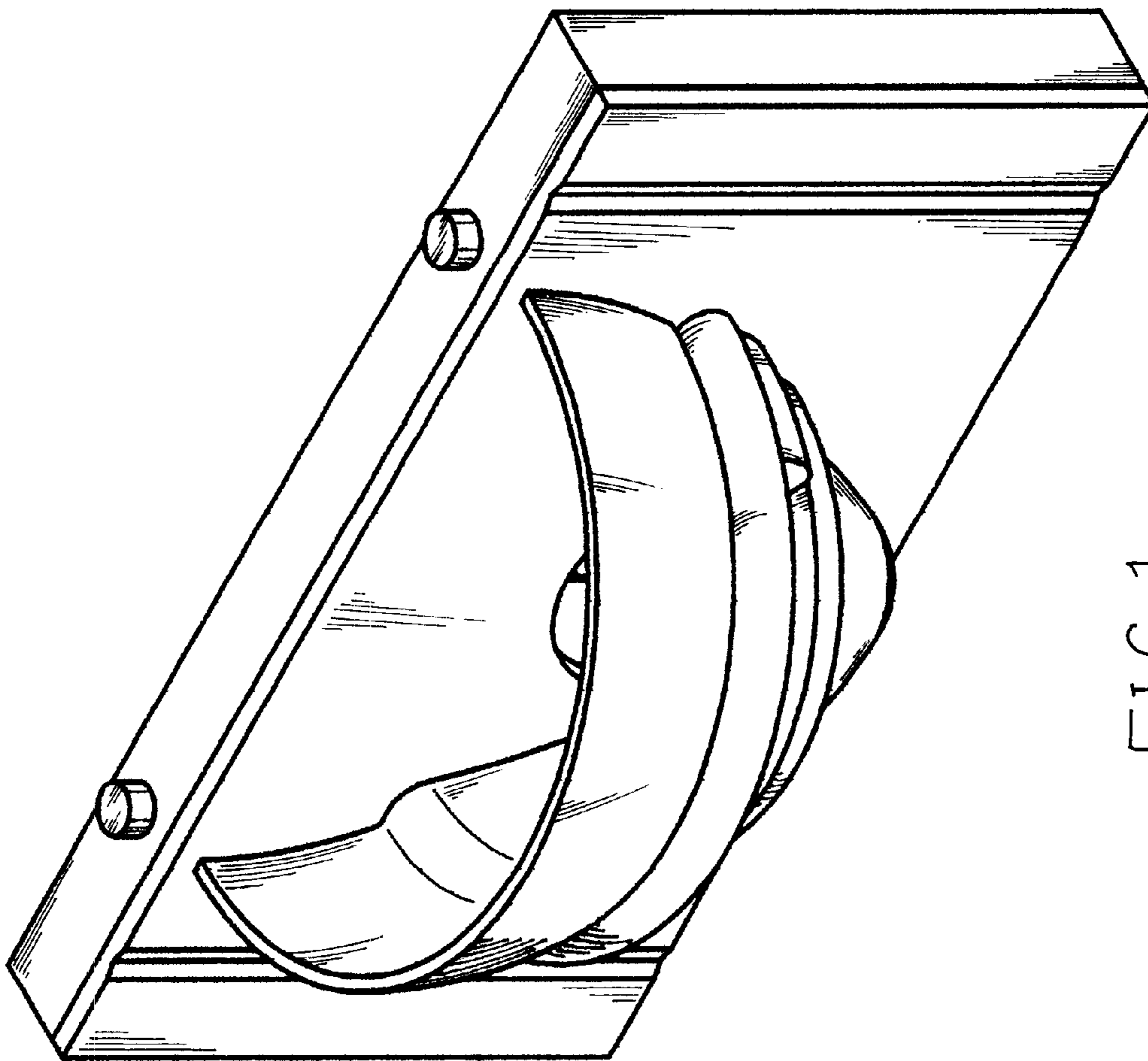

FIG. 1

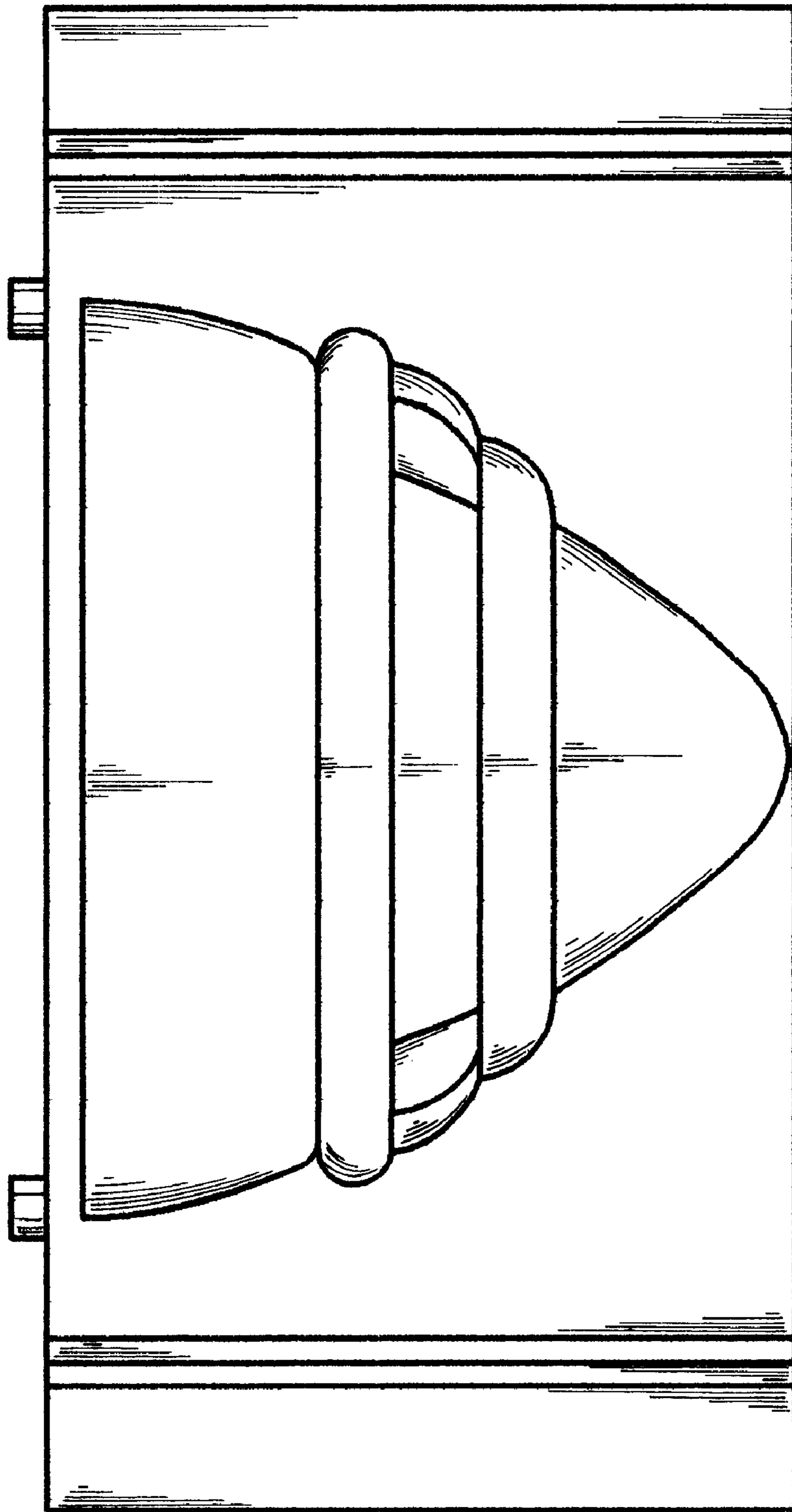

FIG. 2

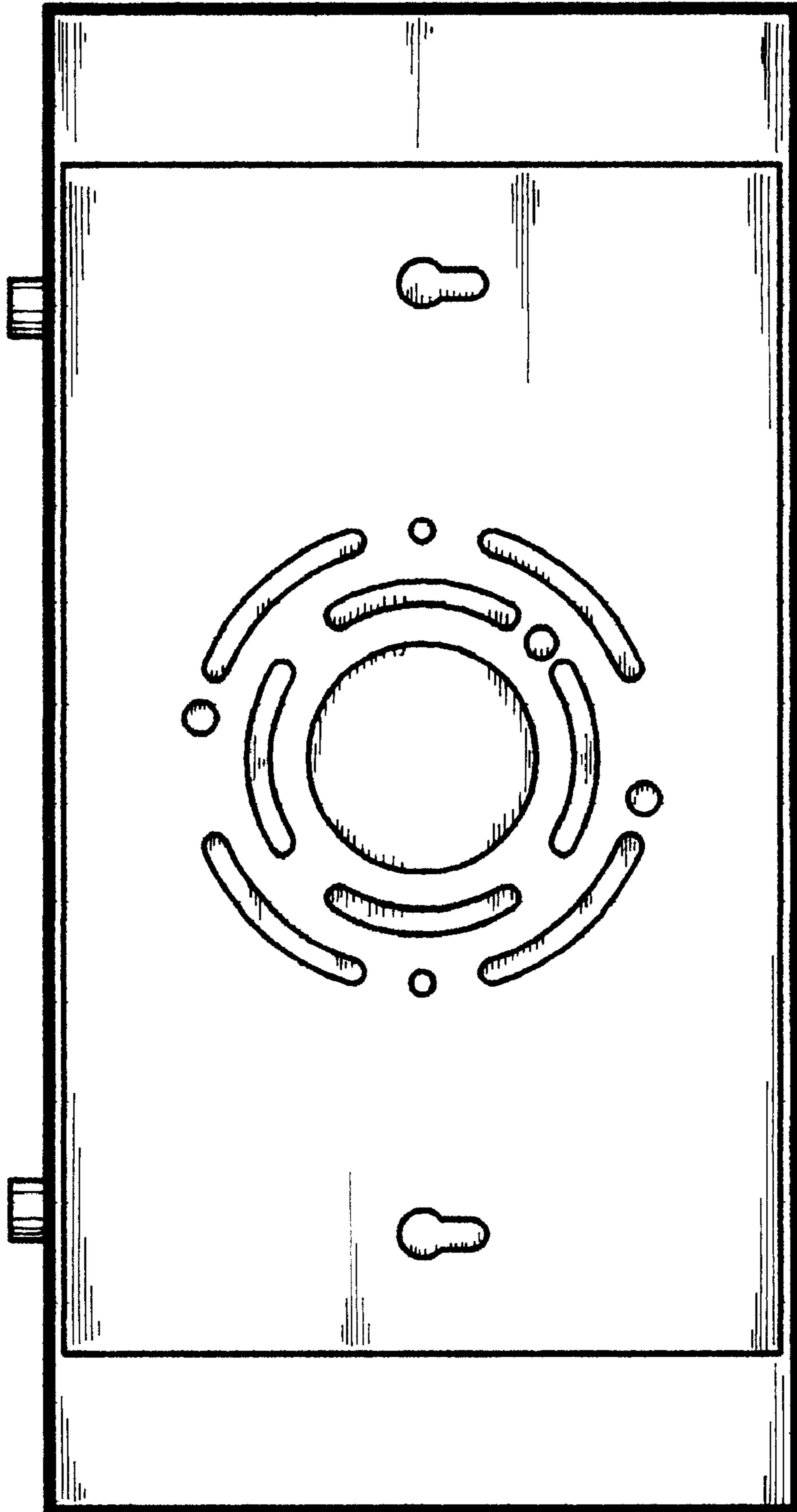

FIG. 3

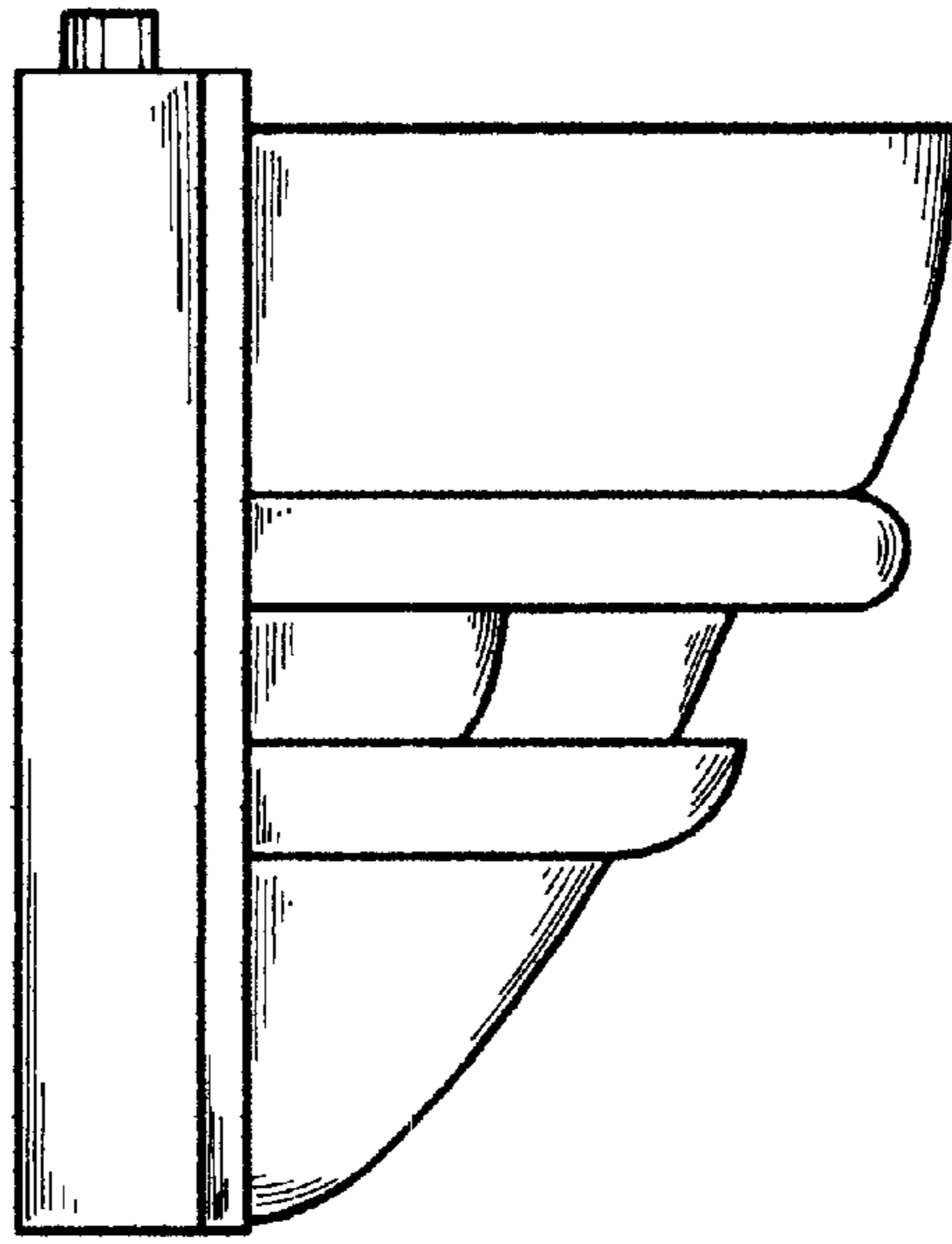

FIG. 4

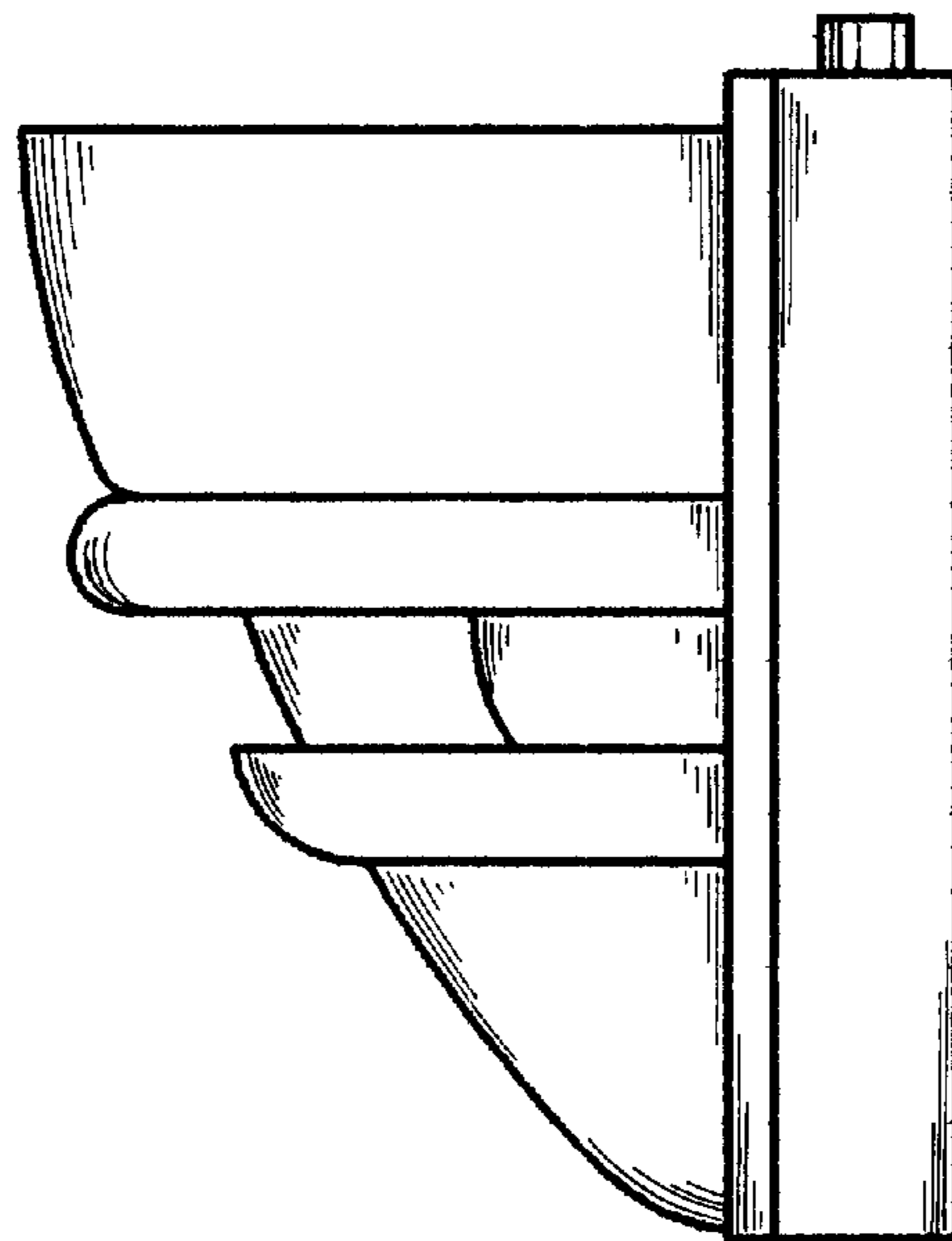

FIG. 5

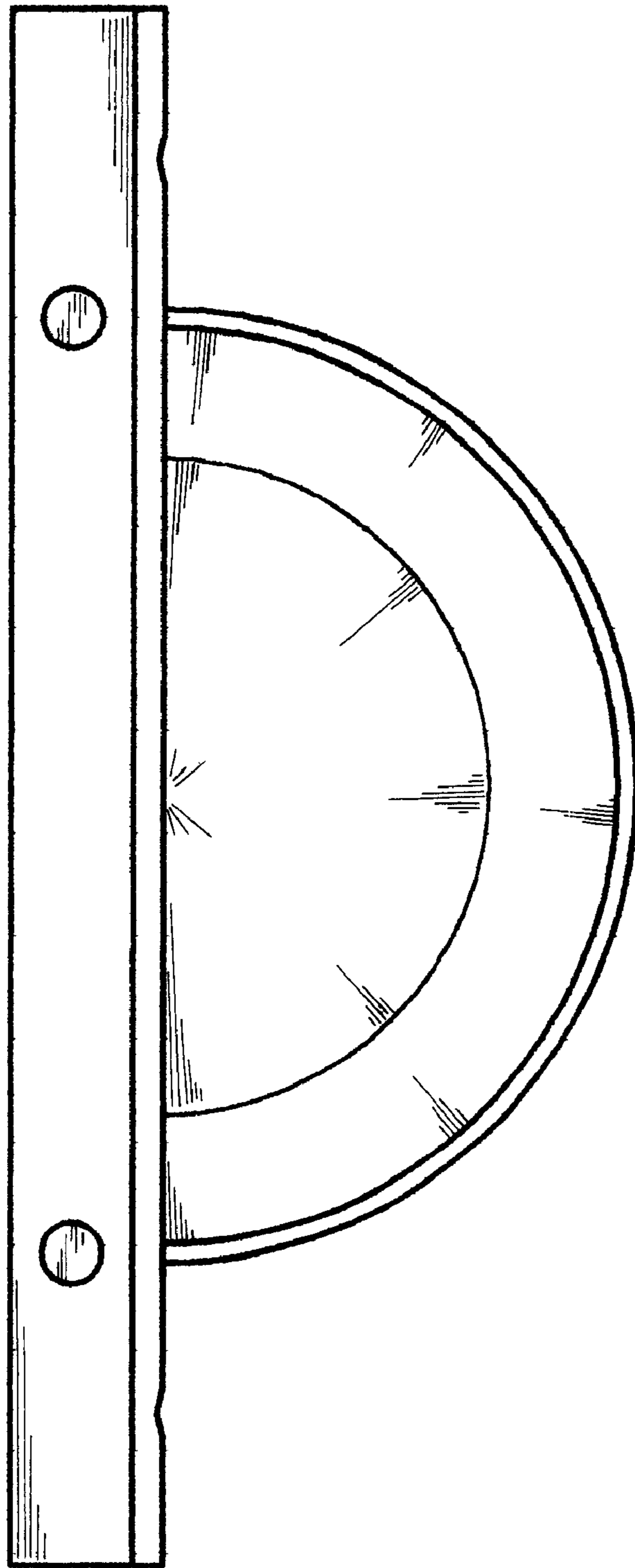

FIG. 6

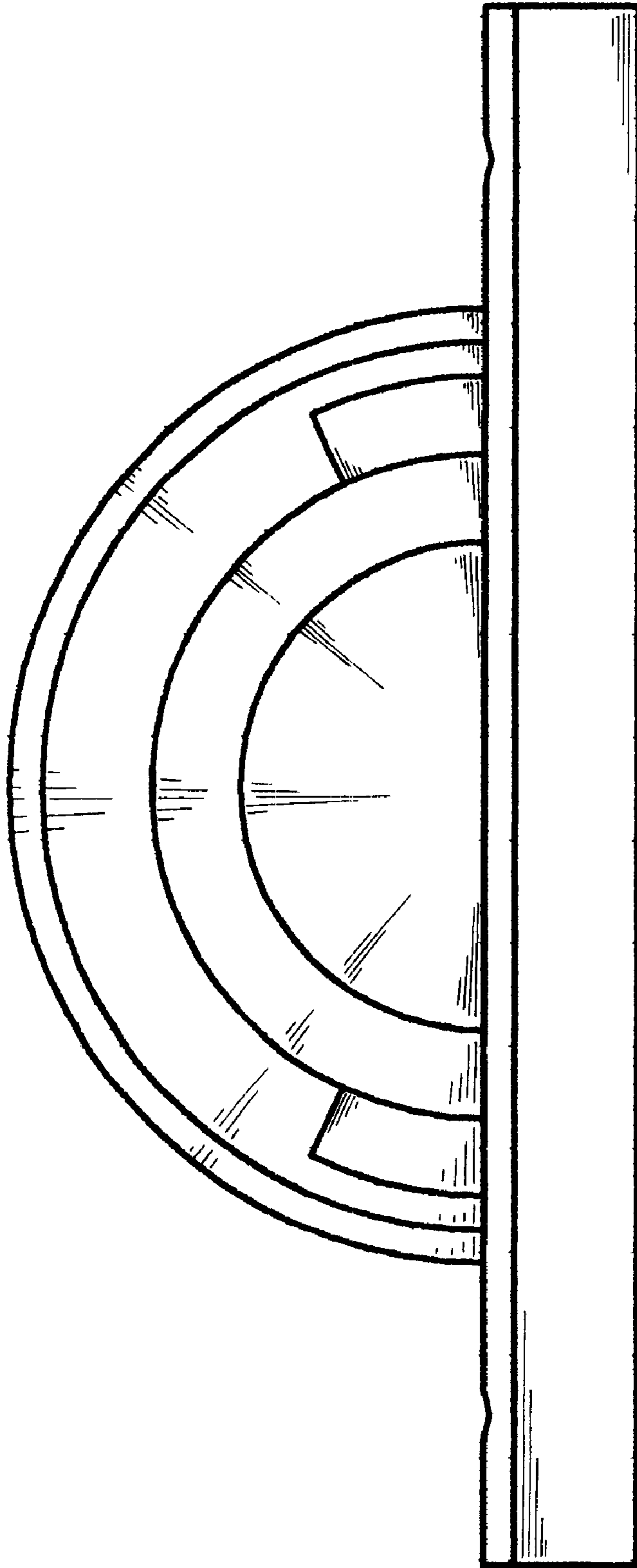

FIG. 7