



US00D456133S

(12) **United States Design Patent**  
**Fiore, Jr.**

(10) **Patent No.:** **US D456,133 S**

(45) **Date of Patent:** **\*\* Apr. 30, 2002**

(54) **ARCHER'S CASE**

(75) Inventor: **Joseph F. Fiore, Jr.**, Lebanon, PA (US)

(73) Assignee: **Plano Molding Company**, Plano, IL (US)

(\*\*) Term: **14 Years**

(21) Appl. No.: **29/131,494**

(22) Filed: **Oct. 23, 2000**

(51) **LOC (7) Cl.** ..... **03-01**

(52) **U.S. Cl.** ..... **D3/254**

(58) **Field of Search** ..... D3/254, 262, 204,  
D3/273, 276, 285, 289; 206/315.11, 317,  
579, 314, 315.1; 224/577, 150

(56) **References Cited**

**U.S. PATENT DOCUMENTS**

|            |   |         |                    |       |        |
|------------|---|---------|--------------------|-------|--------|
| D222,688 S | * | 11/1971 | Canton             | ..... | D3/254 |
| D246,138 S |   | 10/1977 | Christensen et al. | ..... | D3/254 |
| D343,057 S |   | 1/1994  | Dickinson          | ..... | D3/254 |
| D358,254 S |   | 5/1995  | VanSkiver          | ..... | D3/254 |
| D389,643 S | * | 1/1998  | Stratton           | ..... | D3/254 |
| D448,165 S | * | 9/2001  | Kolpin             | ..... | D3/262 |

**OTHER PUBLICATIONS**

Doskocil Mfg. Co. 1995 Gun Guard Quality Sporting Cases Catalog, p. 13 (Archery Edition).  
Woodstream (an EKCO Group Company) 1991 Hunting and Shooting Accessories Catalog, (Inside cover—Field Locker), p. 2.

Kolpin Mfg., Inc. 1997 Hunting Products Catalog, p. 15 (Gator Hard-Sided Bow Cases).

\* cited by examiner

*Primary Examiner*—Catherine R. Oliver  
(74) *Attorney, Agent, or Firm*—Vedder, Price, Kaufman & Kammholz

(57) **CLAIM**

The ornamental design for an archer's case, as shown and described.

**DESCRIPTION**

FIG. 1 is a perspective view of the archer's case showing the claimed design;

FIG. 2 is a top view of my invention;

FIG. 3 is a front view of my invention;

FIG. 4 is a bottom view of my invention;

FIG. 5 is a rear view of my invention;

FIG. 6 is a side view of my invention; and,

FIG. 7 is an opposite side view of my invention.

**1 Claim, 4 Drawing Sheets**

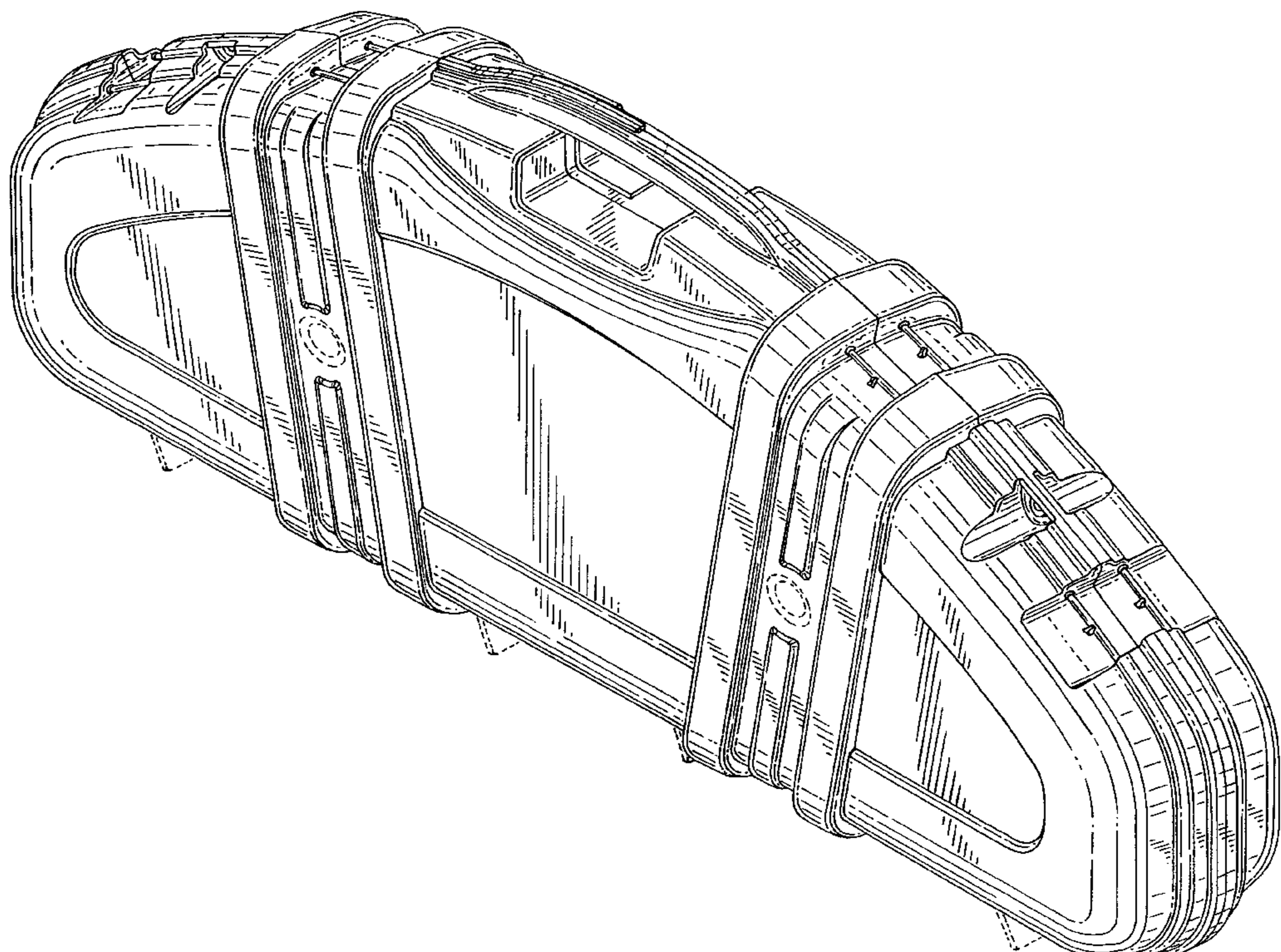

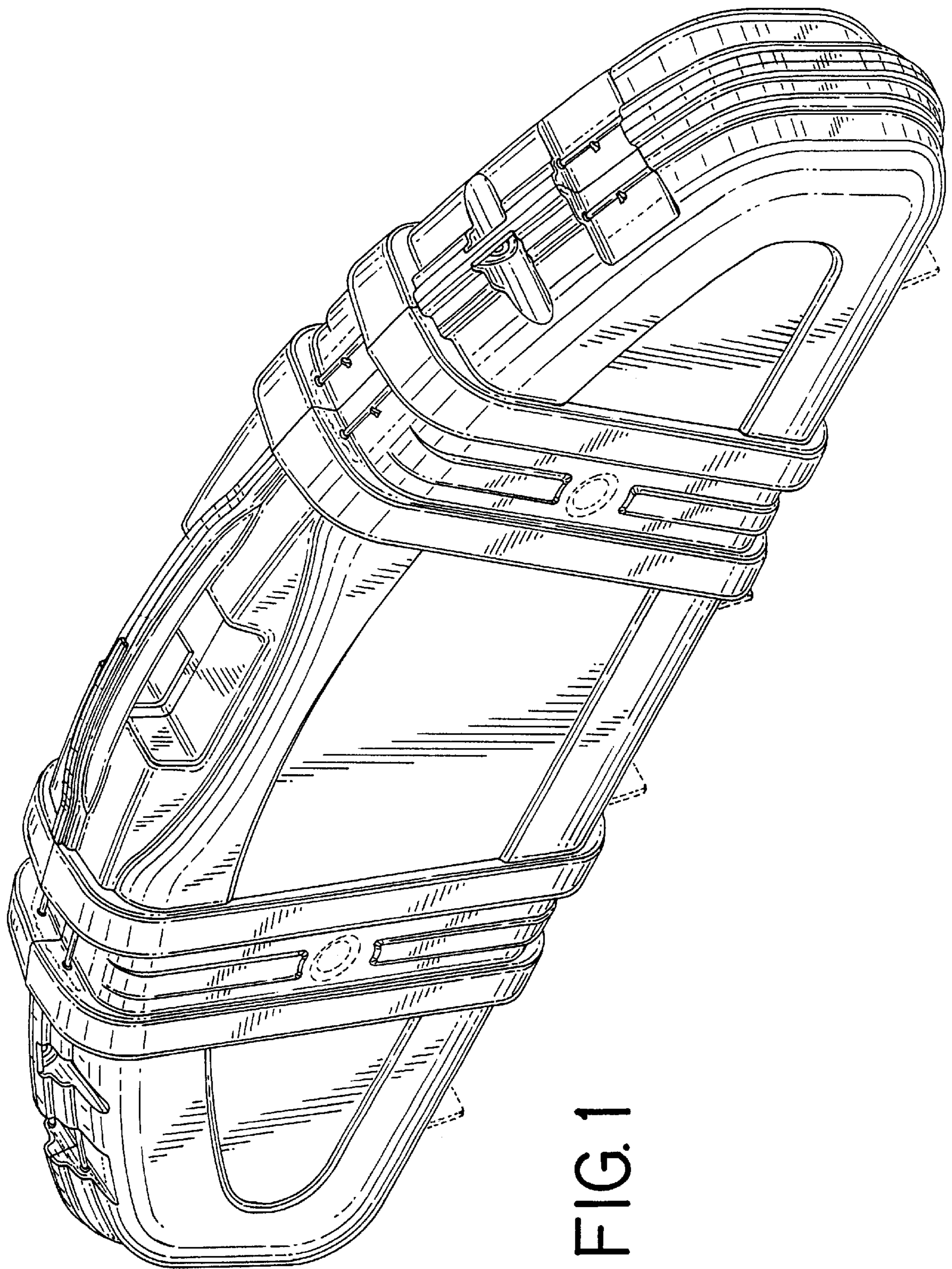

FIG. 1

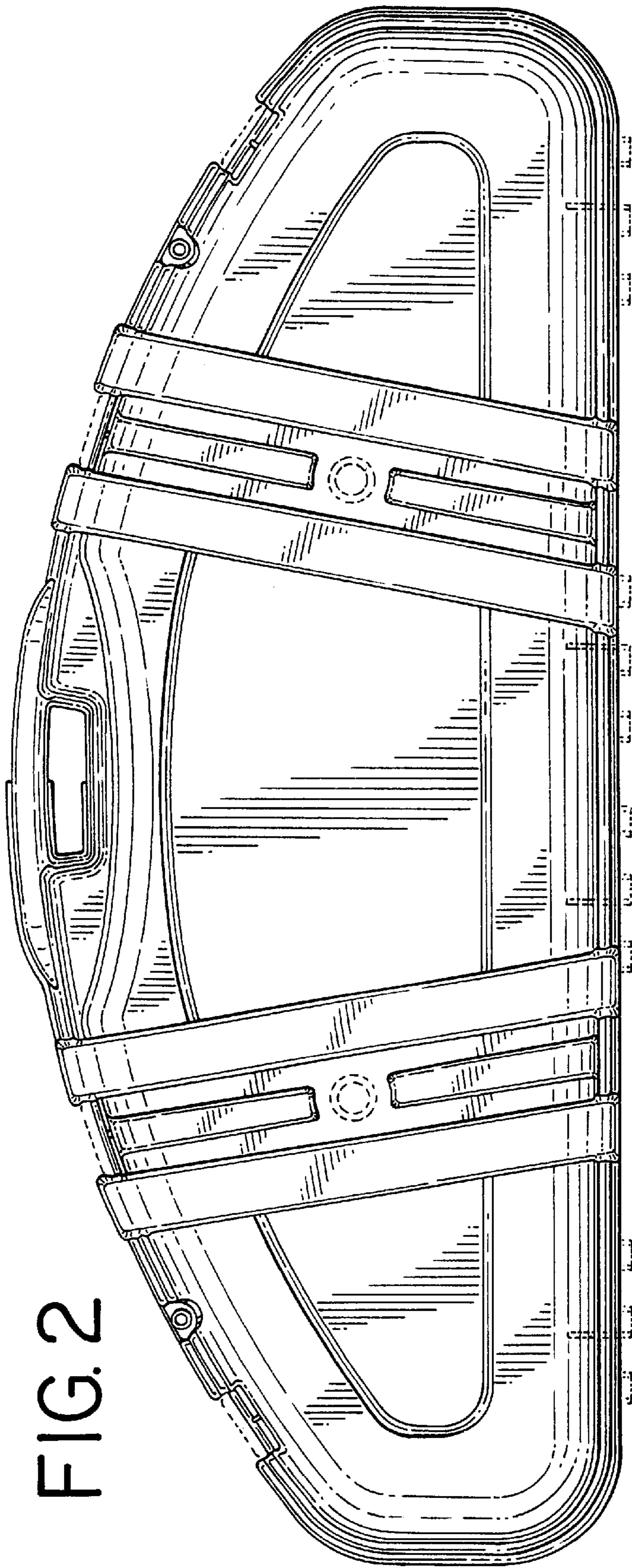
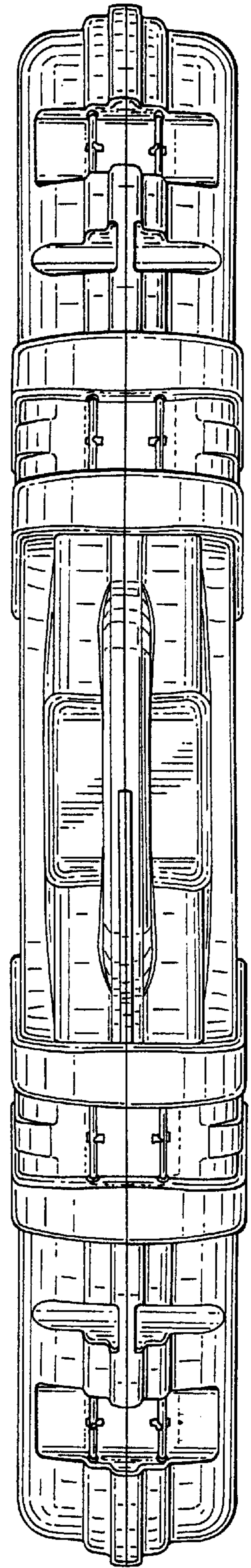

FIG. 2

FIG. 3



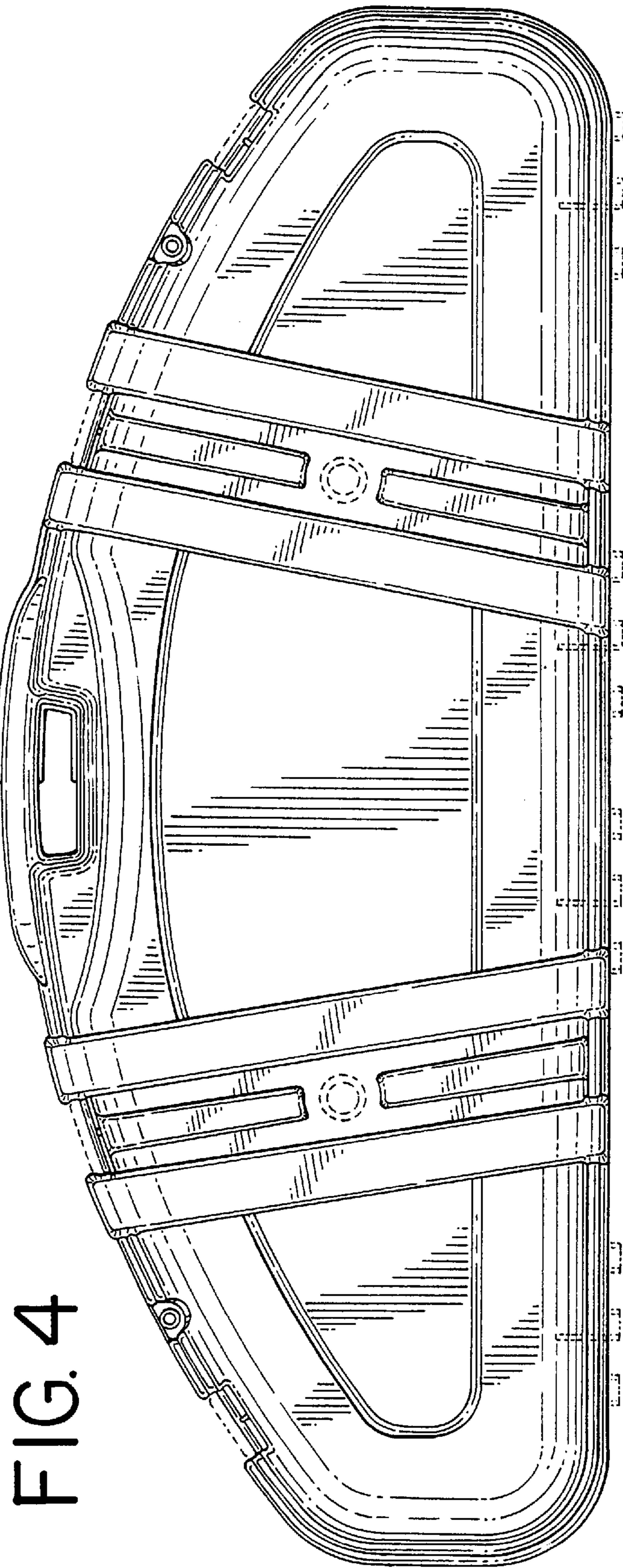

FIG. 4

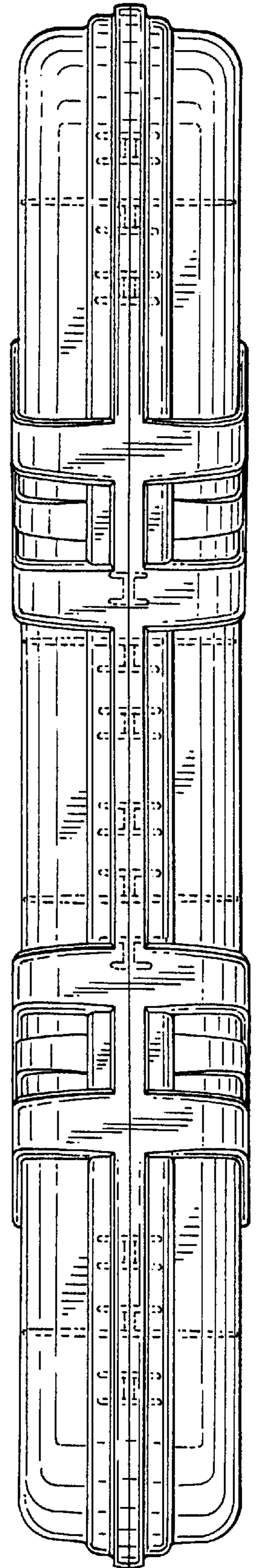

FIG. 5

FIG. 6

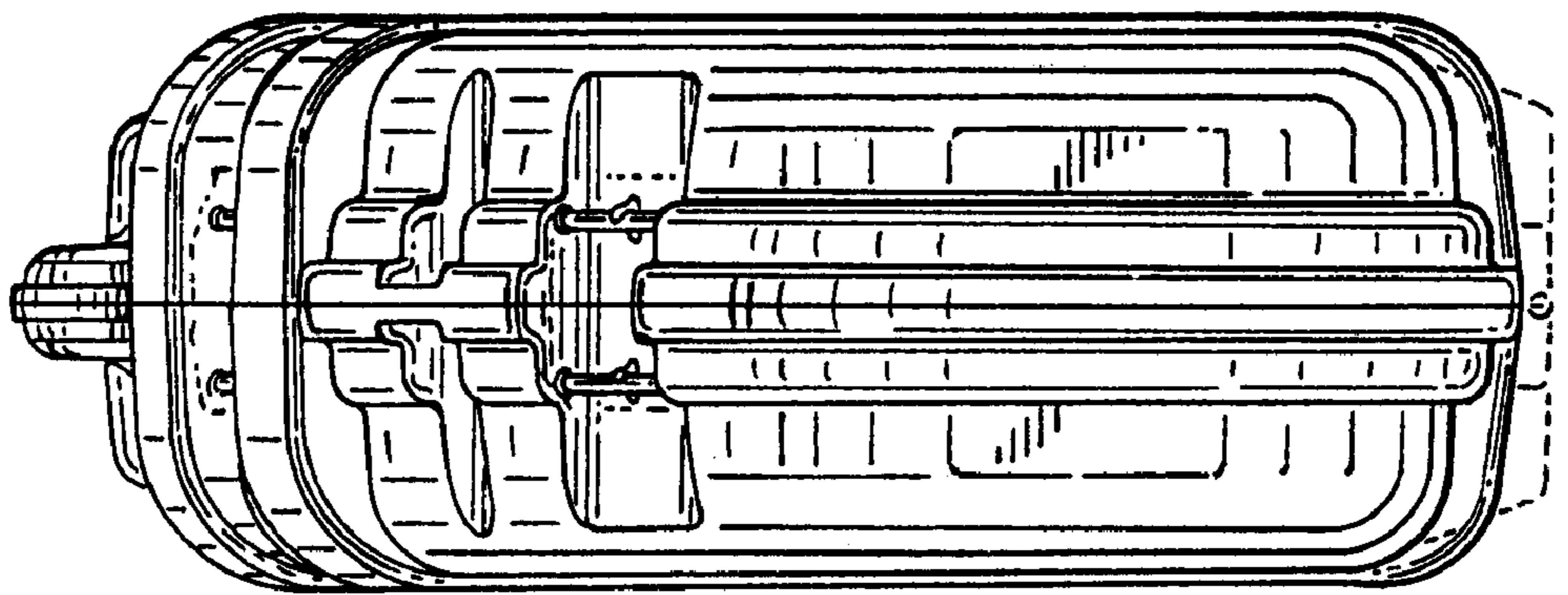

FIG. 7

