



US00D455994S

(12) **United States Design Patent**
Syfritt

(10) **Patent No.:** **US D455,994 S**

(45) **Date of Patent:** **** Apr. 23, 2002**

(54) **BOAT**

5,522,333 A * 6/1996 Lang et al. 114/61.1

(76) Inventor: **Hal Syfritt**, 2003 S. Mesa St., San
Pedro, CA (US) 90731-5515

* cited by examiner

(**) Term: **14 Years**

Primary Examiner—Lisa Lichtenstein
(74) *Attorney, Agent, or Firm*—Neil F. Markva

(21) Appl. No.: **29/129,856**

(57) **CLAIM**

(22) Filed: **Sep. 22, 2000**

The ornamental design for a boat, as shown and described.

(51) **LOC (7) Cl.** **12-06**

(52) **U.S. Cl.** **D12/300**

(58) **Field of Search** D12/300-318;
114/61.1, 61.2, 61.11, 349, 66, 71

DESCRIPTION

FIG. 1 is a perspective view of a boat showing my new design;
FIG. 2 is a top view thereof;
FIG. 3 is a right side elevational view thereof, the opposite side being a mirror image of that shown;
FIG. 4 is a front view thereof;
FIG. 5 is a rear view thereof; and,
FIG. 6 is a bottom perspective view thereof.

(56) **References Cited**

U.S. PATENT DOCUMENTS

1,149,217 A * 10/1915 Pinter 114/349
2,714,865 A * 8/1955 Ward et al. 114/349
D272,060 S * 1/1984 Tremiti, Jr. D12/315

1 Claim, 4 Drawing Sheets

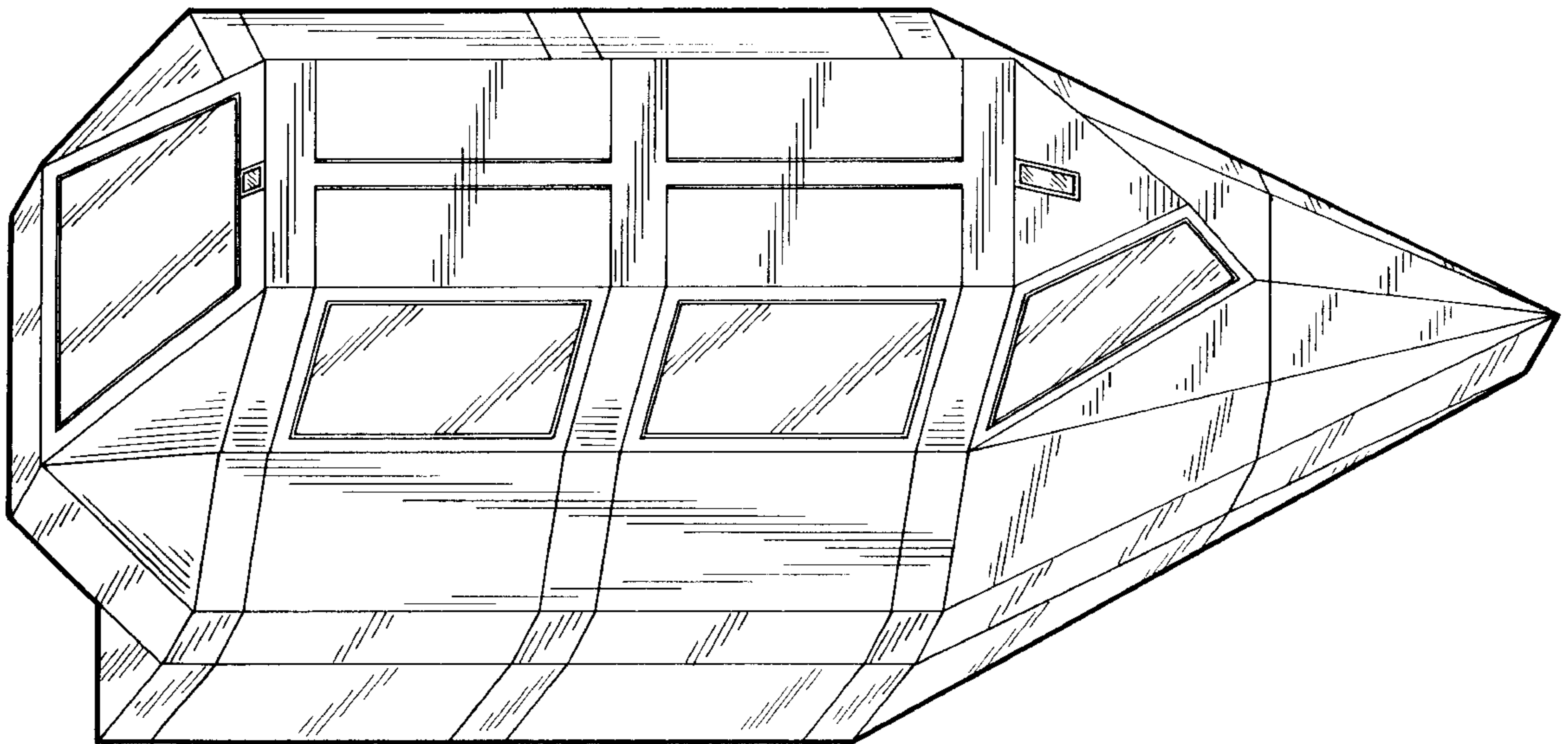

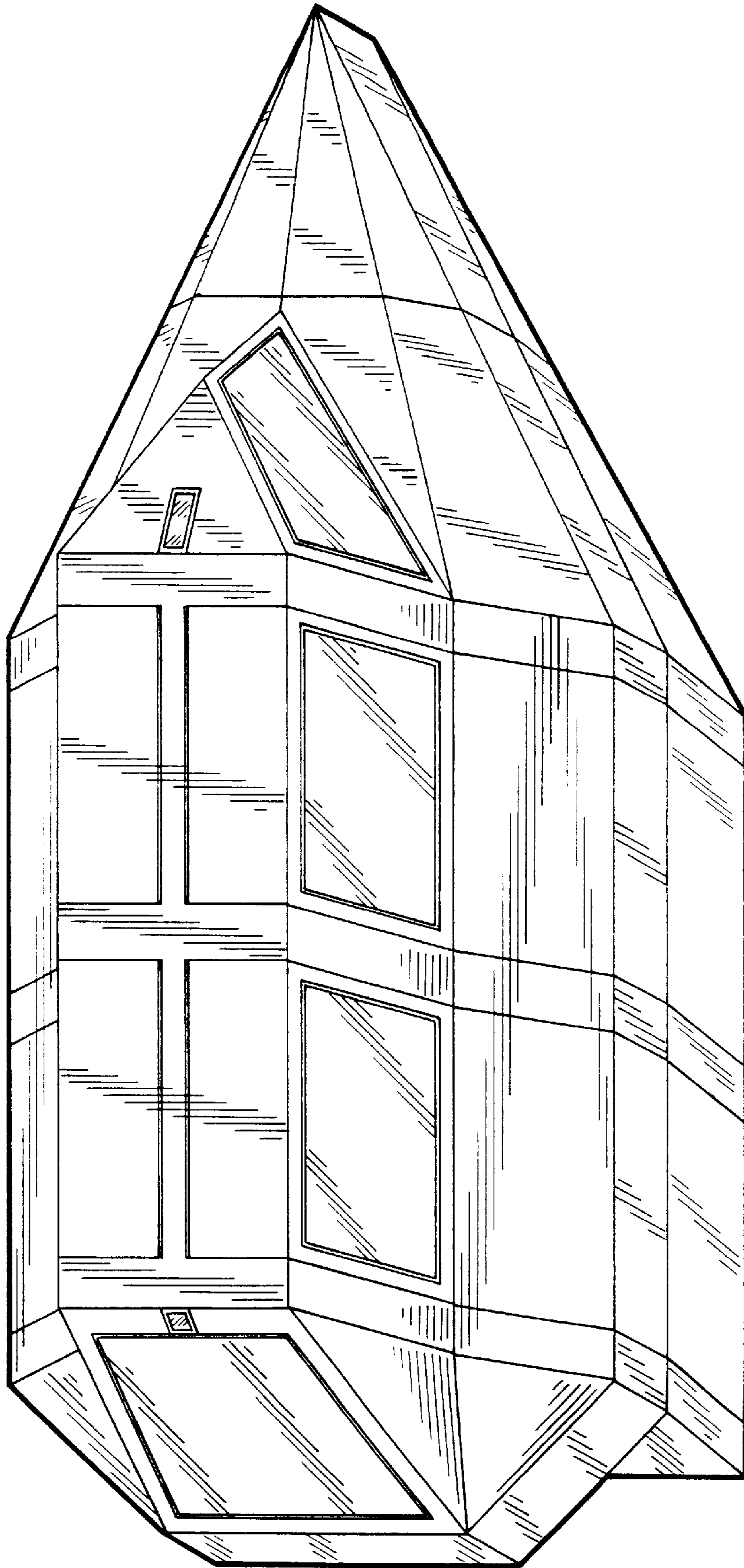

Fig. 1

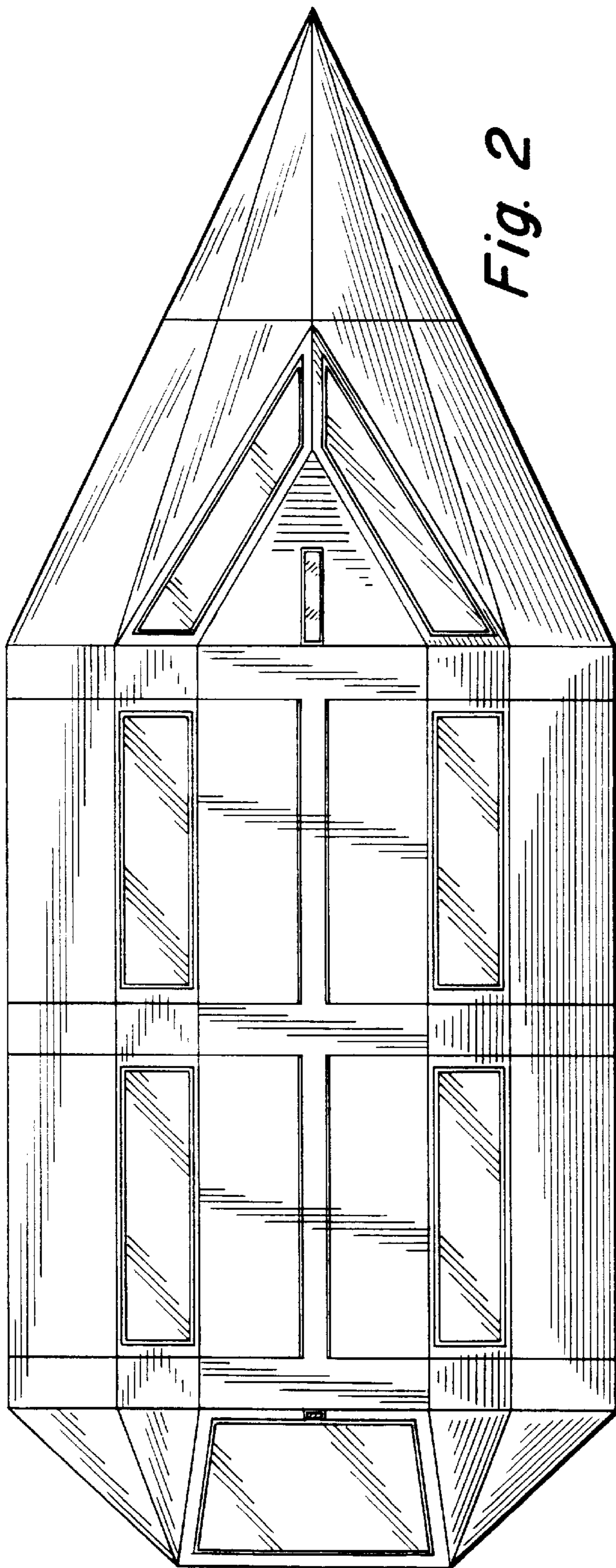

Fig. 2

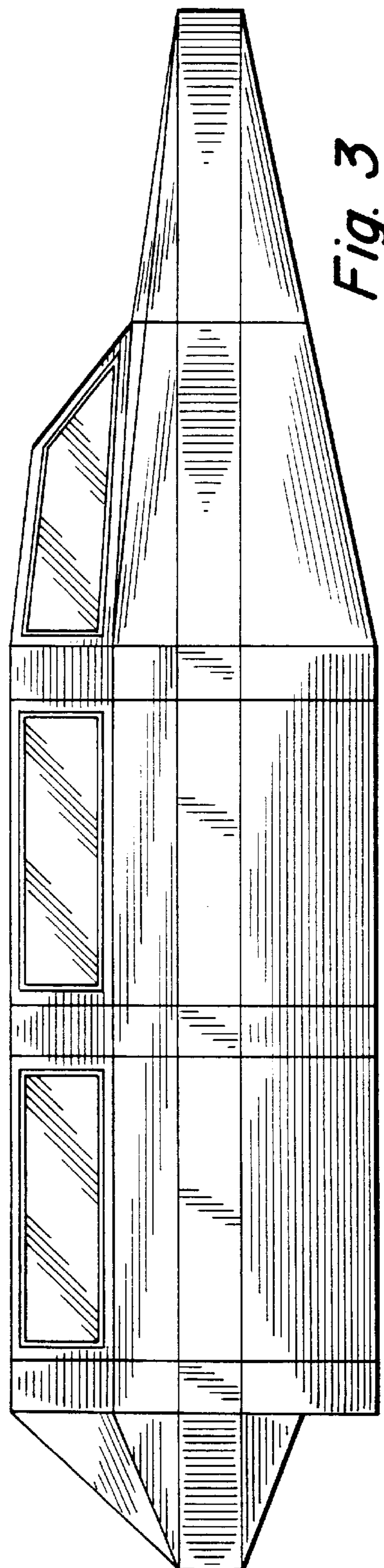

Fig. 3

Fig. 4

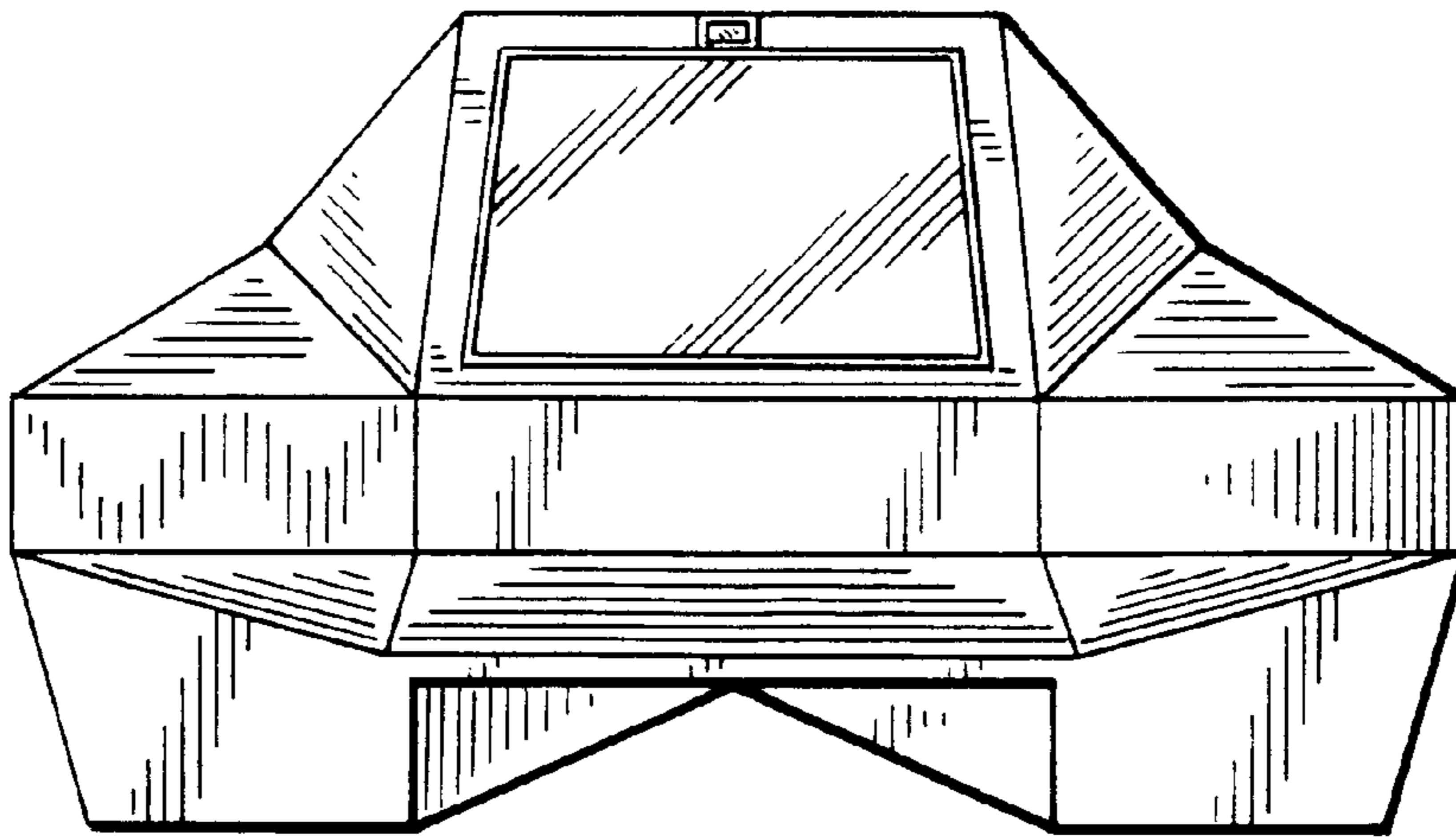
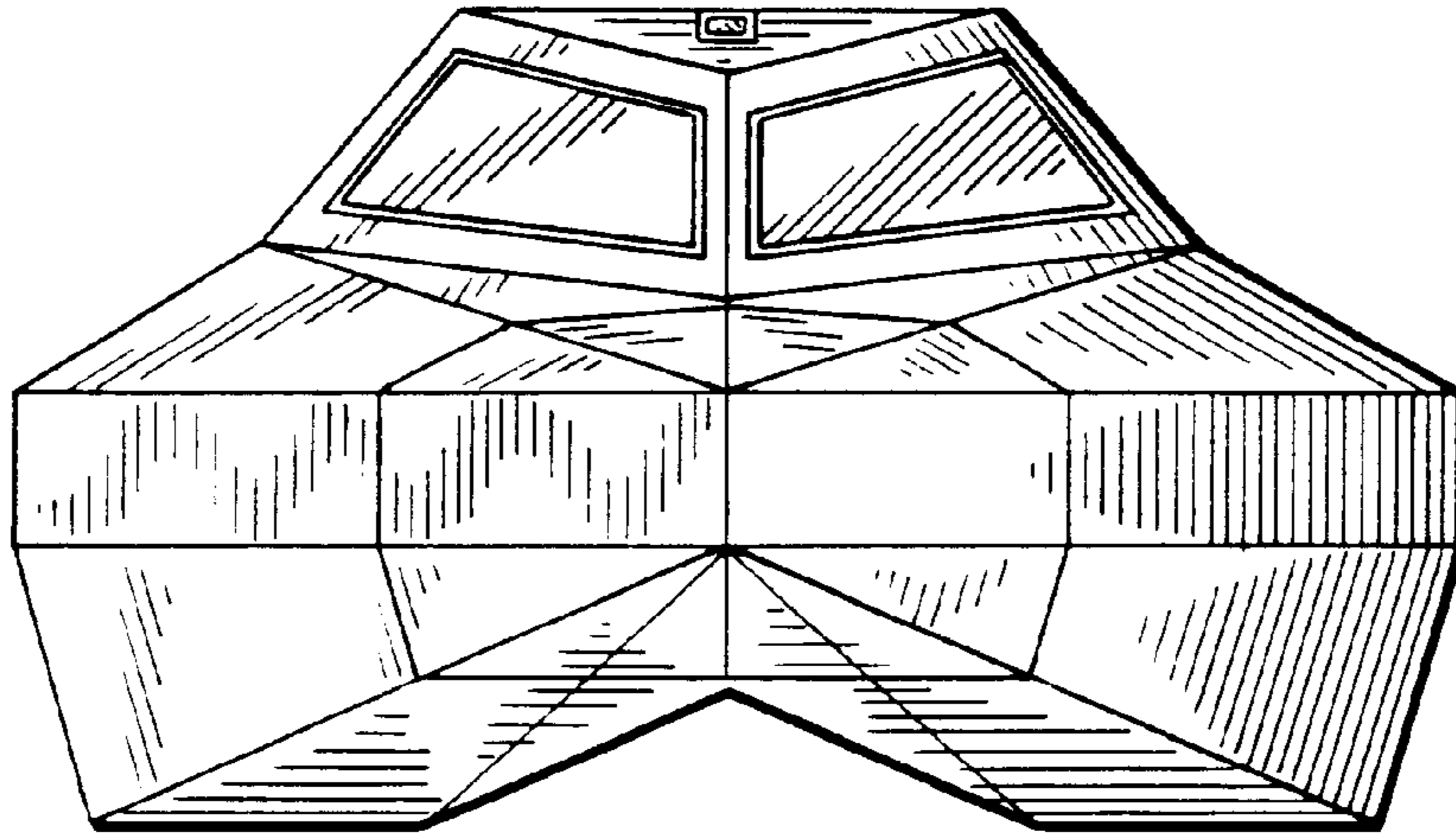

Fig. 5

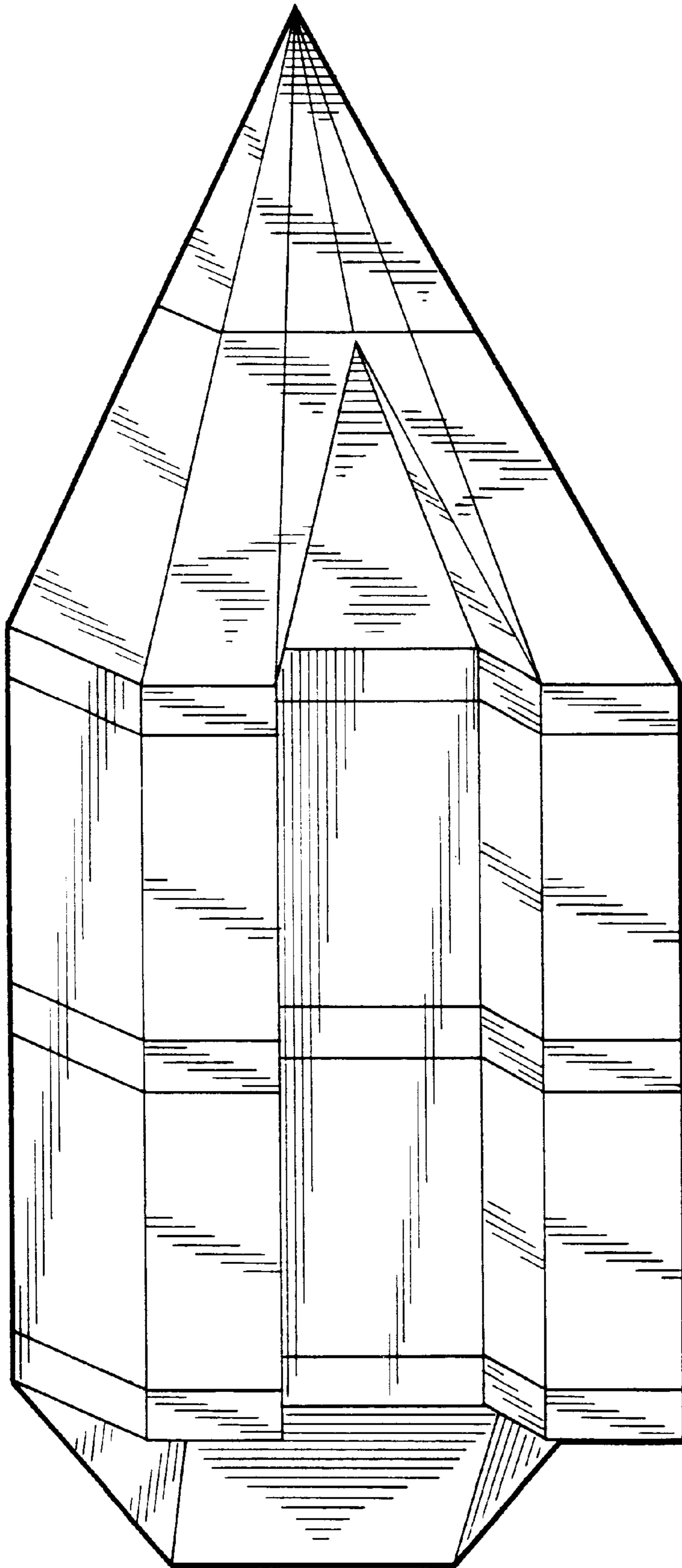

Fig. 6