



US00D455805S

(12) **United States Design Patent**  
**Mills**

(10) **Patent No.:** **US D455,805 S**

(45) **Date of Patent:** **\*\* Apr. 16, 2002**

(54) **GOLF PUTTER HEAD**

(76) Inventor: **David Foster Mills**, 1310 Forest Oaks  
La., Tuscaloosa, AL (US) 35406

(\*\*) Term: **14 Years**

(21) Appl. No.: **29/133,316**

(22) Filed: **Nov. 28, 2000**

(51) **LOC (7) Cl.** ..... **21-02**

(52) **U.S. Cl.** ..... **D21/736**

(58) **Field of Search** ..... D21/736-746;  
473/324, 327, 328, 340, 341, 251-256

(56) **References Cited**

**U.S. PATENT DOCUMENTS**

D212,890 S	*	12/1968	Rose	.....	D21/739
D303,276 S	*	9/1989	Oakleaf	.....	D21/739
D326,303 S	*	5/1992	Cameron	.....	D21/743
D380,245 S	*	6/1997	Meyer	.....	D21/743
D396,258 S	*	7/1998	Sheets	.....	D21/742
D404,451 S	*	1/1999	Sheets	.....	D21/746

\* cited by examiner

*Primary Examiner*—Mitchell Siegel

(74) *Attorney, Agent, or Firm*—Troutman Sanders, LLP;  
Gerald R. Boss

(57) **CLAIM**

The ornamental design for a golf putter head, as shown and described.

**DESCRIPTION**

FIG. 1 is a perspective view of a golf putter head showing my new design;

FIG. 2 is a bottom view thereof;

FIG. 3 is a top view thereof;

FIG. 4 is a sectional view taken along line 4—4 of FIG. 3;

FIG. 5 is a rear elevational view;

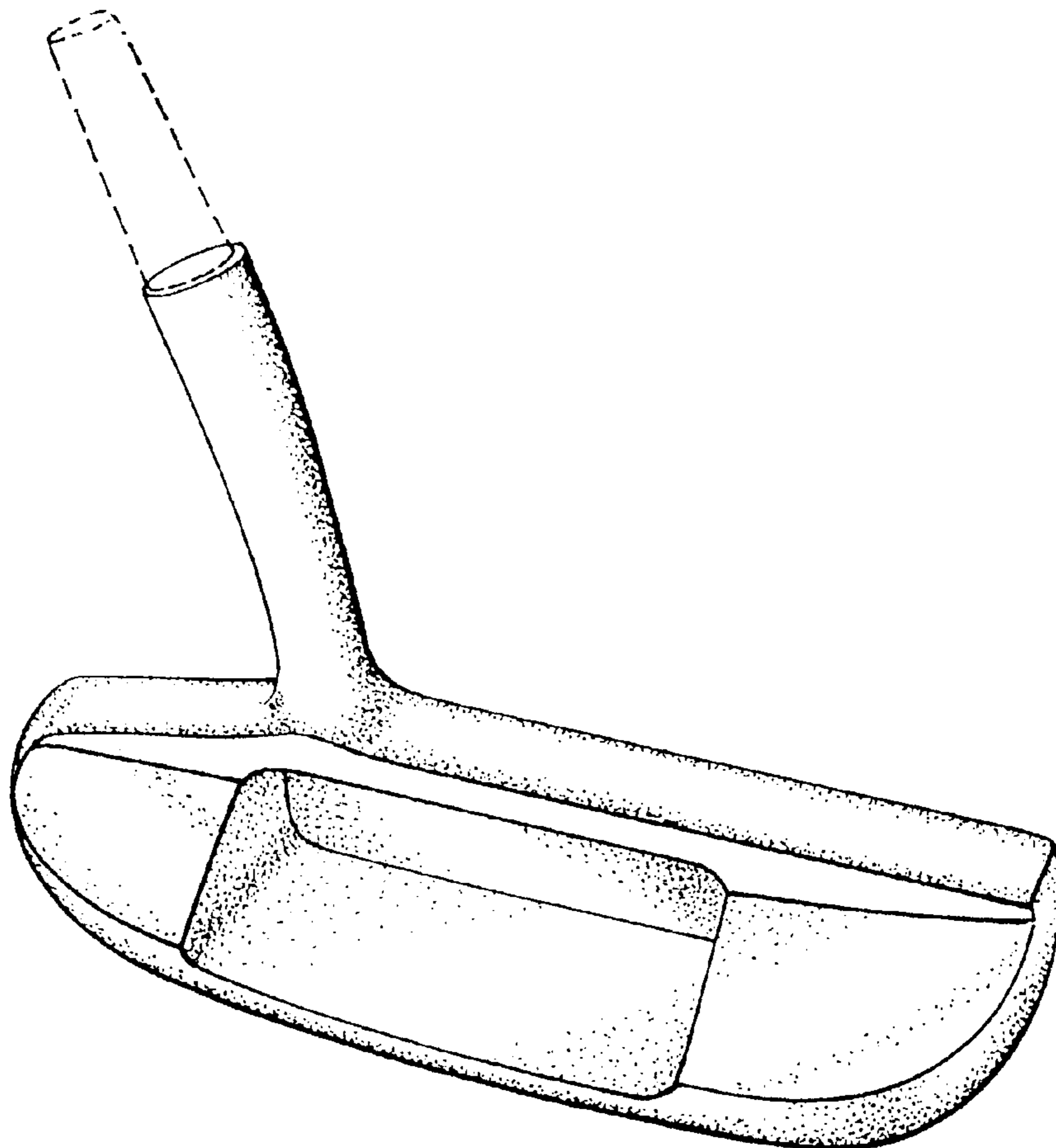
FIG. 6 is a toe side elevational view;

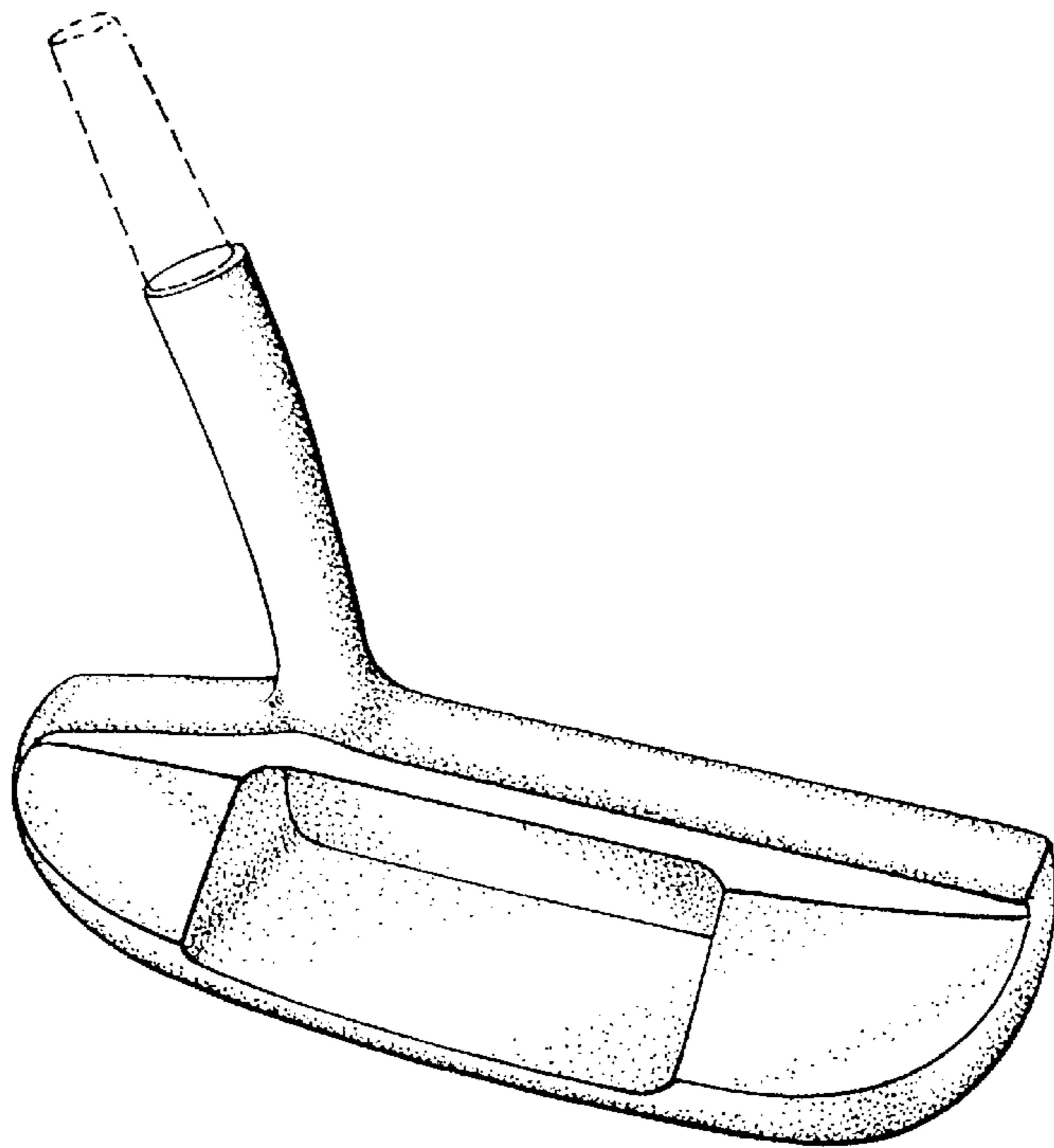
FIG. 7 is a front elevational view; the broken lines illustrating the striking face is not part of the design; and,

FIG. 8 is a heel side elevational view.

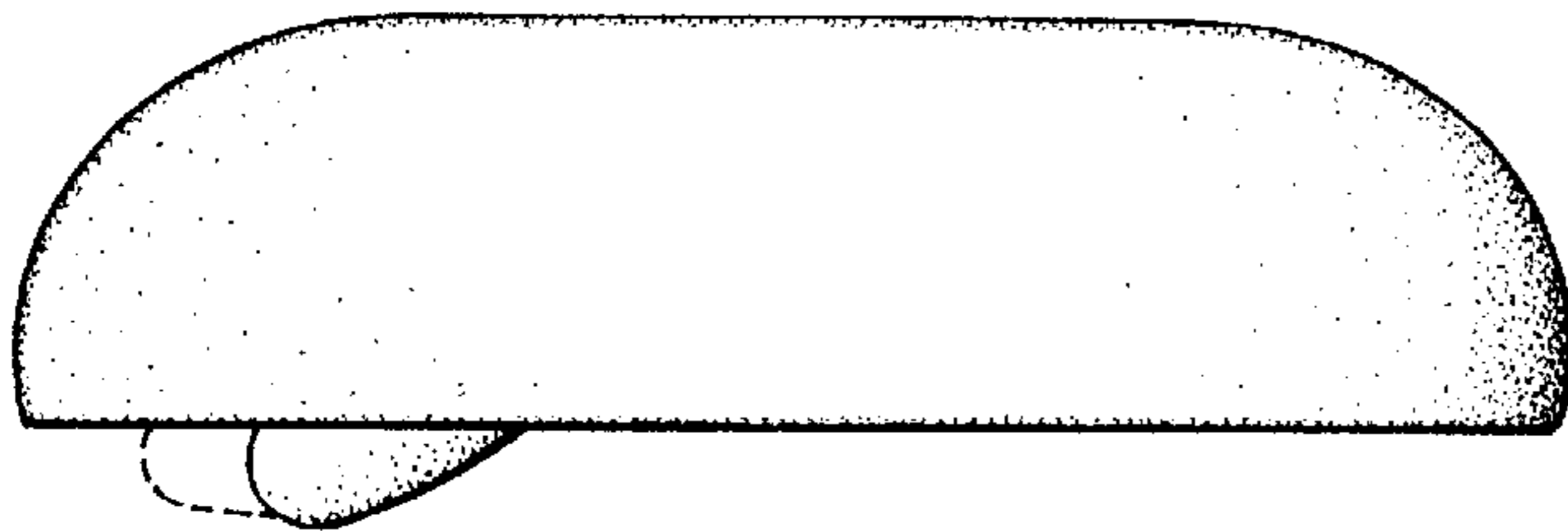
The broken line showing of a golf club shaft is for illustrative purposes only and forms no part of the claimed design.

**1 Claim, 2 Drawing Sheets**

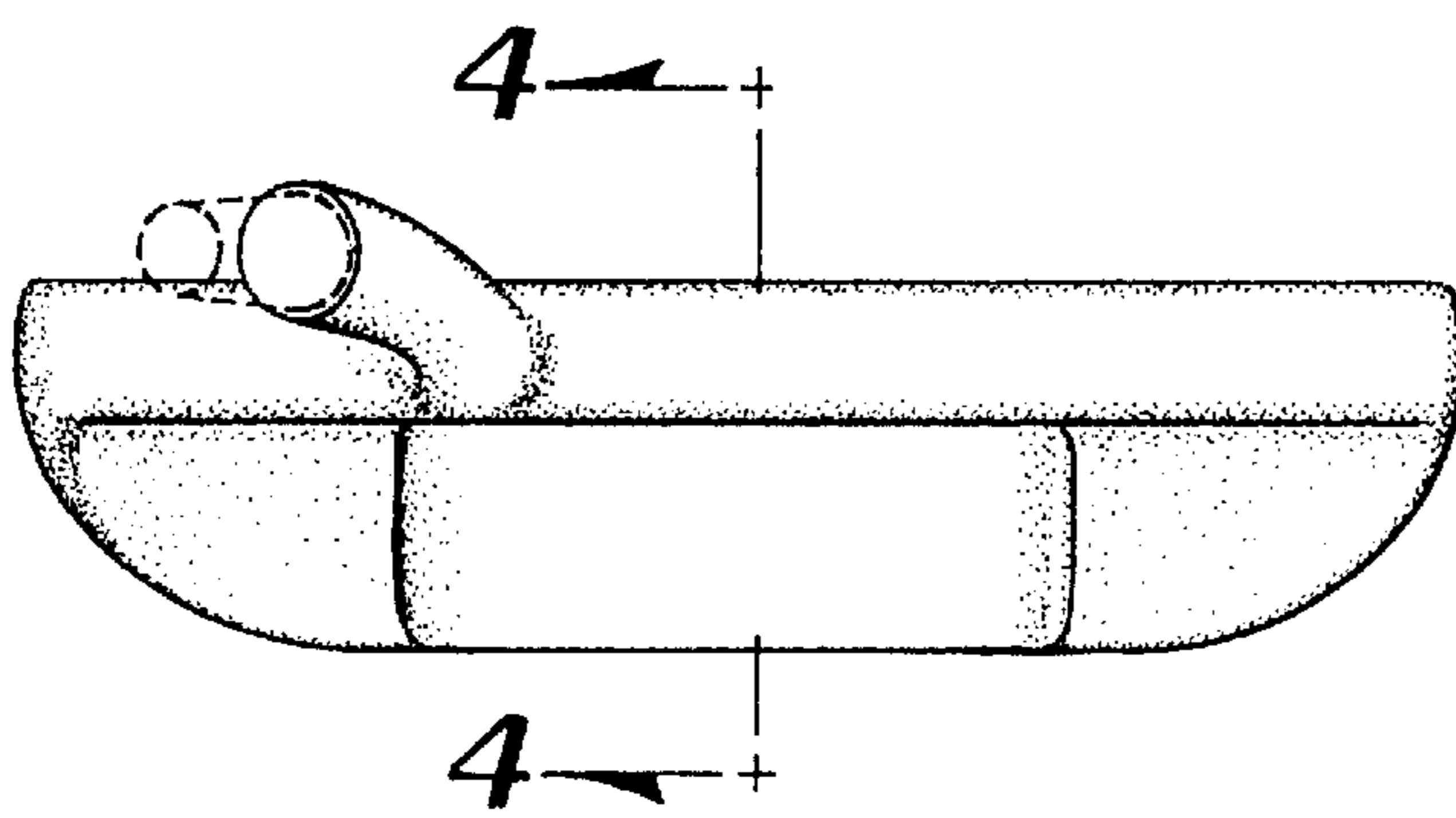




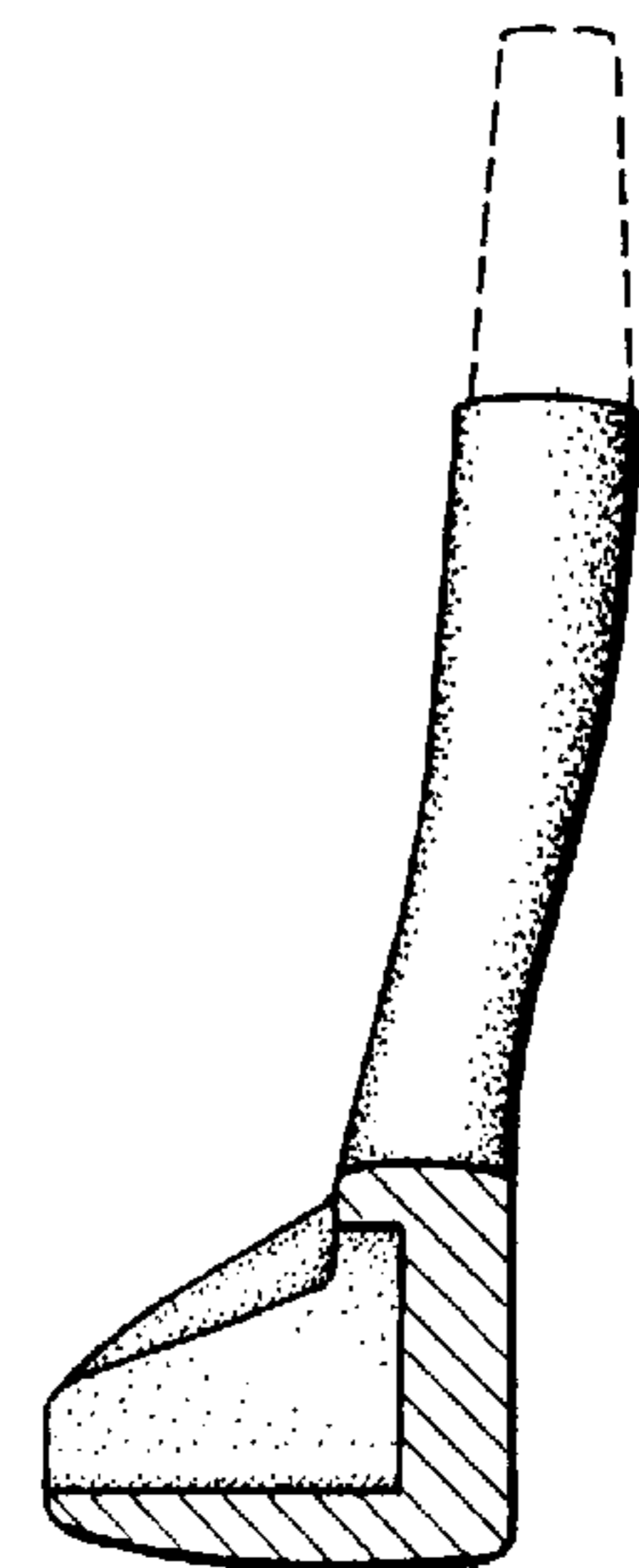
**FIG 1**



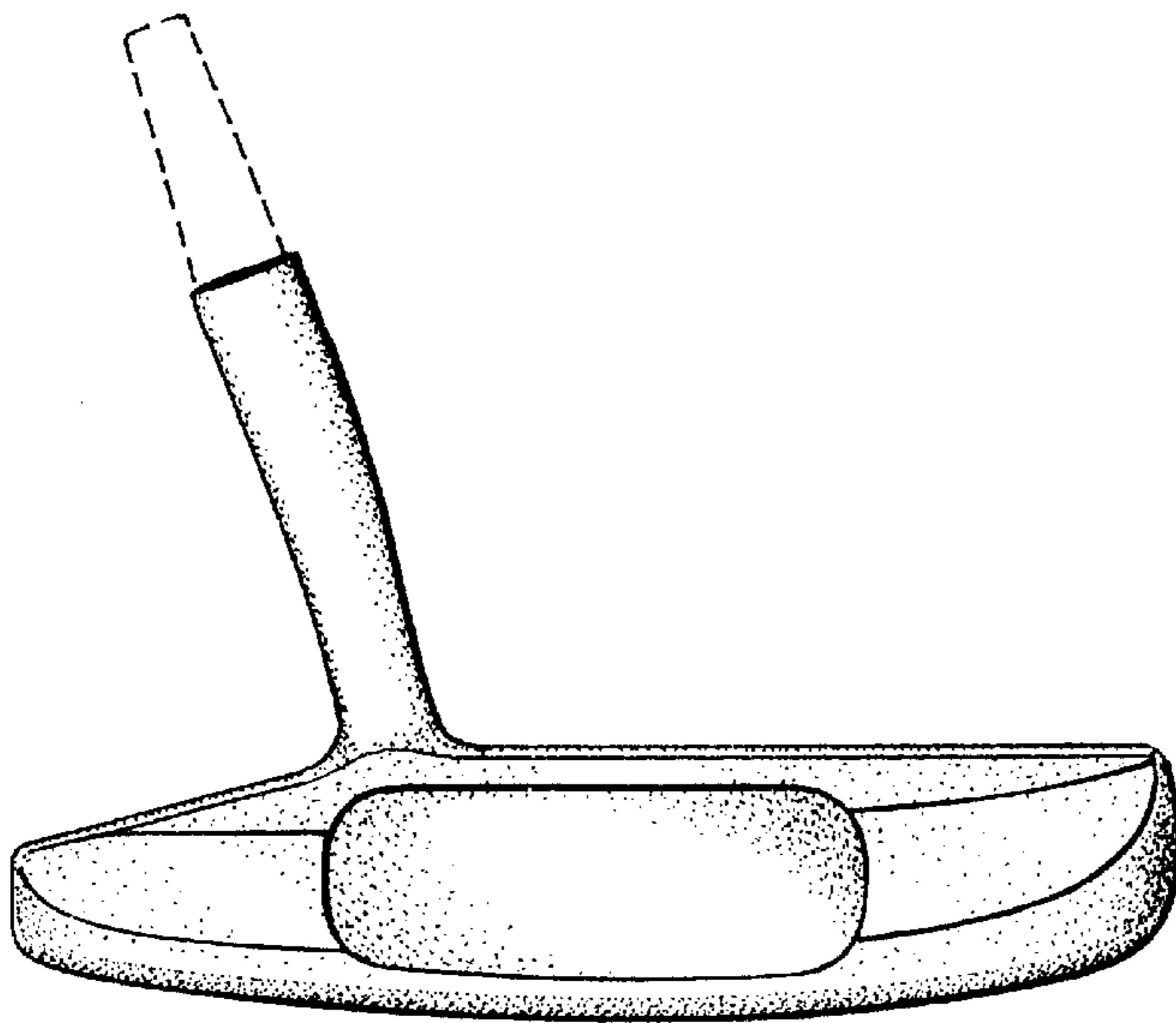
**FIG 2**



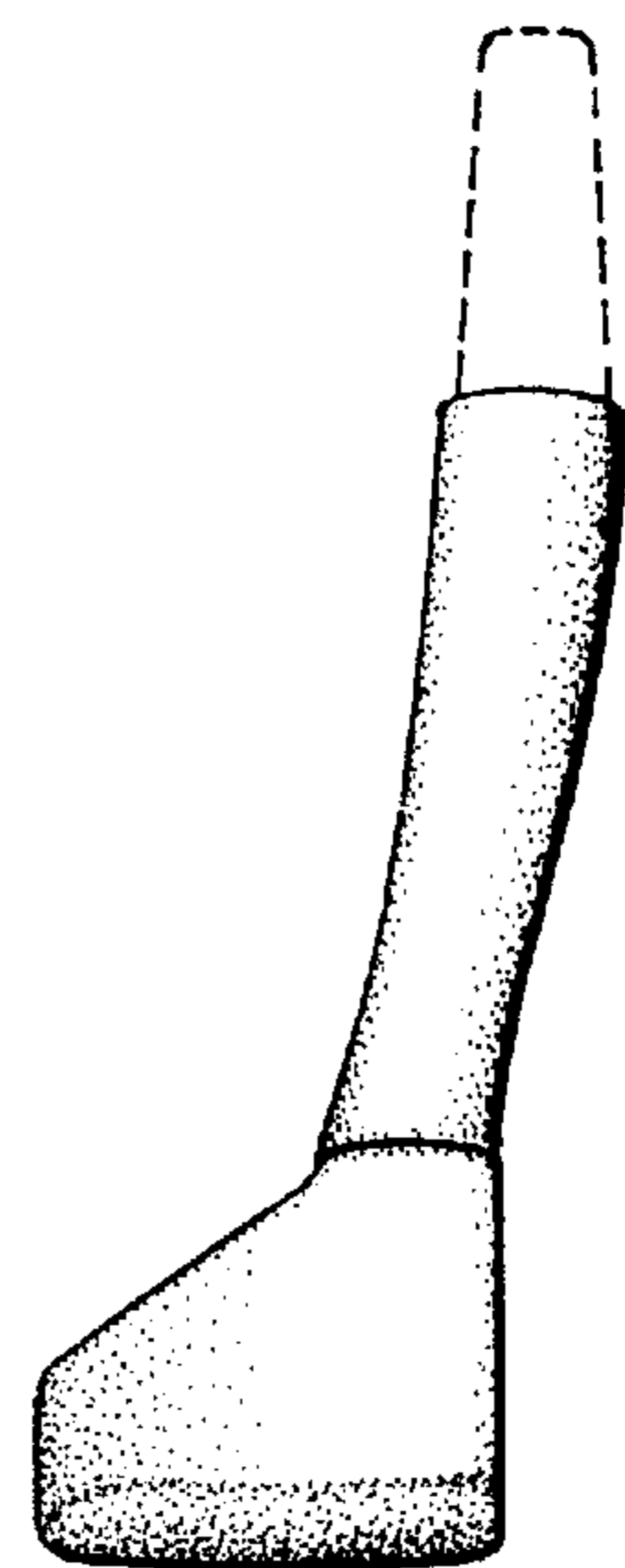
**FIG 3**



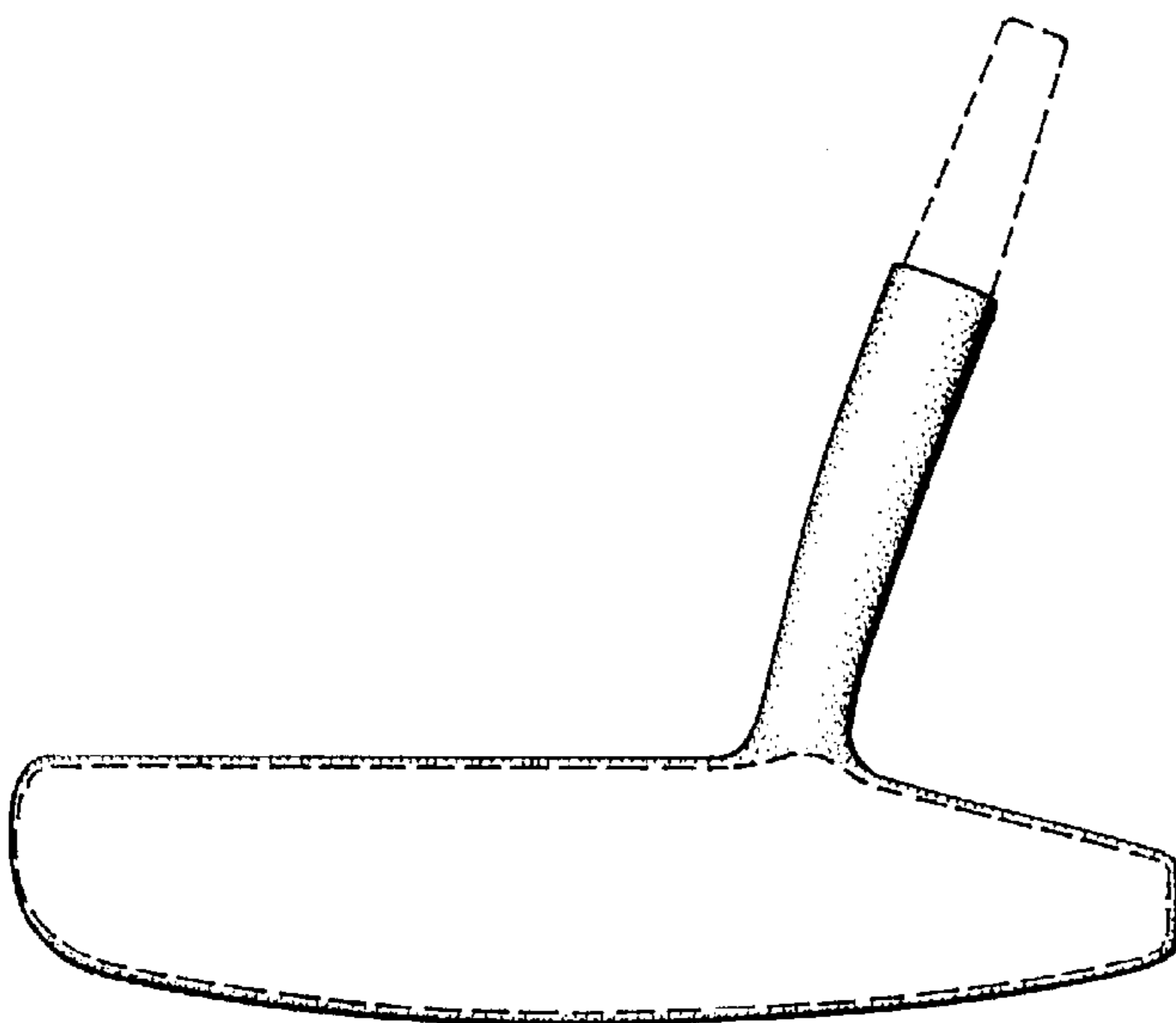
**FIG 4**



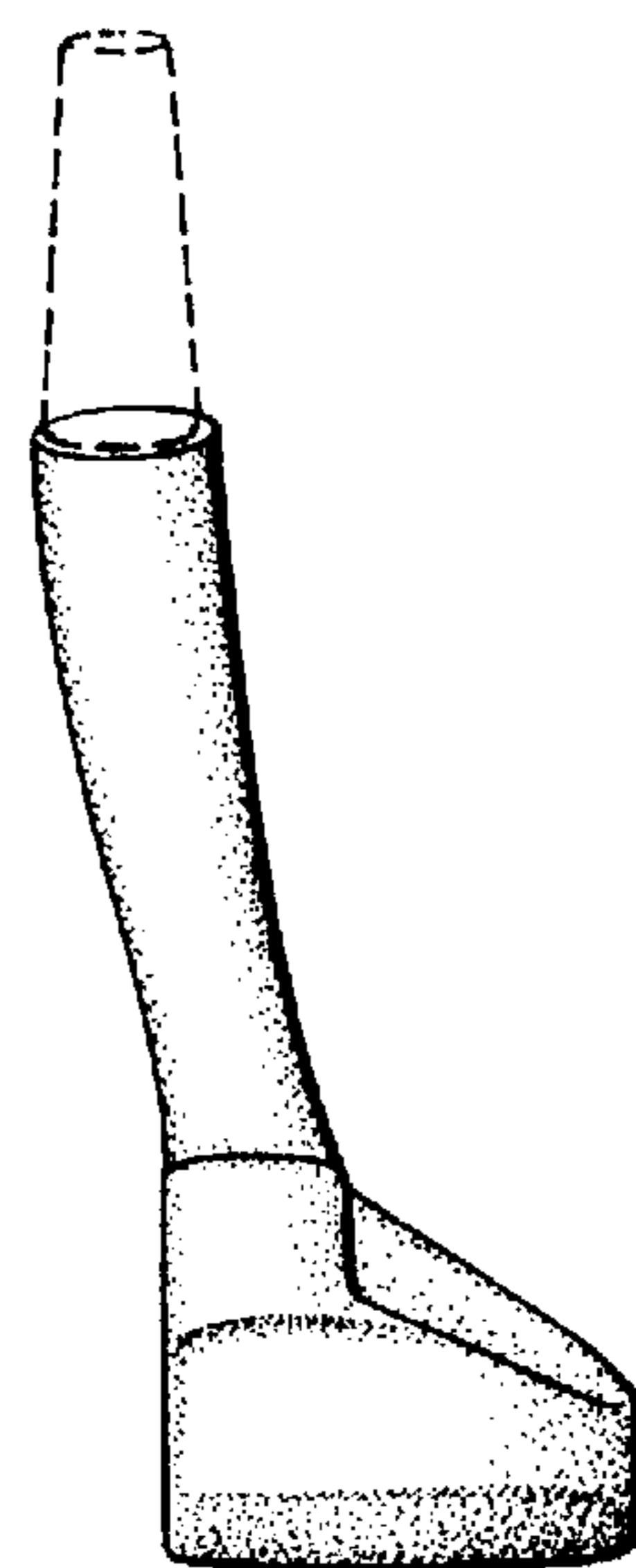
**FIG 5**



**FIG 6**



**FIG 7**



**FIG 8**