



US00D455791S

(12) **United States Design Patent**
Nakahara et al.

(10) **Patent No.:** **US D455,791 S**

(45) **Date of Patent:** **** Apr. 16, 2002**

(54) **GAME MACHINE**

(75) Inventors: **Takahiro Nakahara**, Kasukabe;
Takumi Kikuya, Kanagawa; **Hachitaro Sato**, Hino, all of (JP)

(73) Assignee: **Konami Co., Ltd.**, Tokyo (JP)

(**) Term: **14 Years**

(21) Appl. No.: **29/133,043**

(22) Filed: **Nov. 21, 2000**

(30) **Foreign Application Priority Data**

Jun. 9, 2000 (JP) 2000-015747

(51) **LOC (7) Cl.** **21-01**

(52) **U.S. Cl.** **D21/325**

(58) **Field of Search** D21/324-333,
D21/344, 350, 385; 463/1, 9, 14, 15, 30-35,
46-50; 273/148 B, 237, 239, 259, 283;
446/417; 472/62

(56) **References Cited**

U.S. PATENT DOCUMENTS

4,643,421 A * 2/1987 Meyer et al. 463/1

4,695,903 A * 9/1987 Serap et al. 463/46
4,850,591 A * 7/1989 Takezawa et al. 463/2
5,299,810 A * 4/1994 Pierce et al. 463/2
5,857,910 A * 1/1999 Watanabe et al. 463/46
D421,774 S * 3/2000 Toriyama D21/325
D435,271 S * 12/2000 Muraki et al. D21/325
D444,506 S * 7/2001 Isetani et al. D21/325

* cited by examiner

Primary Examiner—Prabhakar Deshmukh

(74) *Attorney, Agent, or Firm*—Jordan and Hamburg LLP

(57) **CLAIM**

The ornamental design for a game machine, as shown and described.

DESCRIPTION

FIG. 1 is a perspective view of a game machine;
FIG. 2 is a front view thereof;
FIG. 3 is a rear view thereof;
FIG. 4 is a left side view thereof;
FIG. 5 is a right side view thereof;
FIG. 6 is a top view thereof; and,
FIG. 7 is a bottom view thereof.

1 Claim, 7 Drawing Sheets

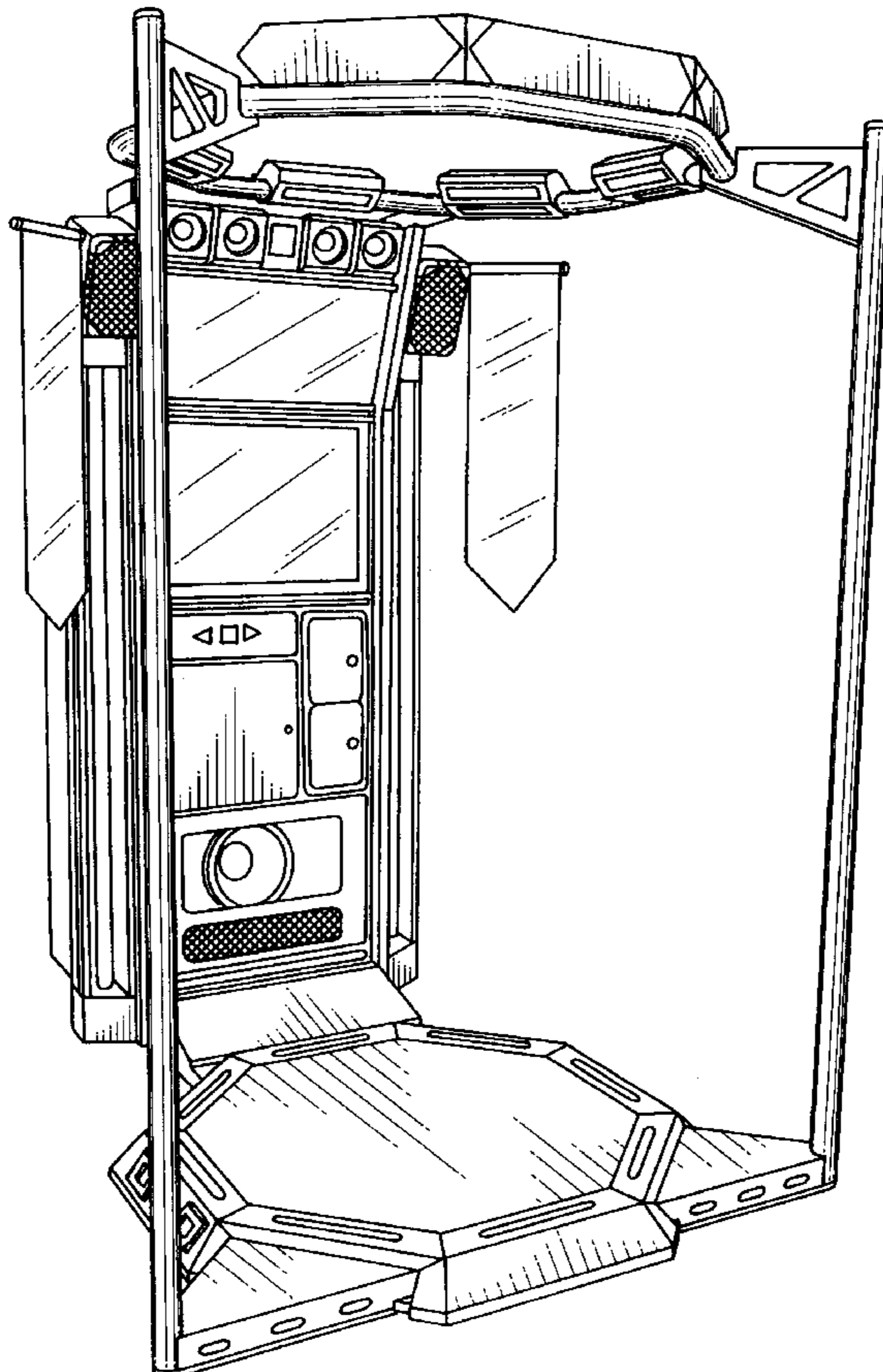

FIG. 1

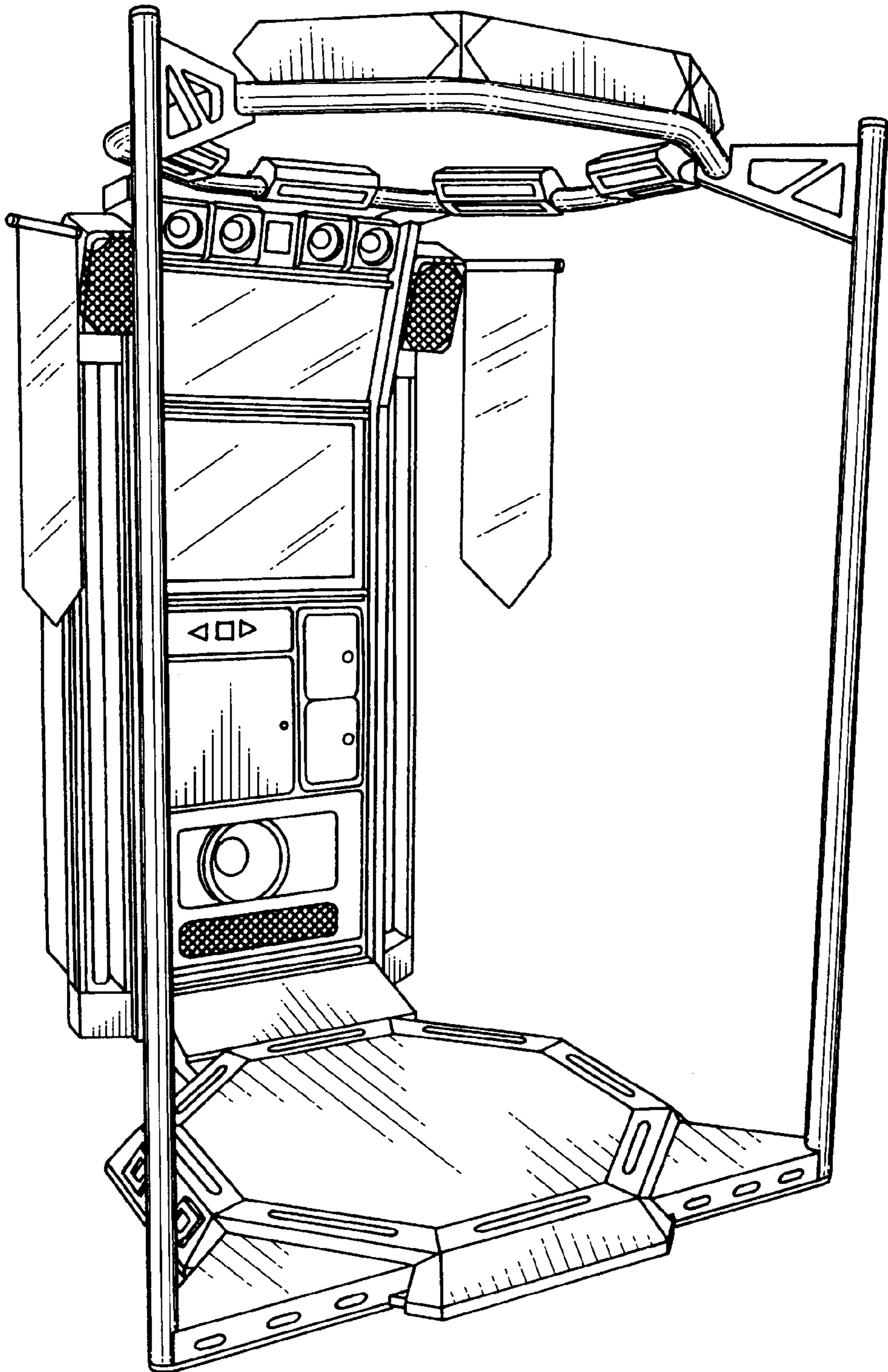

FIG. 2

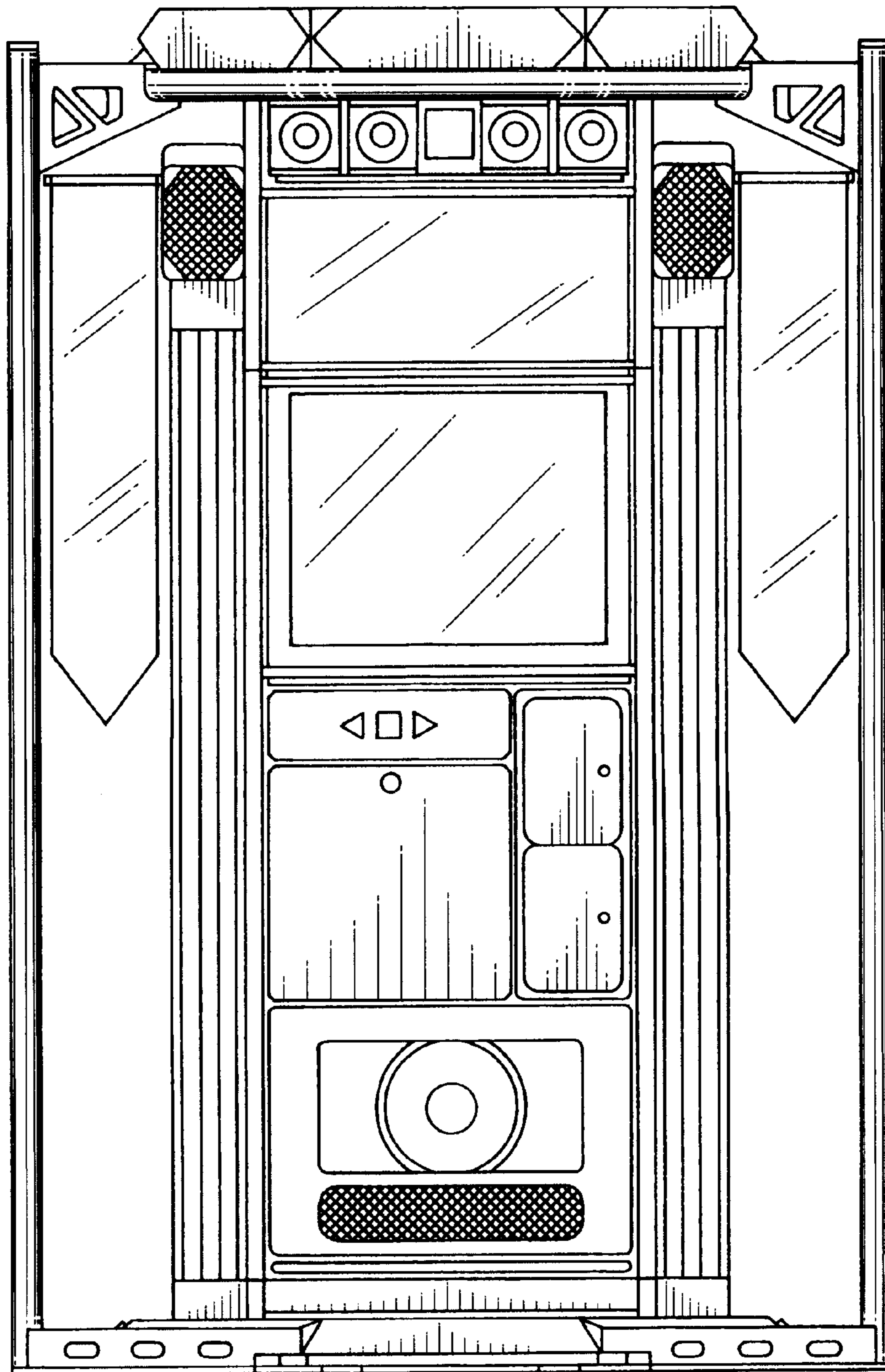

FIG. 3

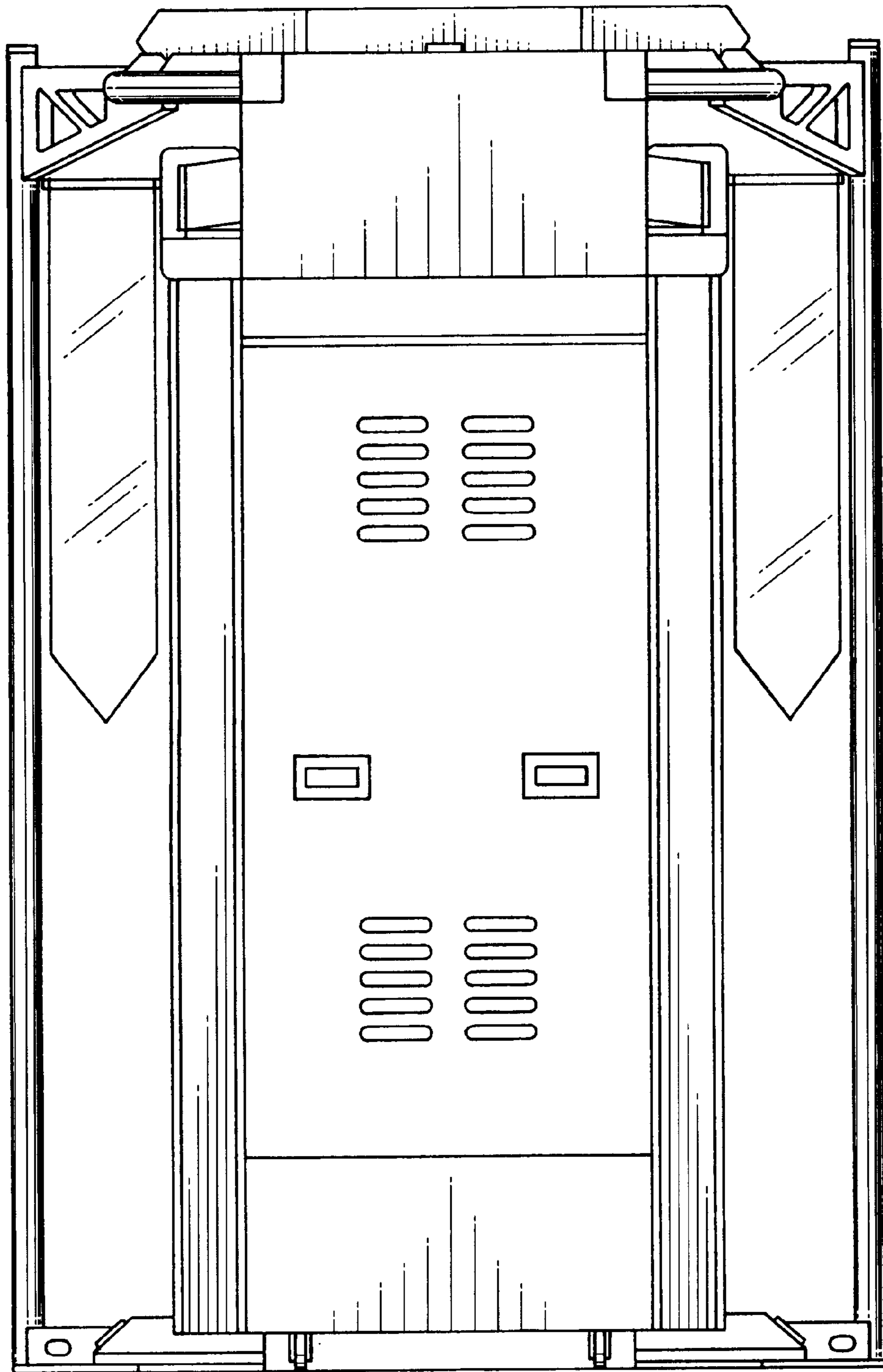

FIG. 4

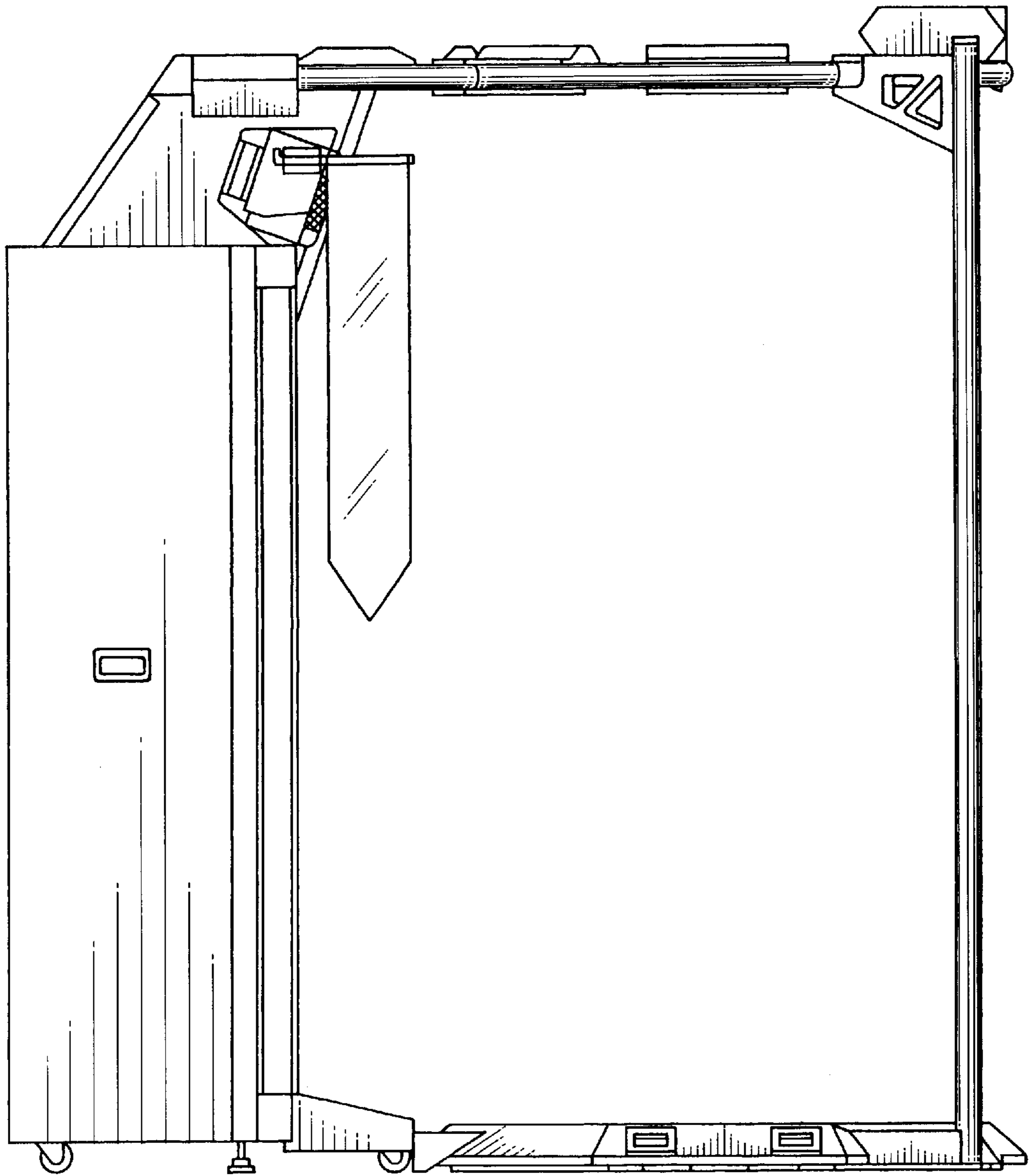

FIG. 5

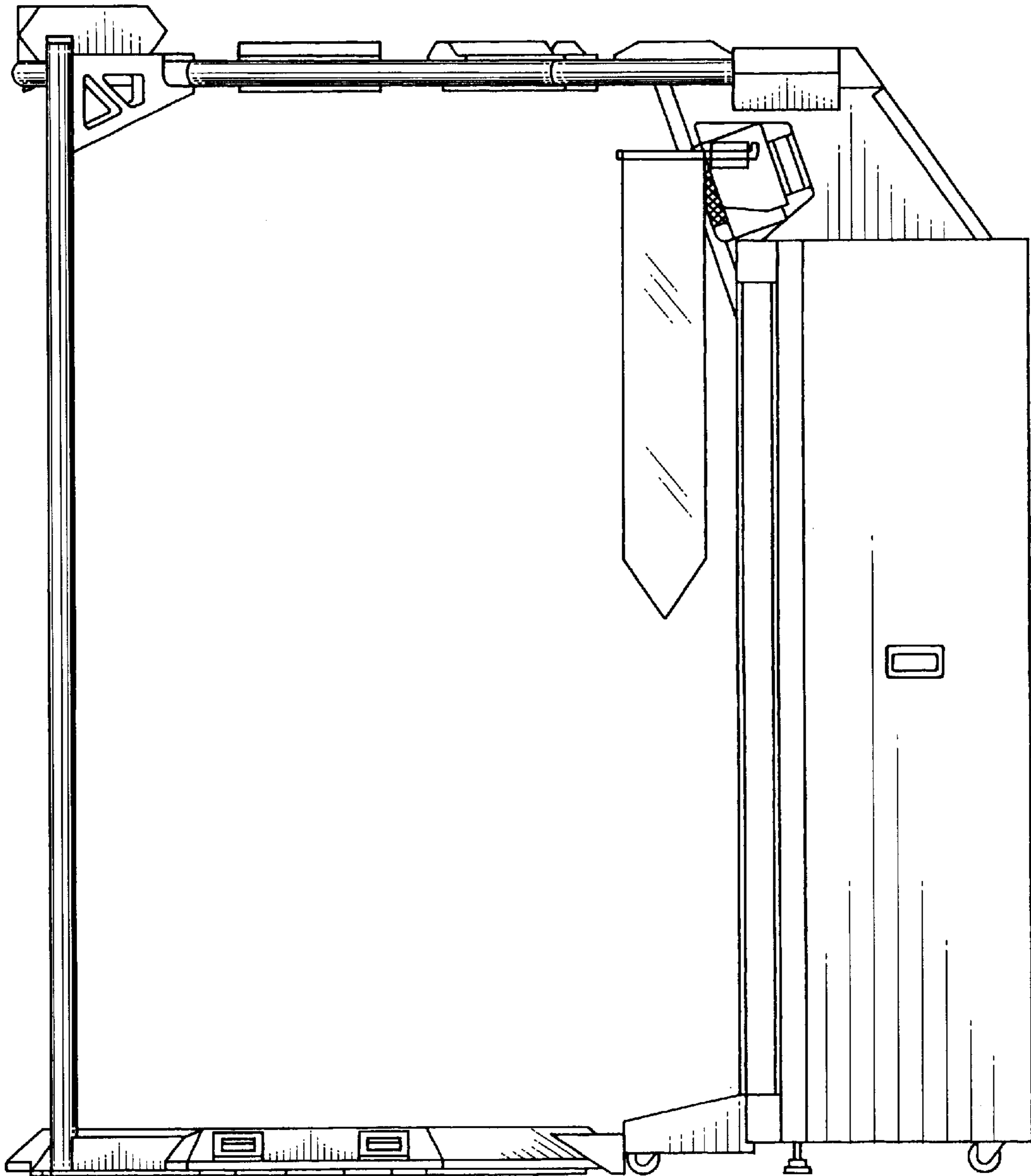

FIG. 6

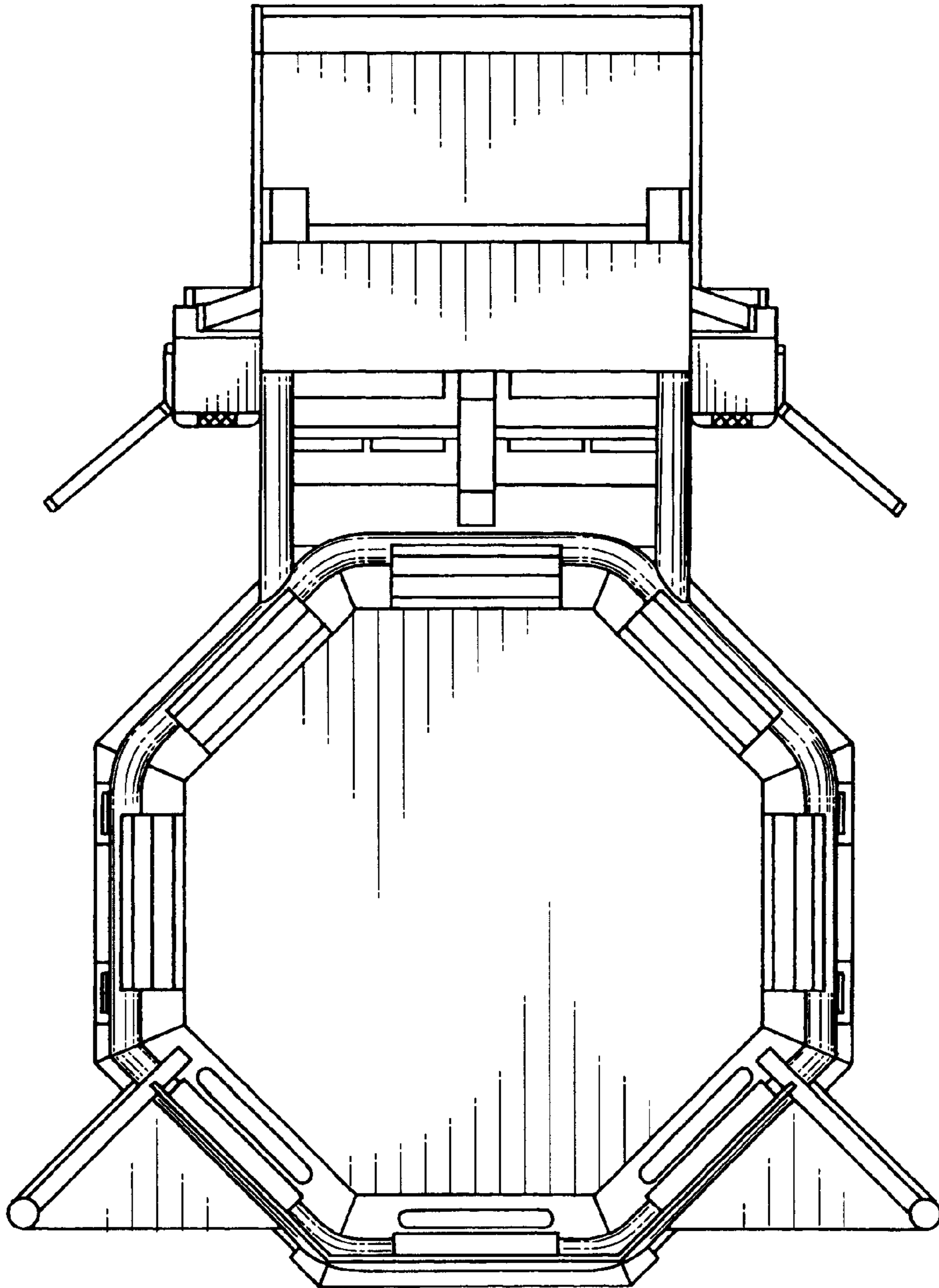

FIG. 7

