



US00D455778S

(12) **United States Design Patent**
Katsuyama

(10) **Patent No.:** **US D455,778 S**

(45) **Date of Patent:** **** Apr. 16, 2002**

(54) **TONER CARTRIDGE**

(75) Inventor: **Goro Katsuyama**, Yokohama (JP)

(73) Assignee: **Ricoh Company, Ltd.**, Tokyo (JP)

(**) Term: **14 Years**

(21) Appl. No.: **29/132,016**

(22) Filed: **Nov. 1, 2000**

(30) **Foreign Application Priority Data**

May 2, 2000 (JP) 2000-015621

(51) **LOC (7) Cl.** **16-03**

(52) **U.S. Cl.** **D18/43**

(58) **Field of Search** D18/40, 43, 56;
399/24-27, 252, 262; 222/DIG. 1

(56) **References Cited**

U.S. PATENT DOCUMENTS

- 4,599,851 A * 7/1986 Williams 53/471
- D307,767 S * 5/1990 Tsumuro D18/43
- 5,089,854 A * 2/1992 Kaieda et al. 399/262
- 5,091,750 A * 2/1992 Yoshida et al. 399/106

- D366,278 S * 1/1996 Nagashima D18/43
- D394,451 S * 5/1998 Okada D18/43
- D395,914 S * 7/1998 Yoshino et al. D18/43
- D400,915 S * 11/1998 Nomura et al. D18/40
- D431,593 S * 10/2000 Gumbe D18/40

* cited by examiner

Primary Examiner—Caron D. Veynar

(74) *Attorney, Agent, or Firm*—Dickstein Shapiro Morin & Oshinsky LLP

(57) **CLAIM**

The ornamental design for a toner cartridge, as shown and described.

DESCRIPTION

FIG. 1 is a front elevation of a toner cartridge according to the present invention;
 FIG. 2 is a top plan view thereof;
 FIG. 3 is a rear elevation thereof;
 FIG. 4 is a bottom plan view thereof;
 FIG. 5 is a right side elevation thereof,
 FIG. 6 is a left side elevation thereof; and,
 FIG. 7 is a top, front, and right side perspective view thereof.

1 Claim, 4 Drawing Sheets

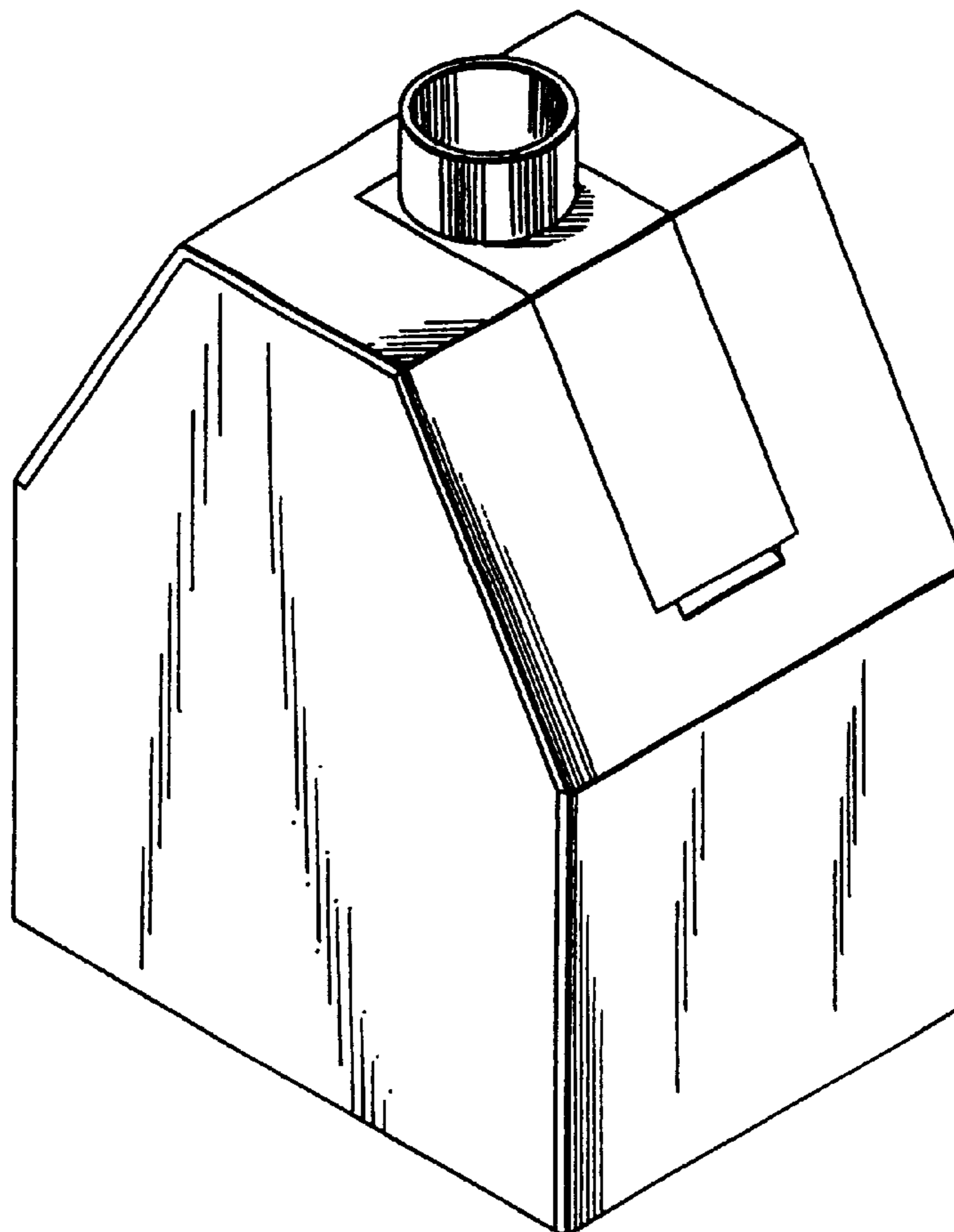

FIG. 1

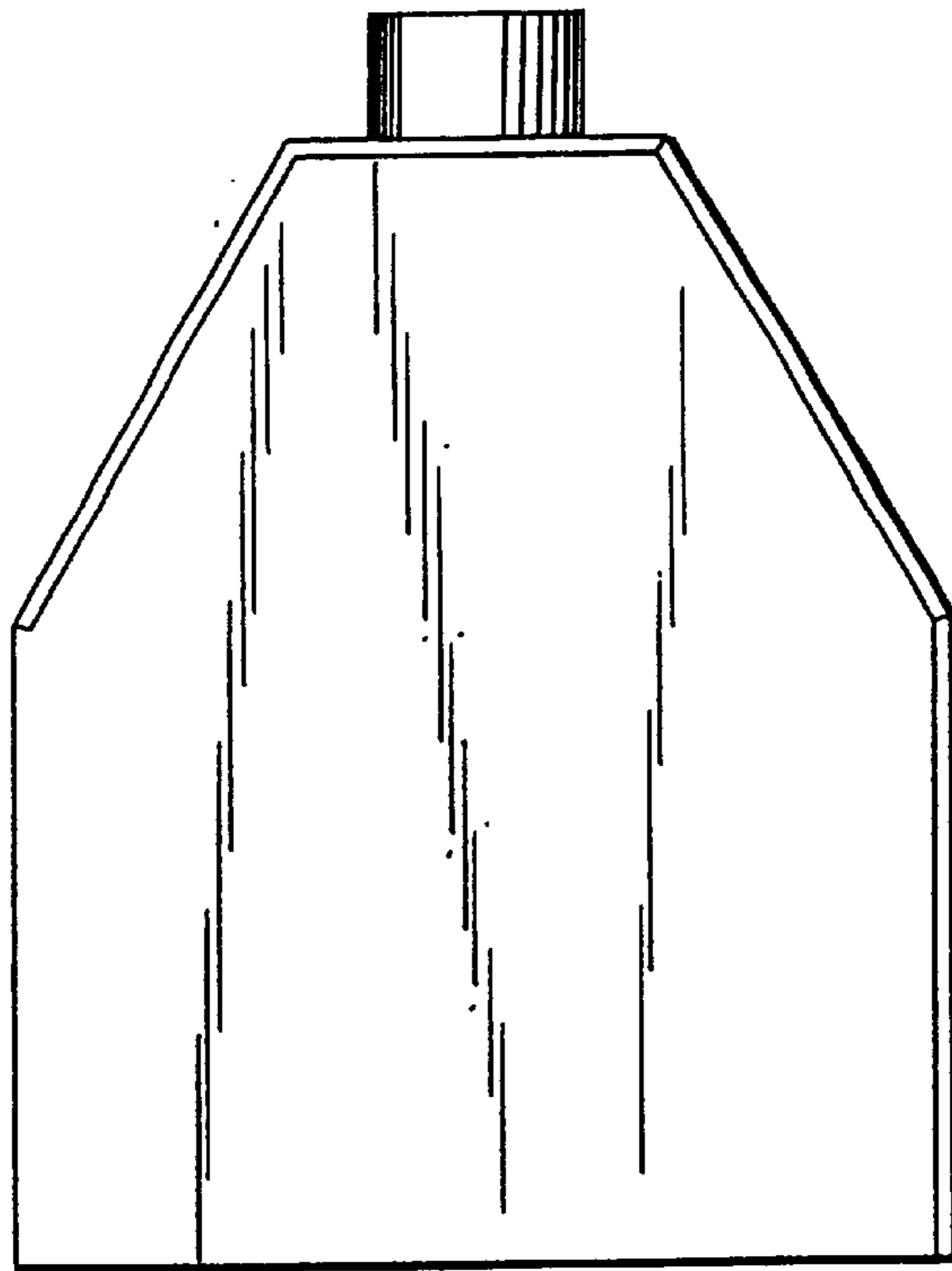

FIG. 2

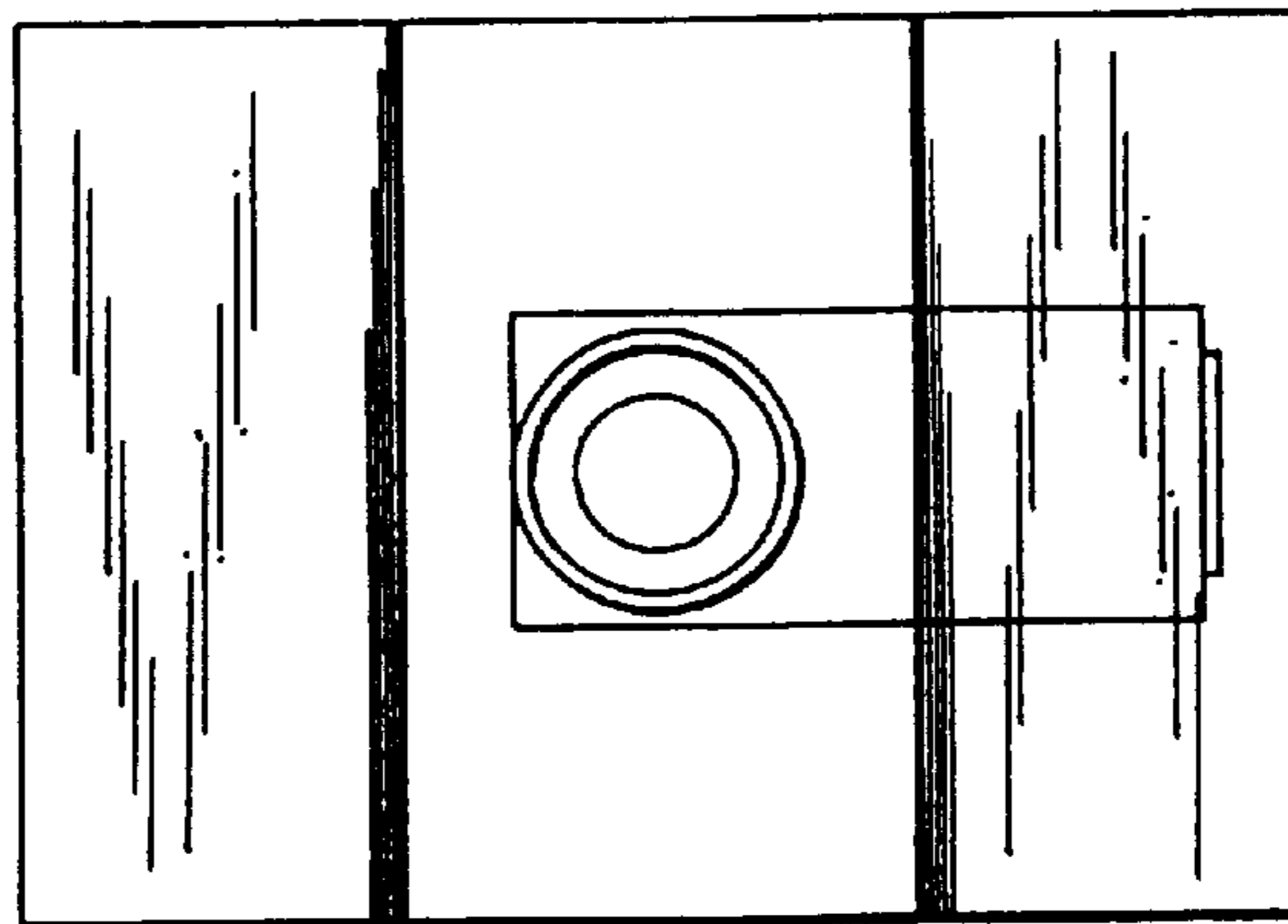

FIG. 3

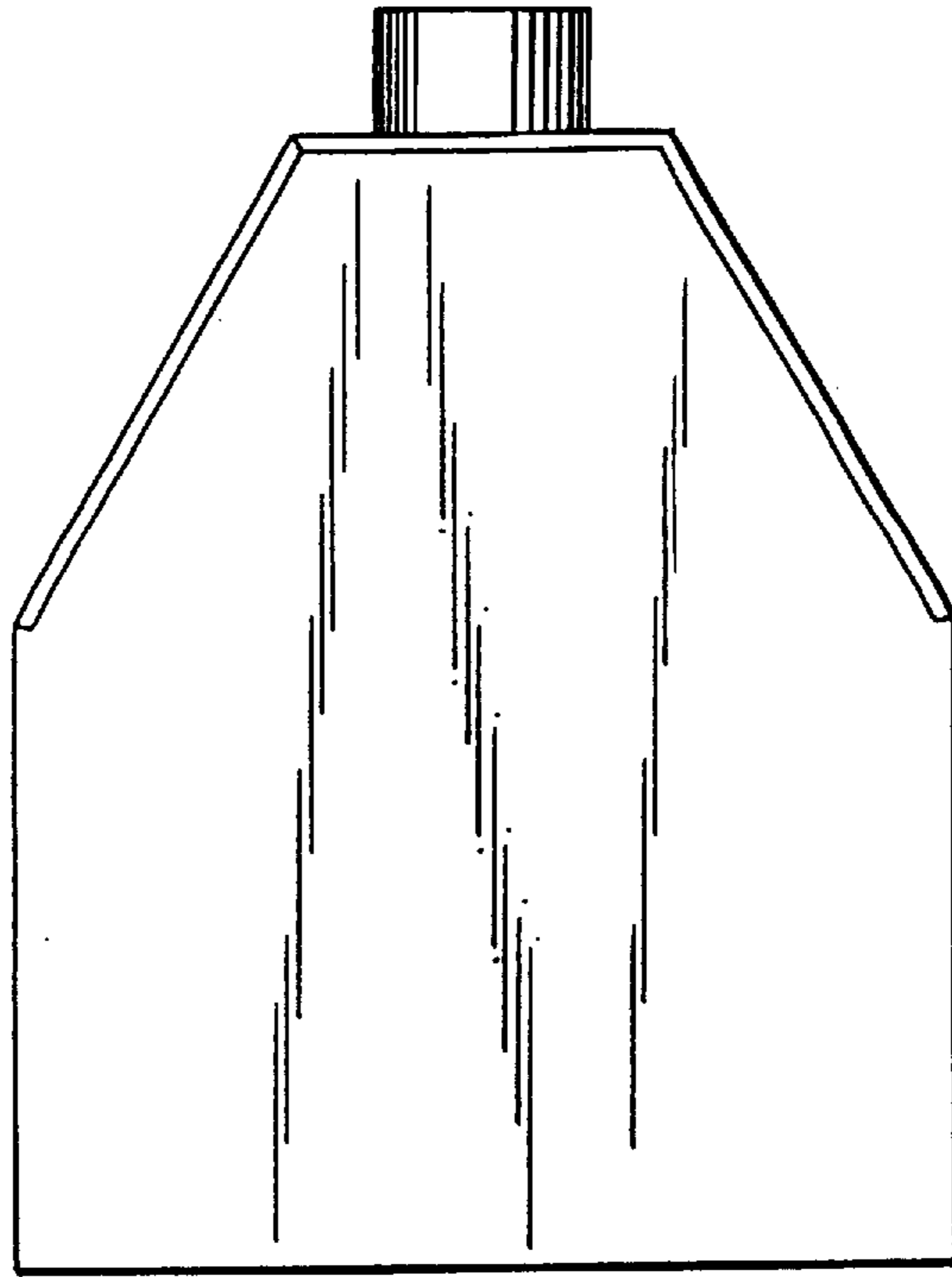

FIG. 4

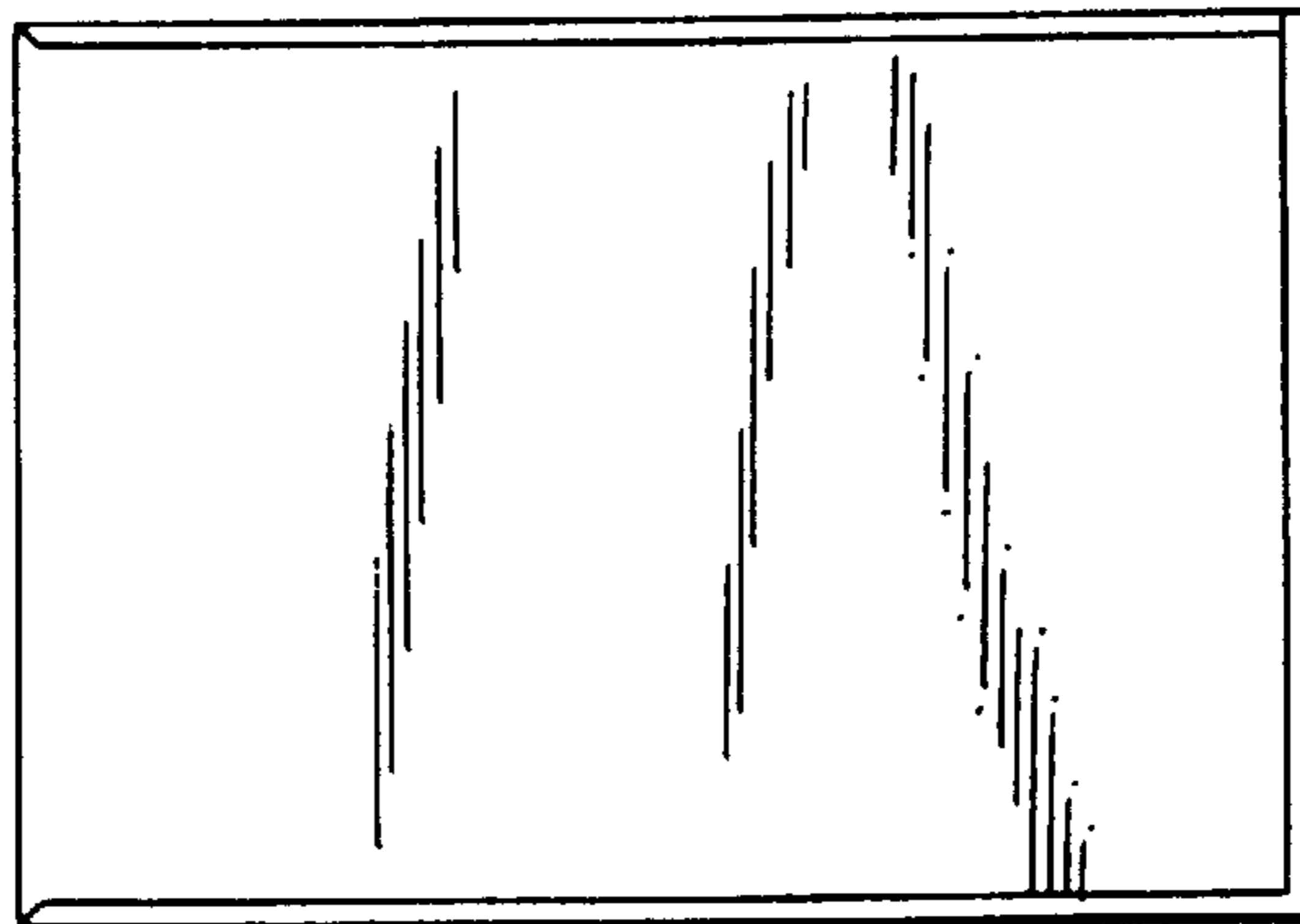

FIG. 5

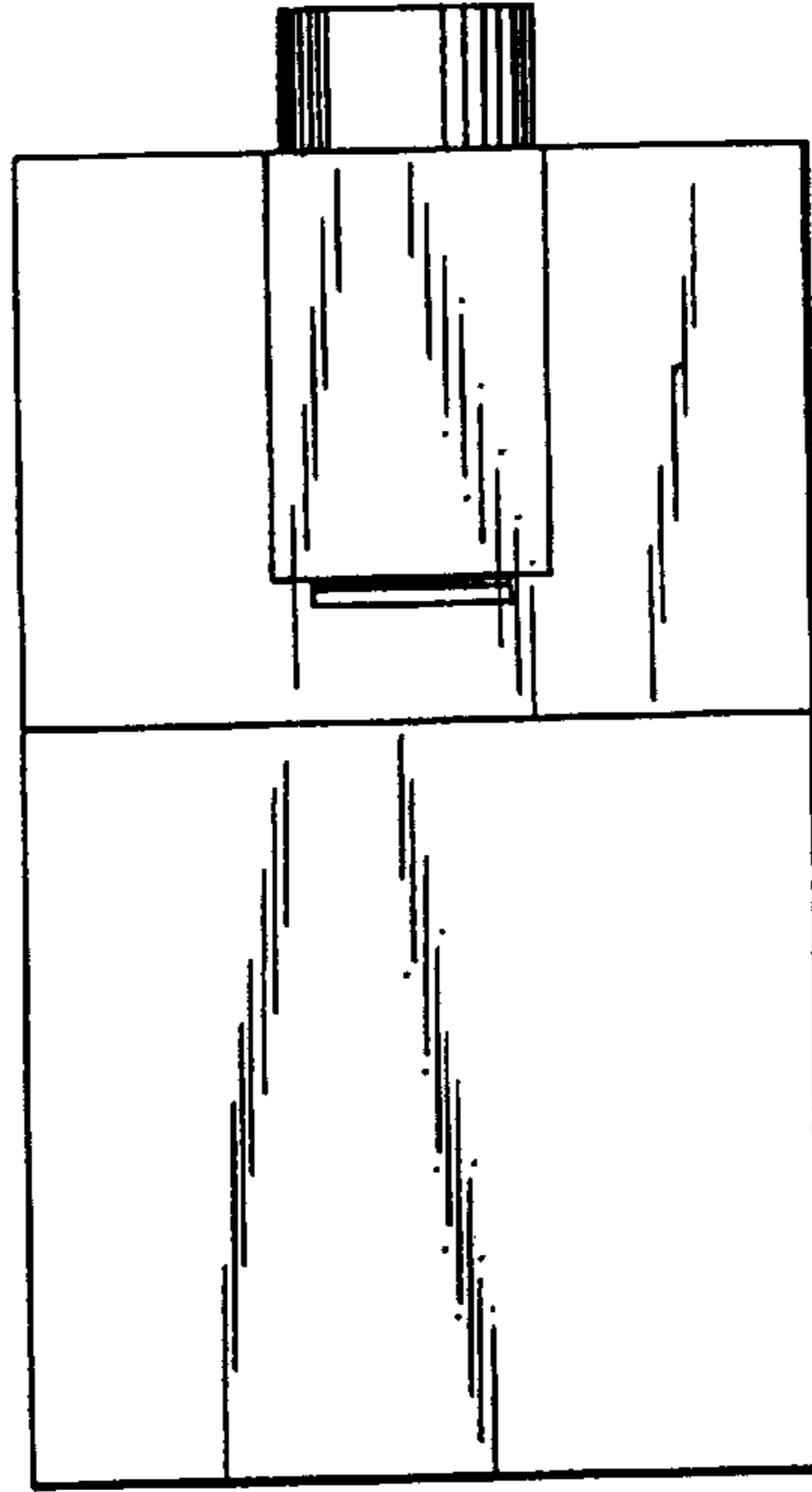

FIG. 6

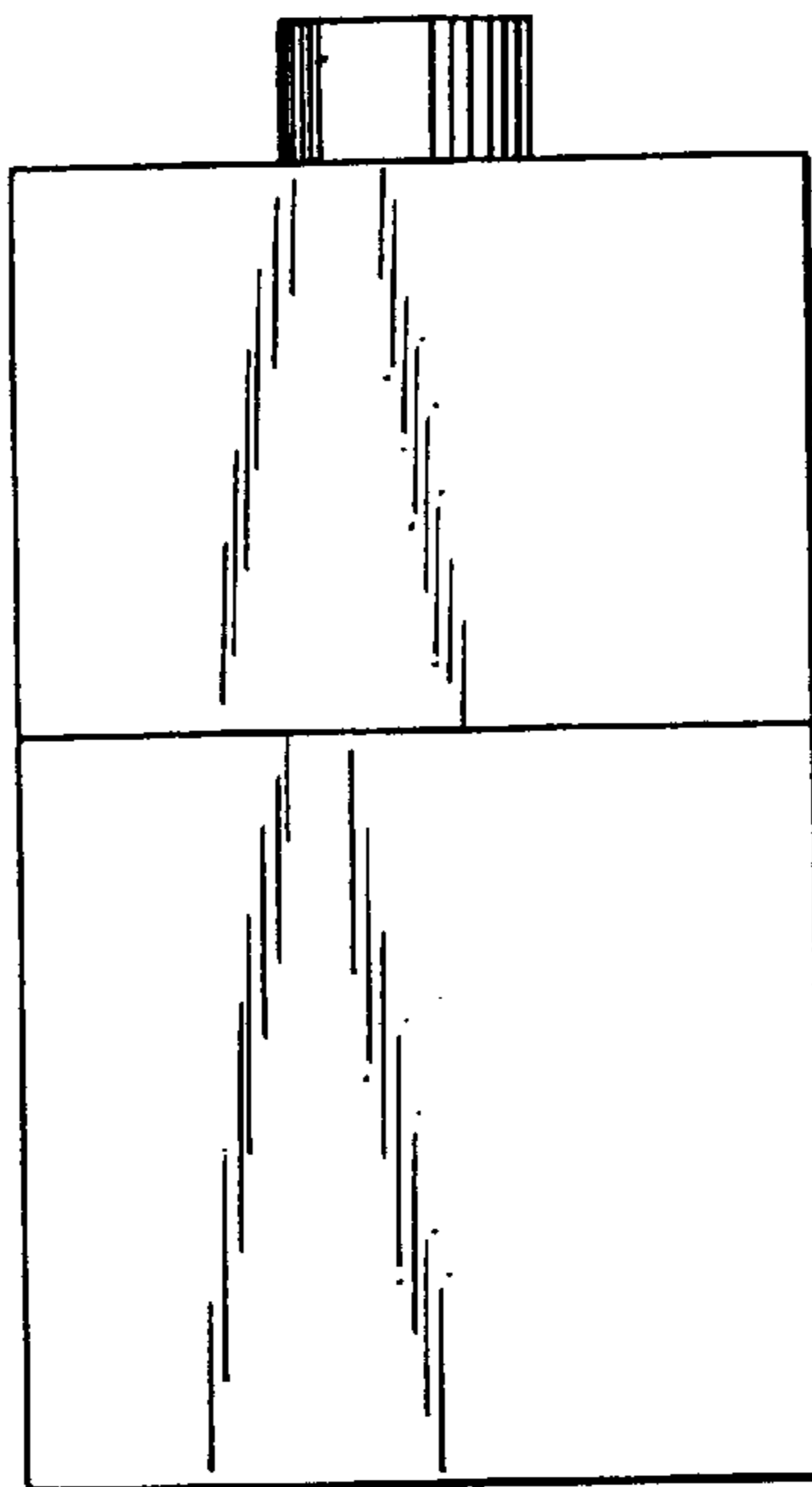

FIG. 7

