



US00D455745S

(12) **United States Design Patent**
Kim

(10) **Patent No.:** **US D455,745 S**

(45) **Date of Patent:** **** Apr. 16, 2002**

(54) **MULTIMEDIA COMPUTER**

(75) **Inventor:** **Yong-Nam Kim, Seongnam (KR)**

(73) **Assignee:** **UM Digital, Inc., Seoul (KR)**

(**) **Term:** **14 Years**

(21) **Appl. No.:** **29/142,081**

(22) **Filed:** **May 16, 2001**

(30) **Foreign Application Priority Data**

Nov. 17, 2000 (KR) 2000-29362

(51) **LOC (7) Cl.** **14-02**

(52) **U.S. Cl.** **D14/337**

(58) **Field of Search** D14/300, 301,
D14/314, 337, 336, 168, 172, 126-129,
305-307, 373, 331, 379; 345/104, 156,
168, 173; 348/180, 184, 325, 739; 341/12;
349/1, 2, 11, 62; 248/122.1

(56) **References Cited**

U.S. PATENT DOCUMENTS

D273,867 S	*	5/1984	Sanders et al.	D14/336
D360,193 S	*	7/1995	Franzen	D14/331
D369,790 S	*	5/1996	Kim	D14/379
D370,466 S	*	6/1996	Vossoughi	D14/336
D372,226 S	*	7/1996	Maguire, Jr.	D14/306
5,687,939 A	*	11/1997	Moscovitch	248/122.1

D397,324 S	*	8/1998	Minemoto et al.	D14/337
D424,530 S	*	5/2000	Kurtz et al.	D14/336
D431,547 S	*	10/2000	Mirone	D14/168
D433,008 S	*	10/2000	Pardo	D14/168

* cited by examiner

Primary Examiner—Freda Nunn

(74) *Attorney, Agent, or Firm*—Christie, Parker & Hale, LLP

(57) **CLAIM**

The ornamental design for the multimedia computer, as shown and described.

DESCRIPTION

FIG. 1 is a front elevational view of the design for a multimedia computer;
 FIG. 2 is a rear elevational view of the design of FIG. 1;
 FIG. 3 is a left side elevational view of the design of FIG. 1;
 FIG. 4 is a right side elevational view of the design of FIG. 1;
 FIG. 5 is a top plan view of the design of FIG. 1;
 FIG. 6 is a bottom plan view of the design of FIG. 1; and,
 FIG. 7 is a top, front, left side perspective view of the design of FIG. 1.

The surface(s) or portion(s) of the article not shown in the drawing or described in the specification form(s) no part of the claimed design.

1 Claim, 4 Drawing Sheets

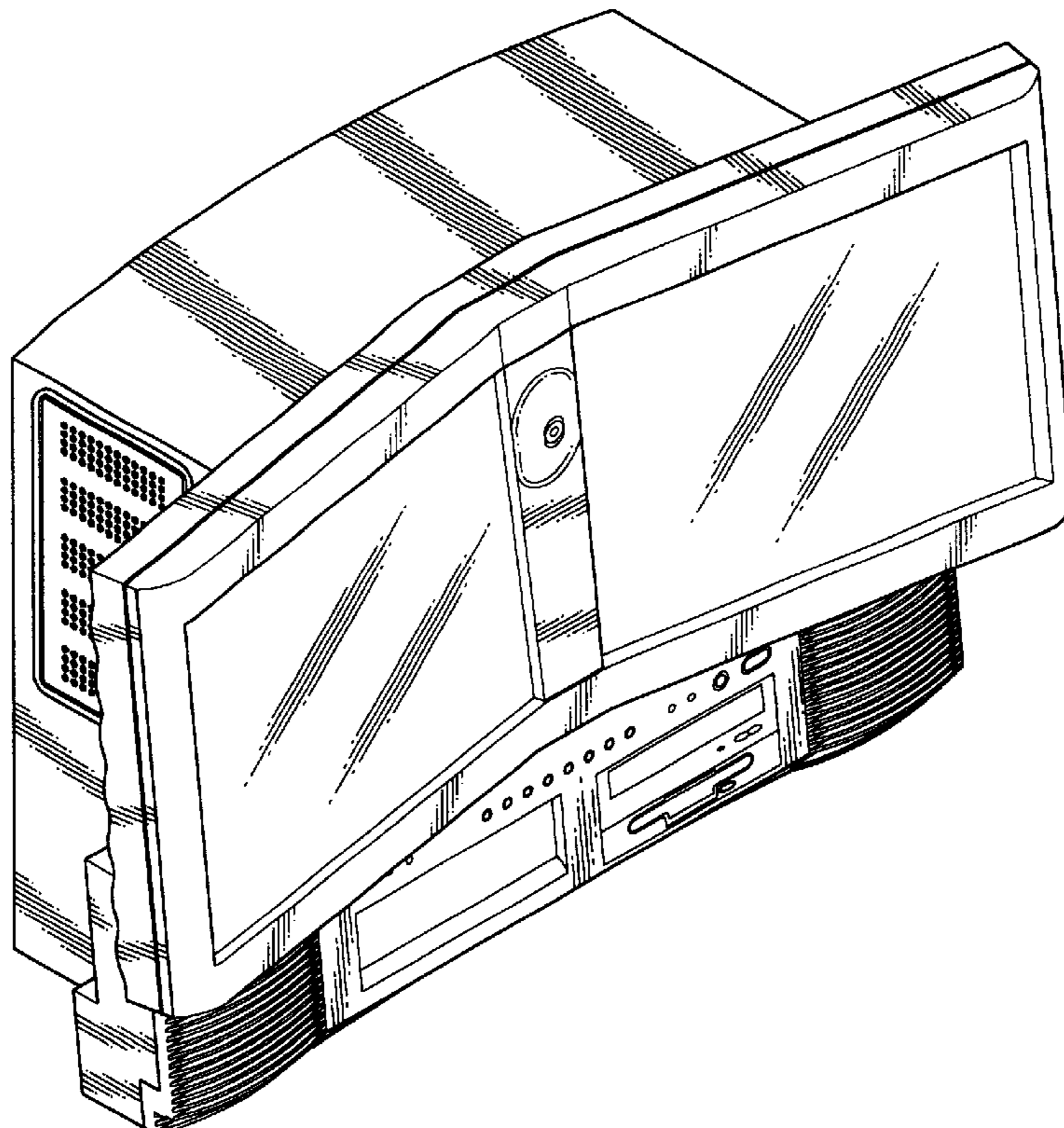

FIG.1

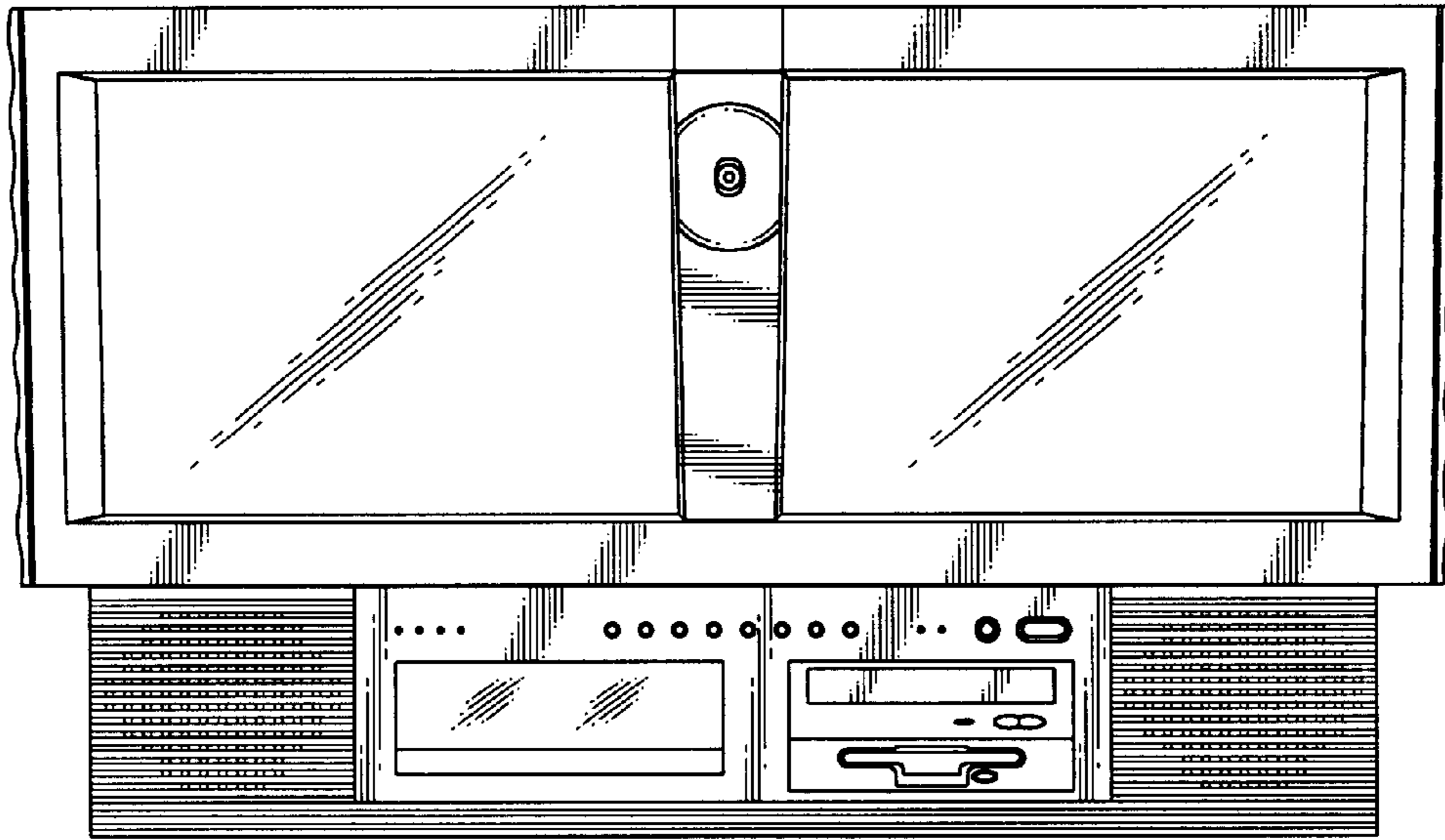

FIG.2

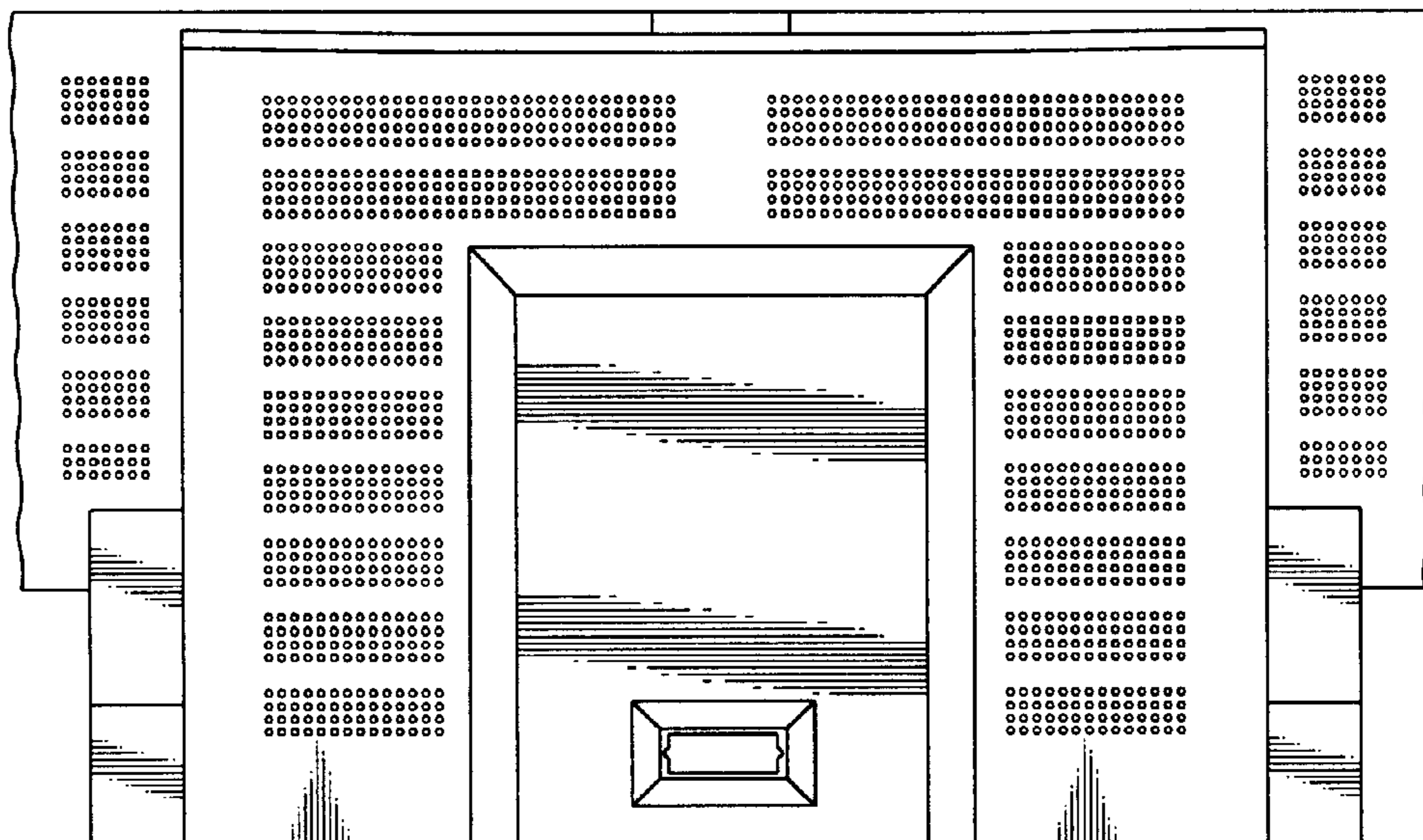

FIG.3

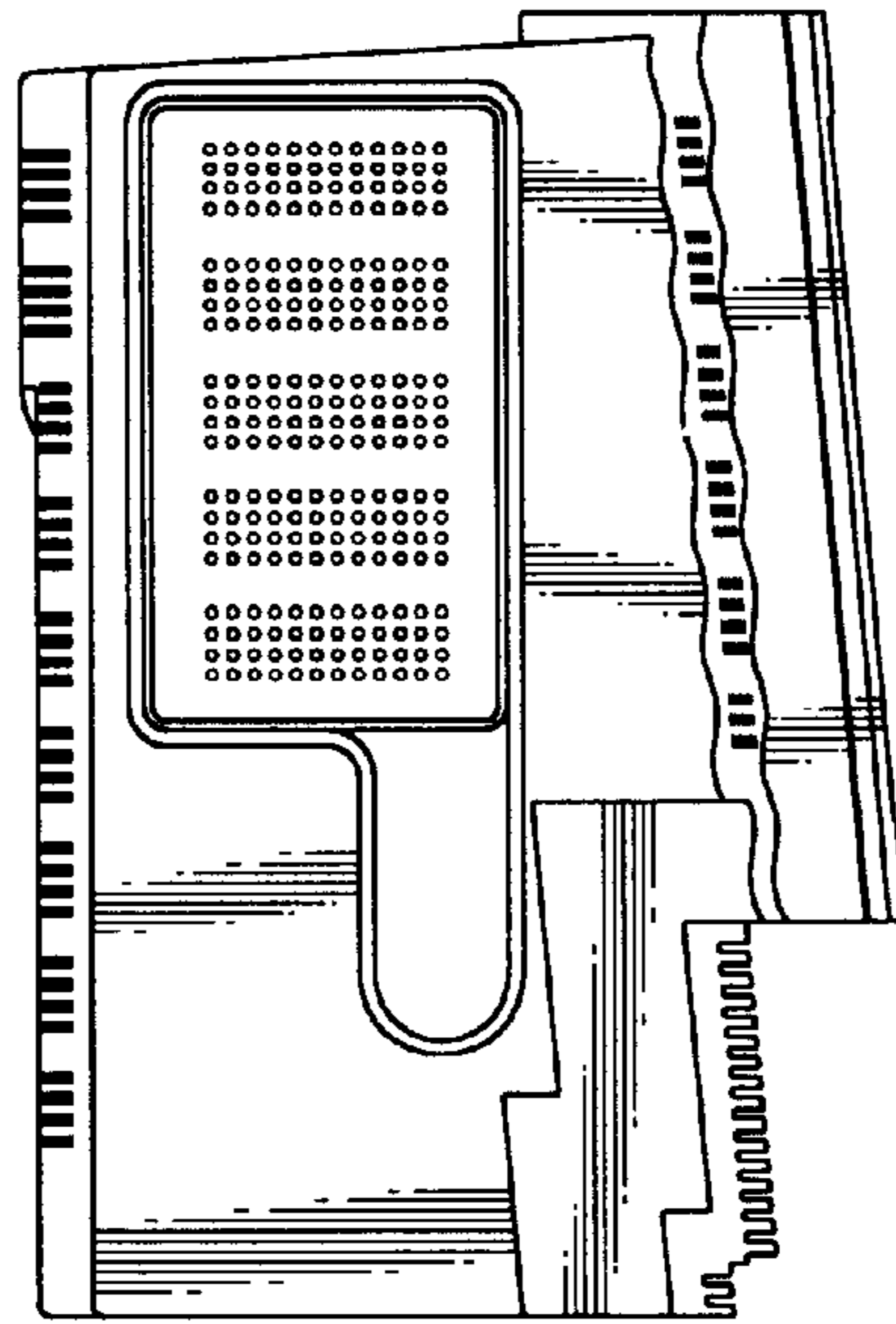

FIG.4

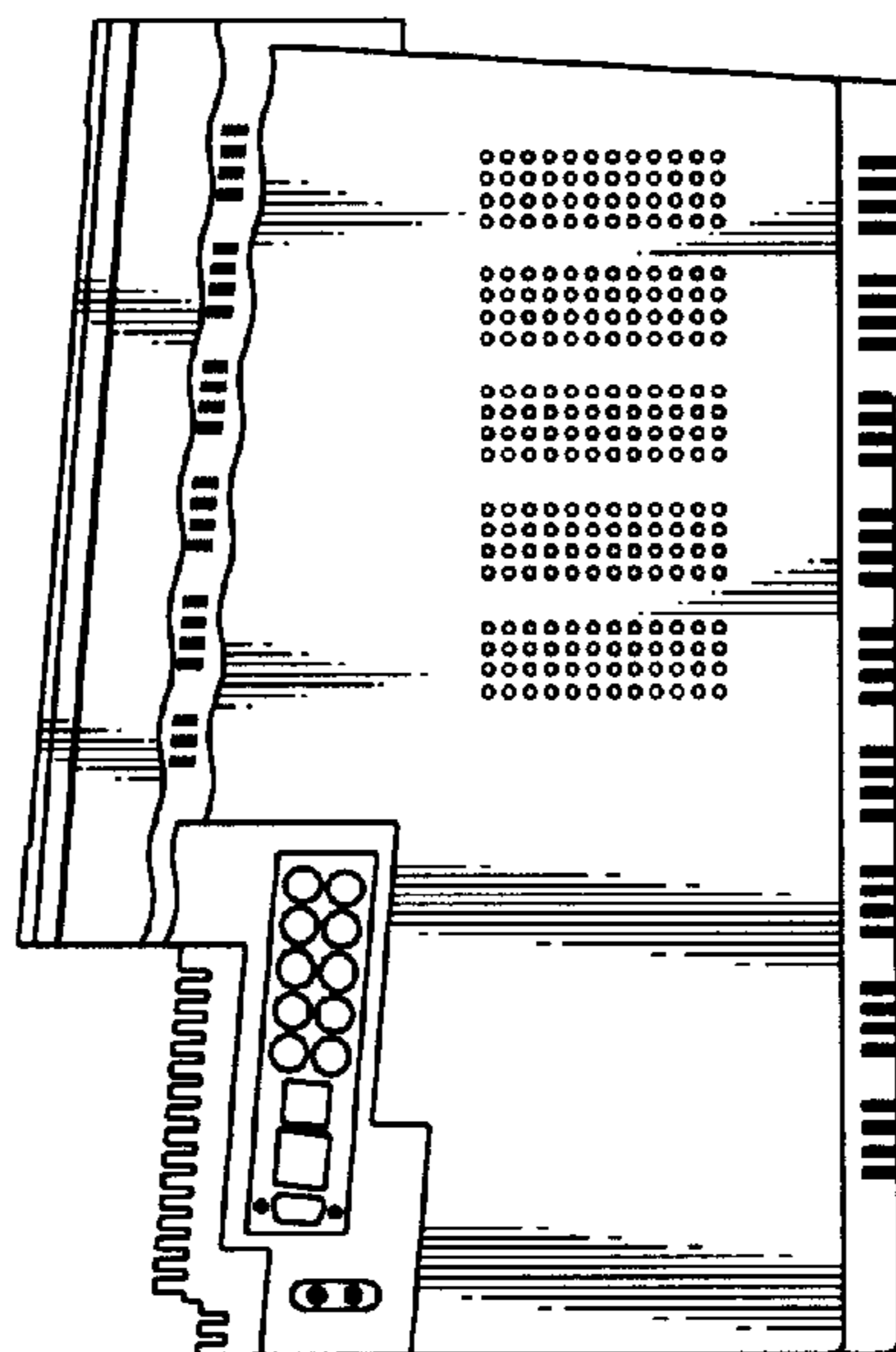

FIG.5

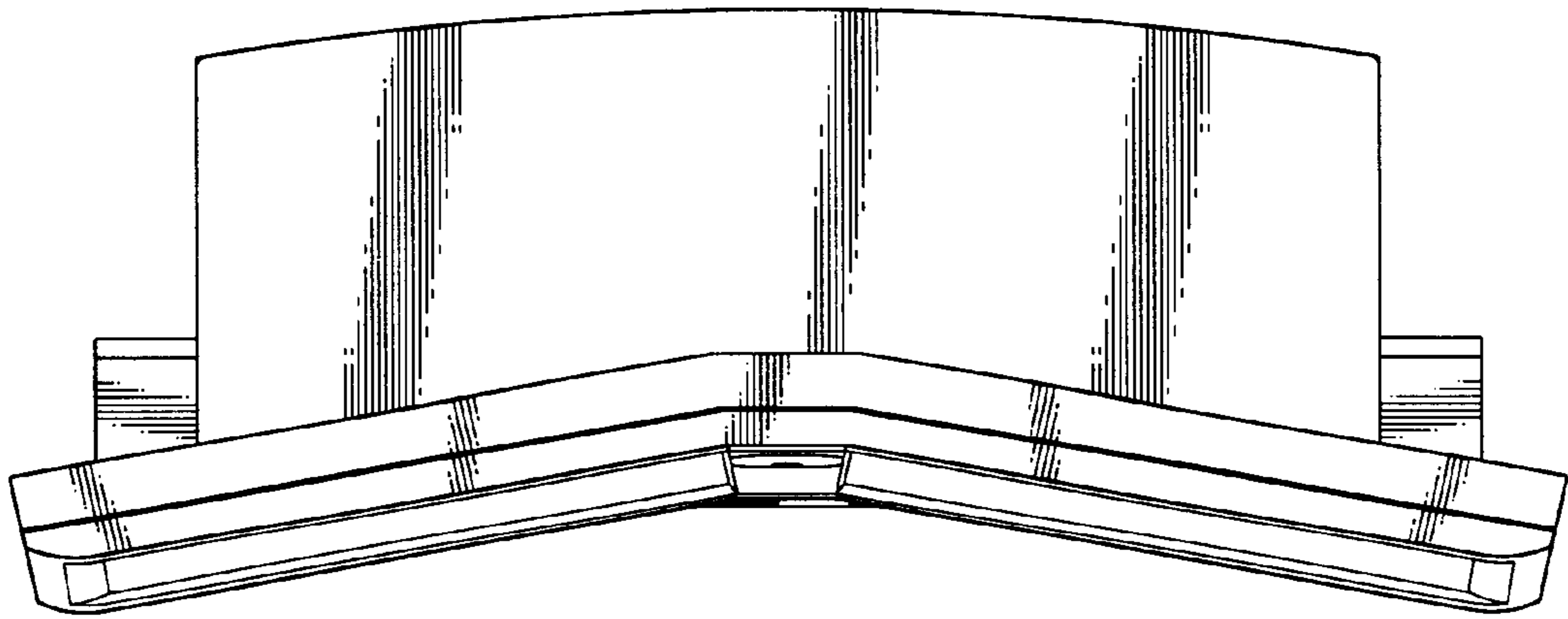

FIG.6

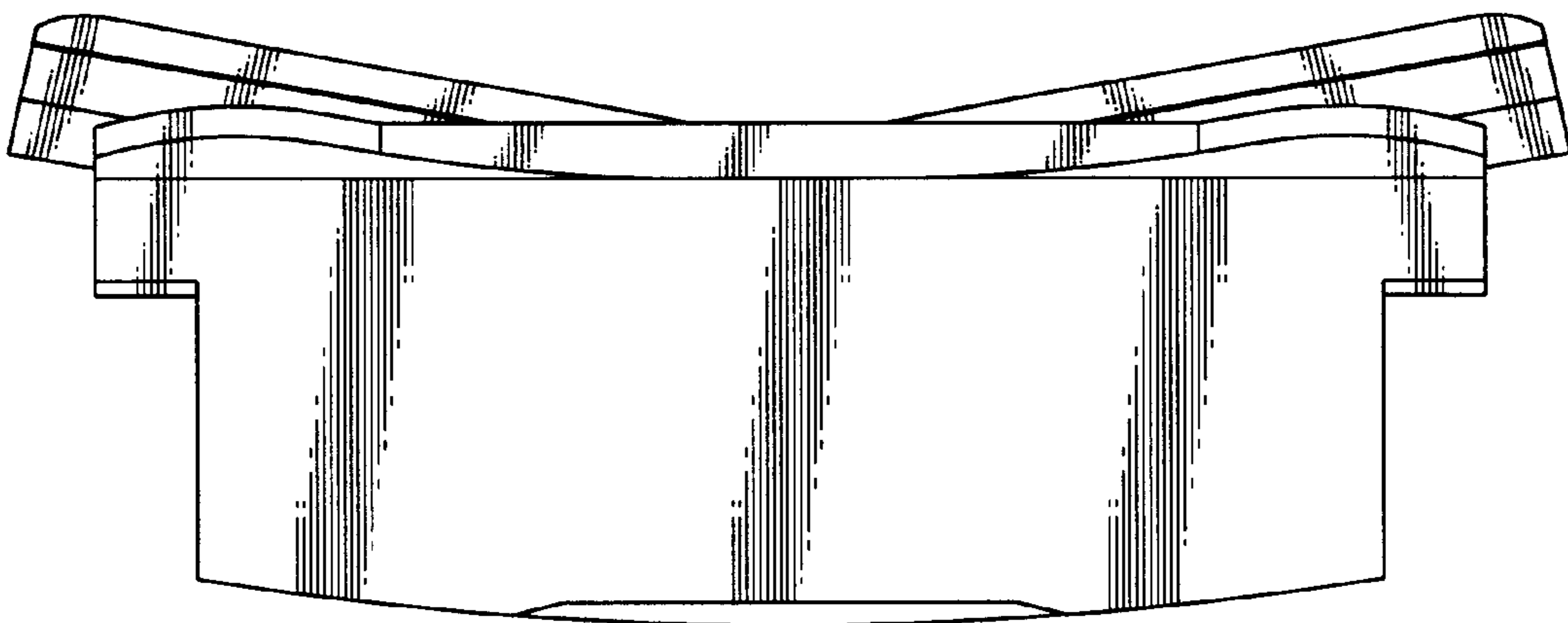

FIG. 7

