



US00D455742S

(12) **United States Design Patent**
Kiai

(10) **Patent No.:** **US D455,742 S**

(45) **Date of Patent:** **** Apr. 16, 2002**

(54) **FACE PLATE COMPONENT**

(76) **Inventor:** **Amir Kiai**, 2821 McGaw, Irvine, CA
(US) 92614

(**) **Term:** **14 Years**

(21) **Appl. No.:** **29/141,562**

(22) **Filed:** **May 9, 2001**

Related U.S. Application Data

(62) Division of application No. 29/129,795, filed on Sep. 20, 2000, now Pat. No. Des. 447,134.

(51) **LOC (7) Cl.** **14-01**

(52) **U.S. Cl.** **D14/257**

(58) **Field of Search** D14/135-136,
D14/156-157, 160, 162, 164, 168, 172,
188, 197-198, 257, 258; 455/89-90, 345,
347

(56) **References Cited**

U.S. PATENT DOCUMENTS

D303,802 S * 10/1989 Culbertson D14/258

D372,712 S * 8/1996 Starck D14/135
D376,153 S * 12/1996 Larson et al. D14/257
D391,267 S * 2/1998 Lindeman et al. D14/257
D416,264 S * 11/1999 Althans et al. D14/257

* cited by examiner

Primary Examiner—Nanda Bondade

(74) *Attorney, Agent, or Firm*—Anna M. Vradenburgh

(57) **CLAIM**

The ornamental design for a face plate component, as shown and described.

DESCRIPTION

FIG. 1 is a perspective view of a face plate component showing my new design;
FIG. 2 is a top plan view thereof;
FIG. 3 is a bottom plan view thereof;
FIG. 4 is a front view thereof;
FIG. 5 is a rear view thereof;
FIG. 6 is a left side view thereof; and,
FIG. 7 is a right side view thereof.

1 Claim, 2 Drawing Sheets

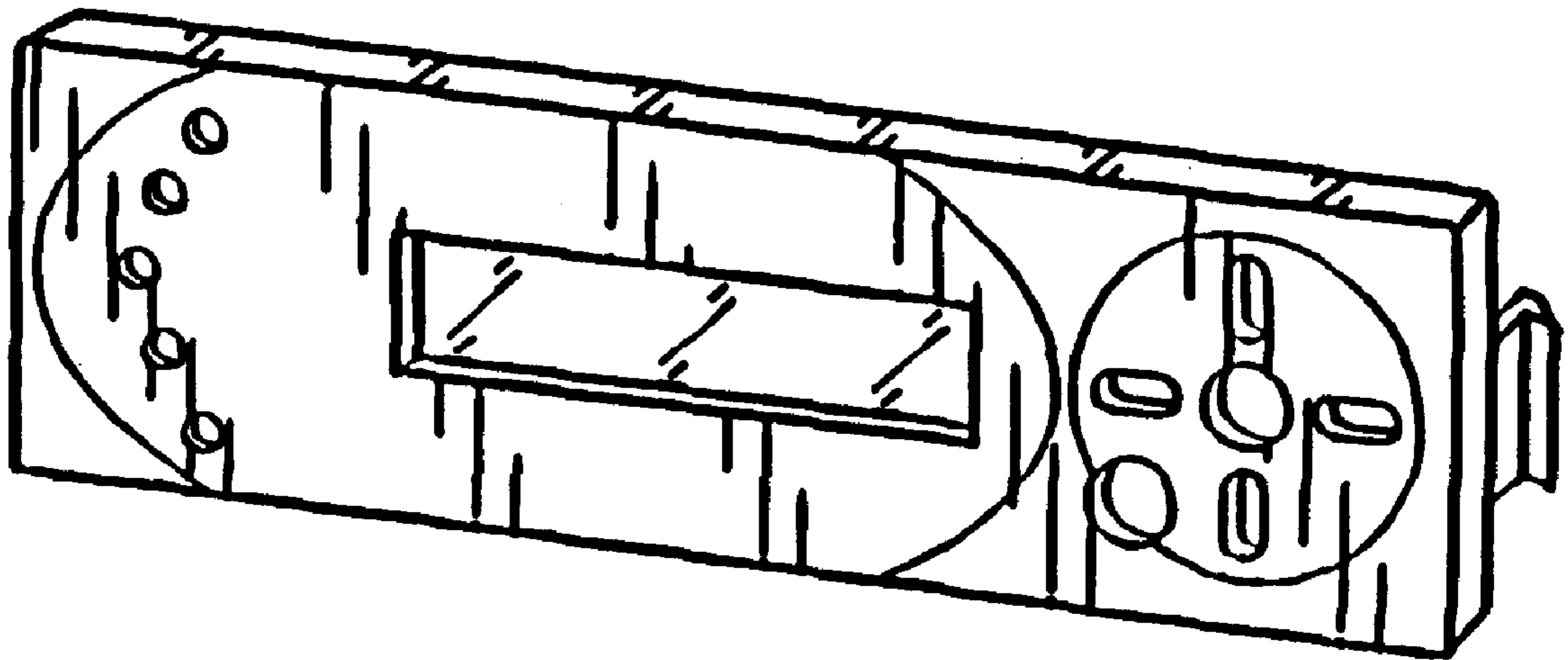

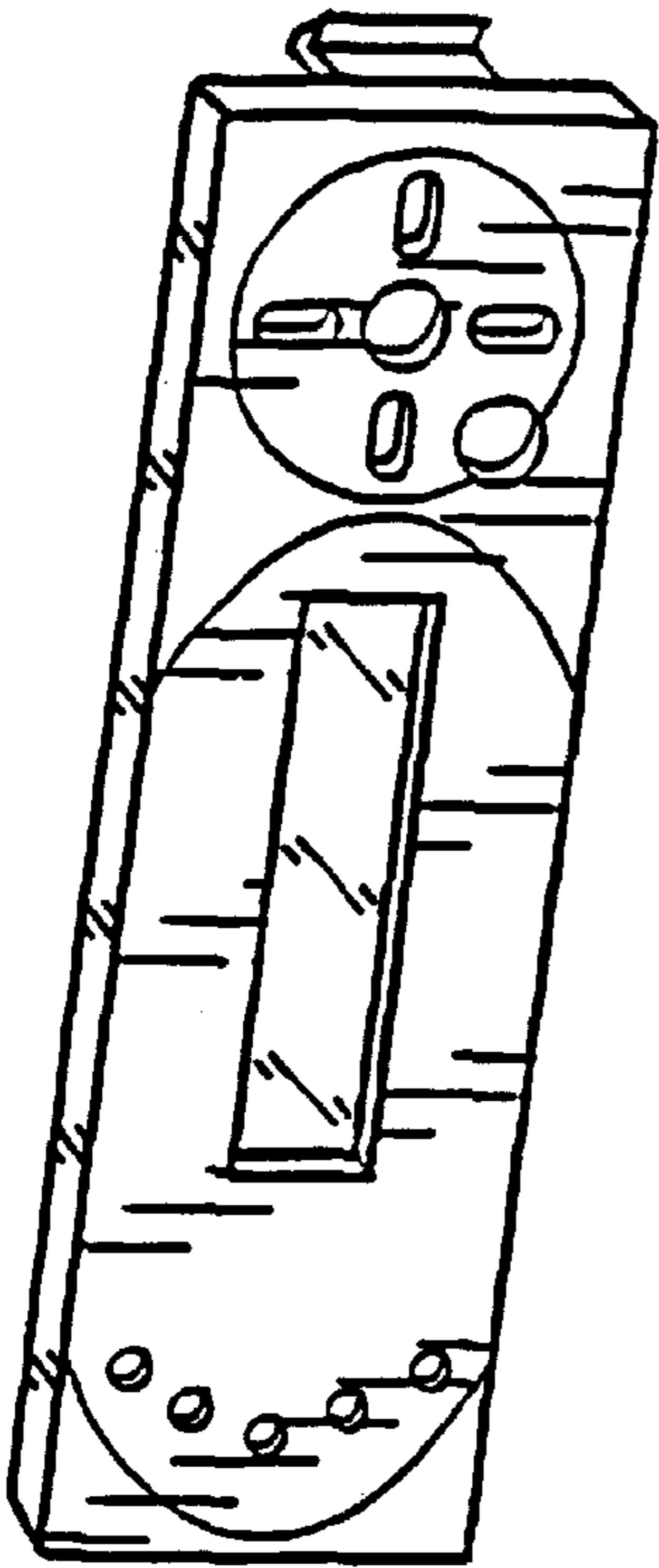

FIG. 1

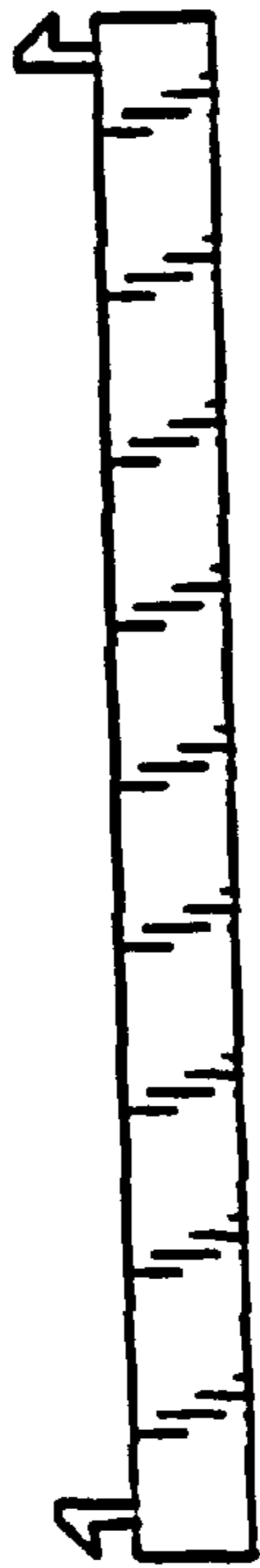

FIG. 2

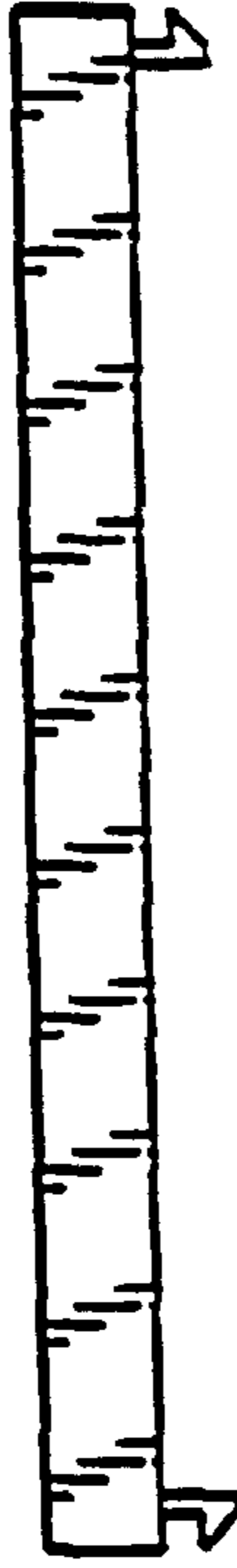

FIG. 3

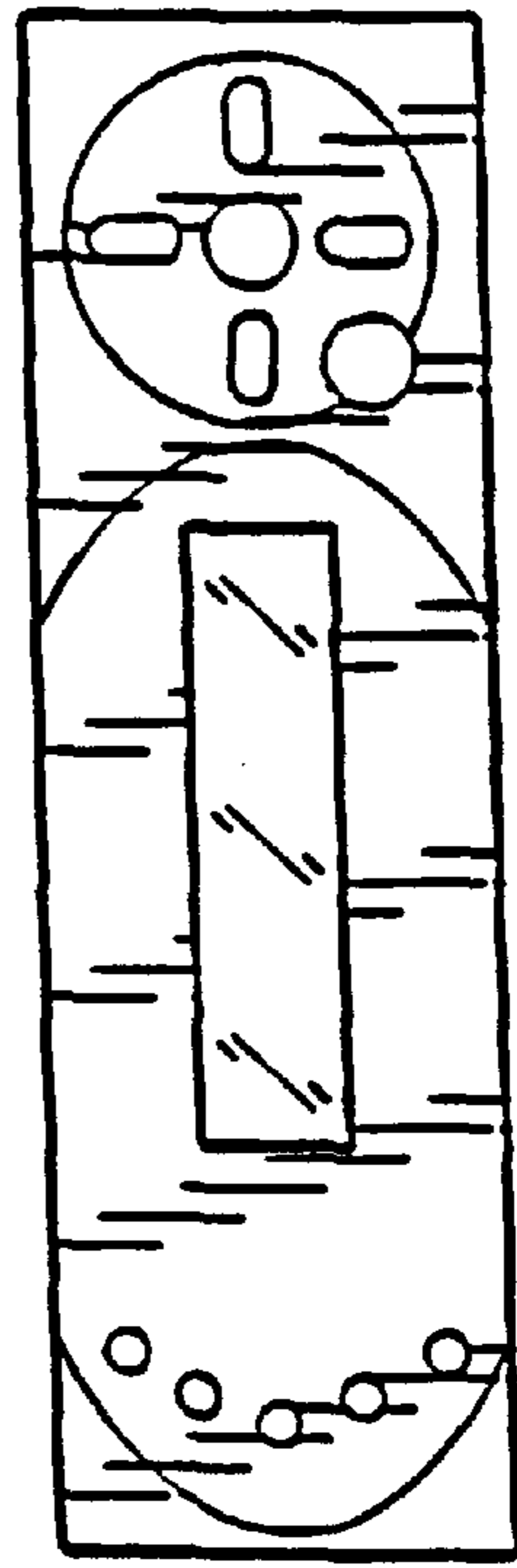

FIG. 4

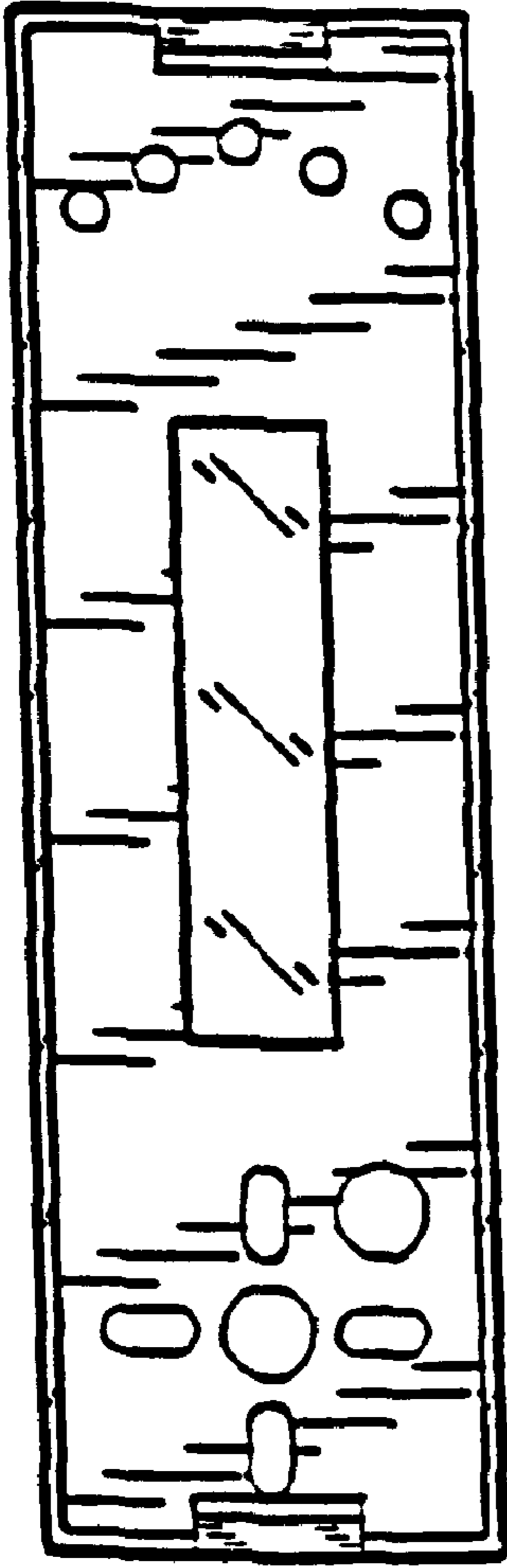

FIG. 5

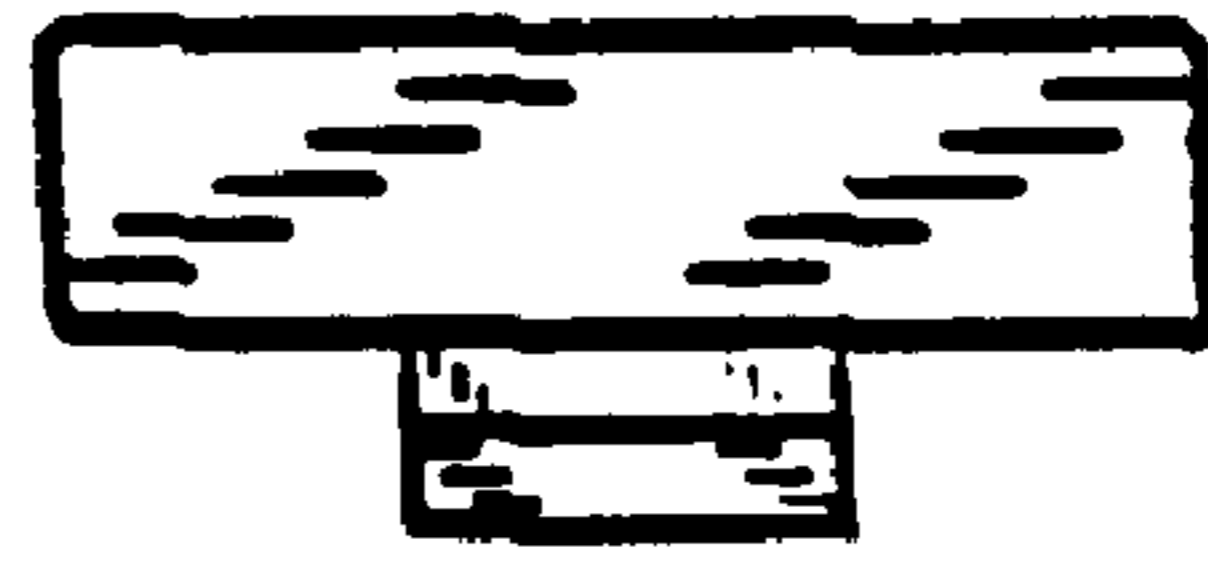

FIG. 6

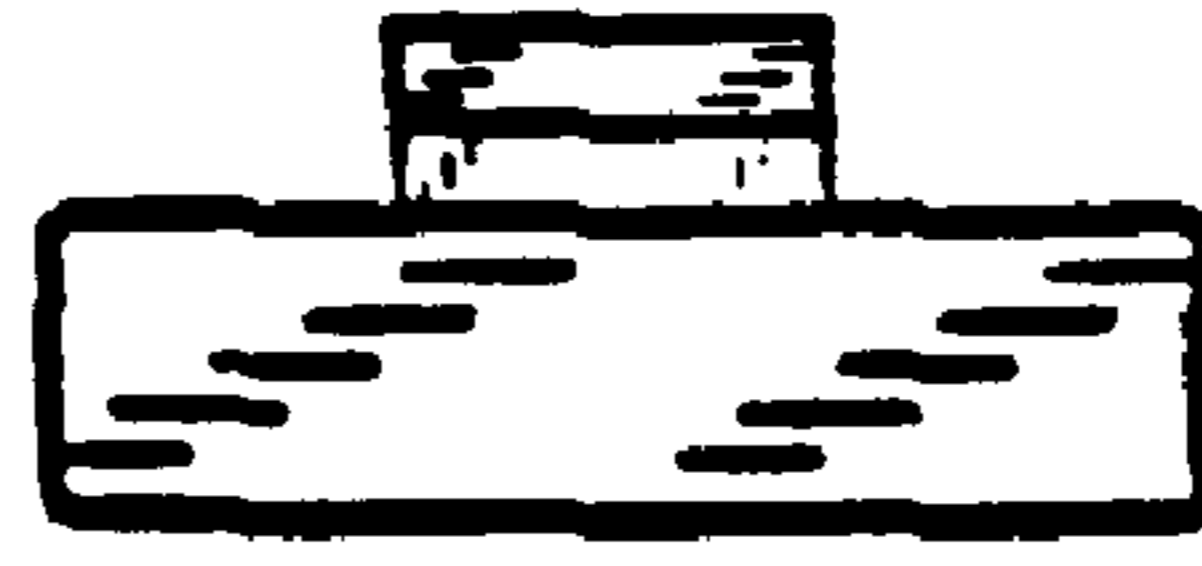

FIG. 7