



US00D455659S

(12) **United States Design Patent**
Goto

(10) **Patent No.:** **US D455,659 S**

(45) **Date of Patent:** **** Apr. 16, 2002**

(54) **COMBINED DIGITAL WATCH AND CAMERA**

(75) **Inventor:** **Atsushi Goto, Kunitachi (JP)**

(73) **Assignee:** **Casio Keisanki Kabushiki Kaisha, Tokyo (JP)**

(**) **Term:** **14 Years**

(21) **Appl. No.:** **29/138,923**

(22) **Filed:** **Mar. 22, 2001**

(51) **LOC (7) Cl.** **10-03**

(52) **U.S. Cl.** **D10/31; D16/200**

(58) **Field of Search** **D10/1-40, 122-132; D16/200-201, 213; 368/41-44, 82-84, 28-30, 239-242, 276-277, 280-282, 285**

(56) **References Cited**

U.S. PATENT DOCUMENTS

D394,401 S	*	5/1998	Moriai et al.	D10/30
D394,610 S	*	5/1998	Ishizaka et al.	D10/30
D400,805 S	*	11/1998	Hanagata	D10/38
D402,900 S	*	12/1998	Hanagata et al.	D10/30
D413,528 S	*	9/1999	Moriai	D10/30
D417,400 S	*	12/1999	Yamamoto	D10/30

D427,917 S	*	7/2000	Hanagata	D10/30
D428,346 S	*	7/2000	Goto et al.	D10/30
D430,807 S	*	9/2000	Moriai	D10/30
D435,221 S	*	12/2000	Nikaido et al.	D10/30
D451,825 S	*	12/2001	Hanagata	D10/30

* cited by examiner

Primary Examiner—Nelson C. Holtje

(74) *Attorney, Agent, or Firm*—Frishauf, Holtz, Goodman, Langer & Chick, P.C.

(57) **CLAIM**

The ornamental design for a combined digital watch and camera, as shown.

DESCRIPTION

FIG. 1 is a front elevational view of a combined digital watch and camera, showing my new design; FIG. 2 is a right side elevational view thereof; FIG. 3 is a left side elevational view thereof; FIG. 4 is a top plan view thereof; FIG. 5 is a bottom plan view thereof; FIG. 6 is a rear elevational view thereof; and, FIG. 7 is a front, bottom and right side perspective view thereof.

1 Claim, 3 Drawing Sheets

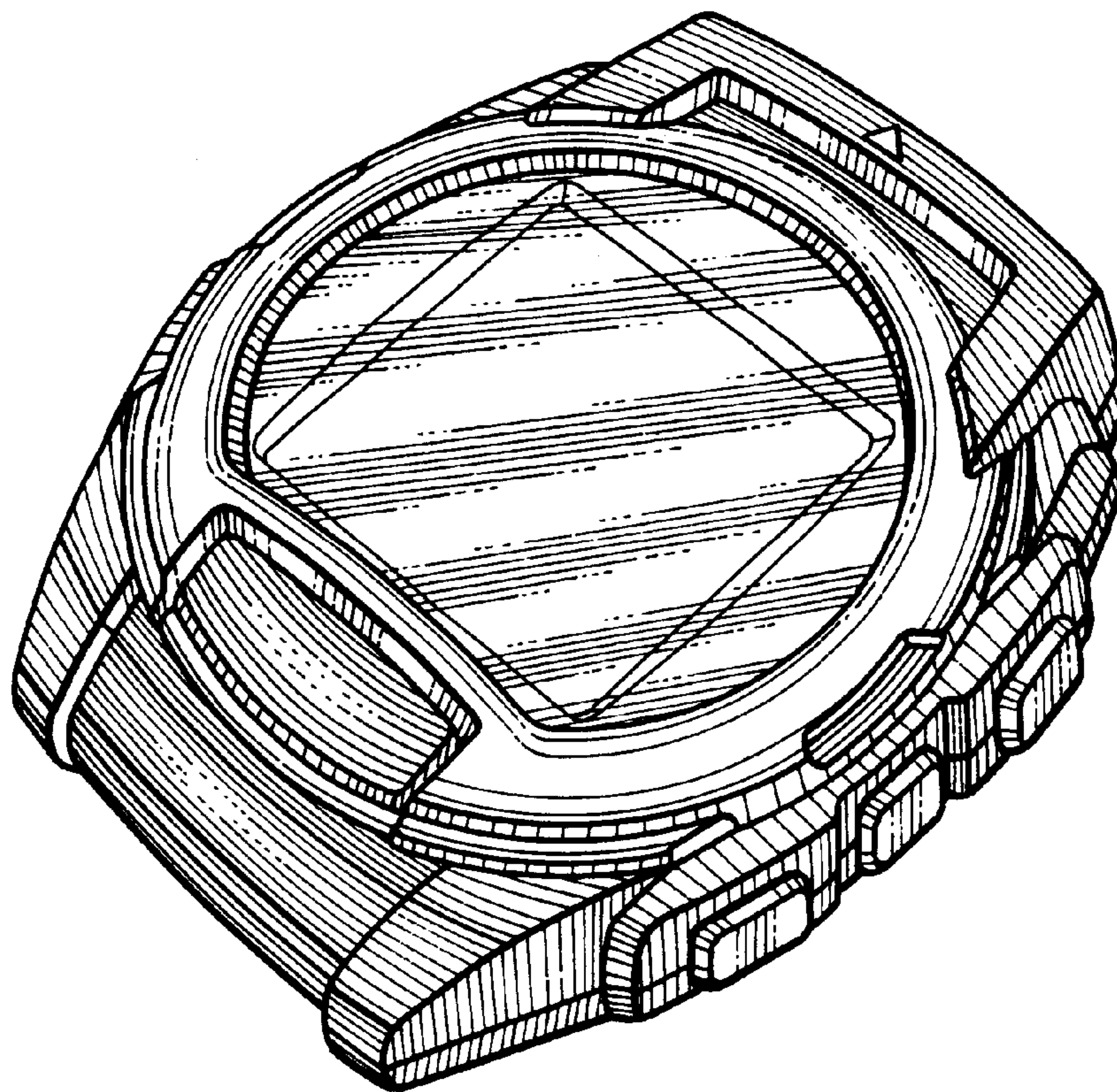

FIG. 1

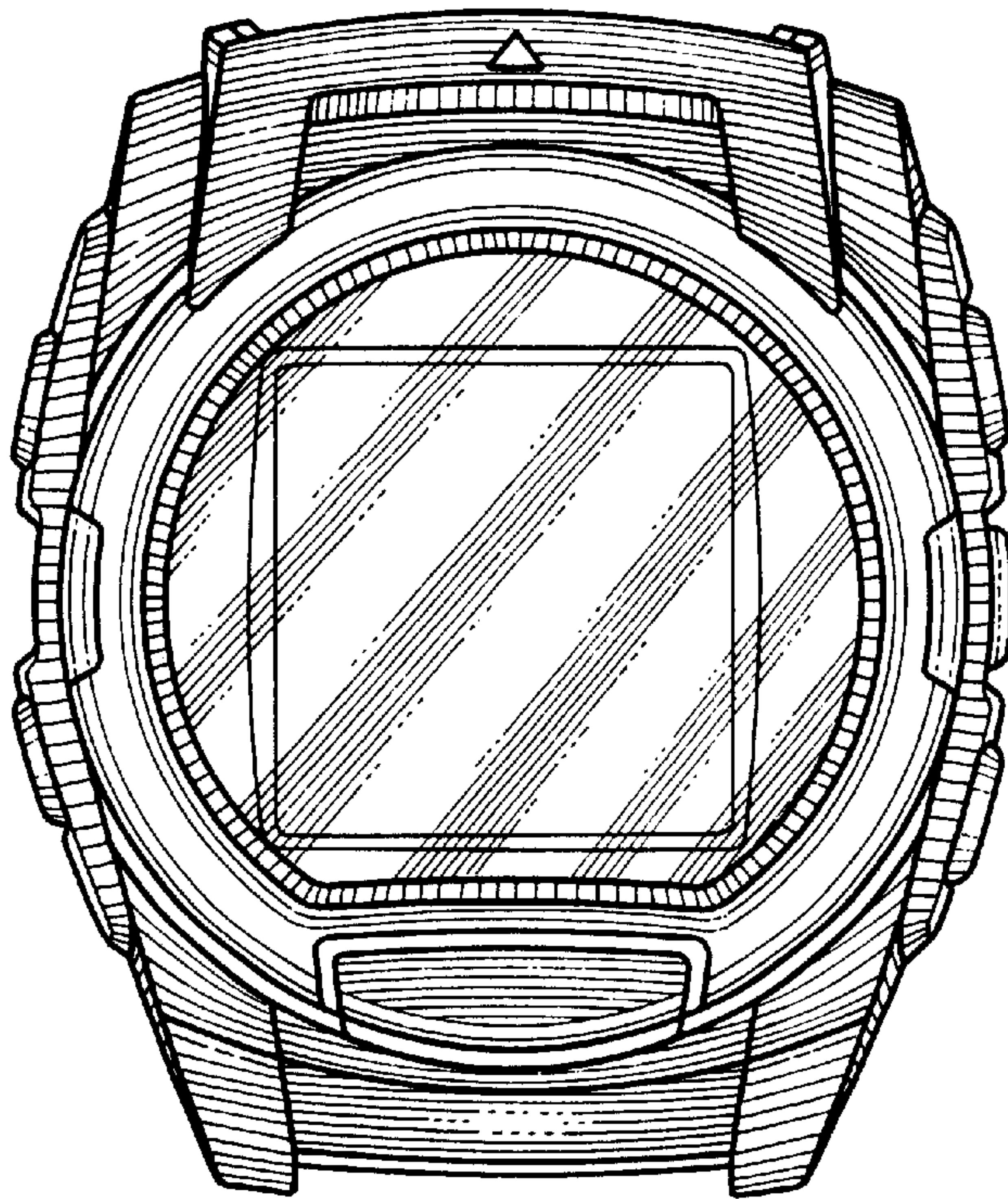

FIG. 2

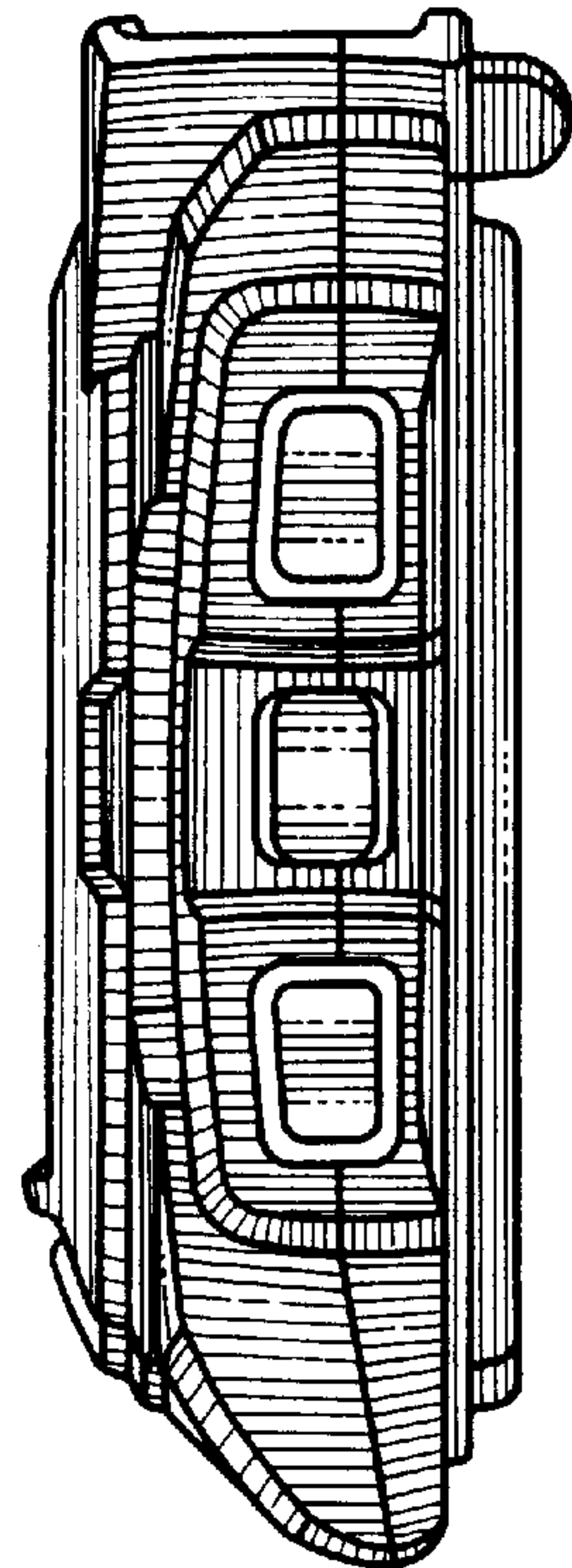

FIG. 5

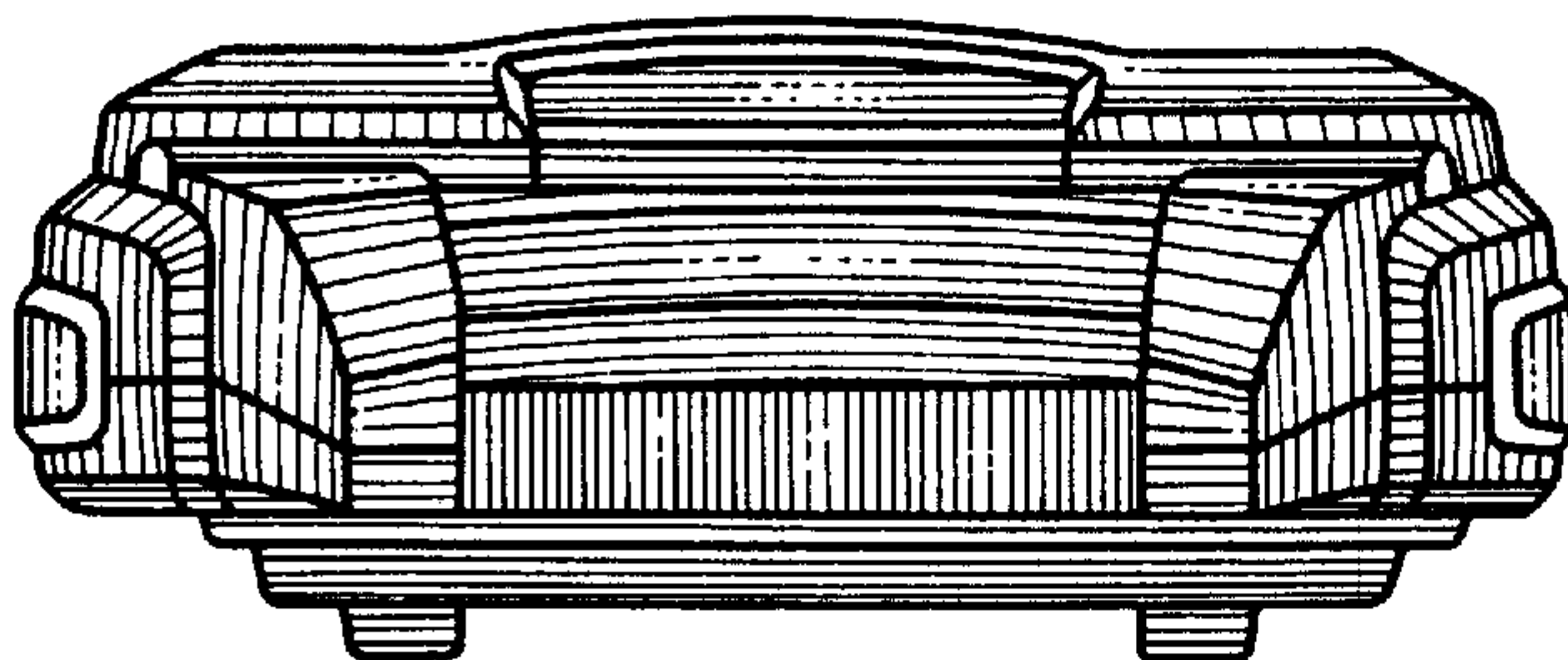

FIG. 4

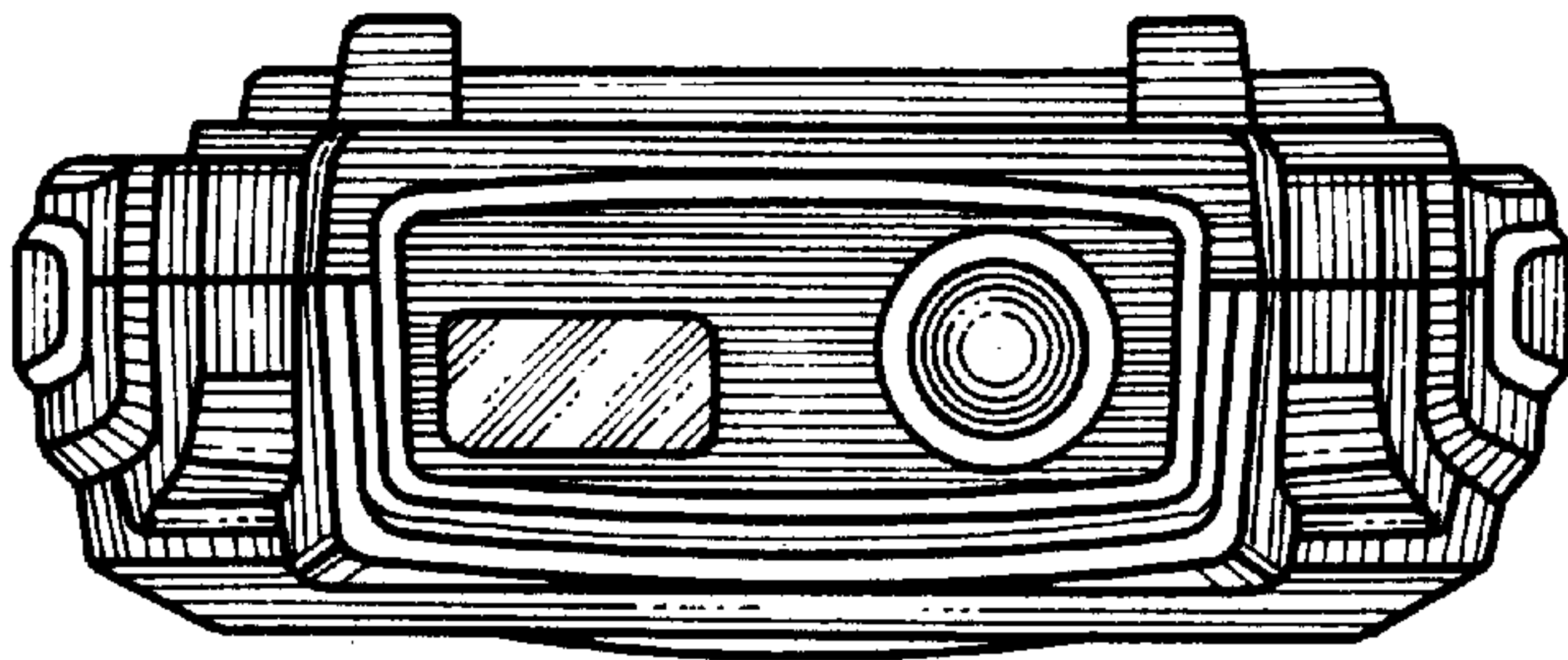

FIG. 6

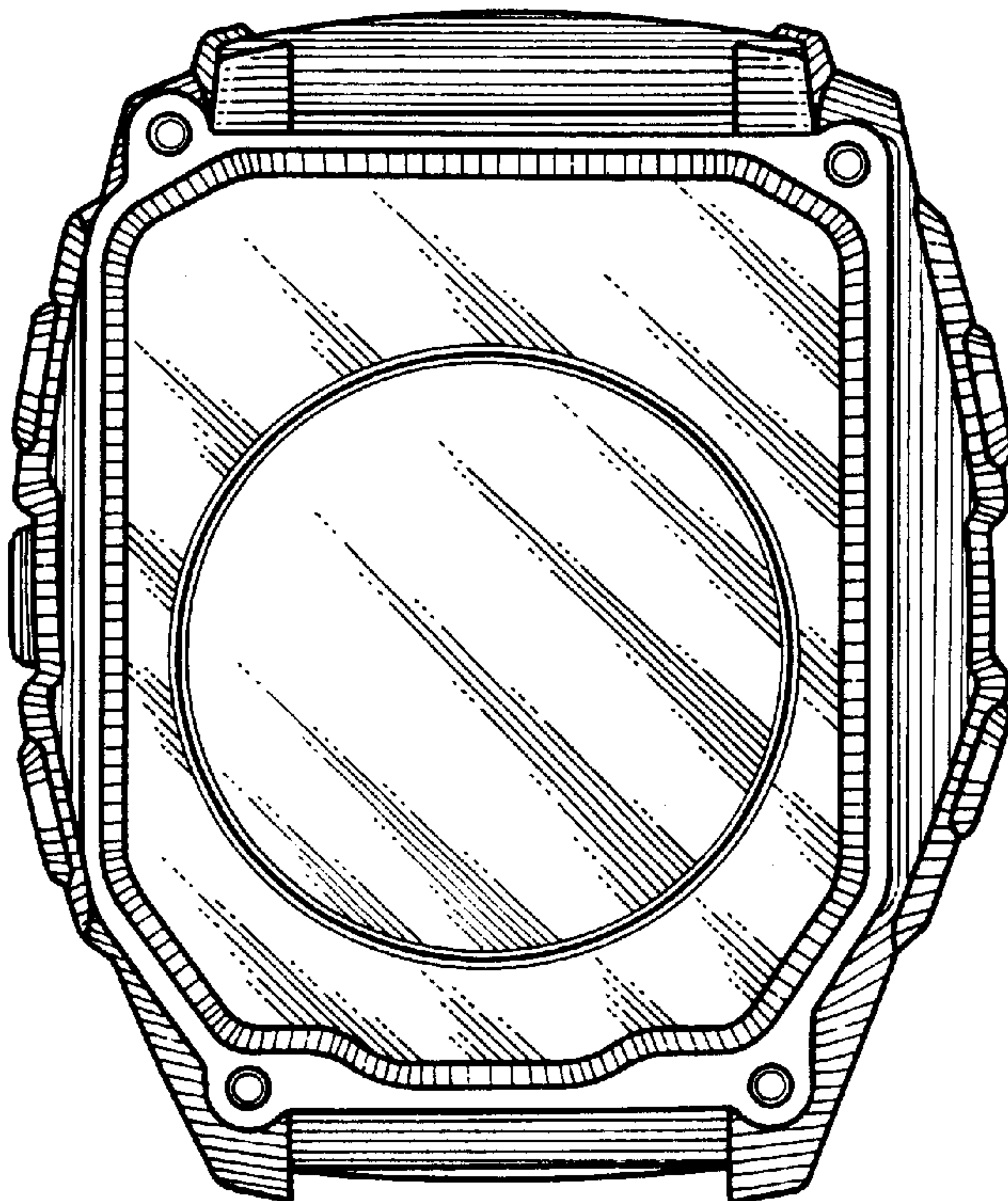

FIG. 3

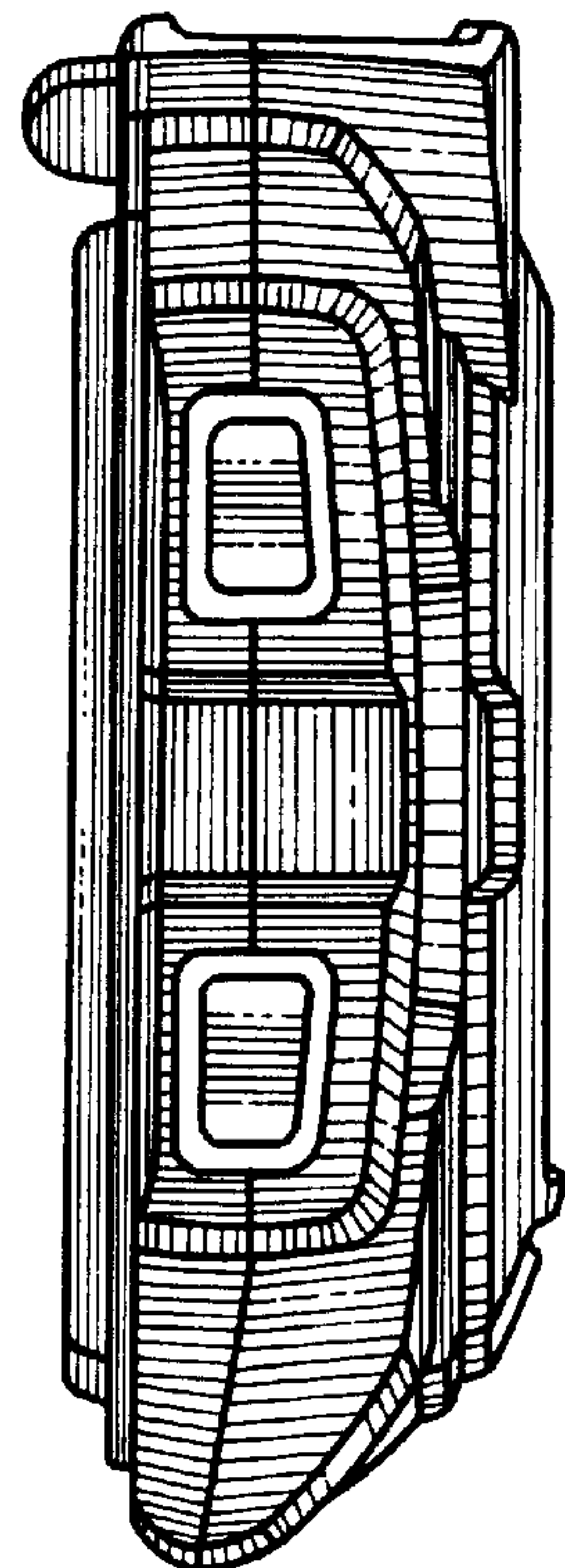

FIG. 7

