



US00D455651S

(12) **United States Design Patent**
Ma

(10) **Patent No.:** **US D455,651 S**

(45) **Date of Patent:** **** Apr. 16, 2002**

(54) **PACKAGING BOX**

(75) Inventor: **Philip Ma**, Coquitlam (CA)

(73) Assignee: **Goldlok Toys Manufactory Co., Ltd.**,
Kowloon (CN)

(**) Term: **14 Years**

(21) Appl. No.: **29/138,290**

(22) Filed: **Mar. 9, 2001**

(51) **LOC (7) Cl.** **09-03**

(52) **U.S. Cl.** **D9/418**

(58) **Field of Search** D9/418, 415, 431,
D9/337, 414, 432; 206/769-773, 579, 775-783,
461-471; 229/162, 103.2, 108, 116.1, 116.4

(56) **References Cited**

U.S. PATENT DOCUMENTS

- 2,498,757 A * 2/1950 High 206/776
- 3,026,997 A * 3/1962 Bianchi, Jr. et al. 206/776 X
- 3,172,768 A * 3/1965 Joosten et al. 206/471
- D255,065 S * 5/1980 Salacuse D9/347
- 5,064,056 A * 11/1991 Gresh 206/470

- D398,226 S * 9/1998 Lal et al. D9/418
- 5,868,249 A * 2/1999 Ehnert 206/775
- D424,428 S * 5/2000 Hart D9/418

* cited by examiner

Primary Examiner—Prabhakar Deshmukh

(74) *Attorney, Agent, or Firm*—Alix, Yale & Ristas, LLP

(57) **CLAIM**

The ornamental design for a packaging box, as shown and described.

DESCRIPTION

FIG. 1 is a front perspective view of the packaging box showing my new design;
 FIG. 2 is a front view of the packaging box of FIG. 1;
 FIG. 3 is a rear view of the packaging box of FIG. 1;
 FIG. 4 is a left side view of the packaging box of FIG. 1;
 FIG. 5 is a right side view of the packaging box of FIG. 1;
 FIG. 6 is a top plan view of the packaging box of FIG. 1;
 and,
 FIG. 7 is a bottom plan view of the packaging box of FIG. 1.

1 Claim, 7 Drawing Sheets

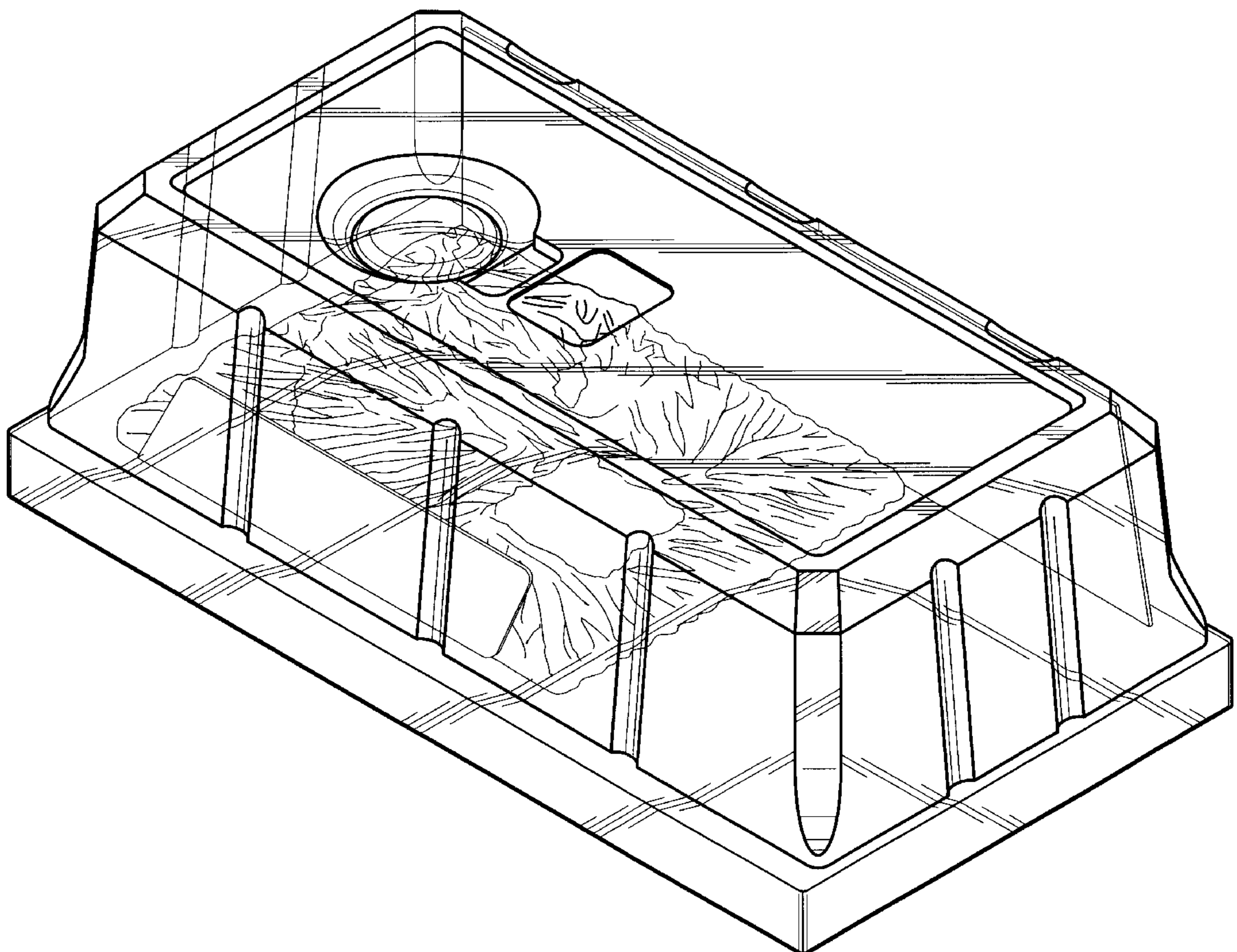

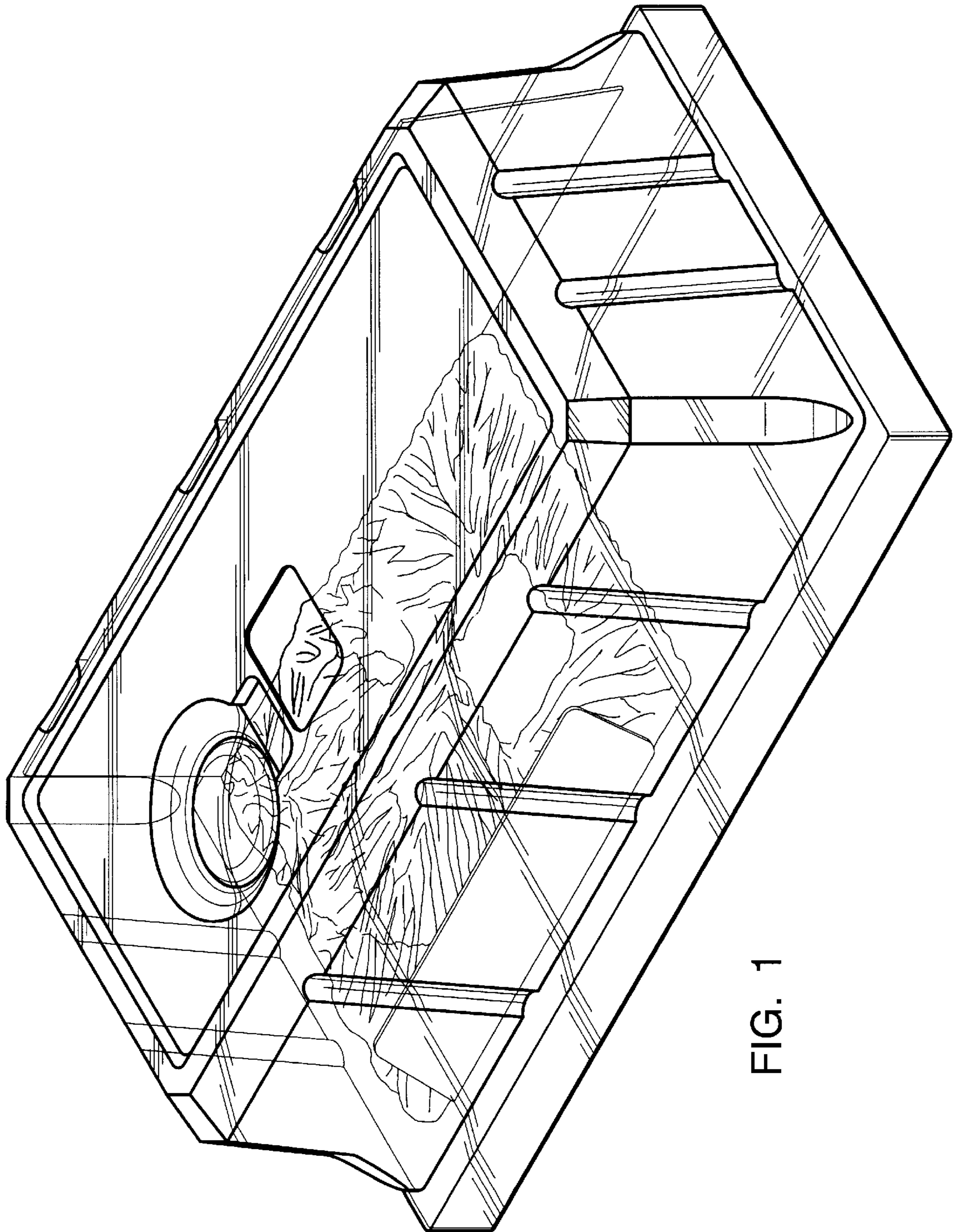

FIG. 1

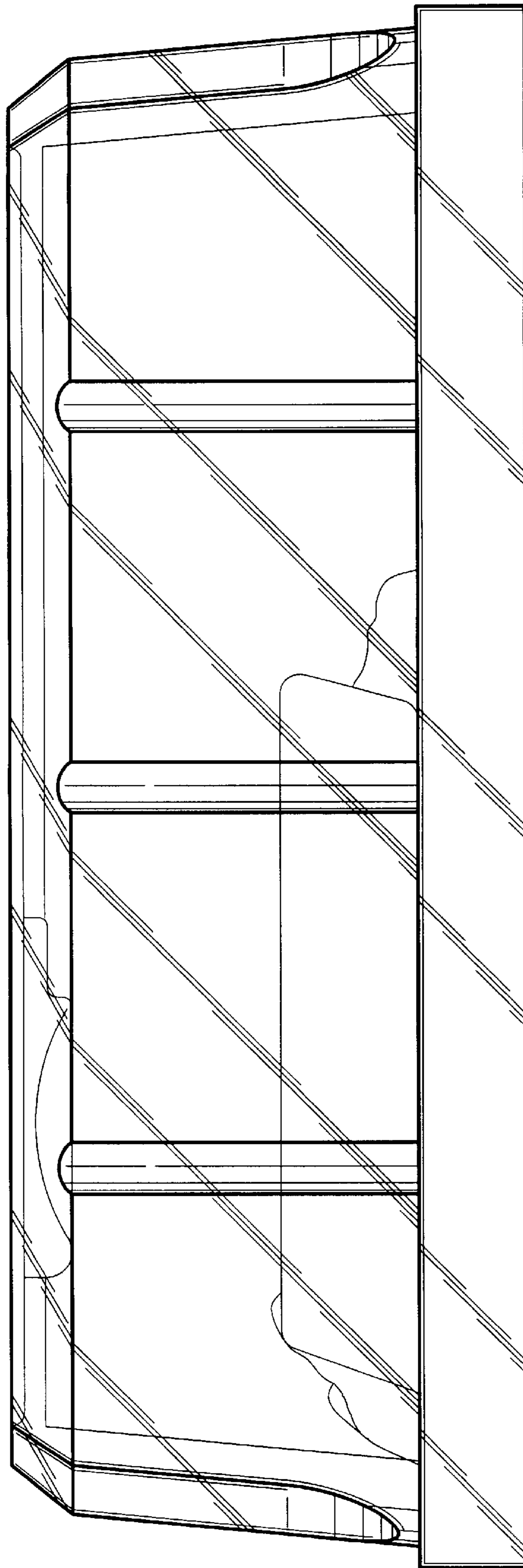

FIG. 2

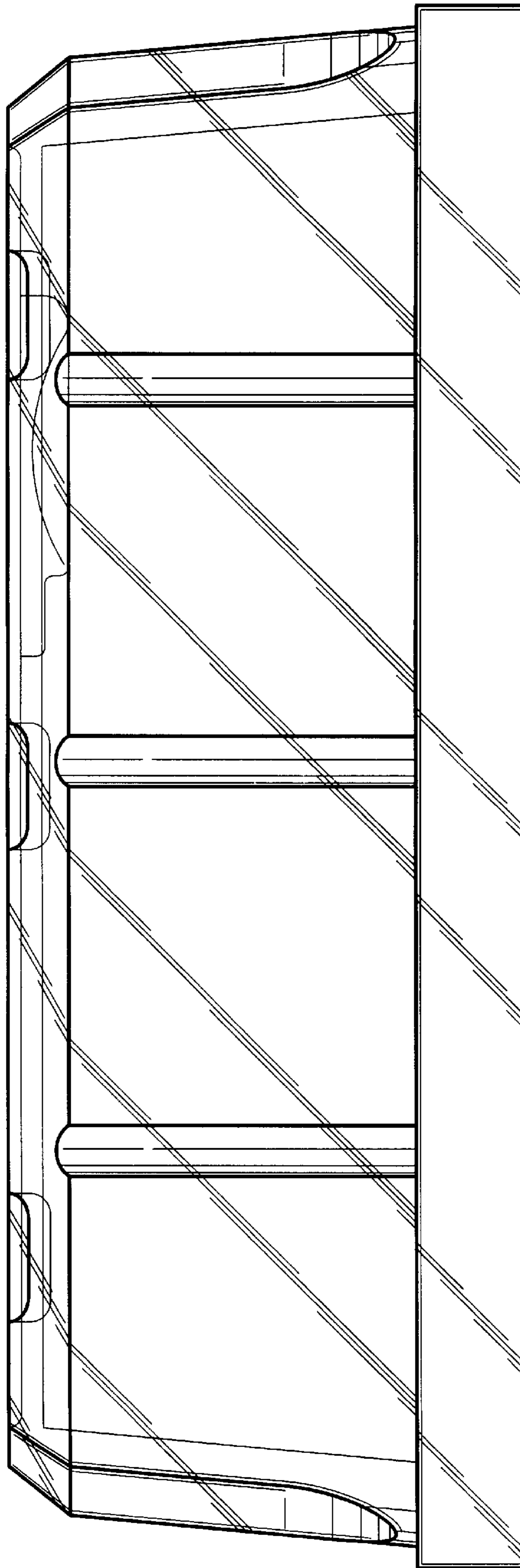

FIG. 3

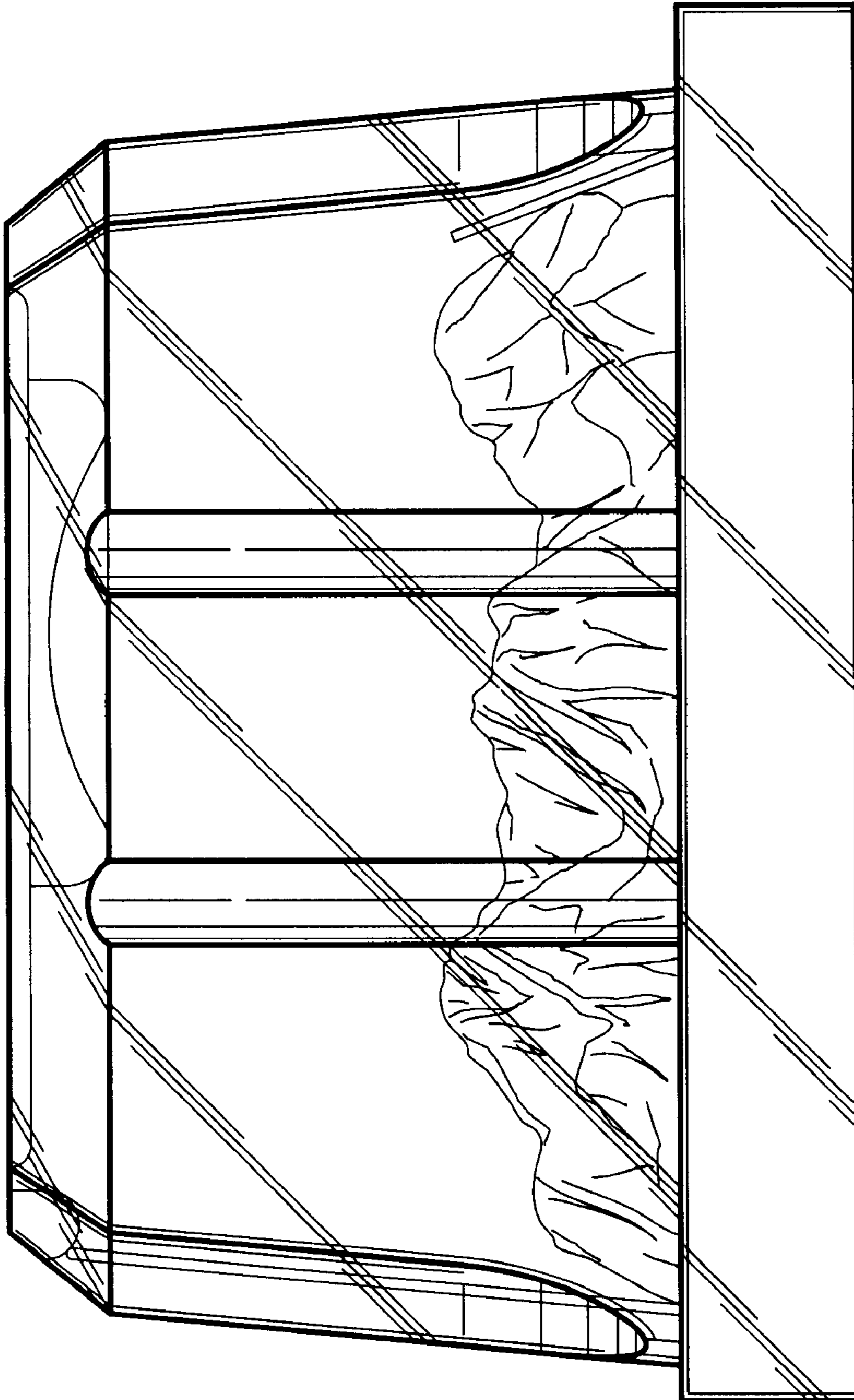

FIG. 4

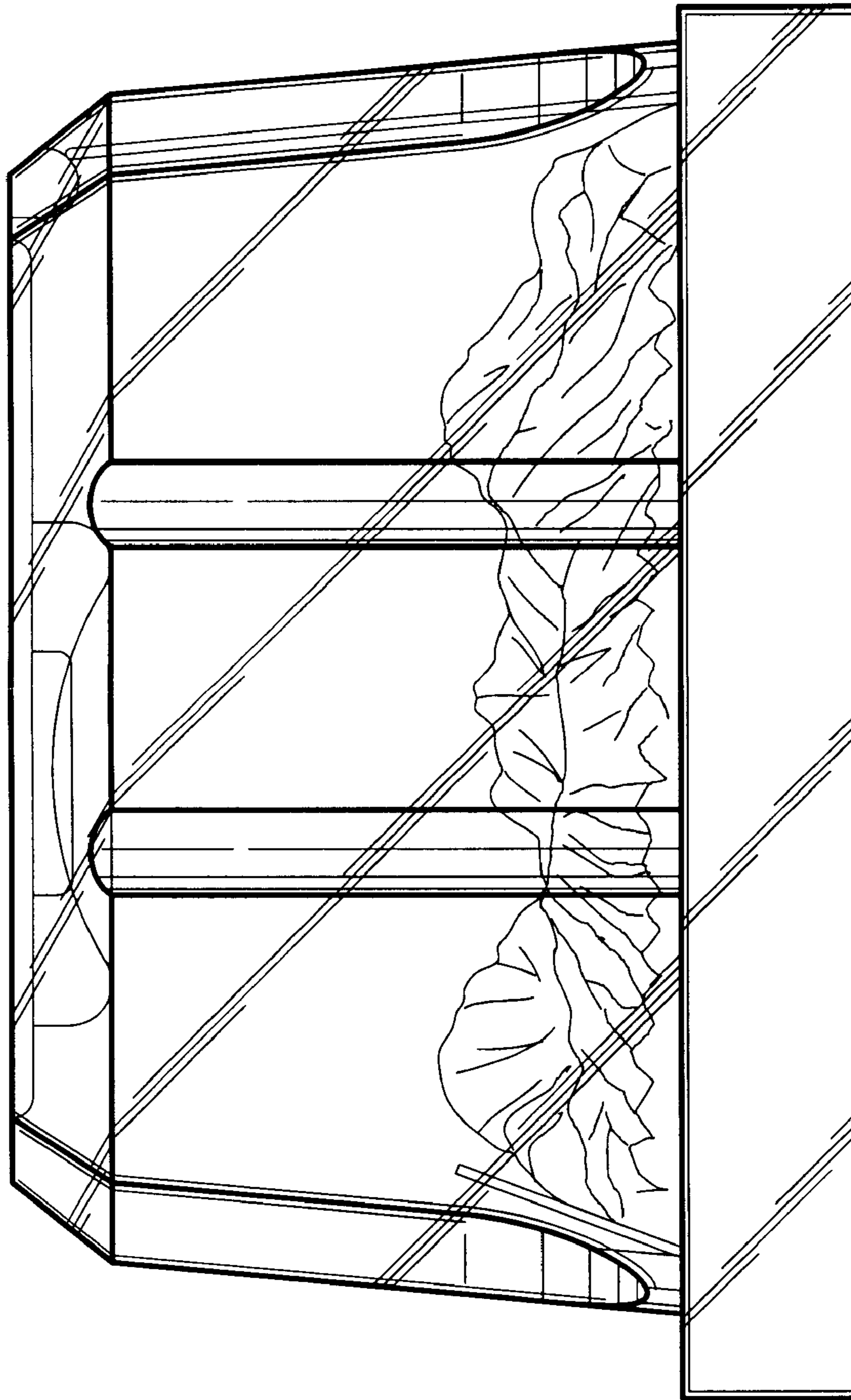

FIG. 5

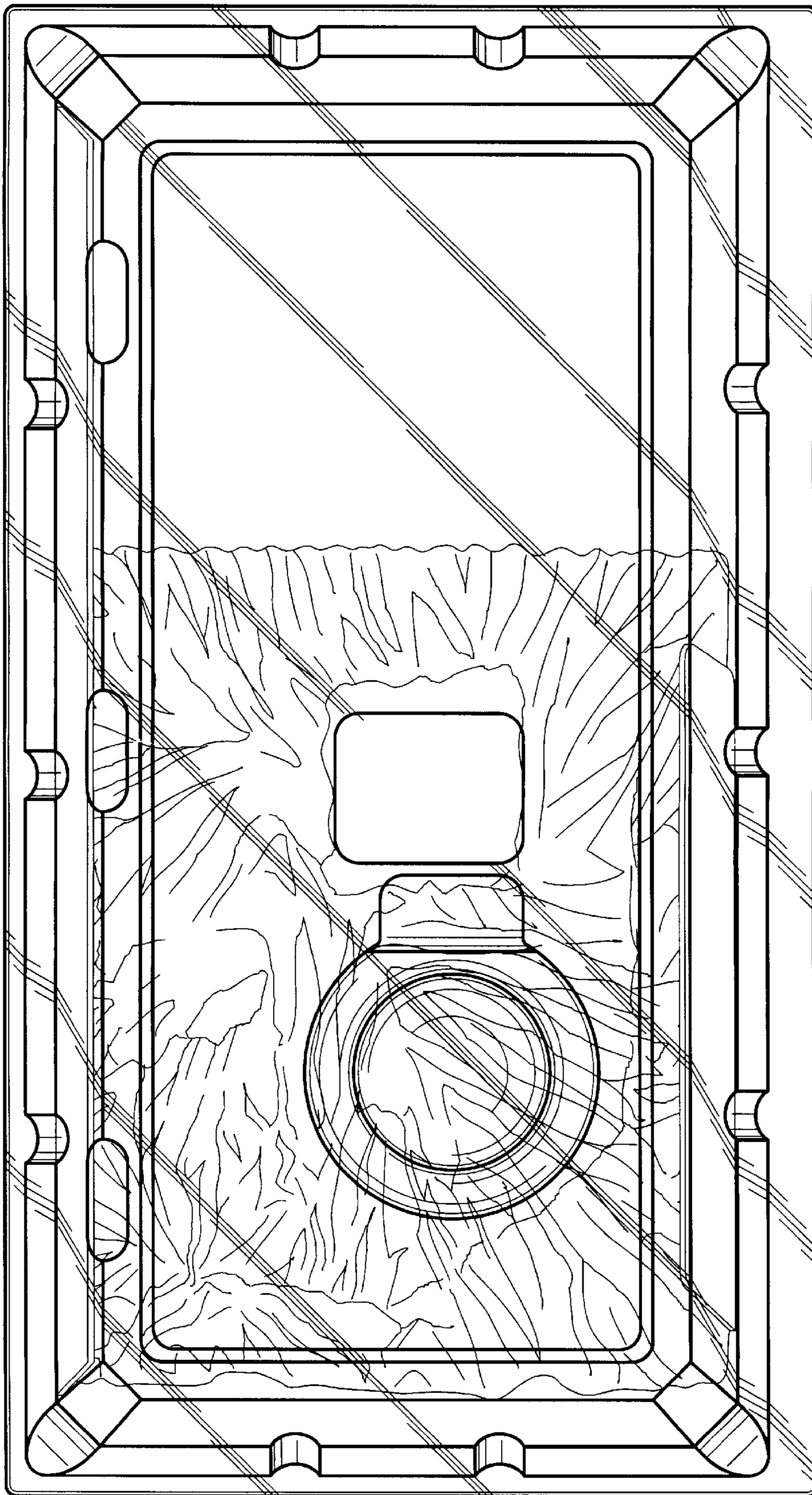

FIG. 6

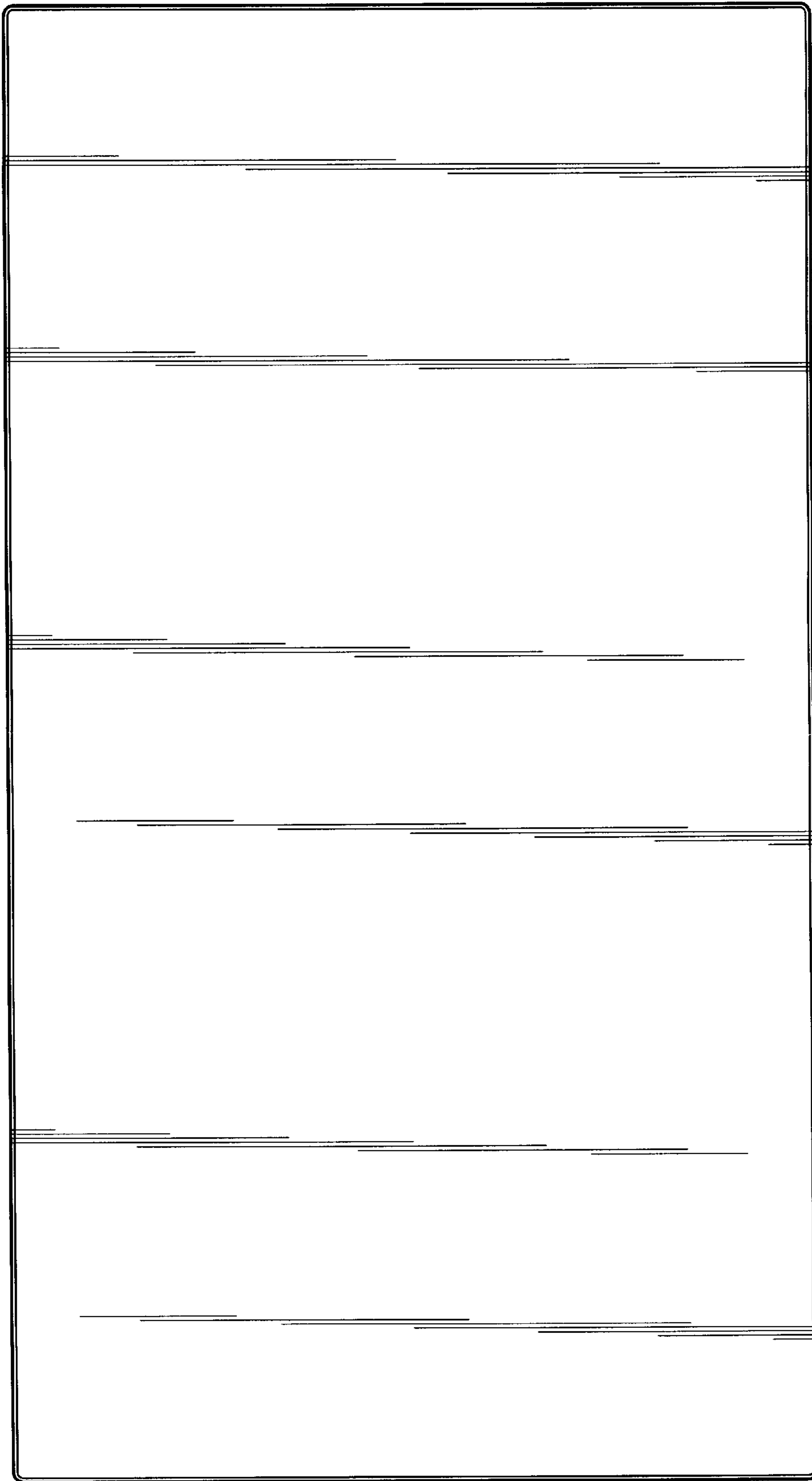

FIG. 7