



US00D455422S

(12) **United States Design Patent**
Bath

(10) **Patent No.:** **US D455,422 S**

(45) **Date of Patent:** **** Apr. 9, 2002**

DESCRIPTION

(54) **SERVER CASE**

(75) Inventor: **Billy Bath**, Milpitas, CA (US)

(73) Assignee: **Telenet System Solutions, Inc.**, San Jose, CA (US)

(**) Term: **14 Years**

(21) Appl. No.: **29/113,221**

(22) Filed: **Nov. 1, 1999**

(51) **LOC (7) Cl.** **14-02**

(52) **U.S. Cl.** **D14/301; D14/367**

(58) **Field of Search** D14/300, 301,
D14/367, 366; D13/162, 184, 199; 312/208.1;
360/99.12

(56) **References Cited**

U.S. PATENT DOCUMENTS

D322,965 S * 1/1992 Silverstein et al. D14/367
D370,470 S * 6/1996 Wu et al. D14/301

* cited by examiner

Primary Examiner—Freda Nunn

(74) *Attorney, Agent, or Firm*—Carol D. Titus; James J. Leary

(57) **CLAIM**

The ornamental design for a server case, as shown and described.

FIG. 1 is a perspective view of the server case, the broken line showing of the electrical components is for illustrative purposes only and forms no part of the claimed design;

FIG. 2 is a perspective view thereof wherein the broken line showing of the electrical components is removed;

FIG. 3 is a close-up perspective view of a bracket thereof shown separately for clarity of illustration only;

FIG. 4 is a bottom view of the bracket shown in FIG. 3;

FIG. 5 is a front view thereof, the broken line showing of the fans is for illustrative purposes only and forms no part of the claimed design;

FIG. 6 is a front view thereof wherein the broken line showing of the fans is removed;

FIG. 7 is a back view thereof, the broken line showing of the electrical connector is for illustrative purposes only and forms no part of the claimed design;

FIG. 8 is a back view thereof wherein the broken line showing of the electrical connector is removed;

FIG. 9 is a close up perspective view of a portion of the back thereof;

FIG. 10 is a right side view thereof, the broken line showing of associated parts is for illustrative purposes only and forms no part of the claimed design;

FIG. 11 is an exploded right side view thereof;

FIG. 12 is a left side view thereof, the broken line showing of associated parts is for illustrative purposes only and forms no part of the claimed design; and,

FIG. 13 is an exploded left side view thereof.

1 Claim, 7 Drawing Sheets

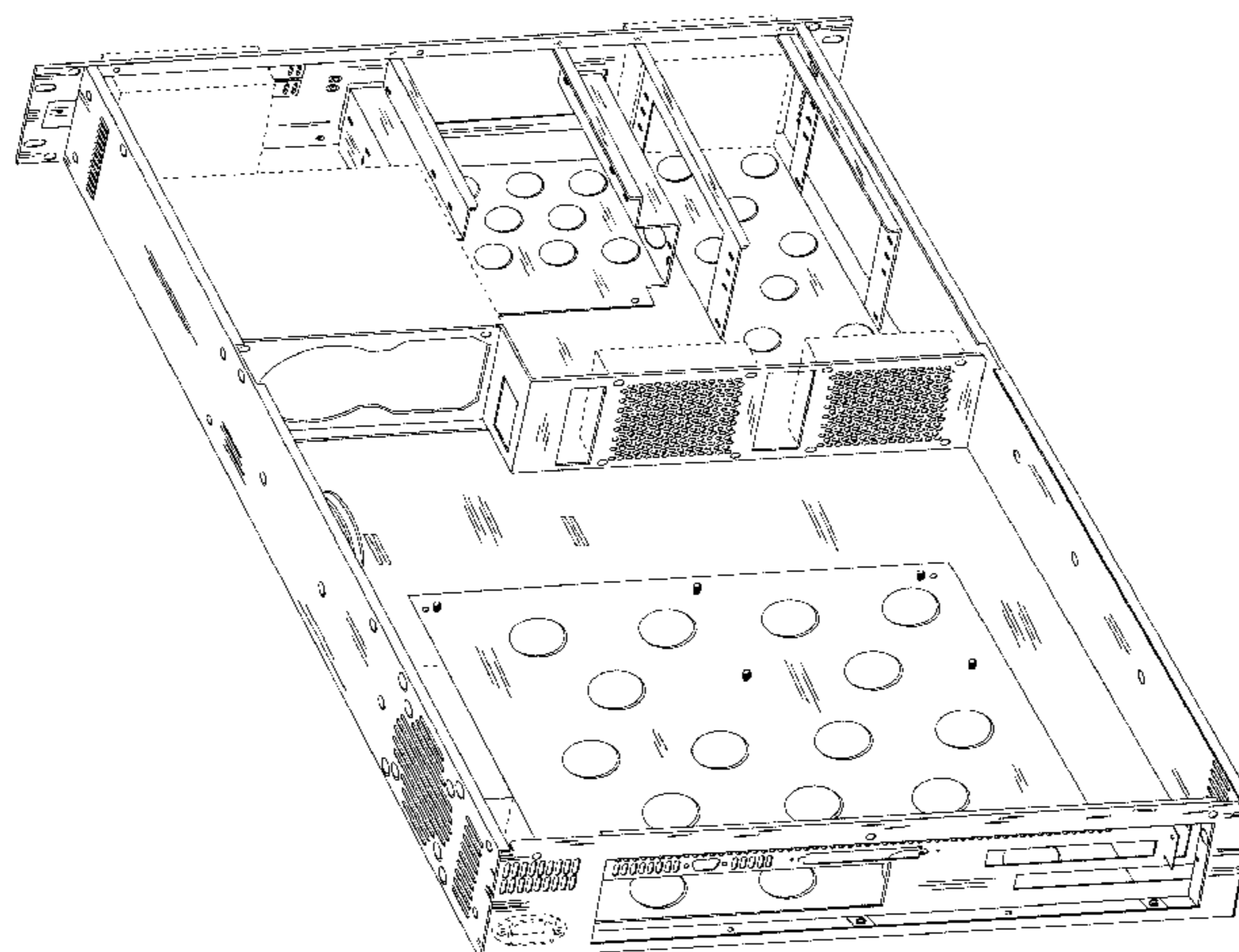

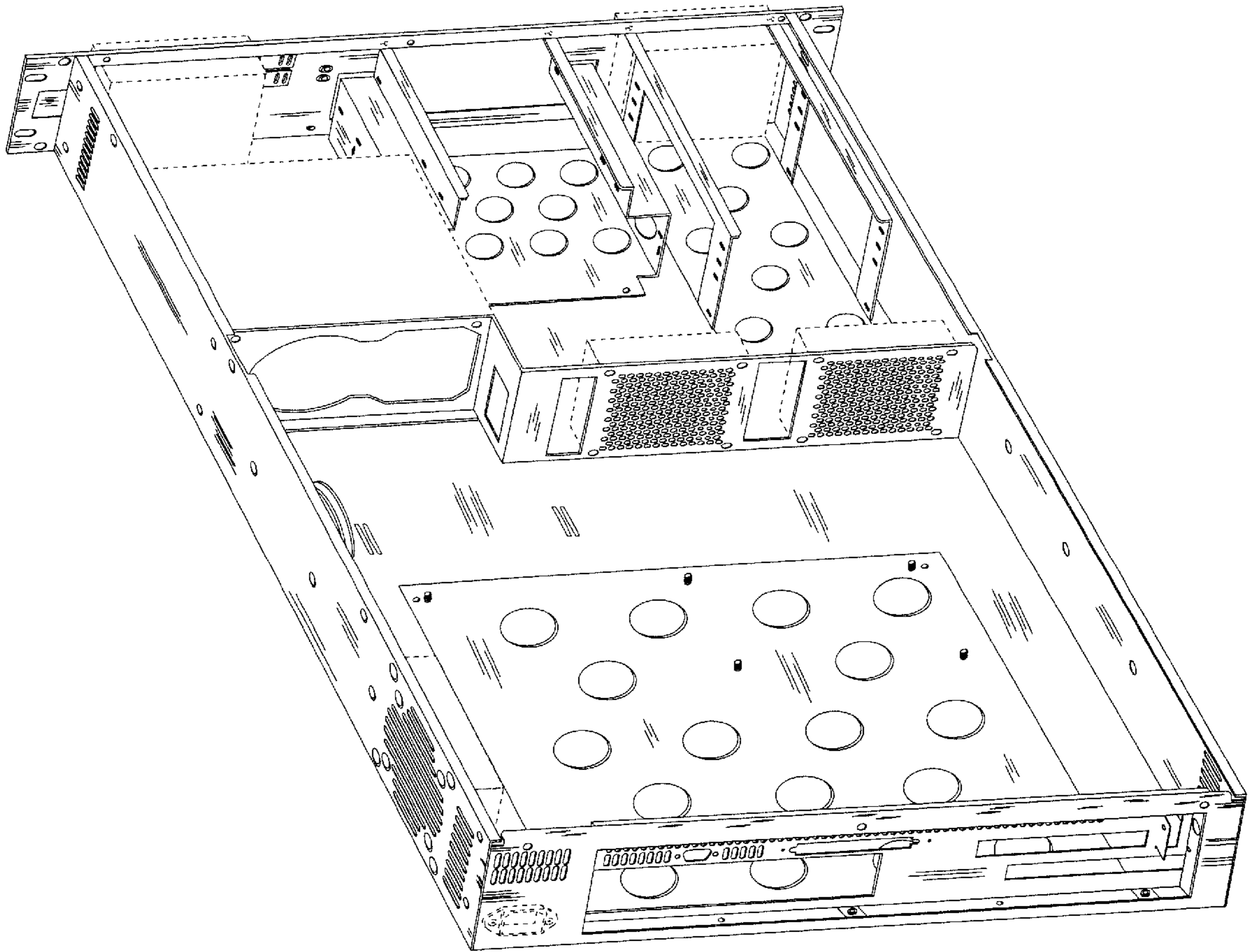

Fig. 1

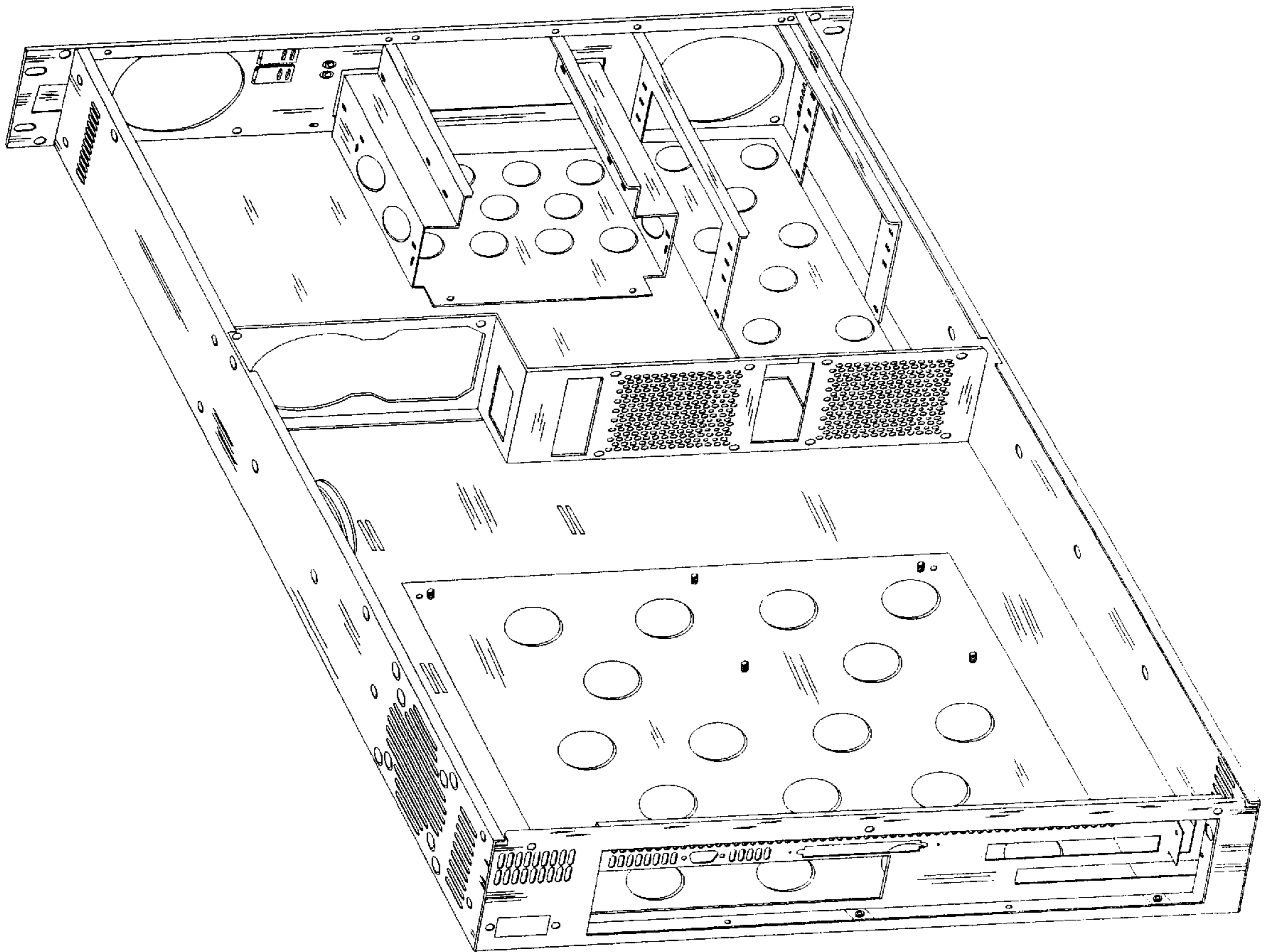

Fig. 2

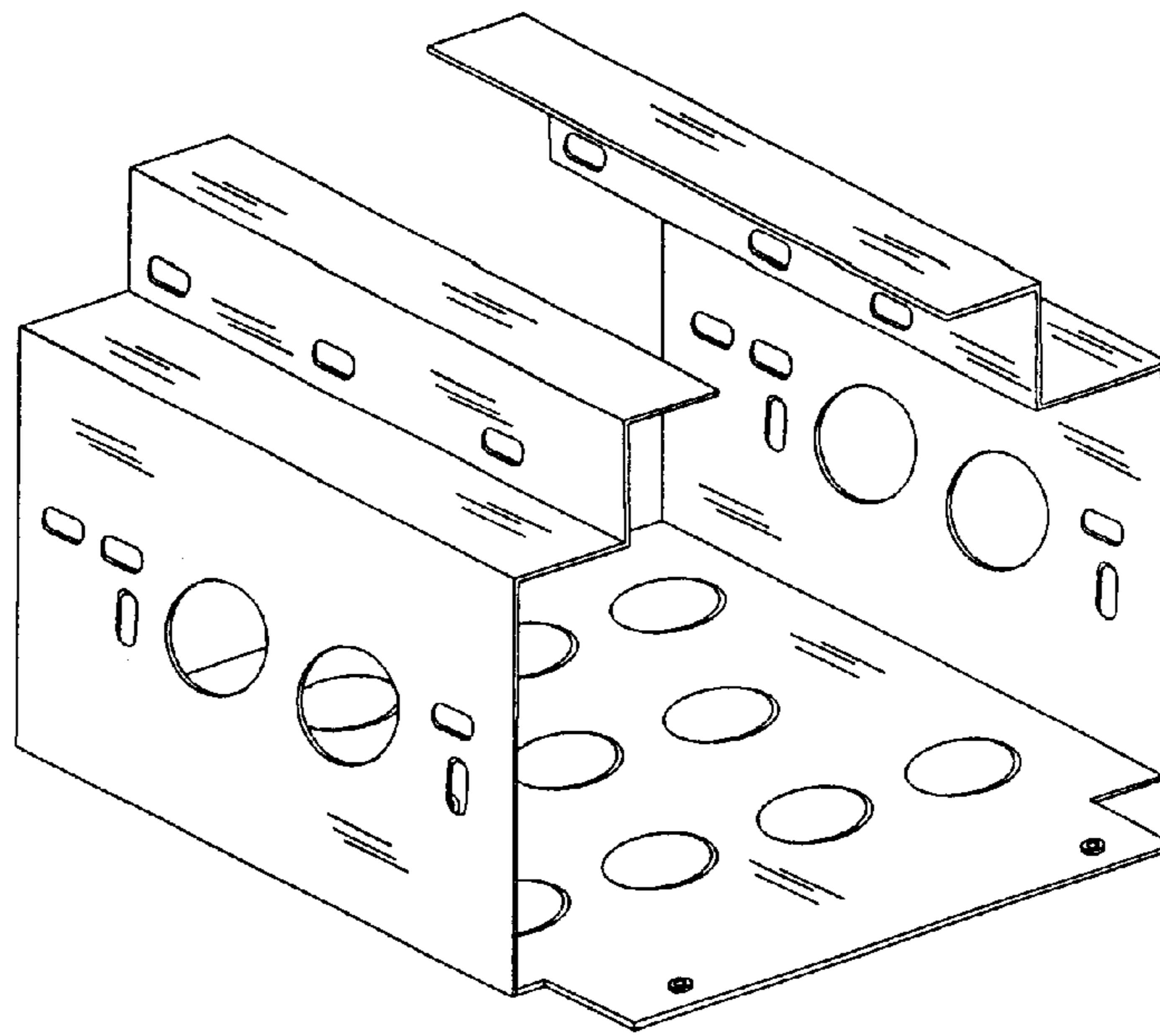

Fig. 3

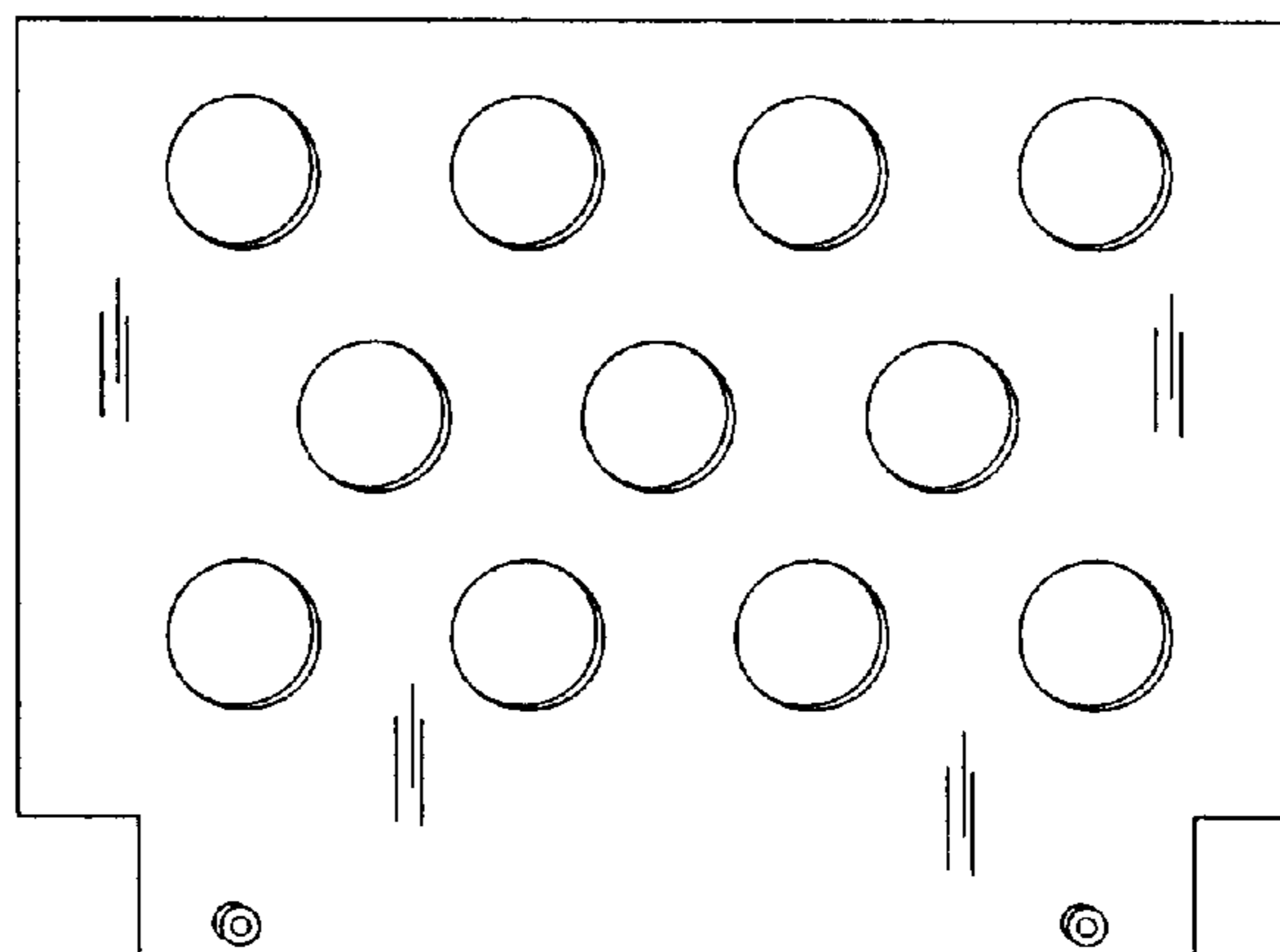
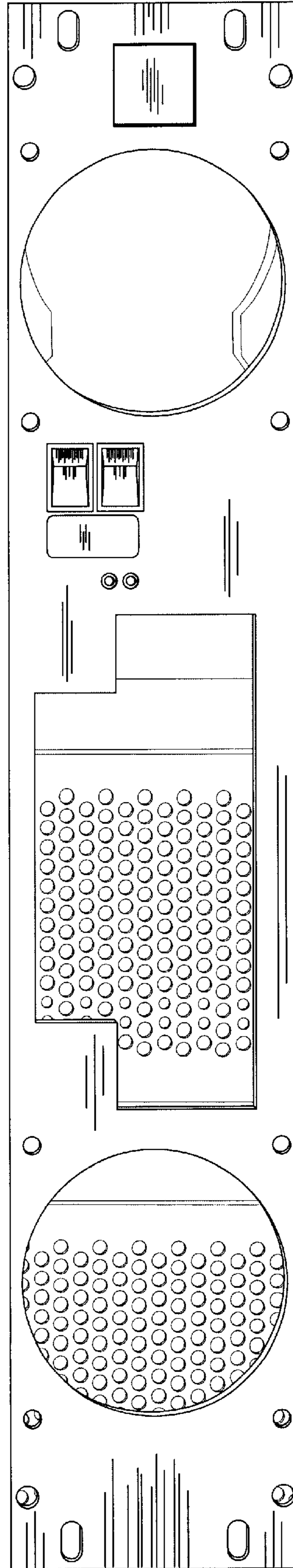
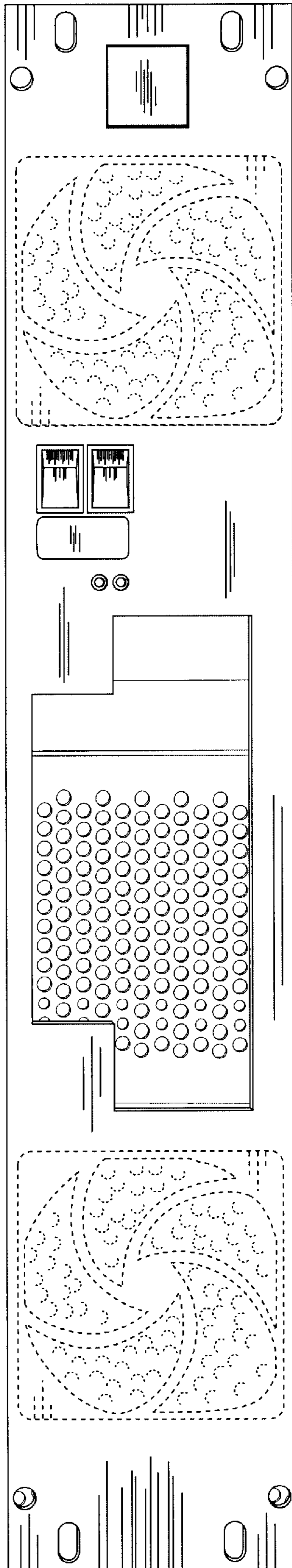

Fig. 4



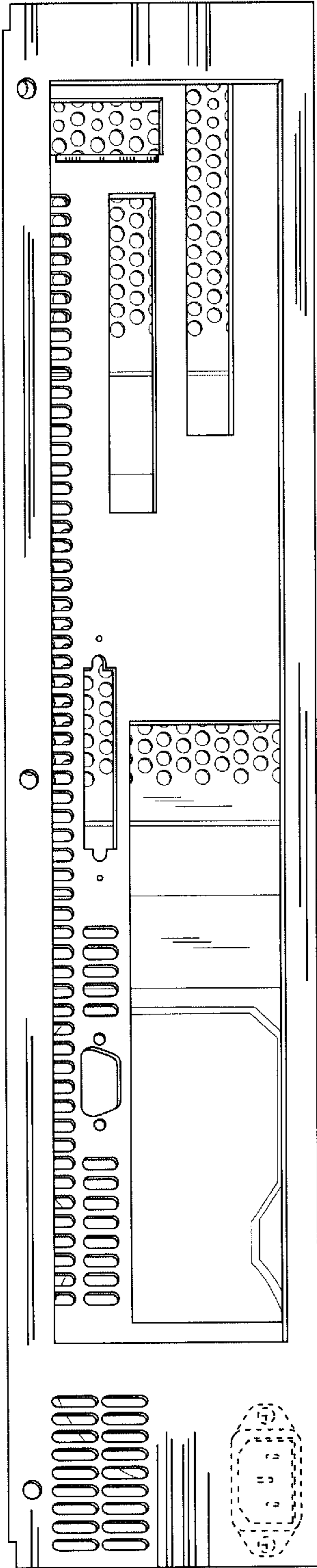

Fig. 7

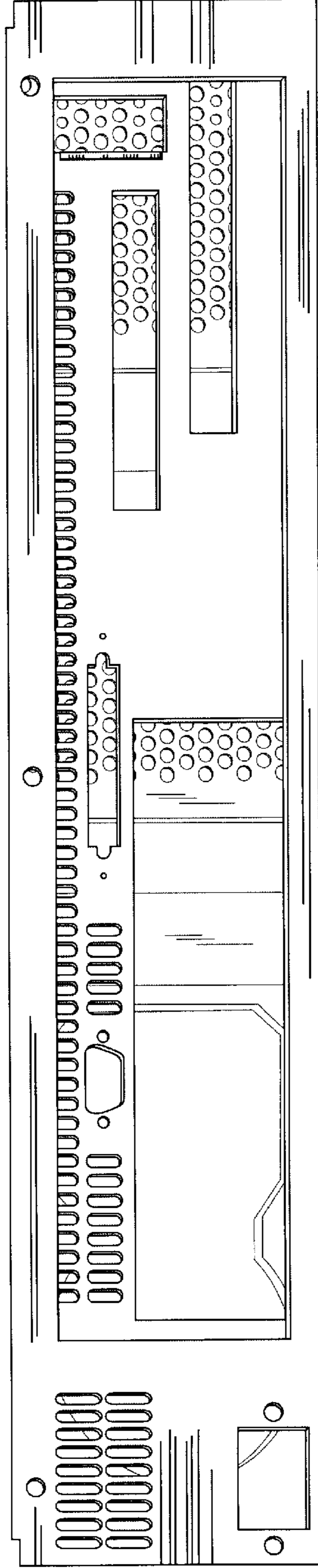

Fig. 8

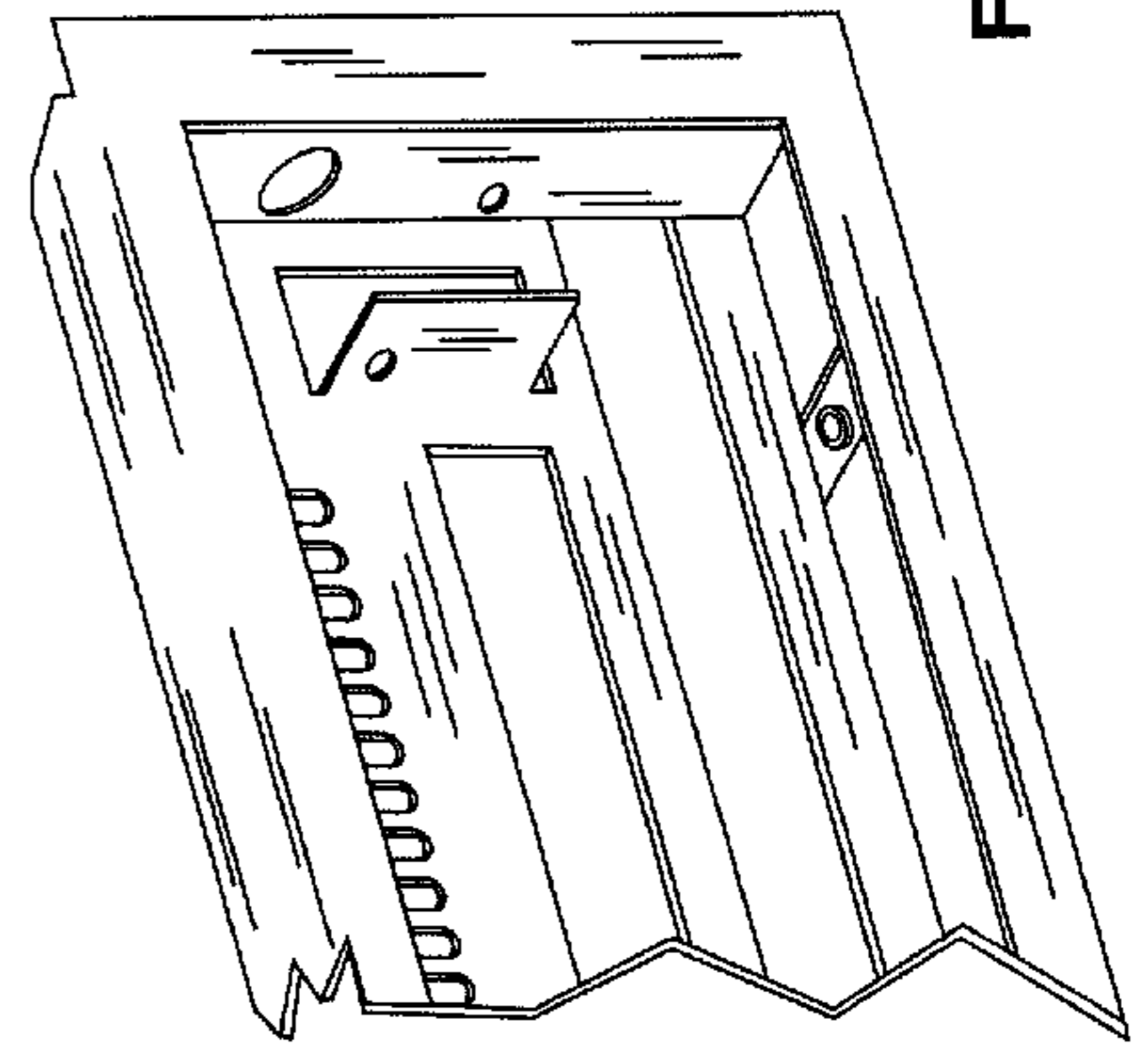

Fig. 9

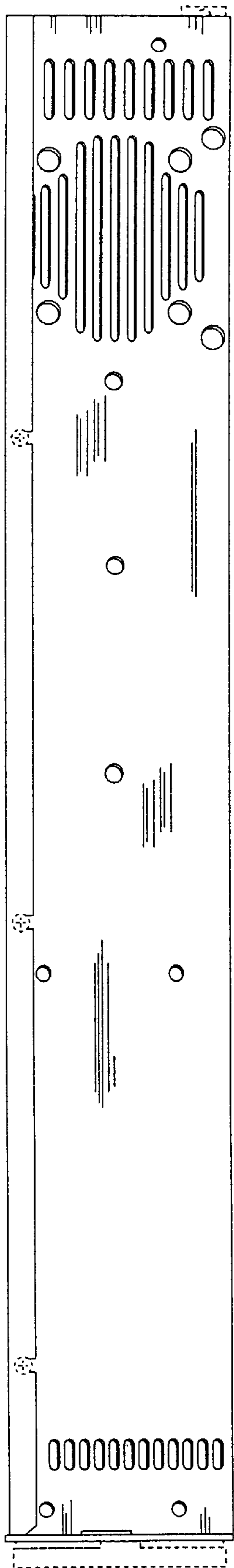

Fig. 10

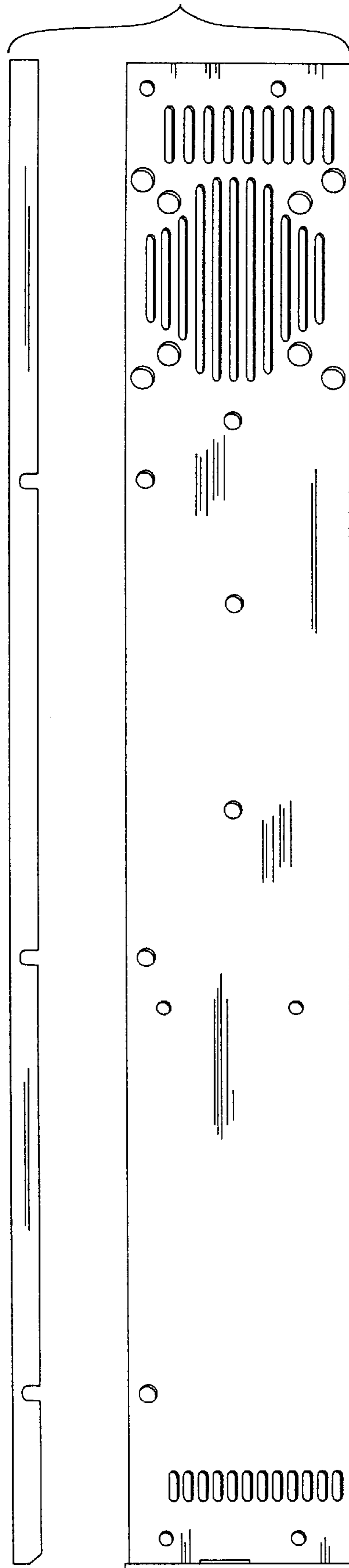

Fig. 11

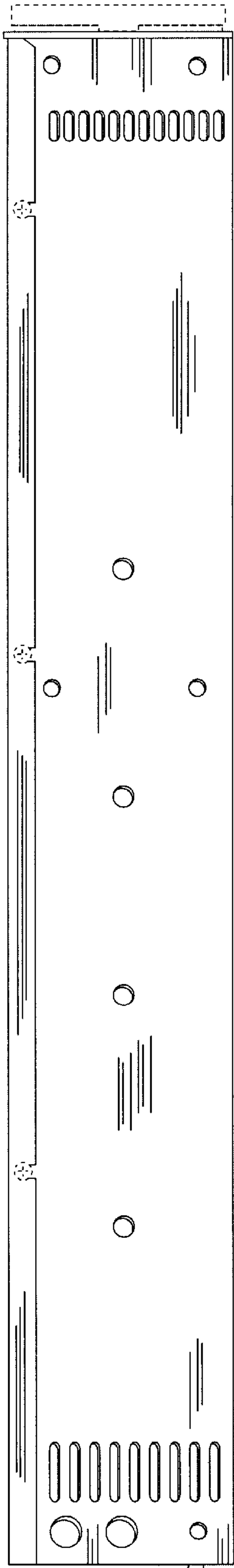

Fig. 12

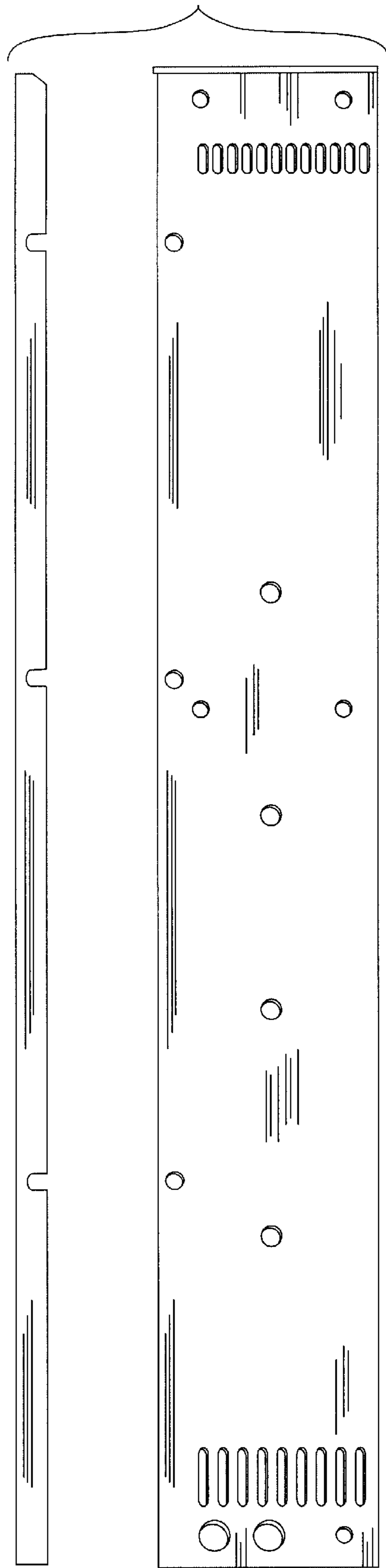

Fig. 13