



US00D455418S

(12) **United States Design Patent**
Schmidt et al.

(10) **Patent No.:** **US D455,418 S**

(45) **Date of Patent:** **** Apr. 9, 2002**

(54) **BASE FOR A HEADSET**

(75) Inventors: **Peter O. Schmidt**, Campbell; **Jeffrey S. Jones**, Los Altos, both of CA (US)

(73) Assignee: **Hello Direct, Inc.**, San Jose, CA (US)

(**) Term: **14 Years**

(21) Appl. No.: **29/138,161**

(22) Filed: **Mar. 7, 2001**

(51) **LOC (7) Cl.** **14-01**

(52) **U.S. Cl.** **D14/224**

(58) **Field of Search** D14/224, 240,
D14/253, 142, 149; D13/108; 379/428,
433-440, 454, 455, 446, 426, 447; 248/224.7,
222.11; 455/90

(56) **References Cited**

U.S. PATENT DOCUMENTS

D252,570 S	*	8/1979	Genaro et al.	D14/149
D302,272 S	*	7/1989	Sharp, Jr.	D14/142
D315,161 S		3/1991	Watanabe	D14/253
D315,352 S		3/1991	Langton	D14/251
D319,440 S		8/1991	Soren	D14/142
D321,510 S		11/1991	Langlois	D14/151
D324,217 S		2/1992	Suckley	D14/148
5,253,292 A	*	10/1993	Fluder et al.	379/446

D343,841 S		2/1994	Hon et al.	D14/251
D360,723 S	*	7/1995	Kasai et al.	D13/108
D362,004 S	*	9/1995	Nakano et al.	D14/253
5,517,683 A	*	5/1996	Collett et al.	379/450
5,535,274 A	*	7/1996	Braitberg et al.	379/426
D386,176 S		11/1997	Diamantis et al.	D14/149
5,745,566 A	*	4/1998	Petrella et al.	379/434
5,745,579 A	*	4/1998	Newman	379/447
D398,927 S		9/1998	Read et al.	D14/149
D406,848 S		3/1999	Salmi	D14/240
D409,999 S		5/1999	Nuovo et al.	D14/138

* cited by examiner

Primary Examiner—Prabhakar Deshmukh

(74) *Attorney, Agent, or Firm*—Haverstock & Owens LLP

(57) **CLAIM**

We claim the ornamental design for a base for a headset, as shown and described.

DESCRIPTION

FIG. 1 is a perspective view of a base for a headset;
FIG. 2 is a front view of the base for a headset thereof;
FIG. 3 is a top view of the base for a headset thereof;
FIG. 4 is a side view of the base for a headset thereof;
FIG. 5 is a side view of the base for a headset thereof;
FIG. 6 is a back view of the base for a headset thereof; and,
FIG. 7 is a bottom view of the base for a headset thereof.

1 Claim, 4 Drawing Sheets

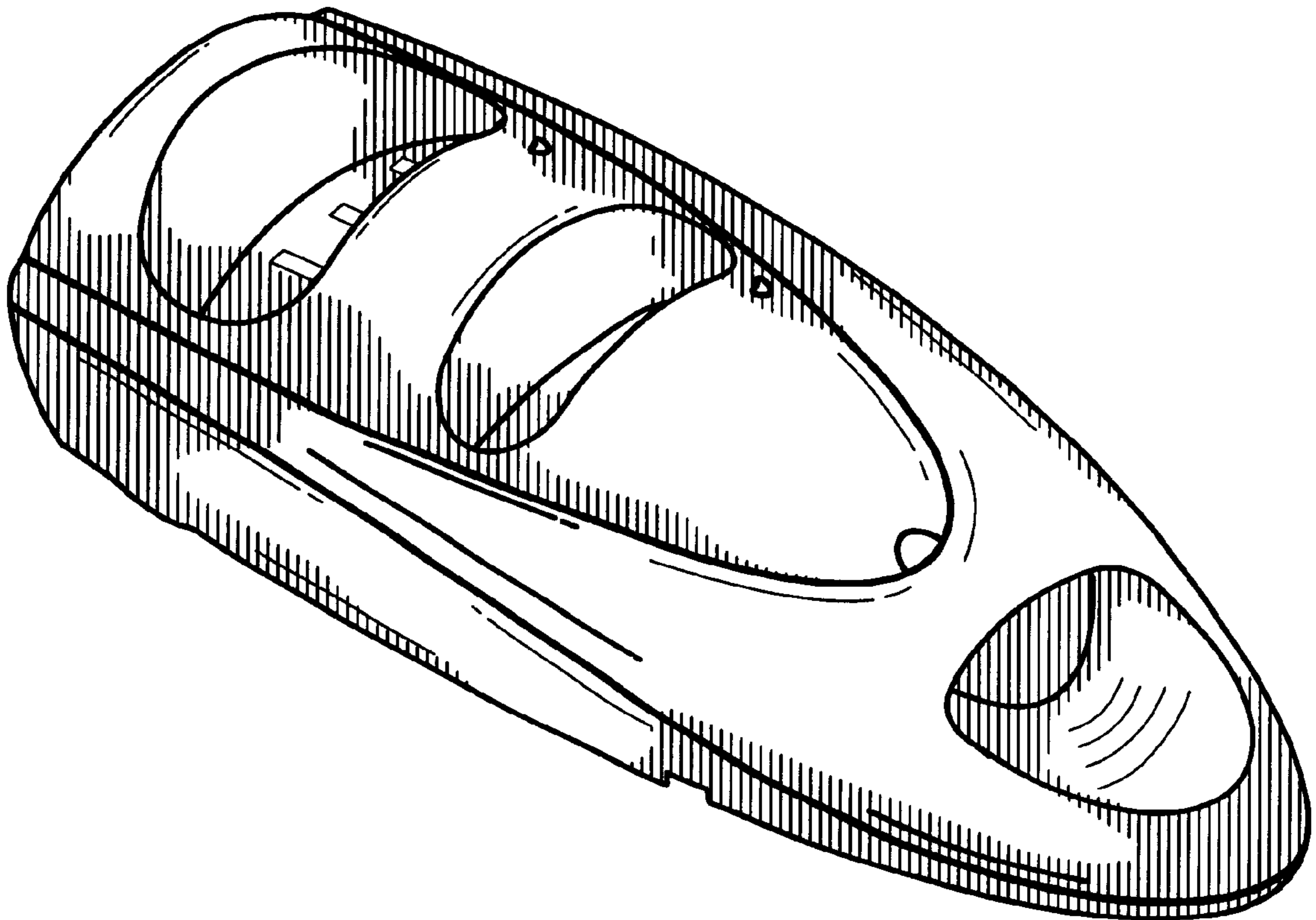

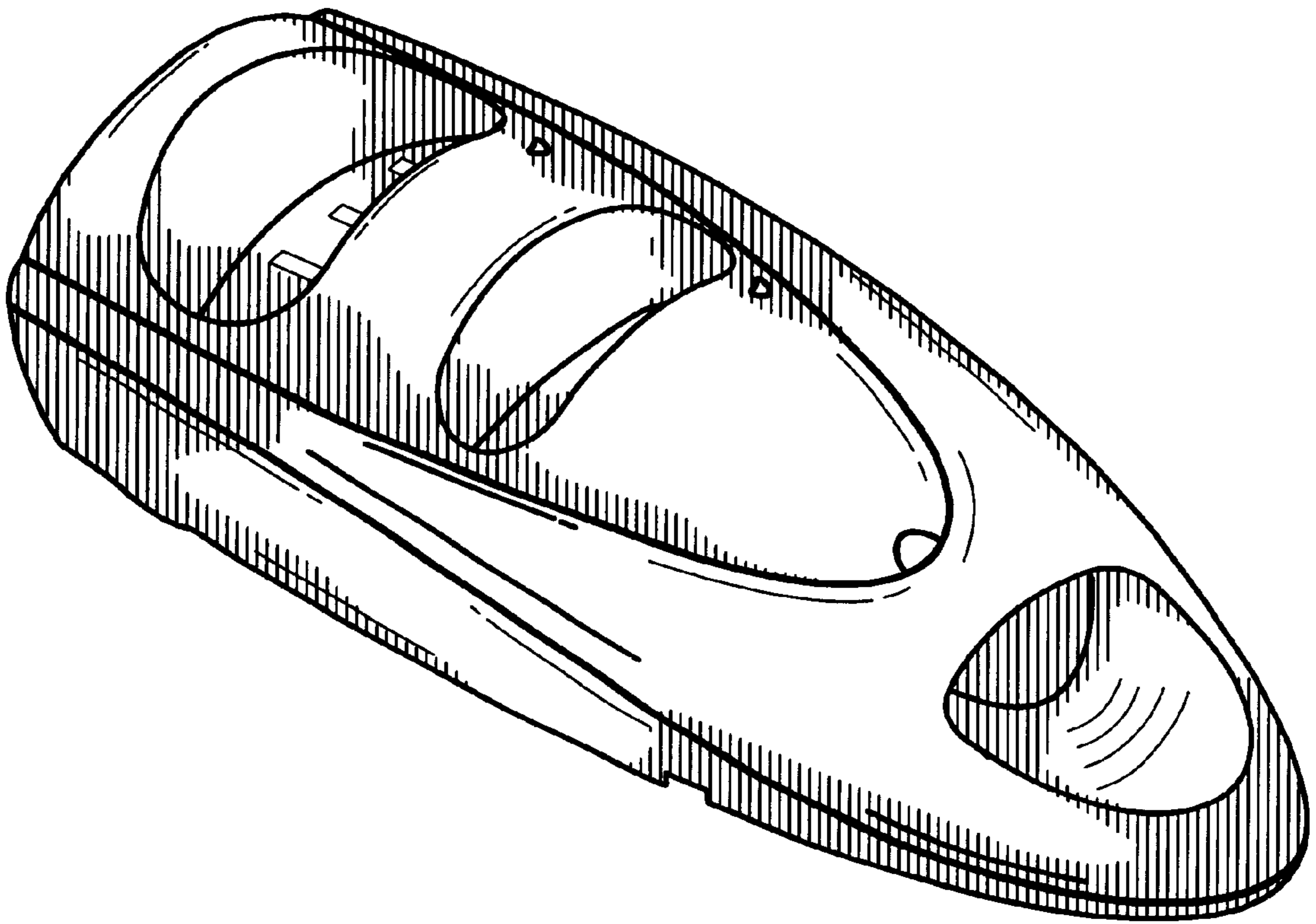

Fig. 1

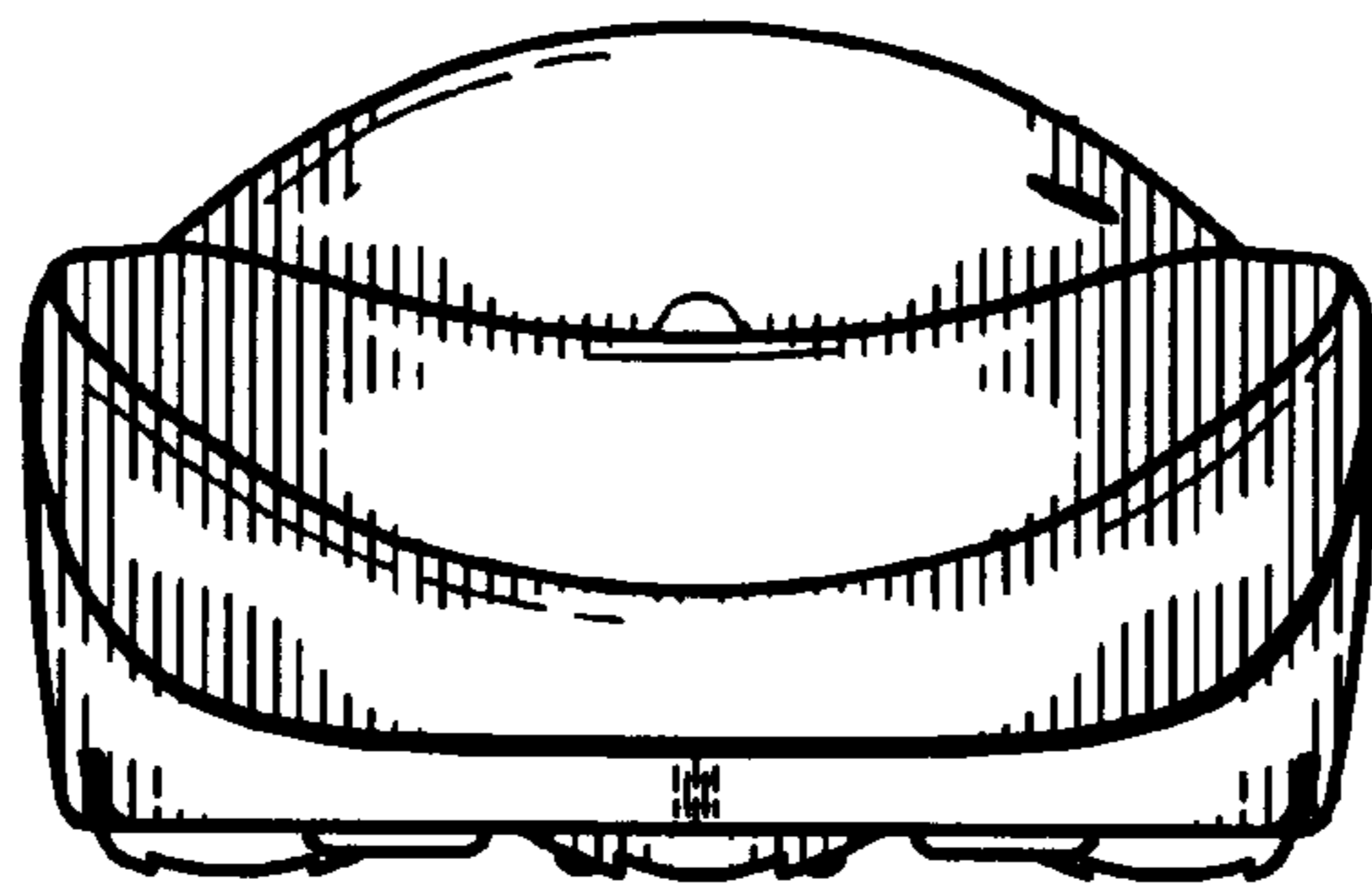

Fig. 2

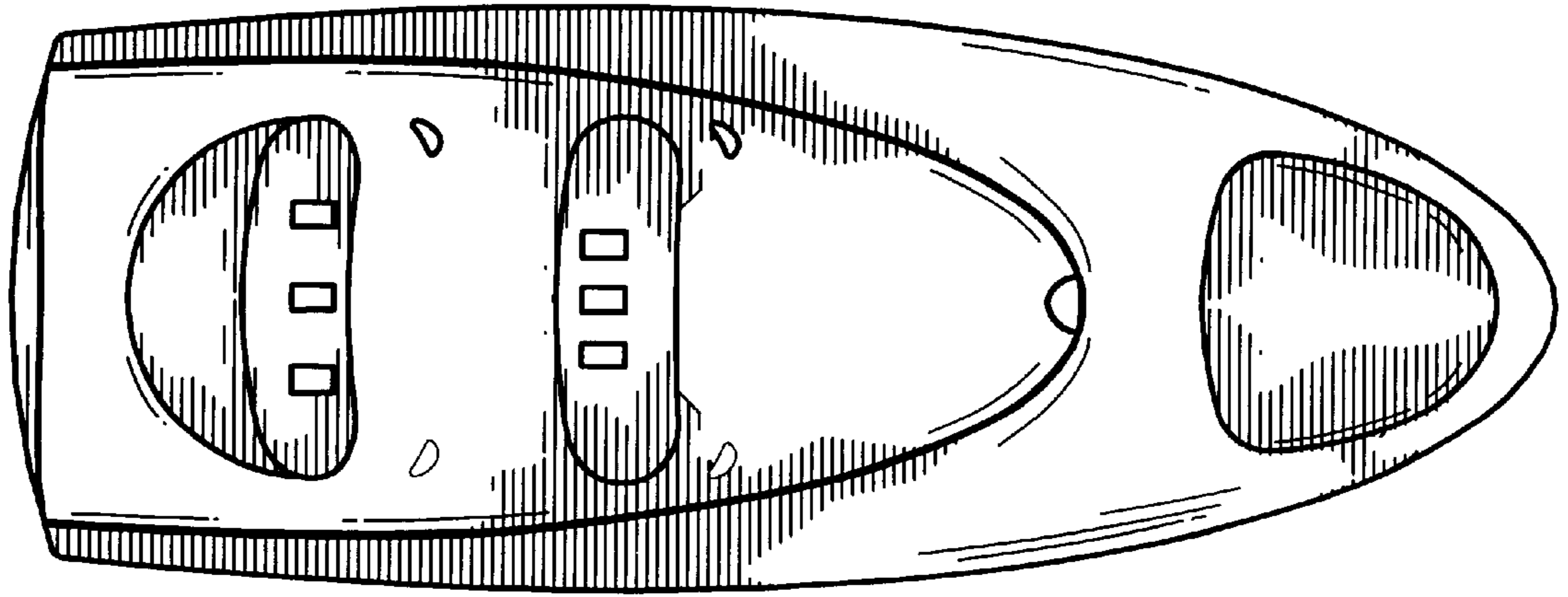

Fig. 3

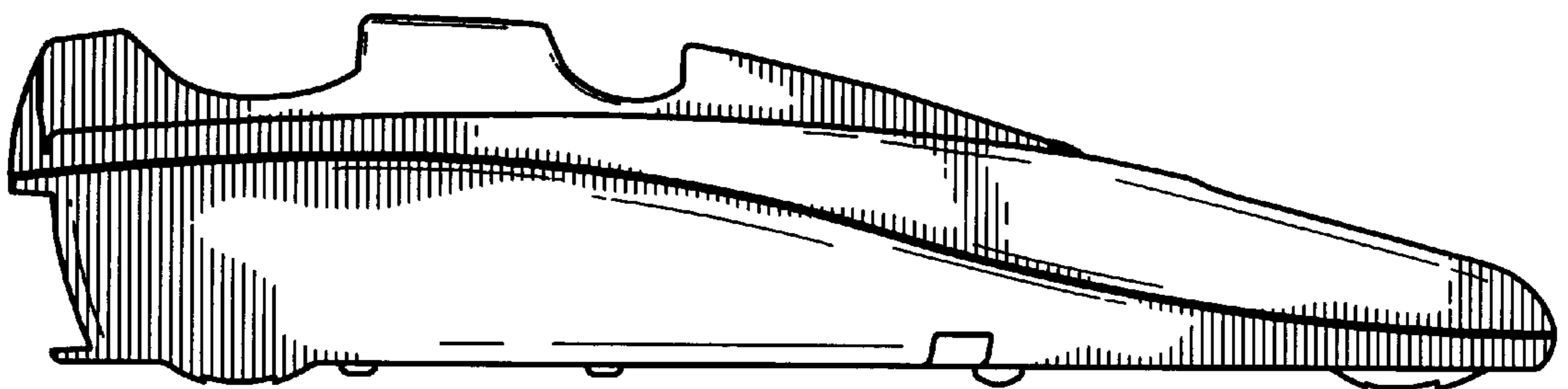

Fig. 4

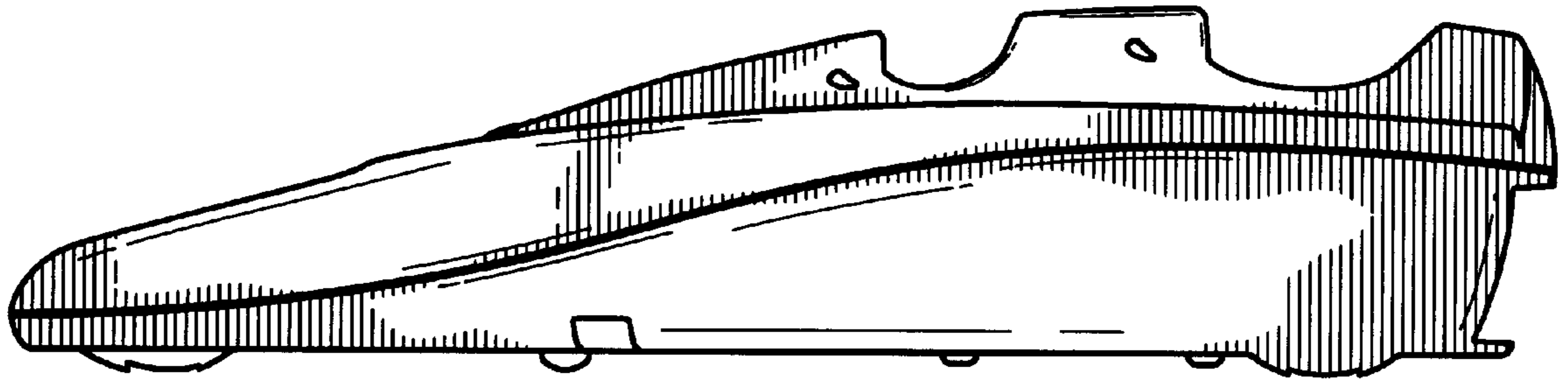

Fig. 5

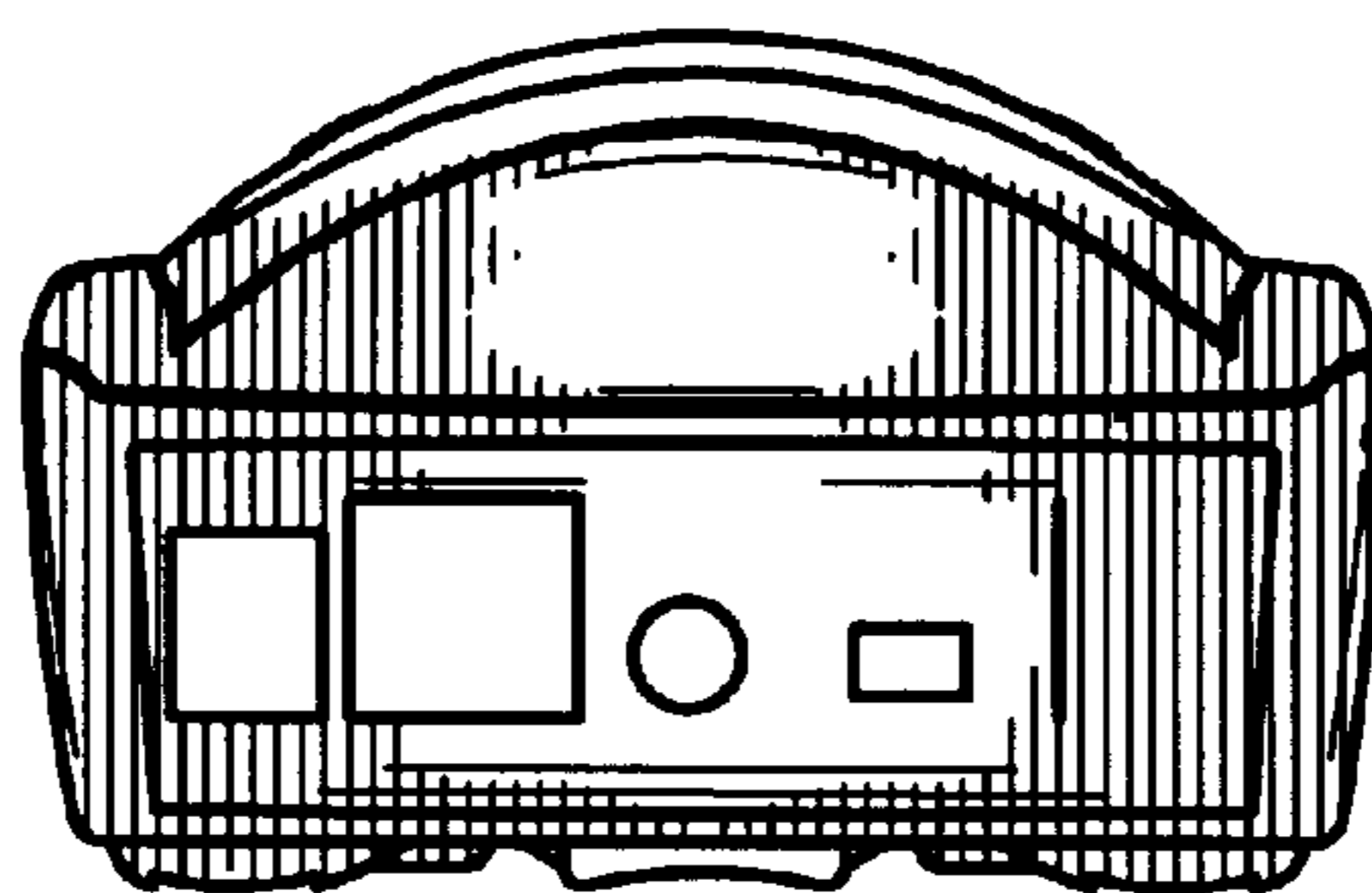

Fig. 6

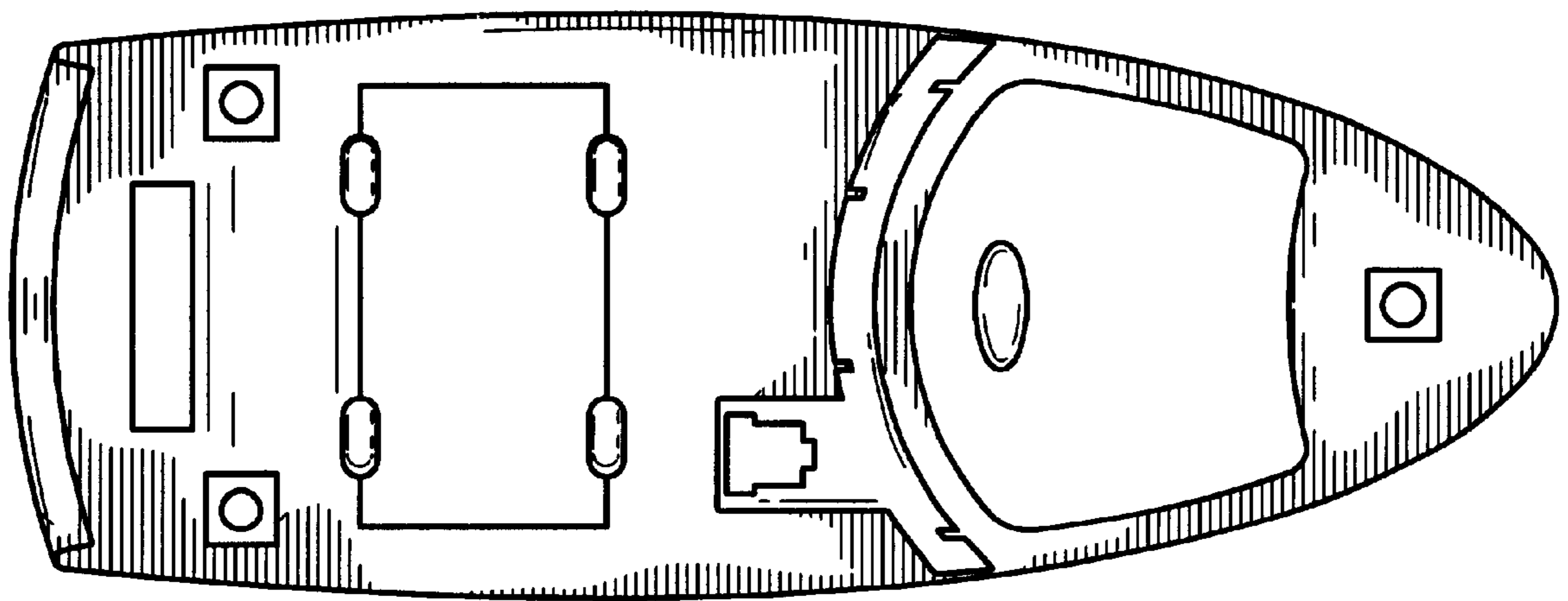

Fig. 7