



US00D455407S

(12) **United States Design Patent** (10) **Patent No.:** **US D455,407 S**
Hanzlik et al. (45) **Date of Patent:** **** Apr. 9, 2002**

(54) **COOLING DEVICE**

(75) Inventors: **Steven E Hanzlik; Michael A Hansen,**
both of Fort Collins; **Guy R Wagner,**
Loveland; **Arlen L Roesner,** Fort
Collins, all of CO (US)

(73) Assignee: **Agilent Technologies, Inc.,** Palo Alto,
CA (US)

(**) Term: **14 Years**

(21) Appl. No.: **29/130,200**

(22) Filed: **Sep. 28, 2000**

Related U.S. Application Data

(63) Continuation of application No. 29/118,454, filed on Feb. 7,
2000.

(51) **LOC (7) Cl.** **13-03**

(52) **U.S. Cl.** **D13/179**

(58) **Field of Search** D13/179; 174/163;
361/704, 705, 709; 257/718, 719

(56) **References Cited**

U.S. PATENT DOCUMENTS

D203,454 S	*	1/1966	Cox	D13/179
D287,120 S	*	12/1986	McCarthy	D13/179
D367,469 S	*	2/1996	Widmayer et al.	D13/179
D388,399 S	*	12/1997	Widmayer et al.	D13/179
D398,589 S	*	9/1998	Dodson	D13/179

* cited by examiner

Primary Examiner—Brian N. Vinson

(57) **CLAIM**

The ornamental design for a cooling device, as shown and
described.

DESCRIPTION

FIG. 1 is a top, left, front perspective view of a first
embodiment of a cooling device showing our new design;

FIG. 2 is a top plan view of the first embodiment;
 FIG. 3 is a bottom view of the first embodiment;
 FIG. 4 is a front elevation view of the first embodiment;
 FIG. 5 is a rear elevation view of the first embodiment;
 FIG. 6 is a right elevation view of the first embodiment;
 FIG. 7 is a left elevation view of the first embodiment;
 FIG. 8 is a top, right, front perspective view of a second
 embodiment of a cooling device showing our new design;
 FIG. 9 is a top plan view of the second embodiment;
 FIG. 10 is a bottom view of the second embodiment;
 FIG. 11 is a front elevation view of the second embodiment;
 FIG. 12 is a rear elevation view of the second embodiment;
 FIG. 13 is a right elevation view of the second embodiment;
 FIG. 14 is a left elevation view of the second embodiment;
 FIG. 15 is a top, front, left perspective view of a third
 embodiment of a cooling device showing our new design;
 FIG. 16 is a top plan view of the third embodiment;
 FIG. 17 is a bottom view of the third embodiment;
 FIG. 18 is a front elevation view of the third embodiment;
 FIG. 19 is a rear elevation view of the third embodiment;
 FIG. 20 is a right elevation view of the third embodiment;
 FIG. 21 is a left elevation view of the third embodiment;
 FIG. 22 is a top, front, right perspective view of a fourth
 embodiment of a cooling device showing our new design;
 FIG. 23 is a top plan view of the fourth embodiment;
 FIG. 24 is a bottom view of the fourth embodiment;
 FIG. 25 is a front elevation view of the fourth embodiment;
 FIG. 26 is a rear elevation view of the fourth embodiment;
 FIG. 27 is a right elevation view of the fourth embodiment;
 and,
 FIG. 28 is a left elevation view of the fourth embodiment.

1 Claim, 20 Drawing Sheets

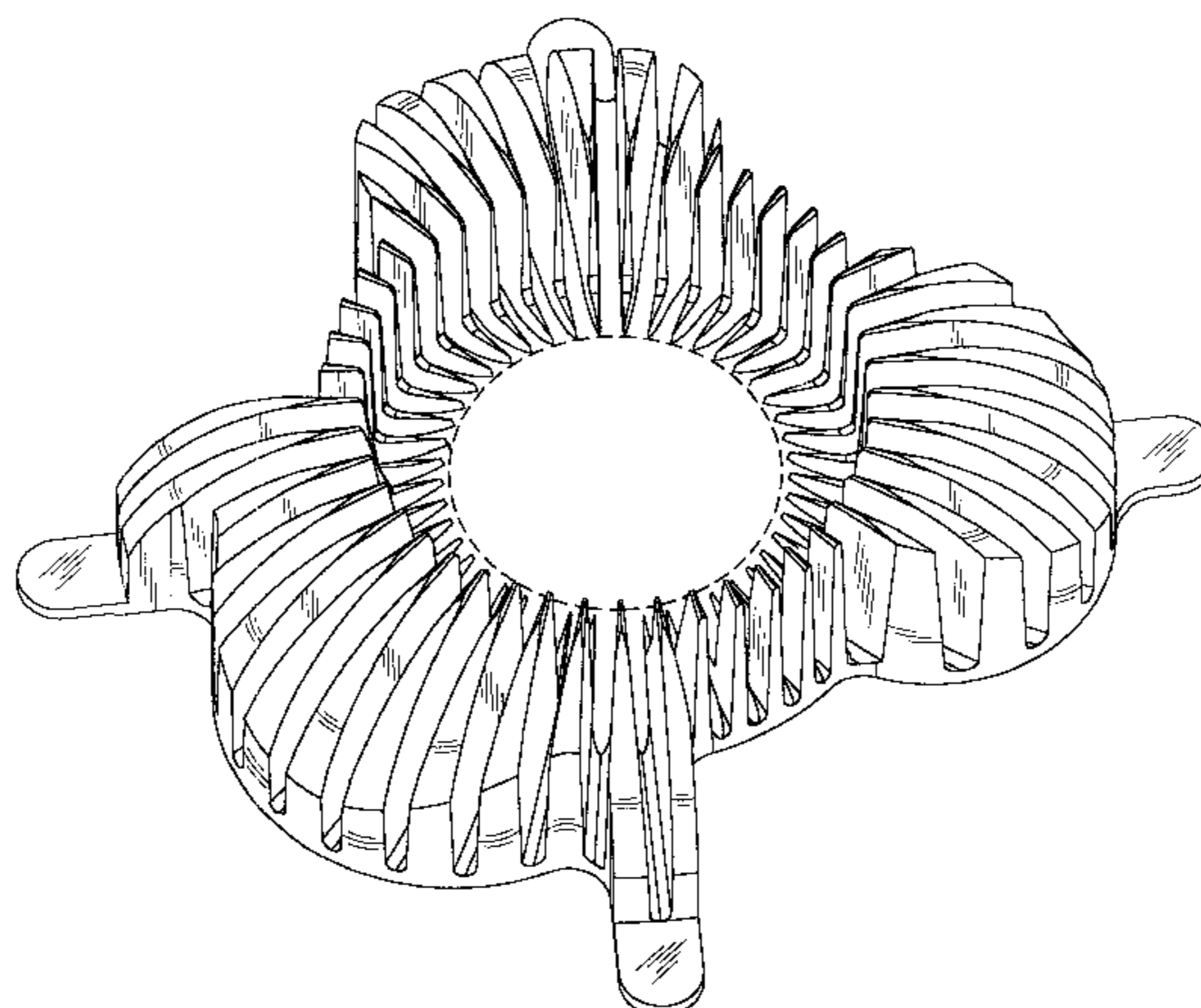

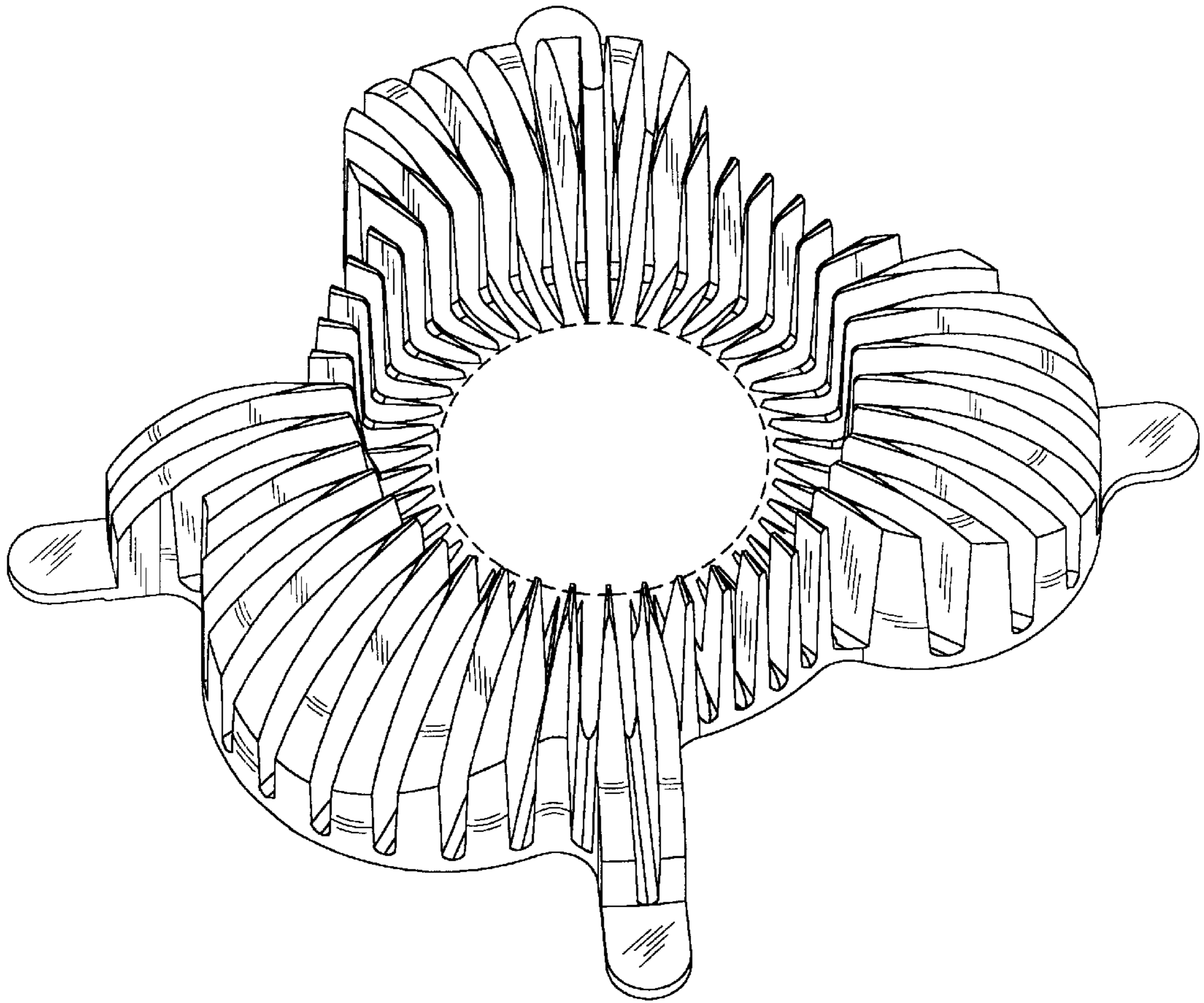

FIG. 1

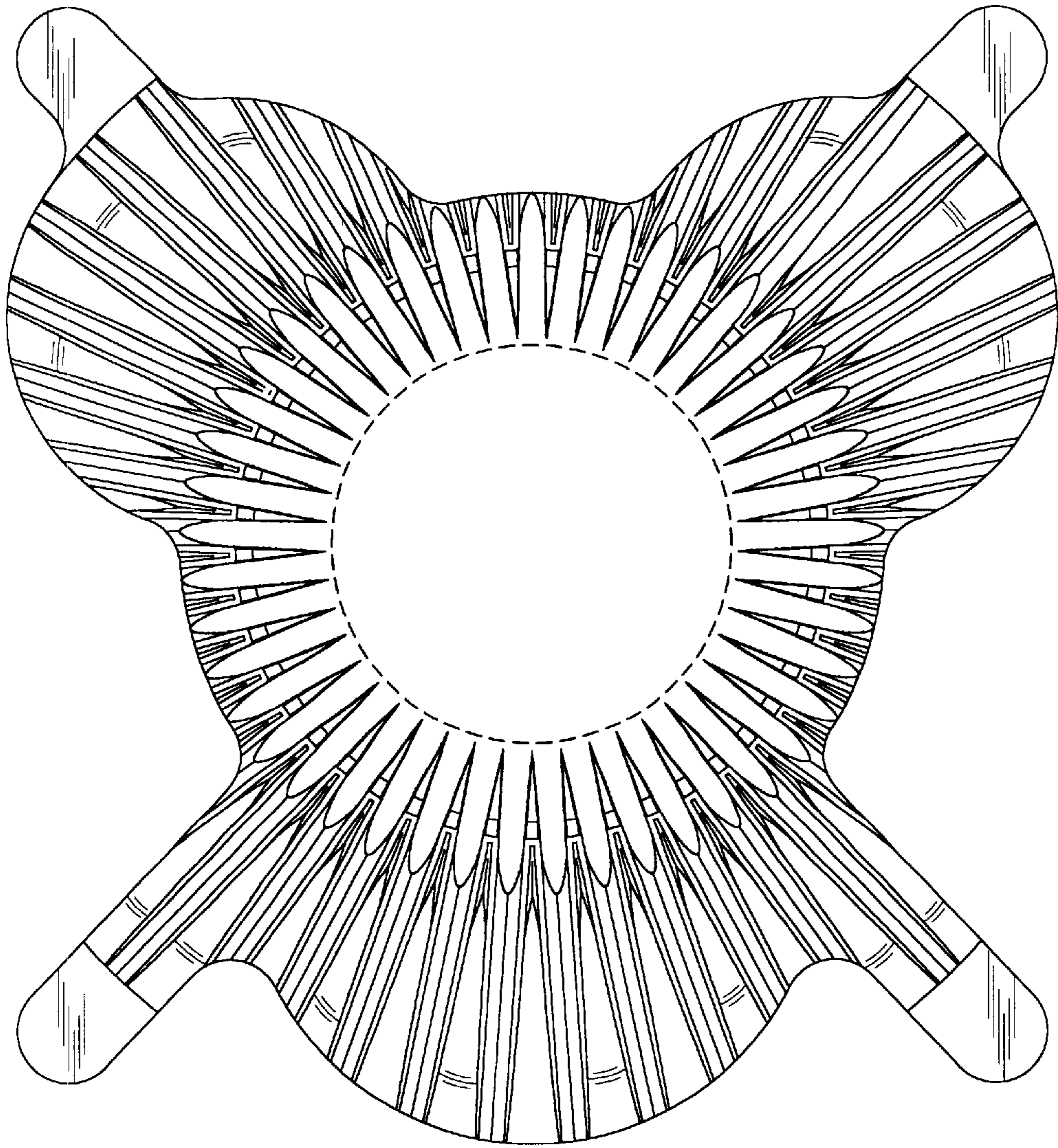

FIG. 2

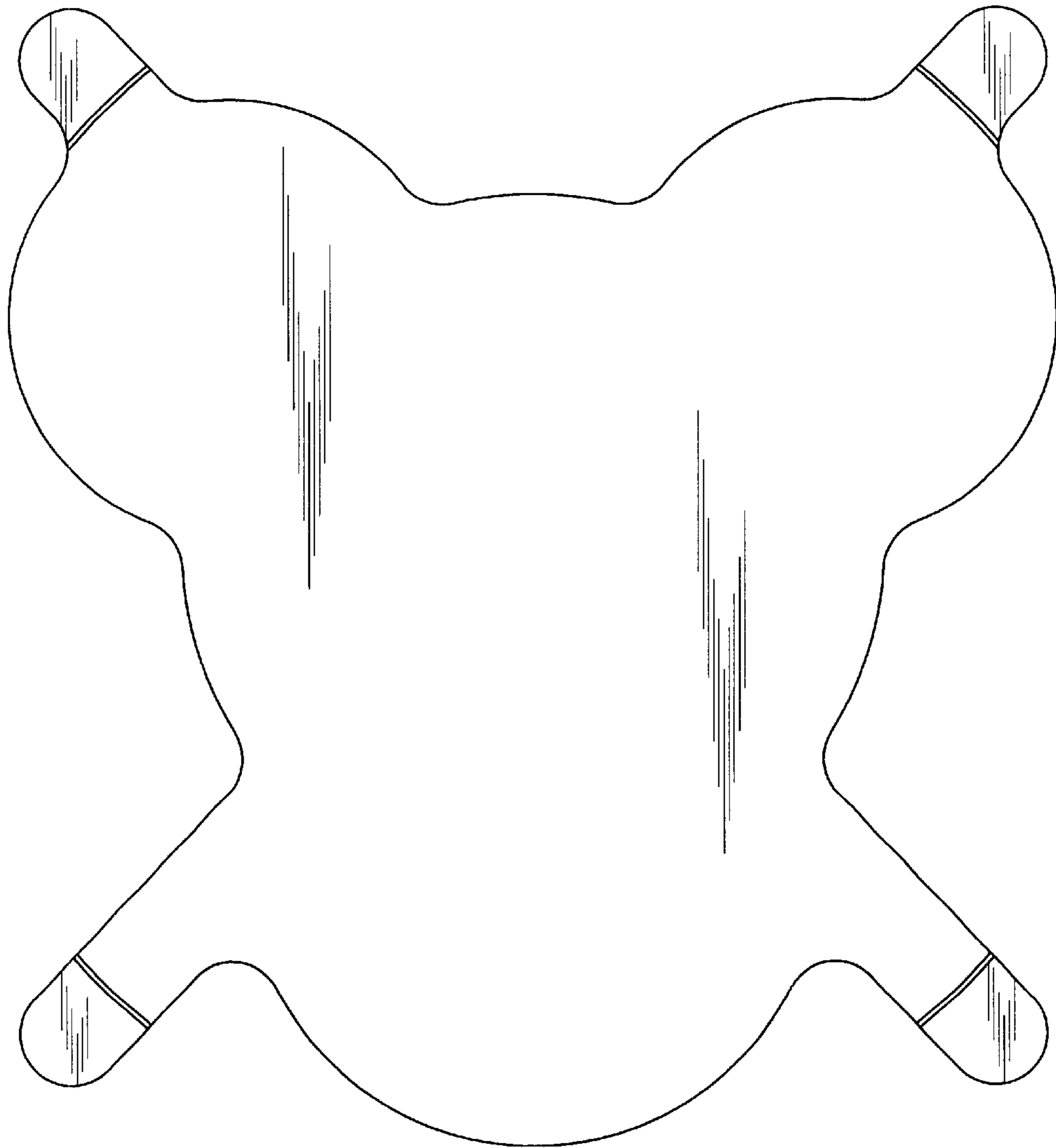

FIG. 3

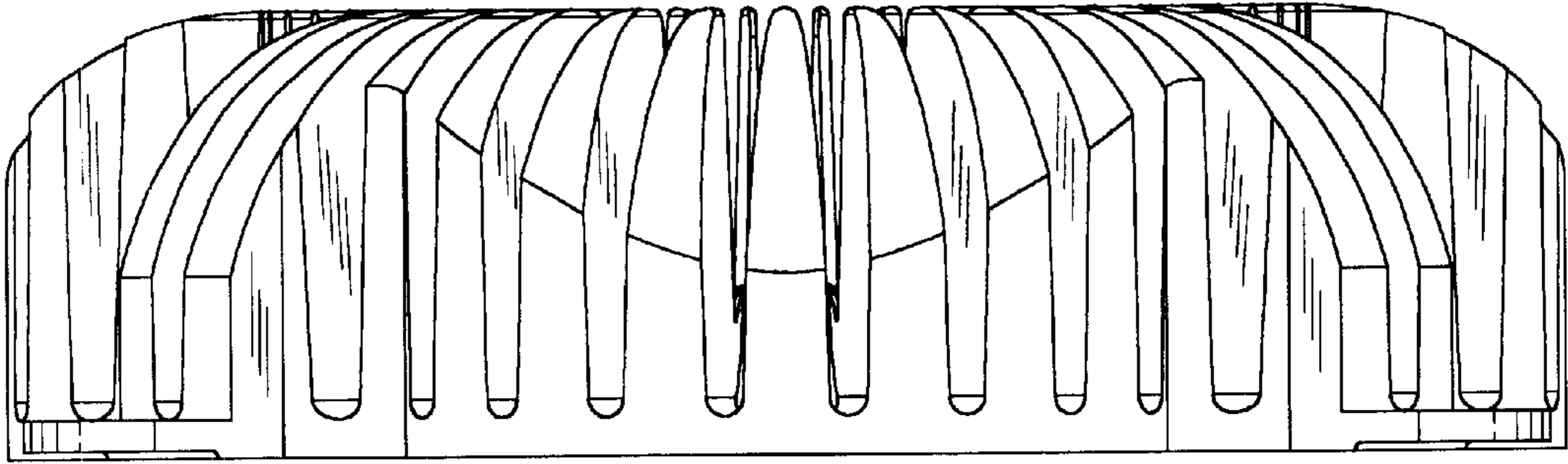

FIG. 4

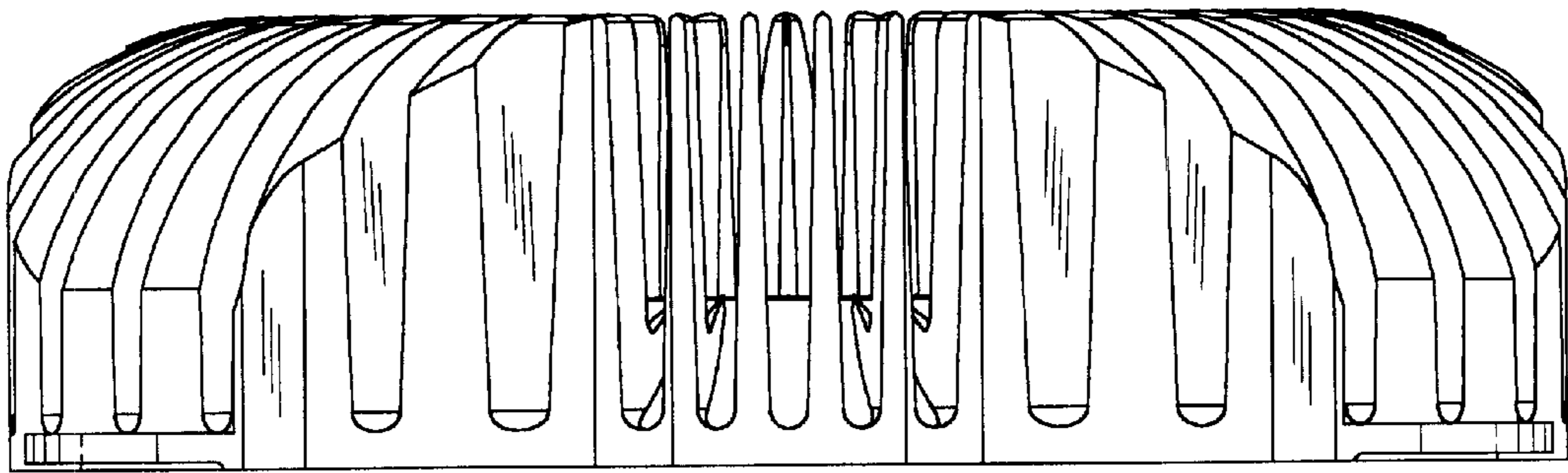

FIG. 5

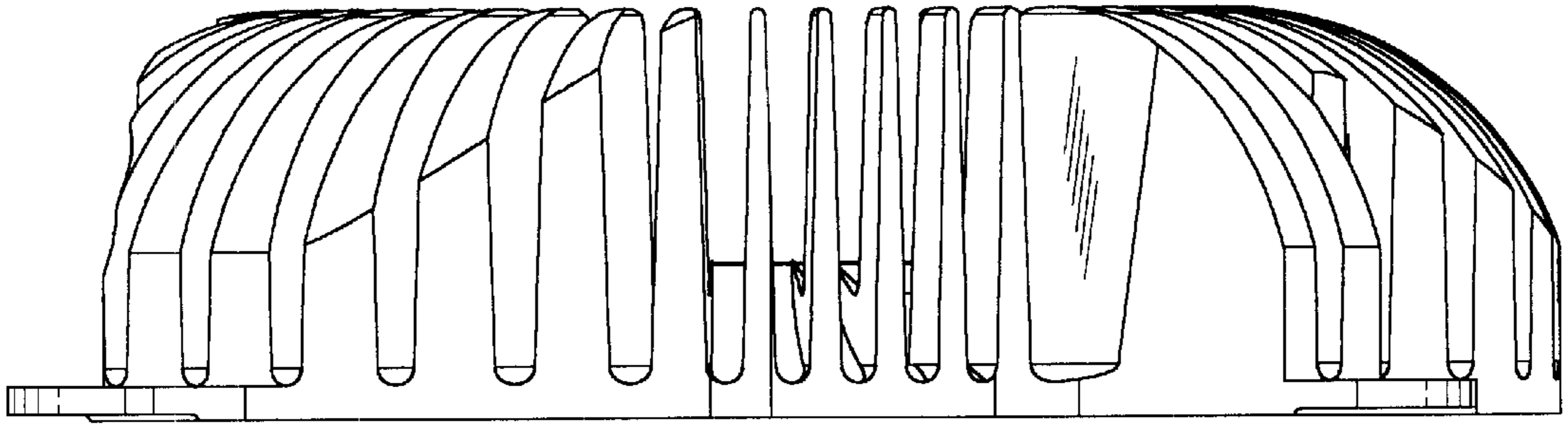

FIG. 6

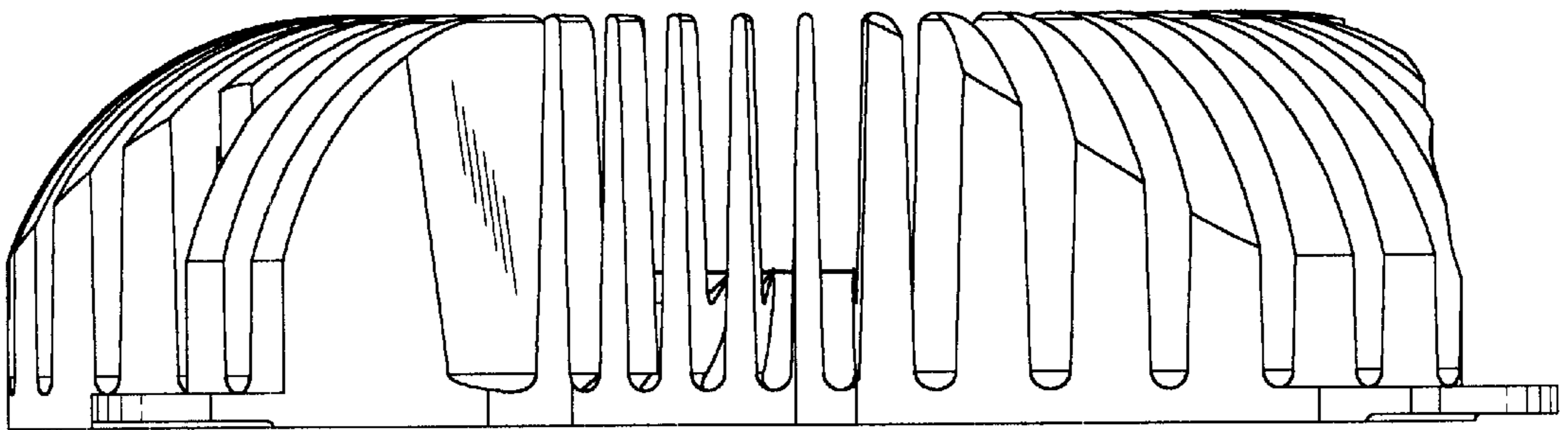

FIG. 7

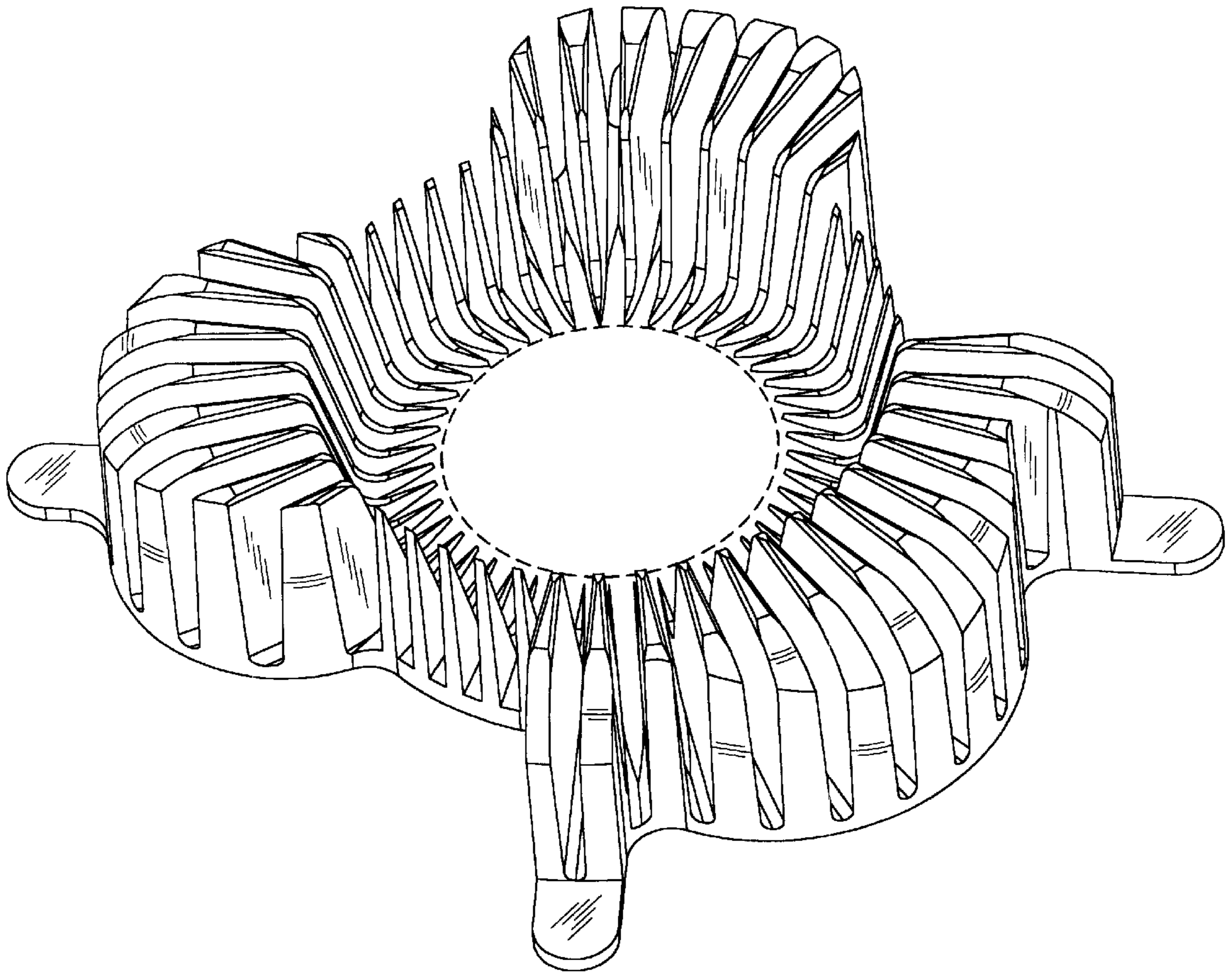

FIG. 8

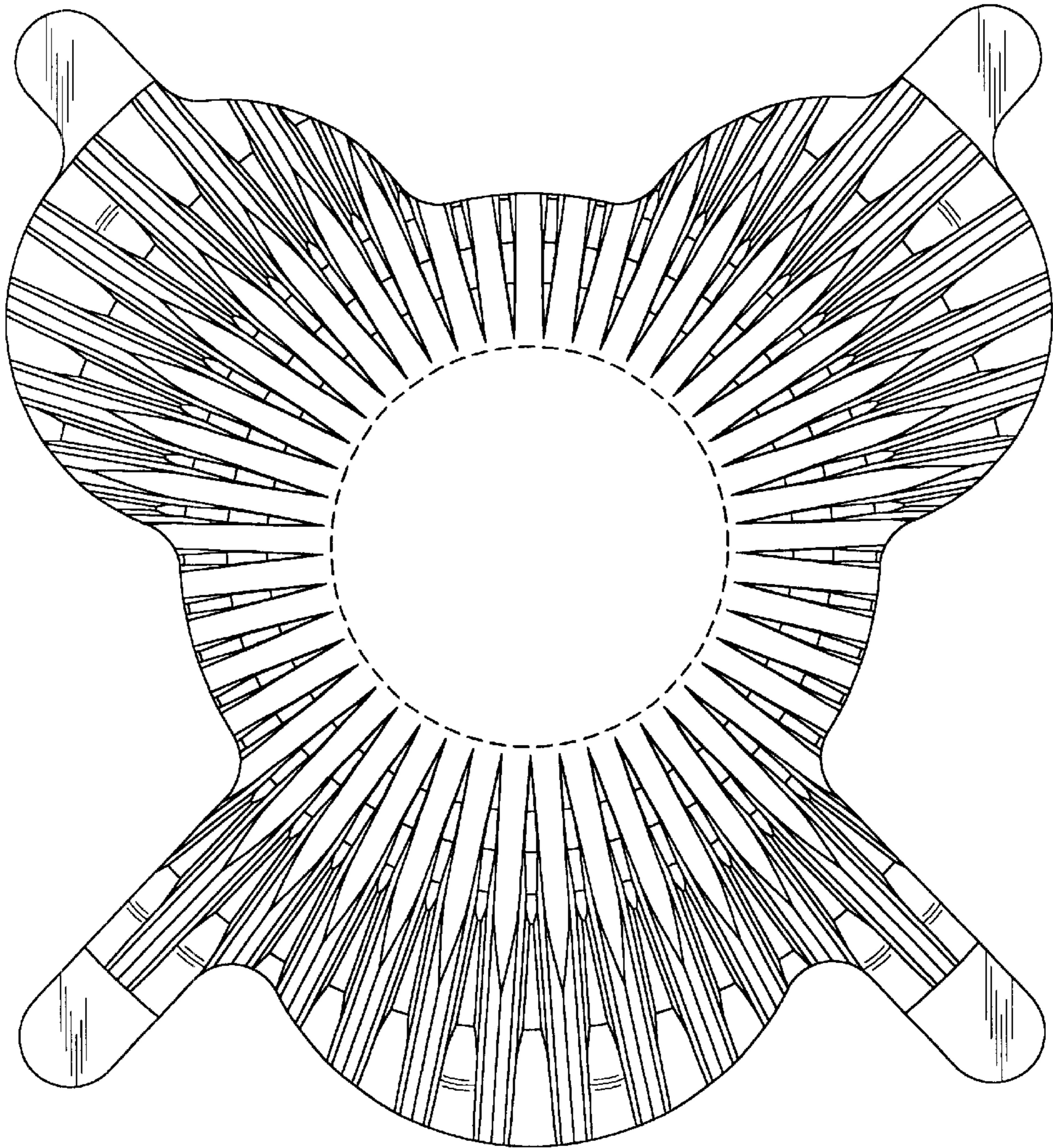

FIG. 9

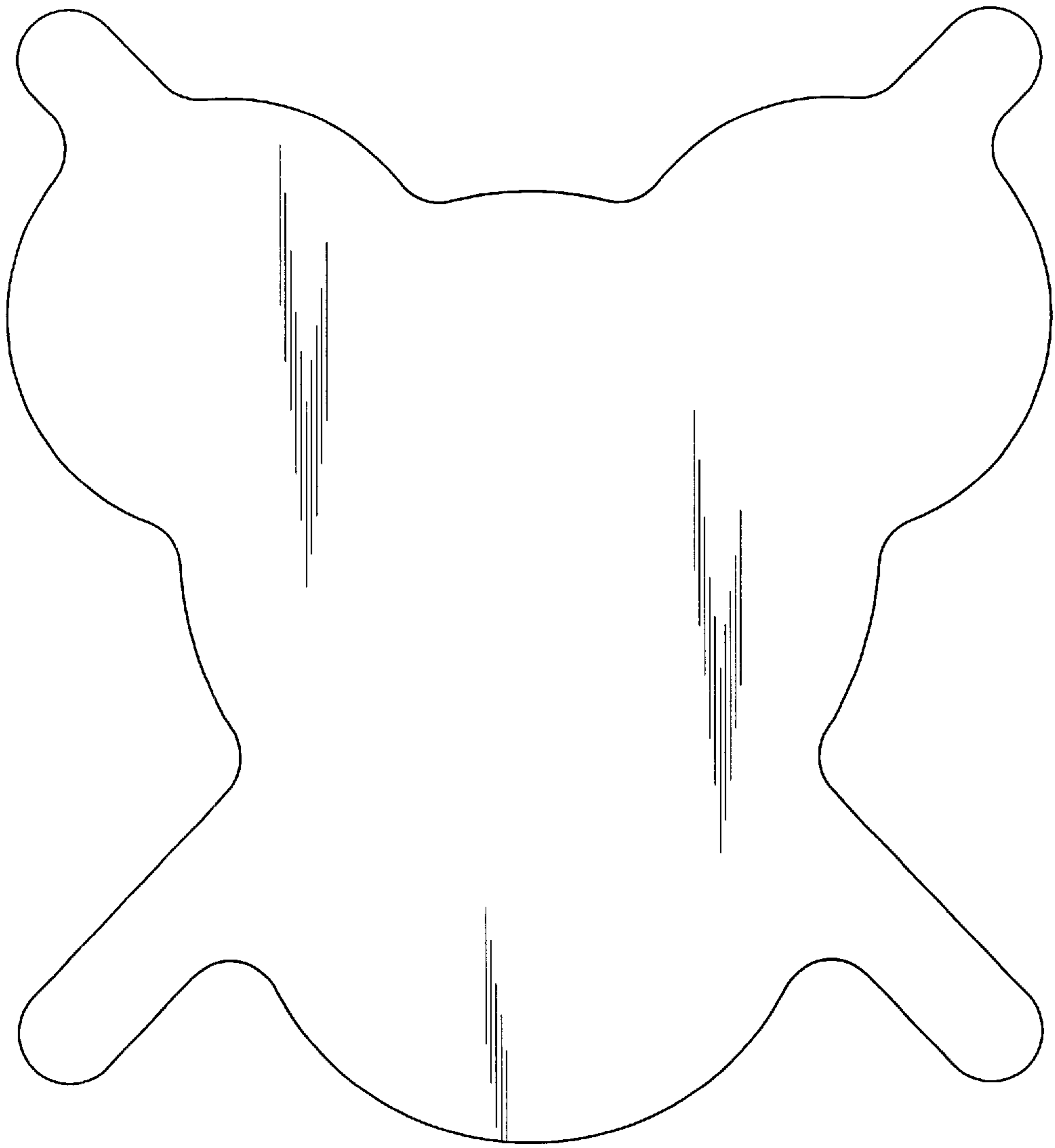

FIG. 10

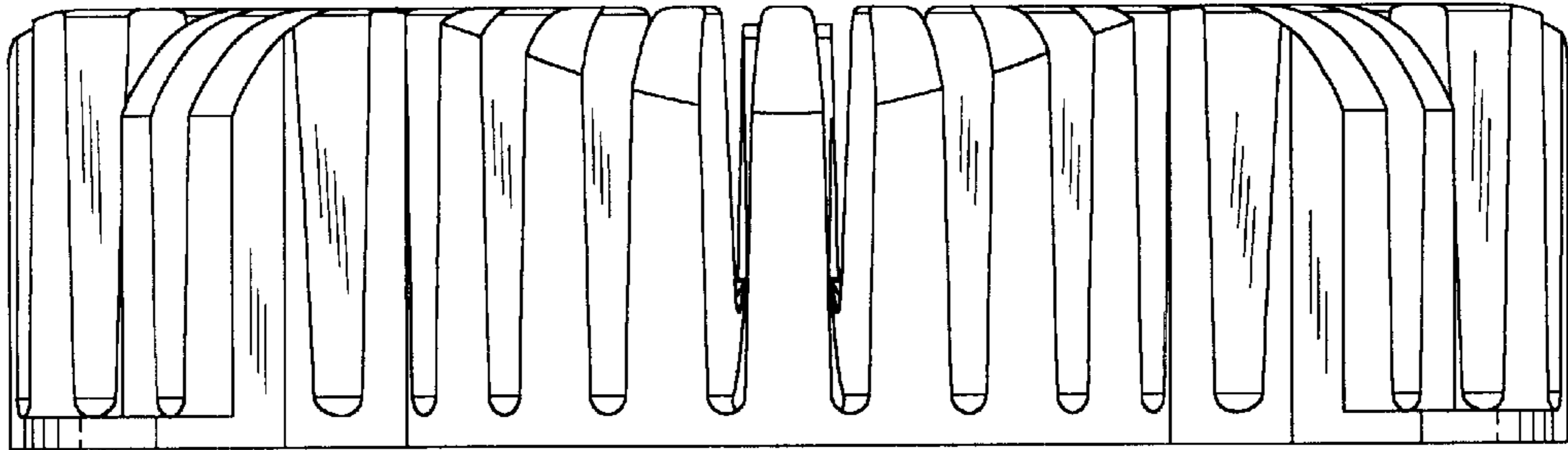

FIG. 11

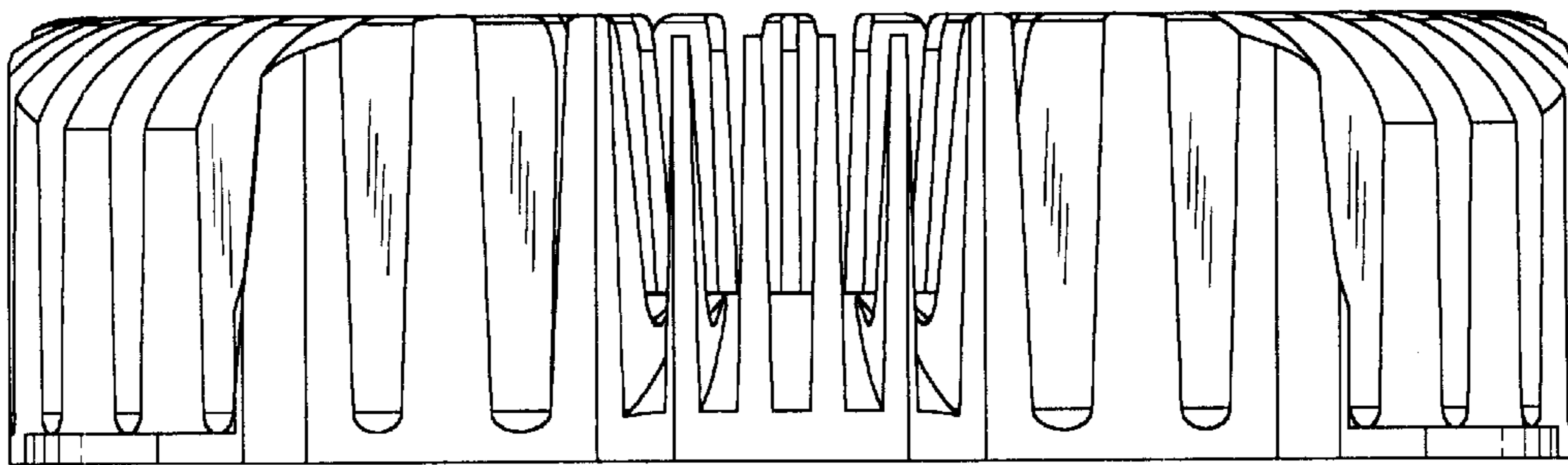

FIG. 12

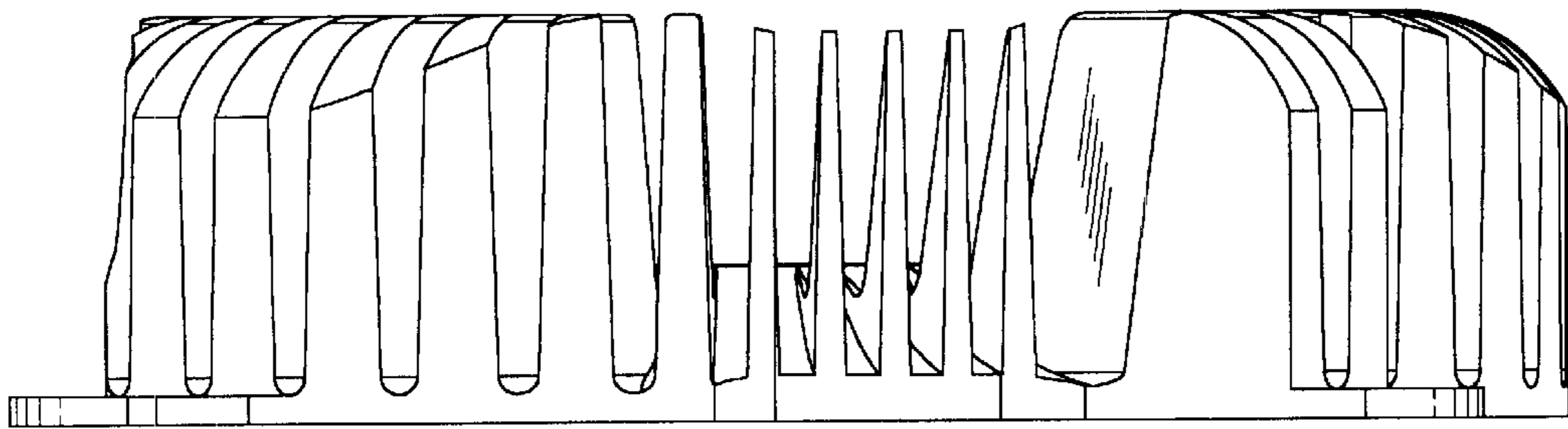

FIG. 13

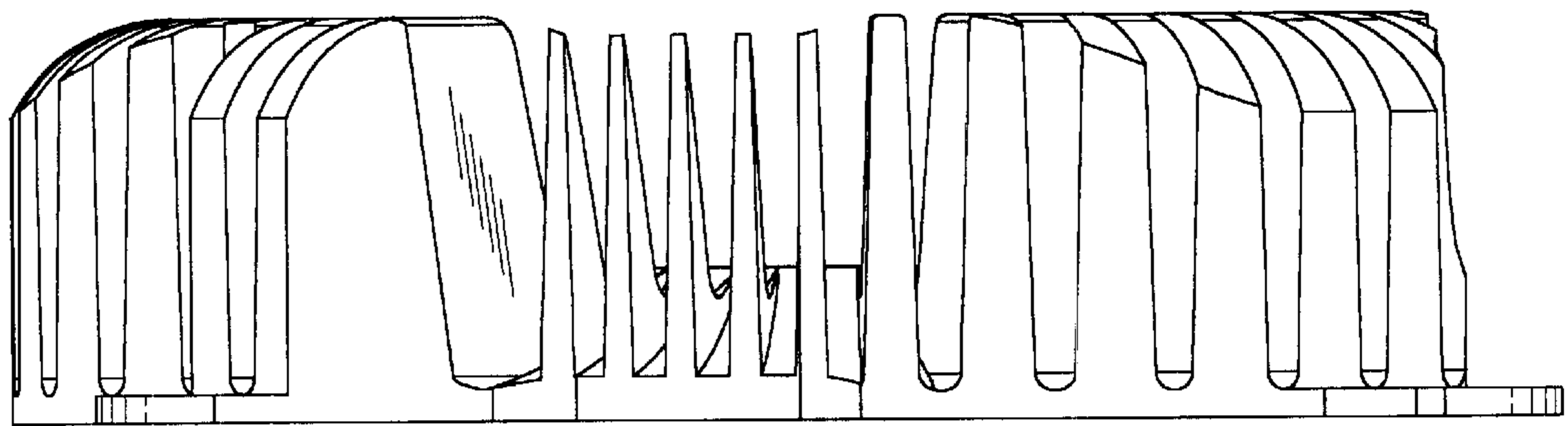

FIG. 14

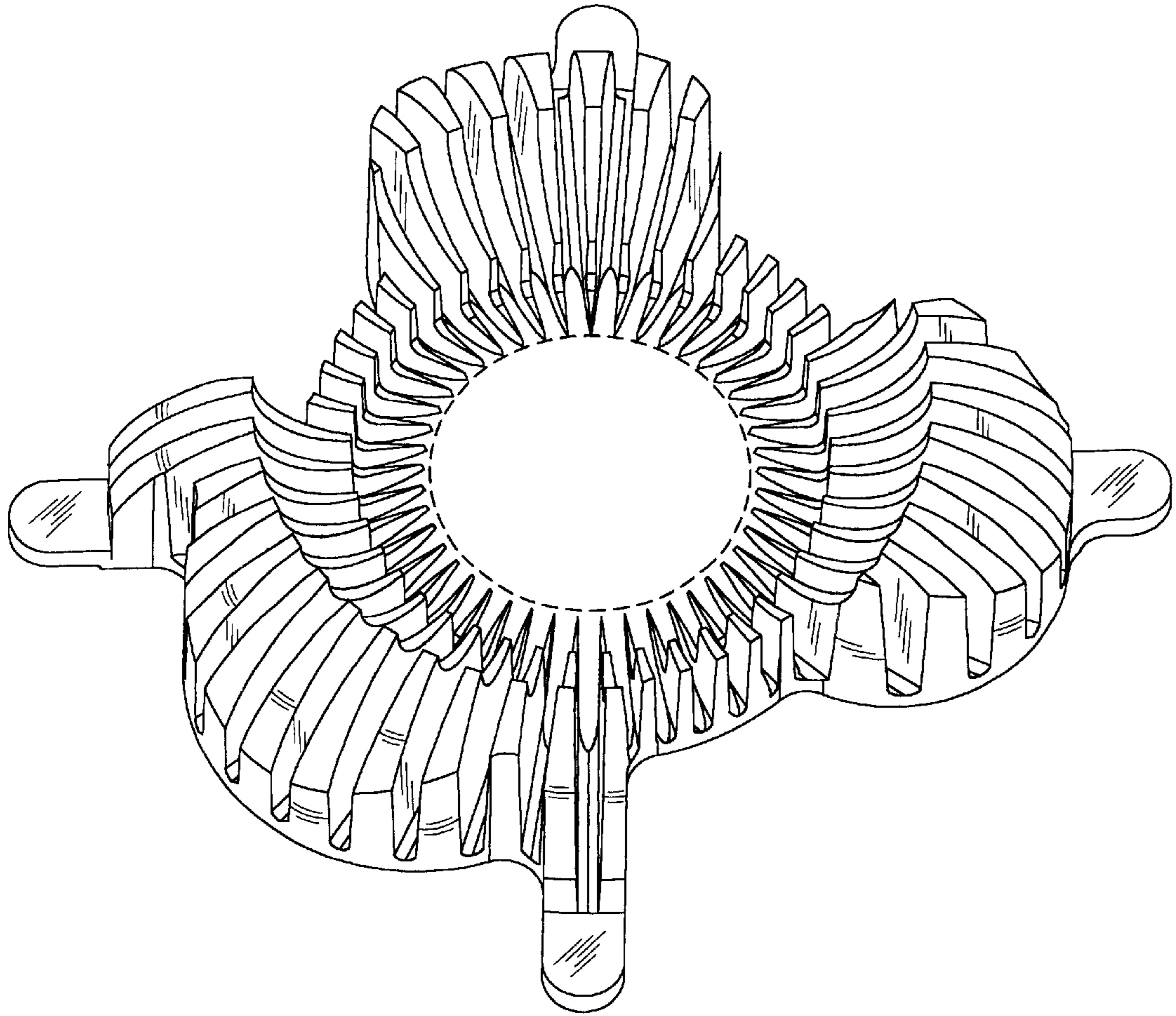

FIG. 15

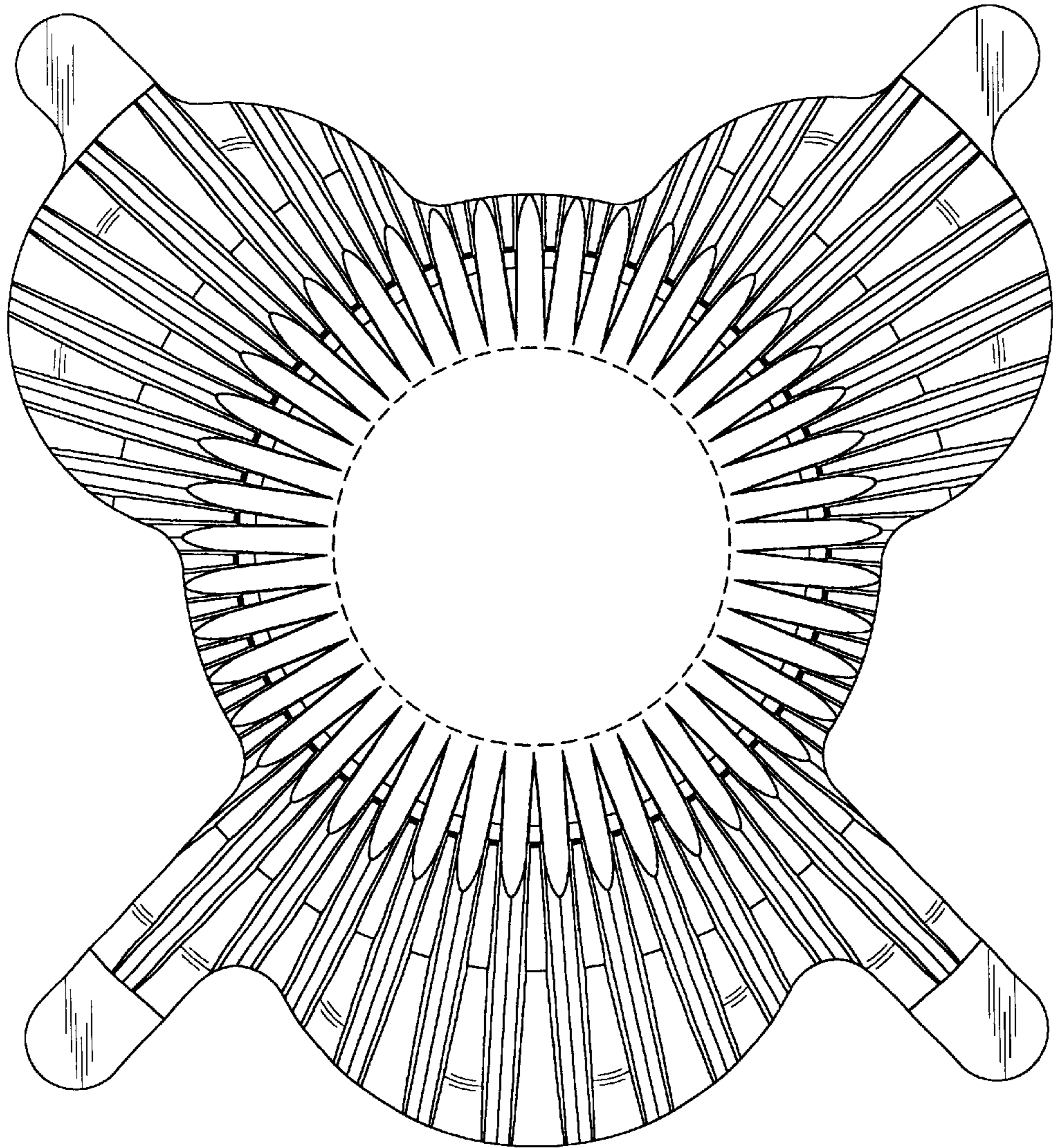

FIG. 16

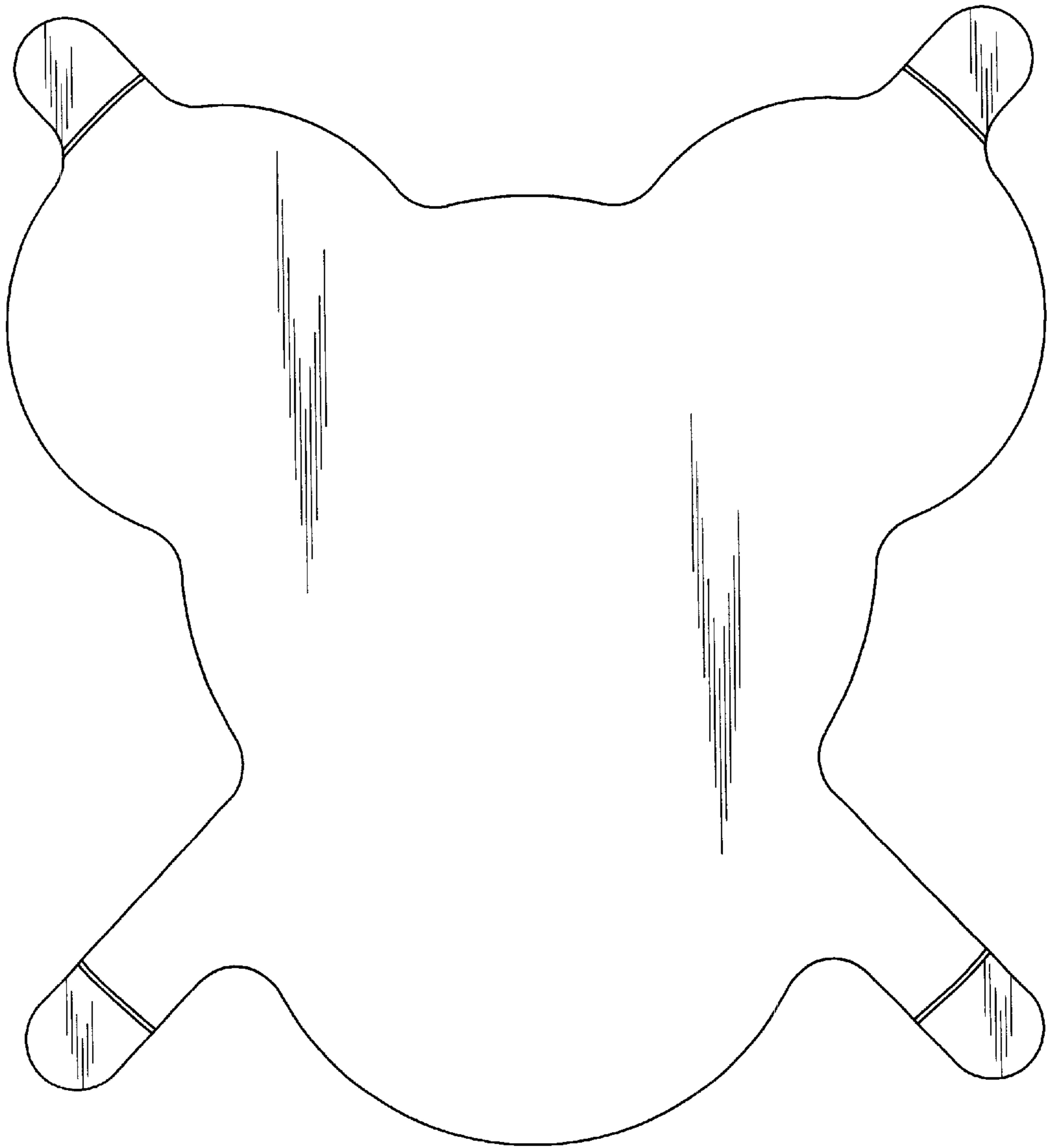

FIG. 17

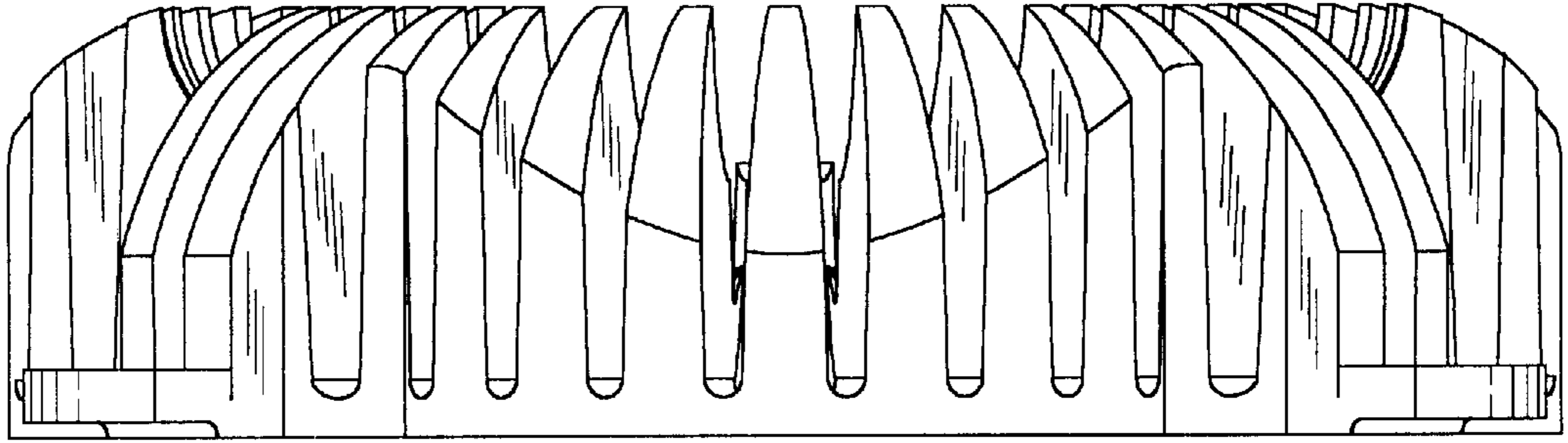

FIG. 18

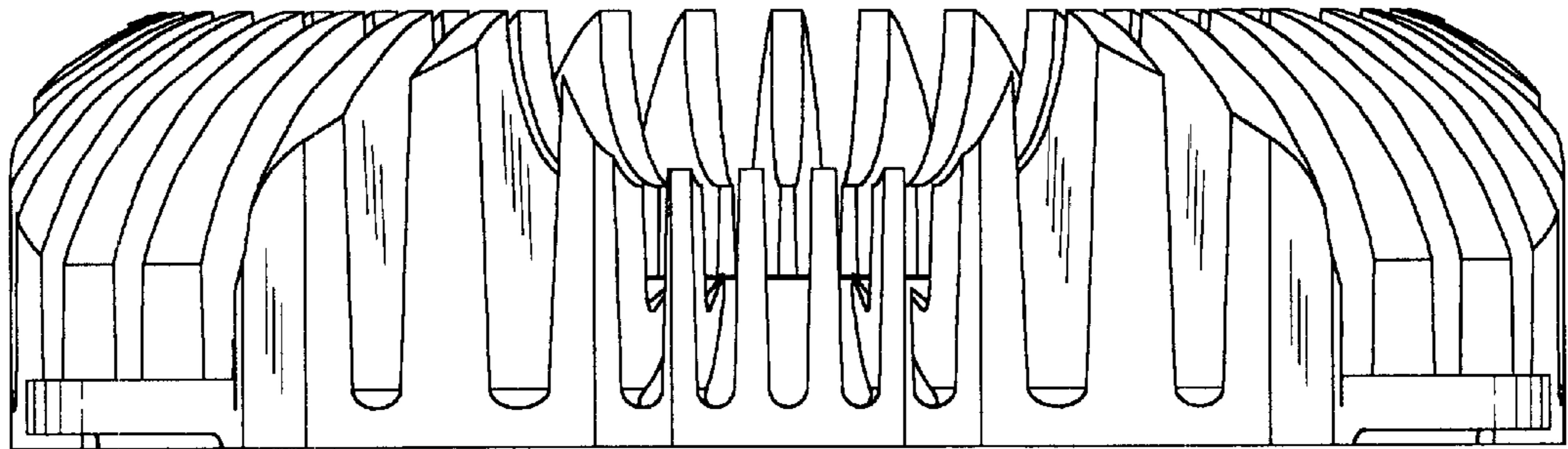

FIG. 19

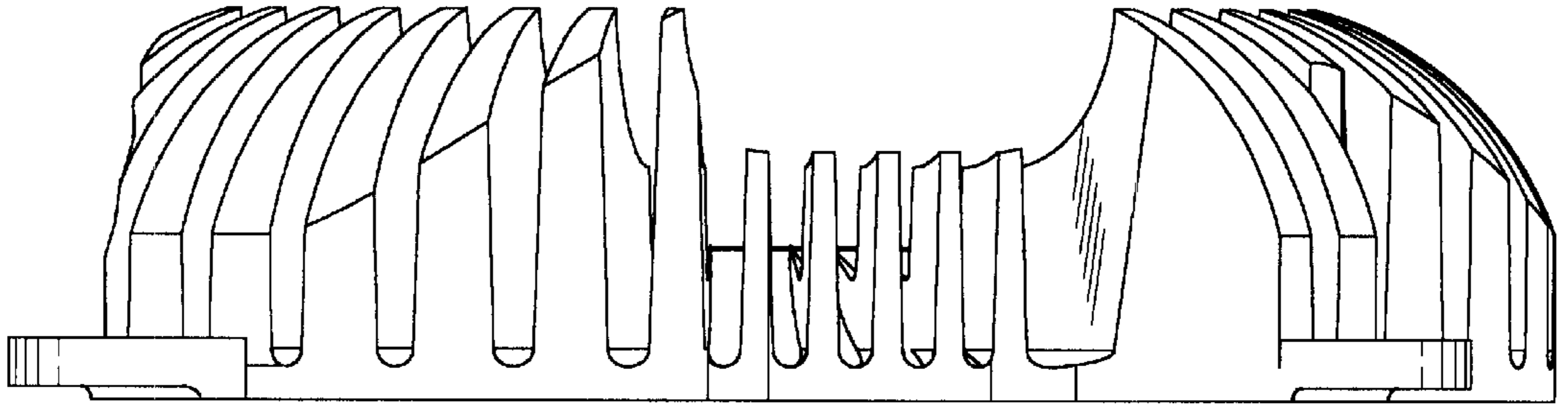

FIG. 20

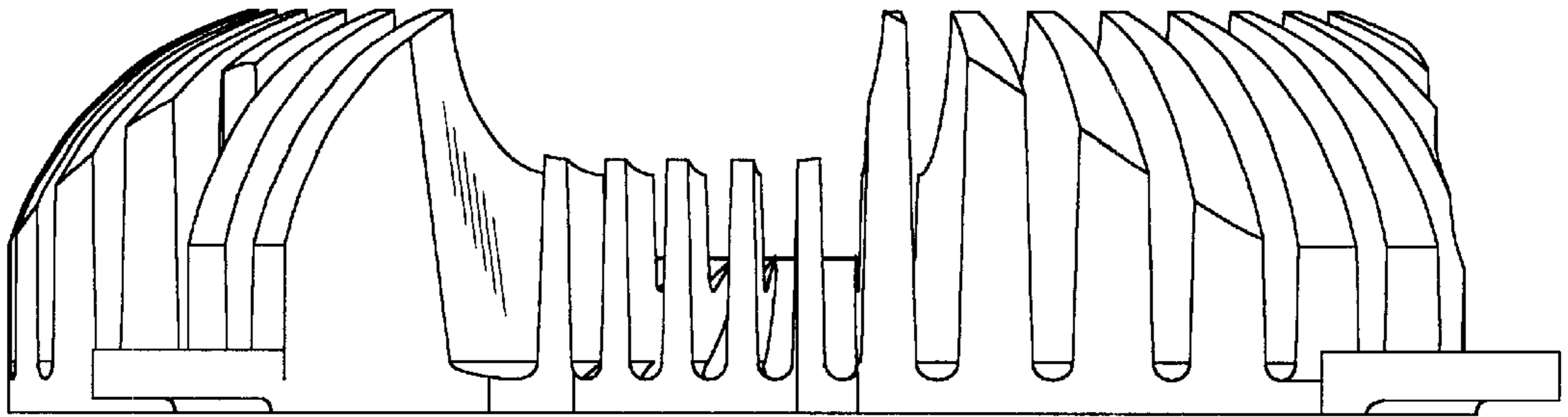

FIG. 21

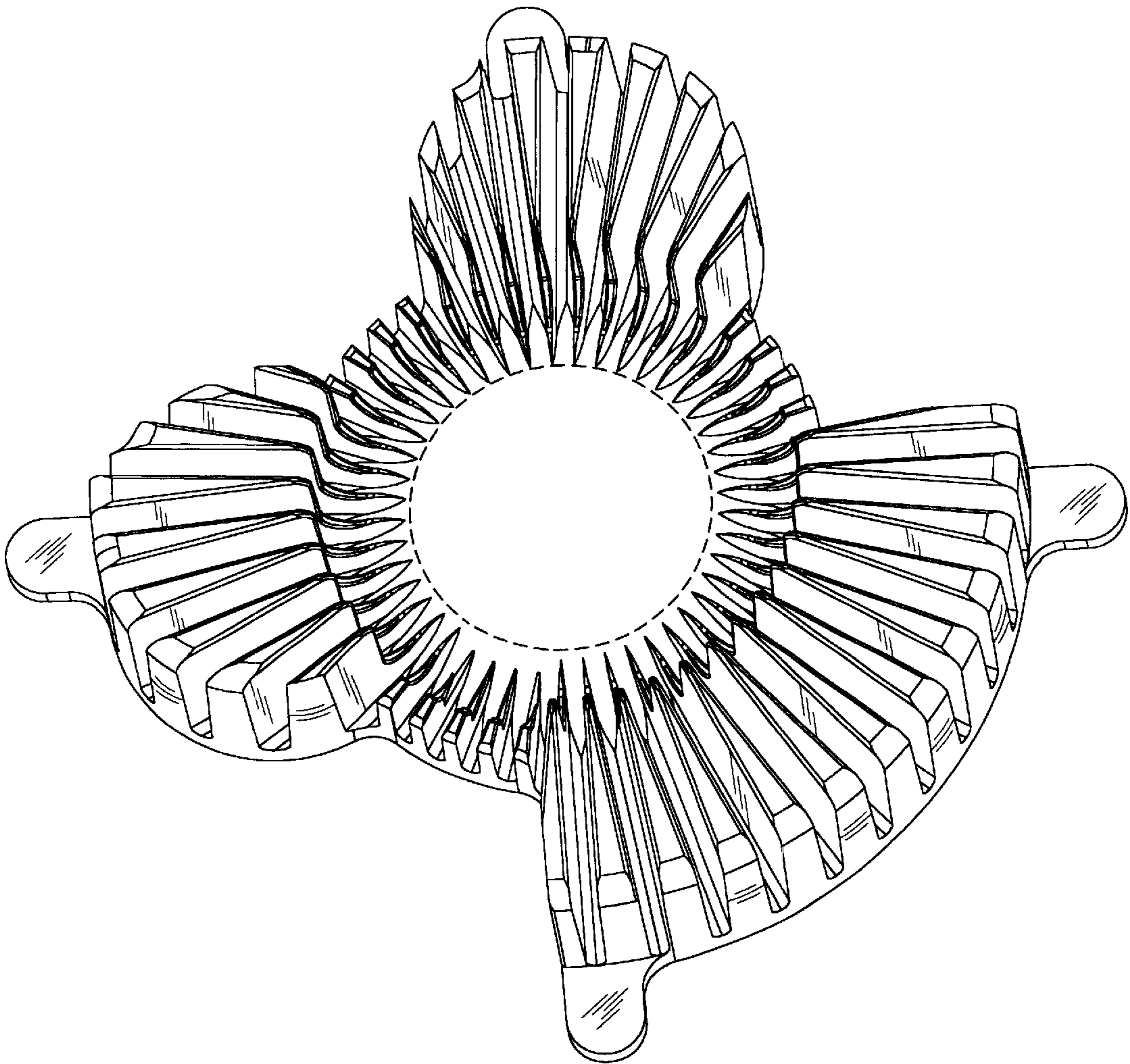

FIG. 22

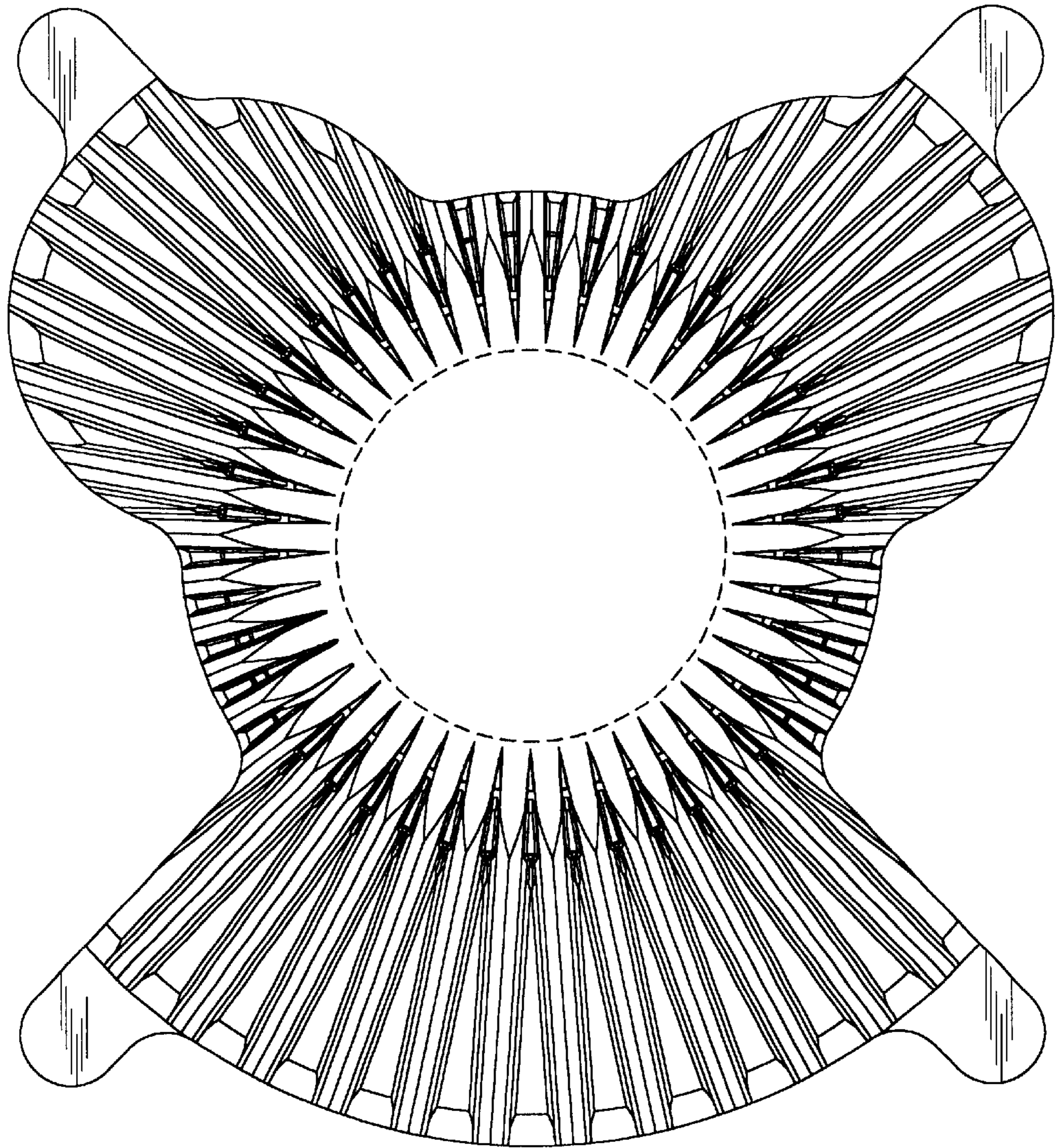

FIG. 23

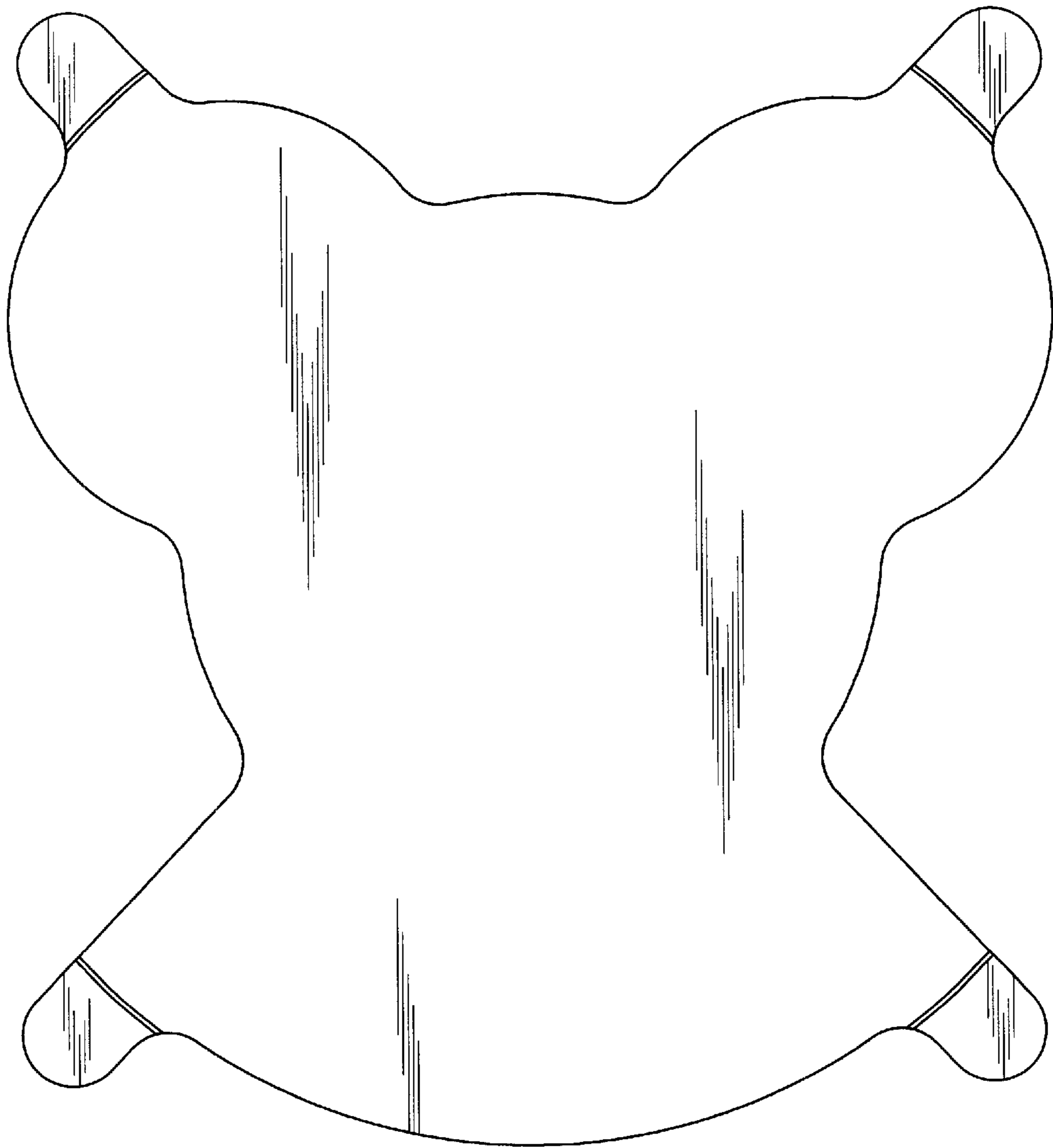

FIG. 24

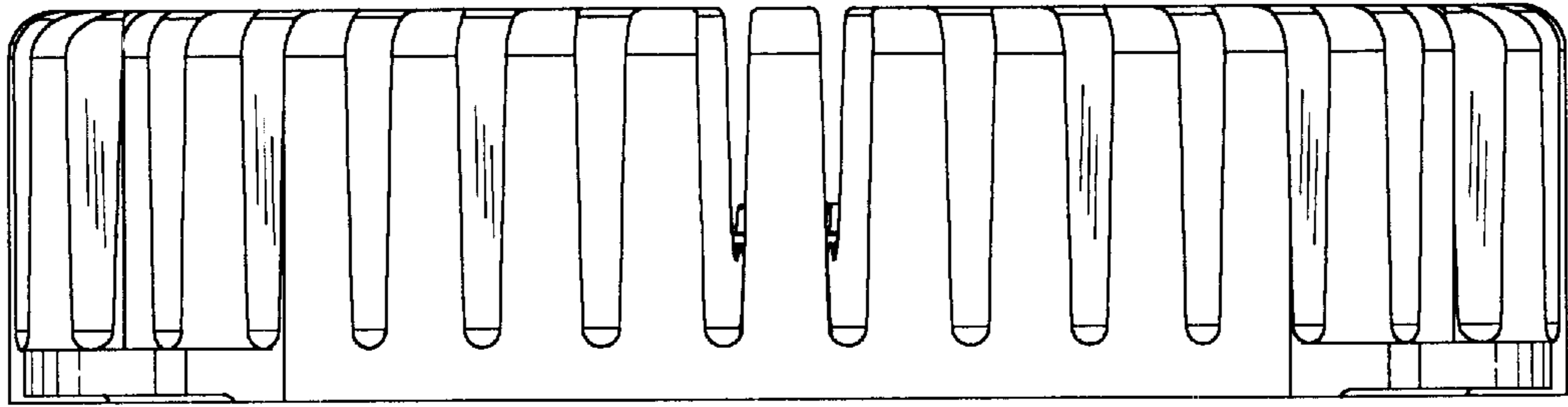

FIG. 25

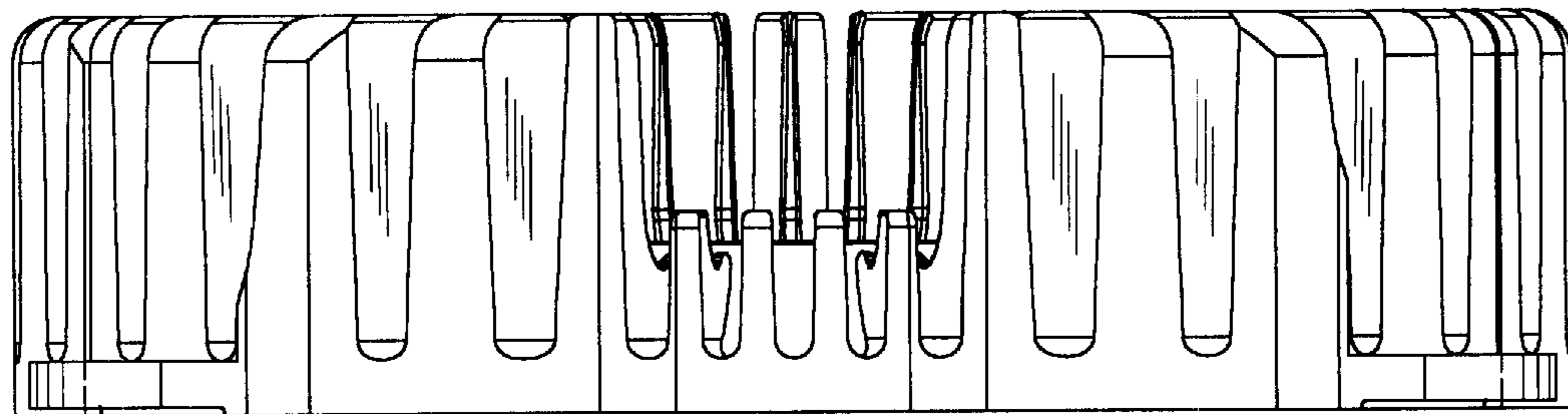

FIG. 26

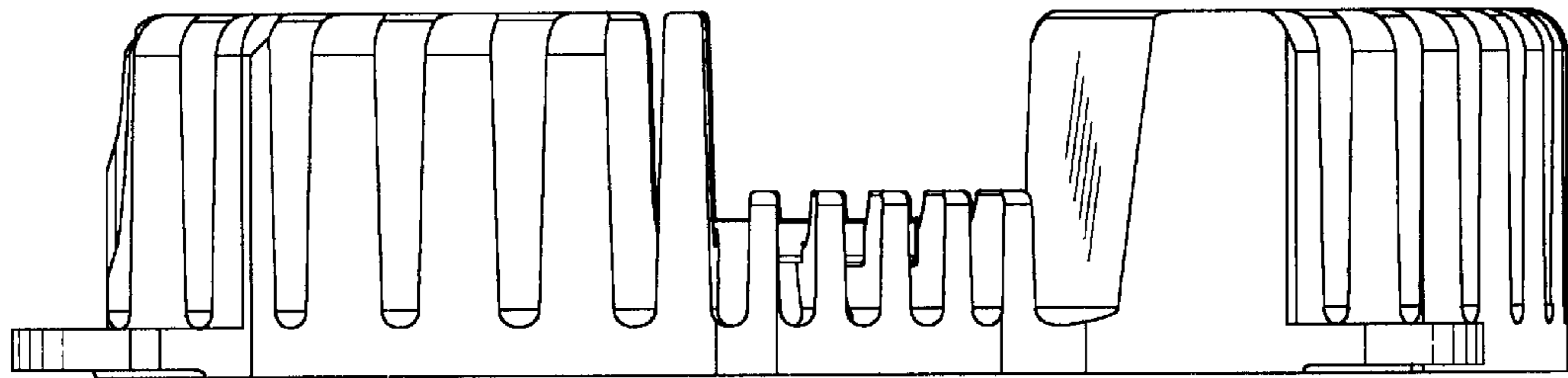

FIG. 27

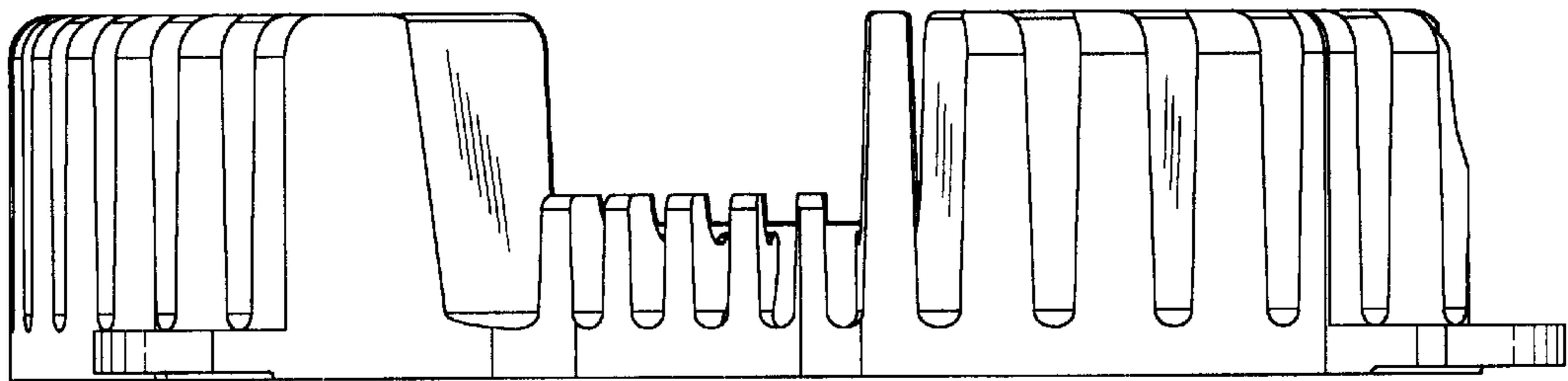

FIG. 28