



US00D455349S

(12) **United States Design Patent**
Lloyd

(10) **Patent No.:** **US D455,349 S**

(45) **Date of Patent:** **** Apr. 9, 2002**

- (54) **BOTTLE**
- (75) Inventor: **Douglas Lloyd**, New York, NY (US)
- (73) Assignee: **Intimate Beauty Corporation**, New York, NY (US)
- (**) Term: **14 Years**
- (21) Appl. No.: **29/145,577**
- (22) Filed: **Jul. 25, 2001**

- D342,676 S * 12/1993 Wuttke D9/529
- D345,918 S * 4/1994 Chevassus D9/529
- D349,058 S * 7/1994 Farce D9/523
- D380,355 S * 7/1997 Husted D9/529 X
- D398,530 S * 9/1998 Gavin D9/449
- D423,363 S * 4/2000 Loughnane D9/529
- D428,816 S * 8/2000 Shiokawa et al. D9/521
- D430,034 S * 8/2000 Kikuchi D9/529
- D438,790 S * 3/2001 Holthaus D9/338
- D439,165 S * 3/2001 Erckelbout et al. D9/521 X

* cited by examiner

Related U.S. Application Data

- (62) Division of application No. 29/131,133, filed on Oct. 13, 2000.
- (51) **LOC (7) Cl.** **09-01**
- (52) **U.S. Cl.** **D9/529**
- (58) **Field of Search** D9/500, 504, 516, D9/521, 529, 537, 539, 542, 549, 558, 574, 338, 300; 215/381-384, 396, 398, 400; 222/321.1-321.9, 142.1-142.9; D28/196

Primary Examiner—Ted Shooman
Assistant Examiner—Carol Rademaker
 (74) *Attorney, Agent, or Firm*—Colucci & Umans; Peter C. Michalos; Angelo Notaro

(57) **CLAIM**

The ornamental design for a bottle, as shown and described.

DESCRIPTION

FIG. 1 is a front elevational view of a bottle showing my new design therefore;
 FIG. 2 is a left side elevational view thereof;
 FIG. 3 is a right side elevational view thereof;
 FIG. 4 is a rear elevational view thereof;
 FIG. 5 is a top plan view thereof; and,
 FIG. 6 is a bottom plan view thereof.

(56) **References Cited**

U.S. PATENT DOCUMENTS

- D166,420 S * 4/1952 Schlutlig D28/77
- 3,342,379 A * 9/1967 Foley D9/521 X
- D230,954 S * 3/1974 Gregorietti D9/504
- D329,983 S * 10/1992 Griffin et al. D9/504

1 Claim, 5 Drawing Sheets

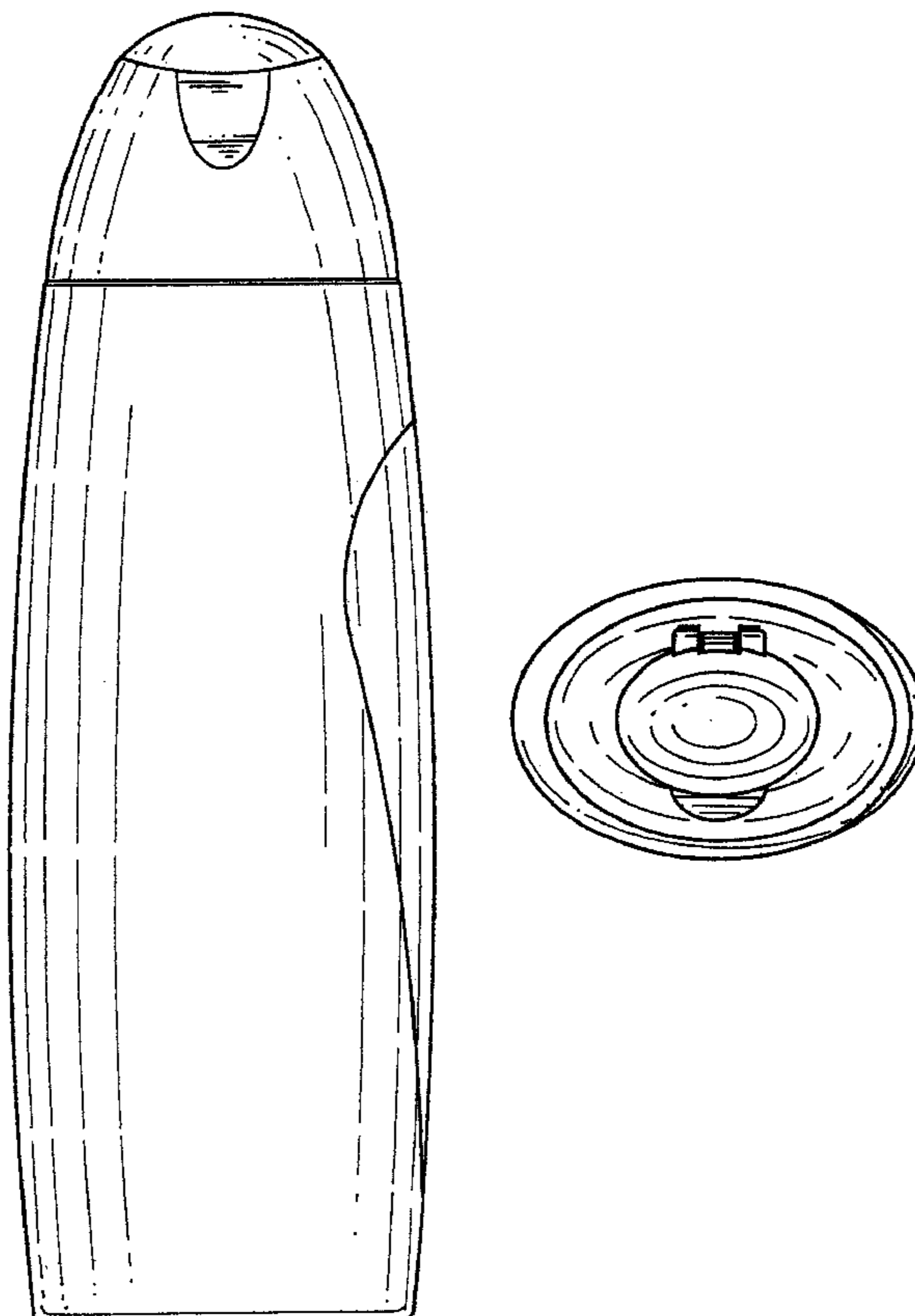

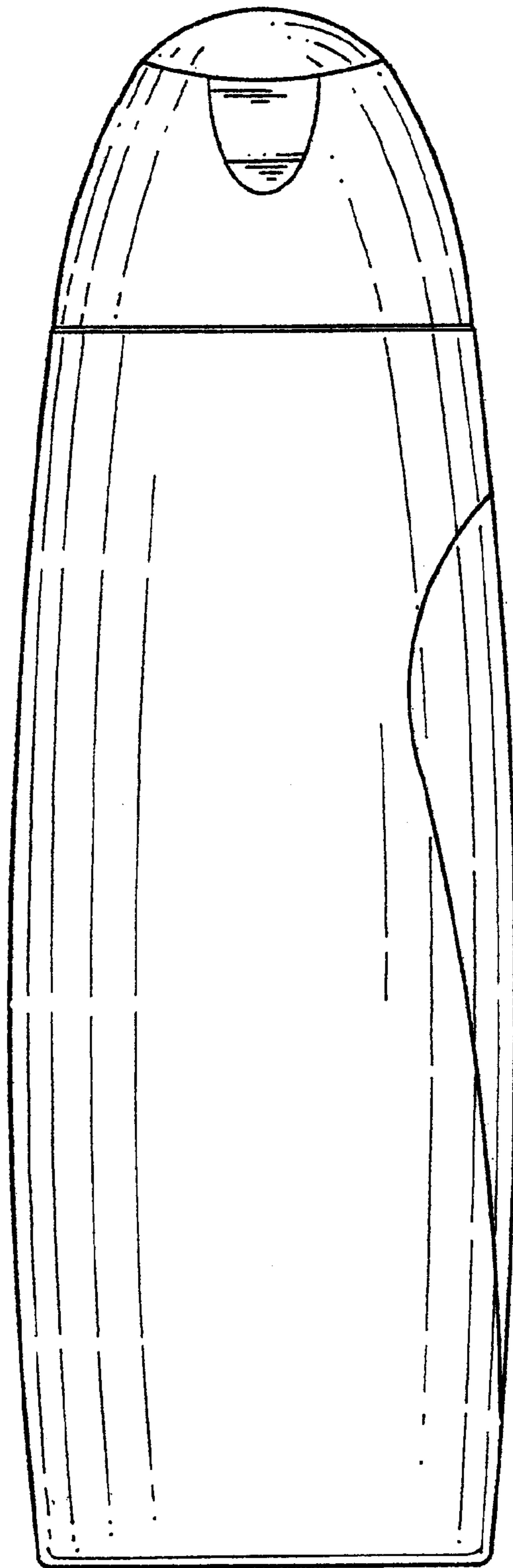

FIG. 1

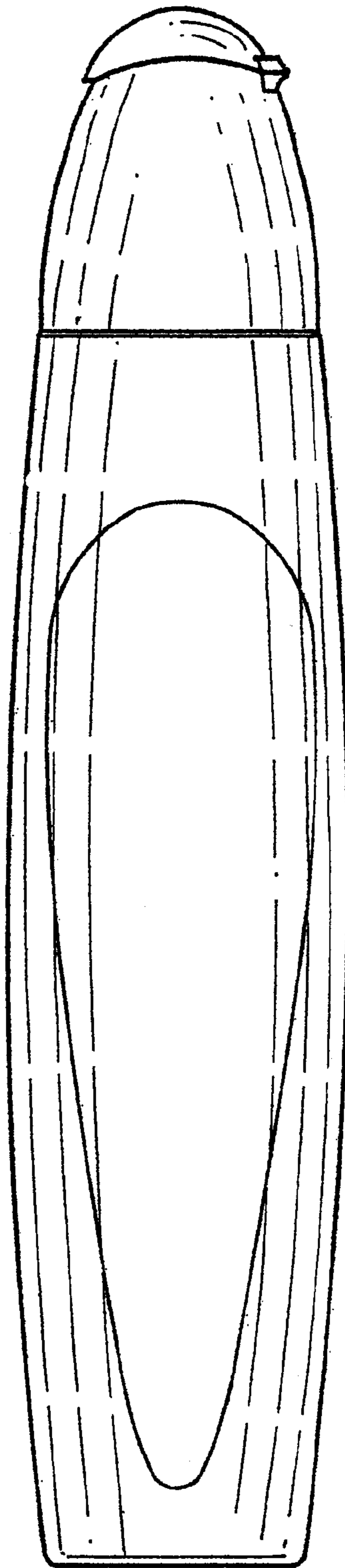

FIG. 2

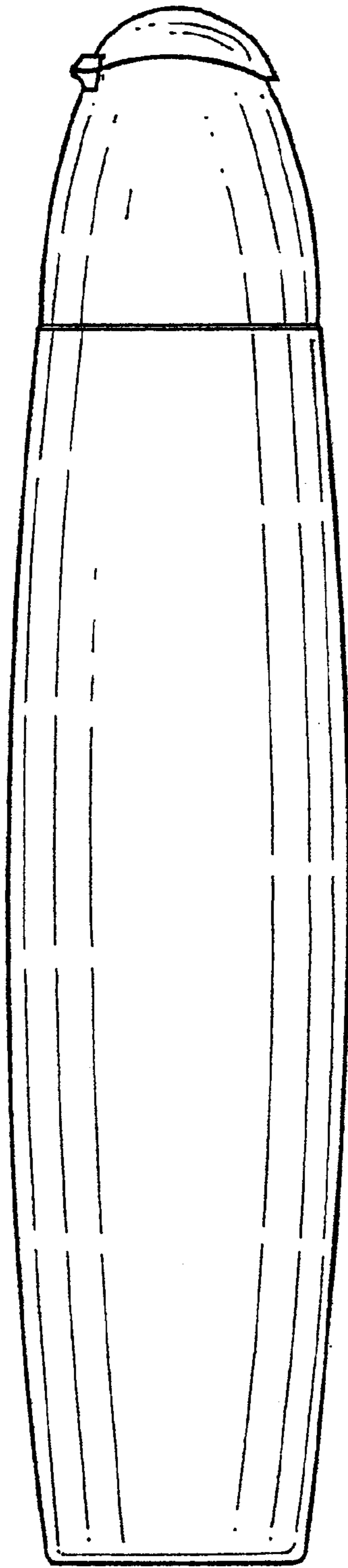

FIG. 3

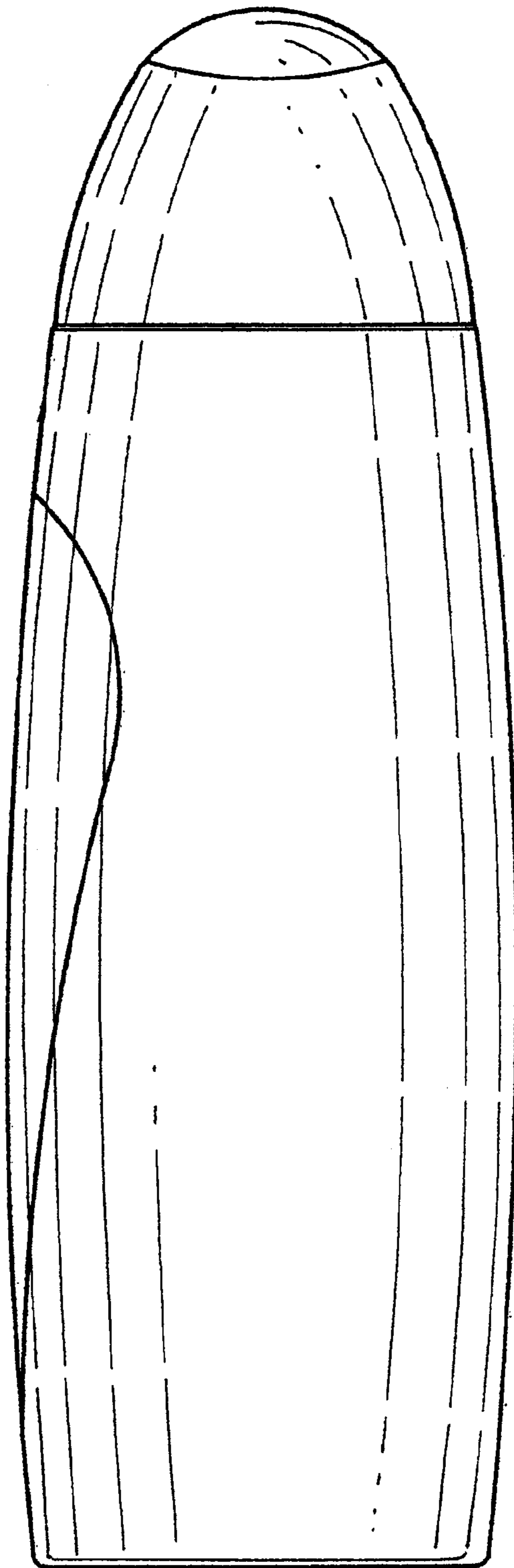

FIG. 4

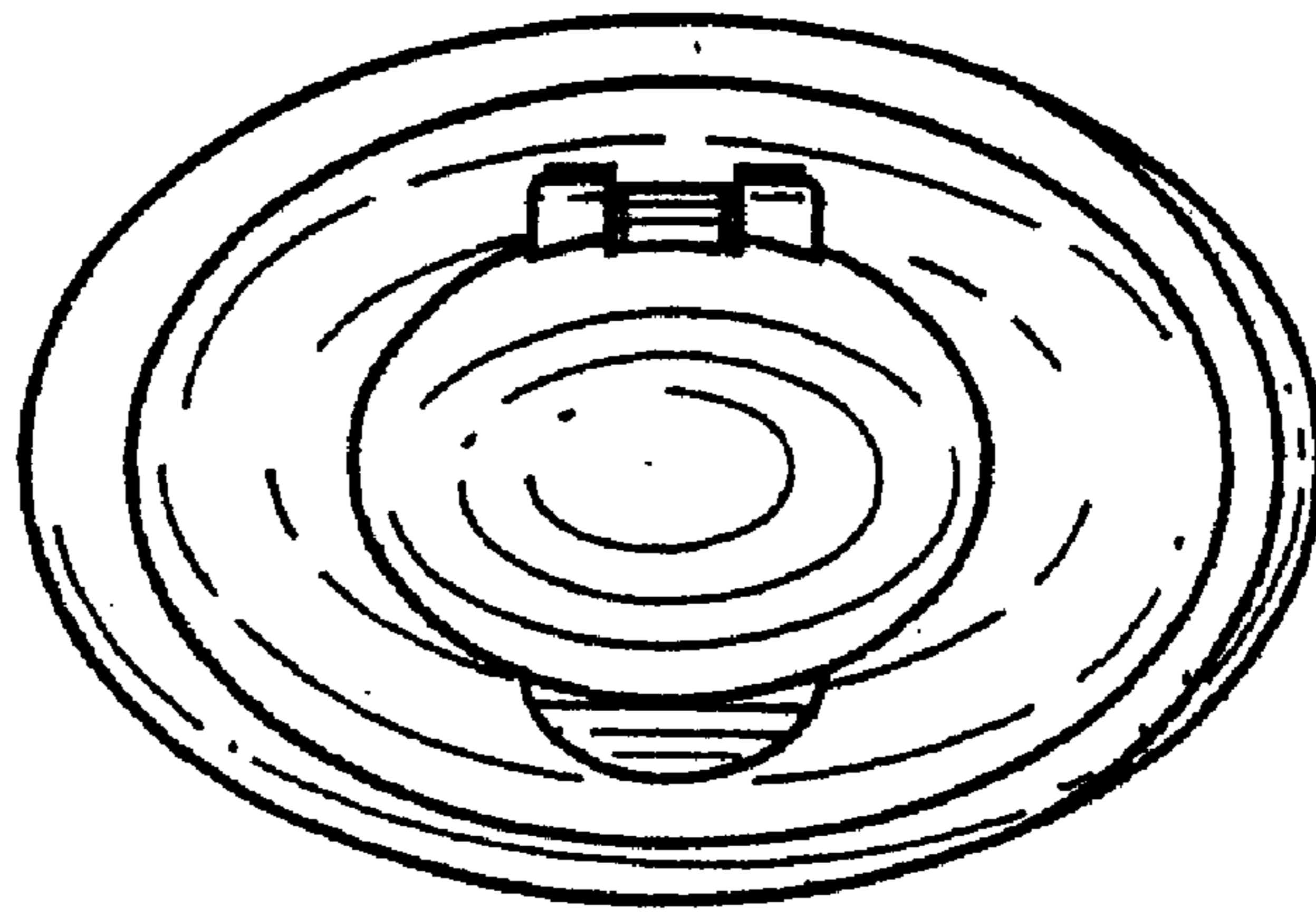

FIG. 5

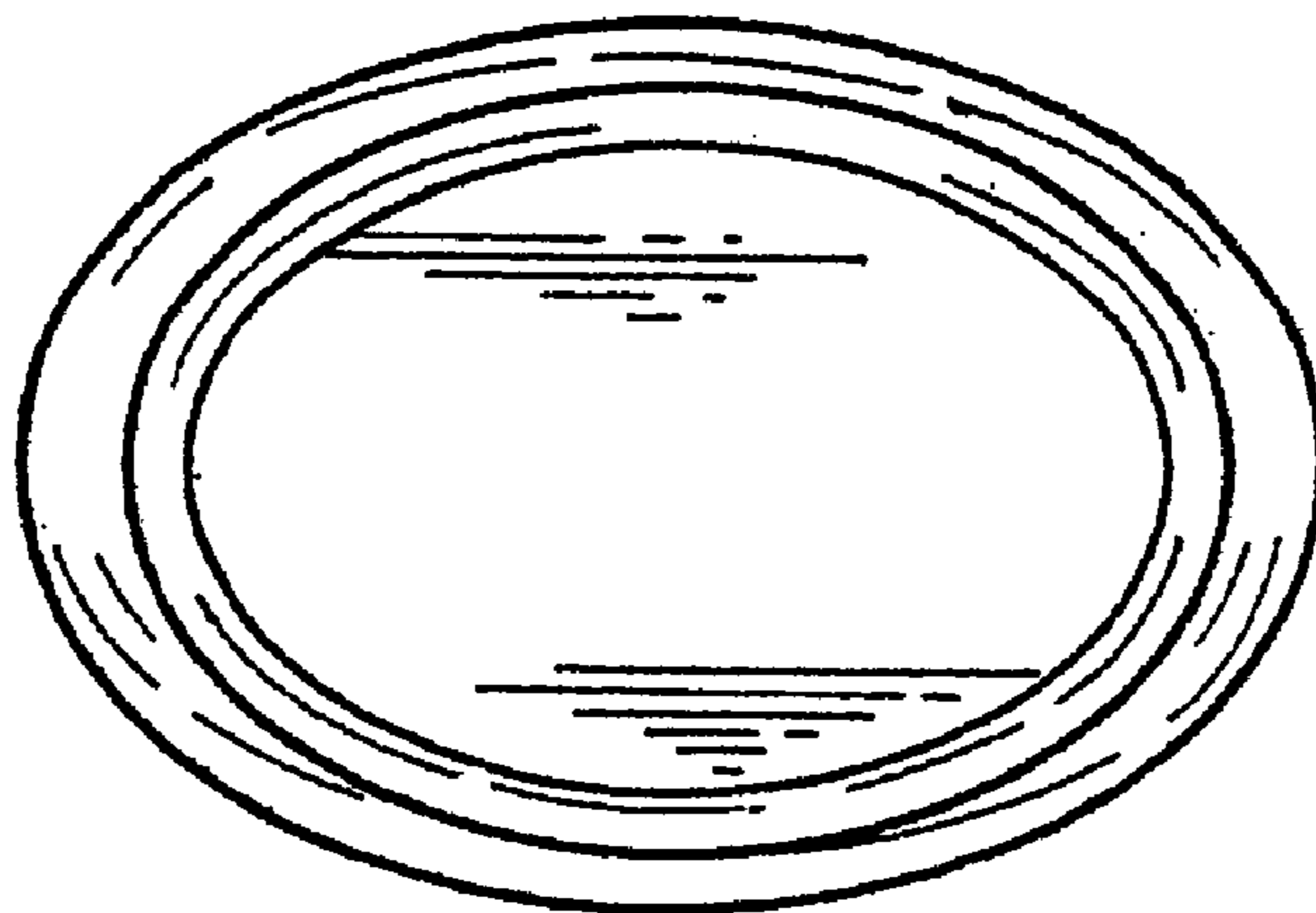

FIG. 6