



US00D455315S

(12) **United States Design Patent**
Cheng

(10) **Patent No.:** **US D455,315 S**

(45) **Date of Patent:** **** Apr. 9, 2002**

(54) **UPPER COOKWARE RIM WITH DUAL DIFFERENTLY-SIZED SPOUTS**
(76) Inventor: **Stanley Kin-Sui Cheng**, 382 Kwun Tong Road, Kwun Tong, Kowloon (HK)

(**) Term: **14 Years**

(21) Appl. No.: **29/122,916**

(22) Filed: **May 5, 2000**

(51) **LOC (7) Cl.** **07-02**

(52) **U.S. Cl.** **D7/354**

(58) **Field of Search** D7/323, 354-361, D7/667; 220/573.1; 222/572; 210/467

(56) **References Cited**

U.S. PATENT DOCUMENTS

D237,133 S	*	10/1975	Cyren	D7/361
4,310,418 A	*	1/1982	Busbey	210/467
D327,609 S	*	7/1992	Carlson	D7/667
5,388,732 A	*	2/1995	Greger	222/572

* cited by examiner

Primary Examiner—Caron D. Veynar
(74) *Attorney, Agent, or Firm*—Wood, Herron & Evans, L.L.P.

(57) **CLAIM**

The ornamental design for an upper cookware rim with dual differently-sized spouts, as shown and described.

DESCRIPTION

FIG. 1 is a top, right, and front perspective view of an upper cookware rim with dual differently-sized spouts showing my new design;

FIG. 2 is a front elevational view thereof;

FIG. 3 is a rear elevational view thereof;

FIG. 4 is a left side elevational view thereof;

FIG. 5 is a top plan view thereof; and,

FIG. 6 is a bottom plan view thereof.

The broken lines showing a handle in FIGS. 1-3, 5, and 6 are for illustrative purposes only and form no part of the claimed design.

1 Claim, 2 Drawing Sheets

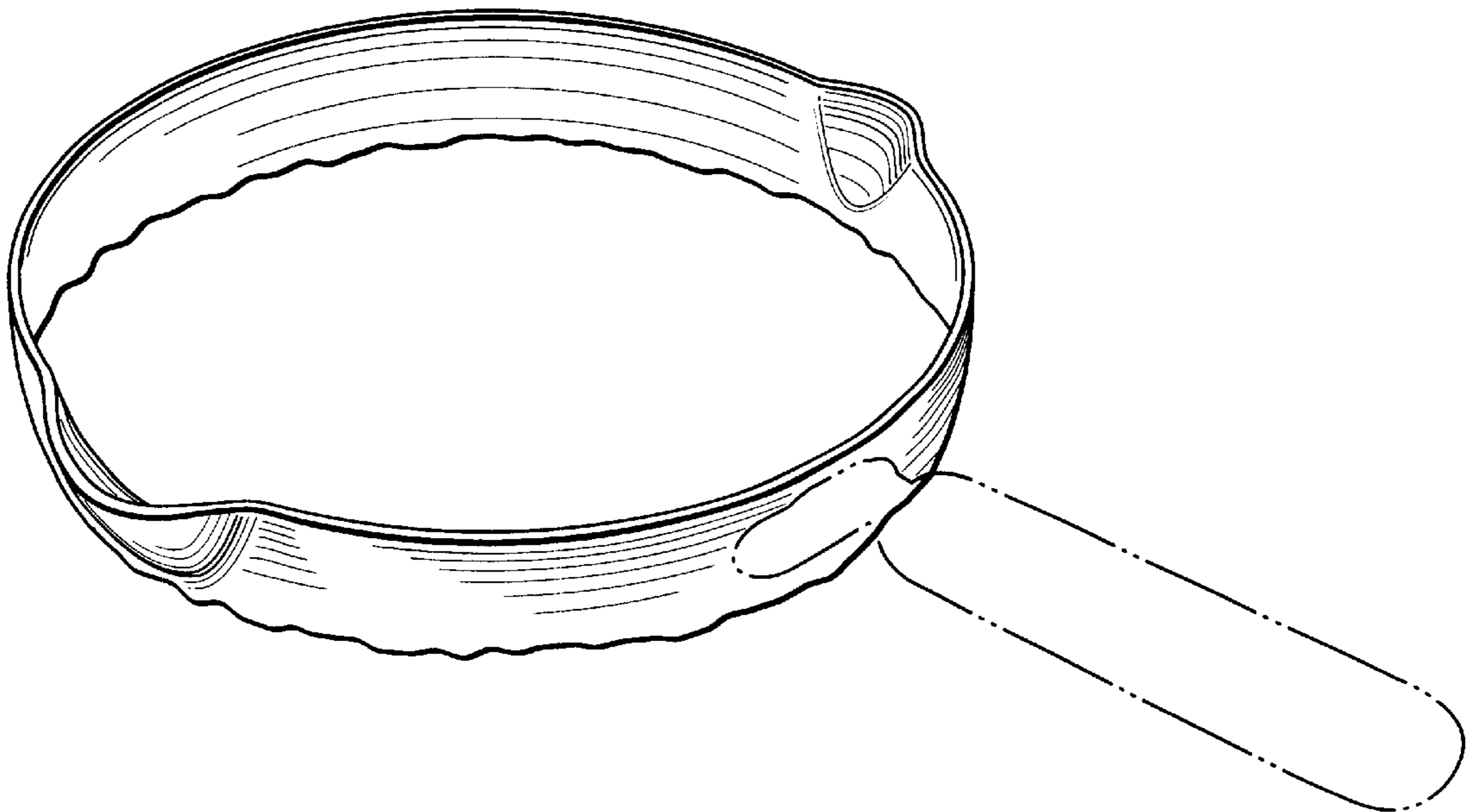

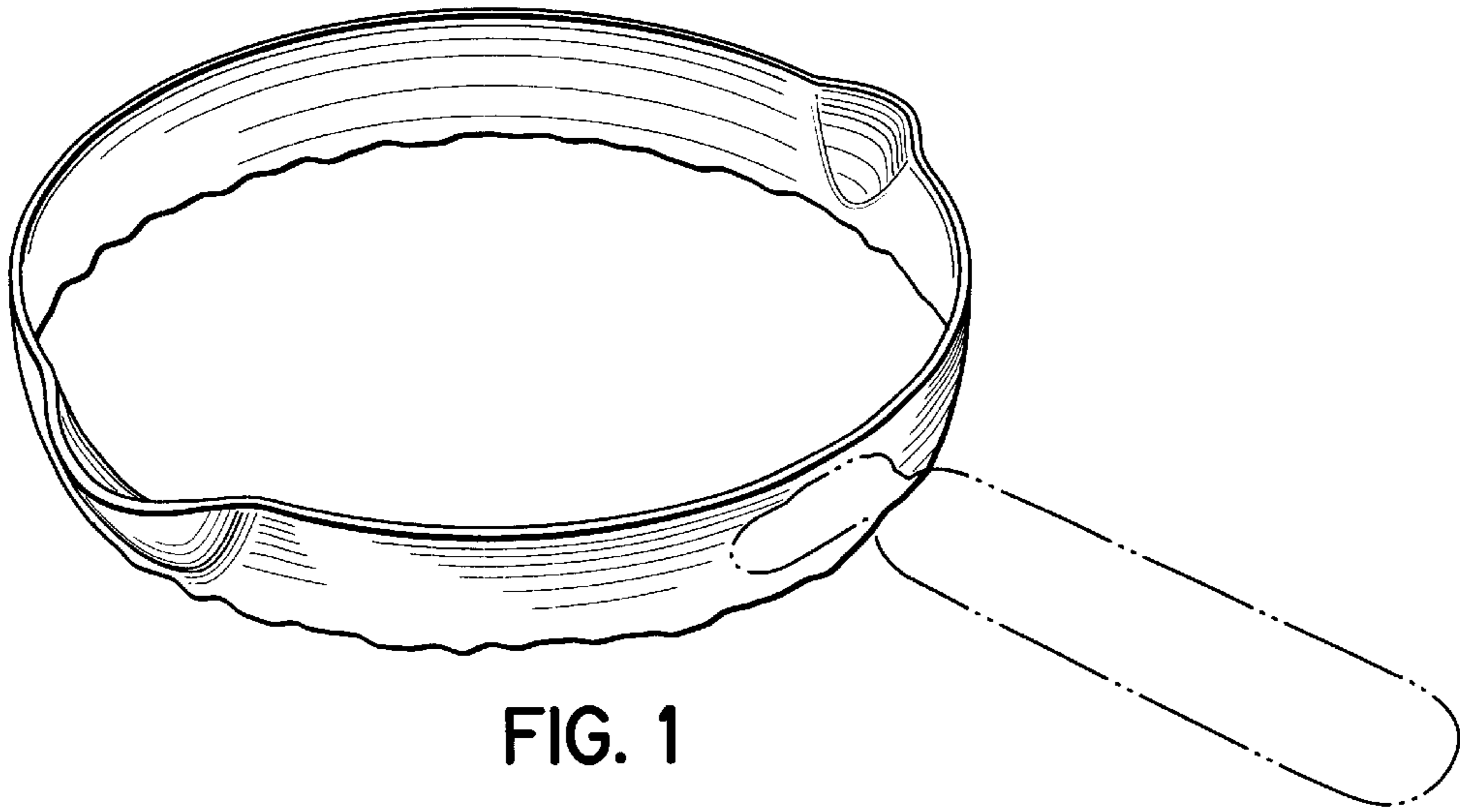

FIG. 1

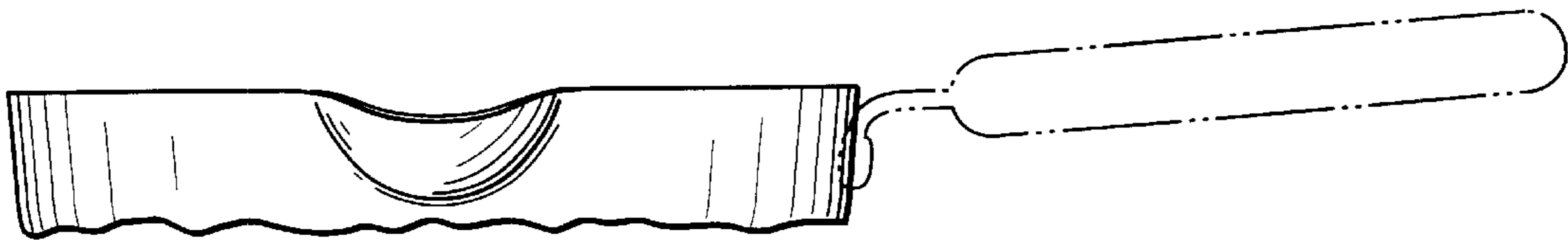

FIG. 2

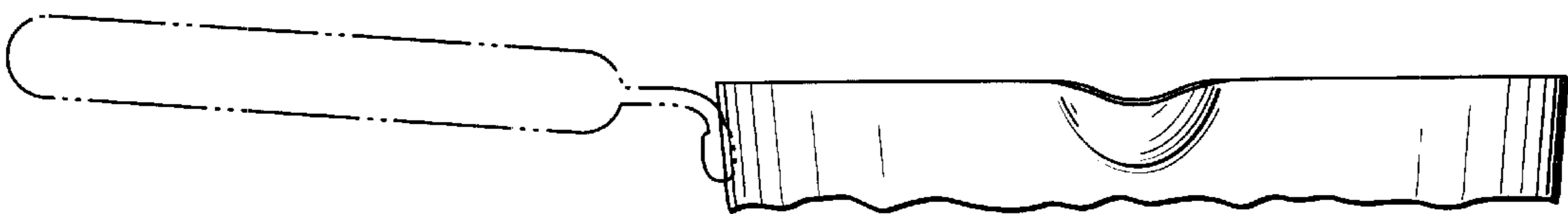

FIG. 3

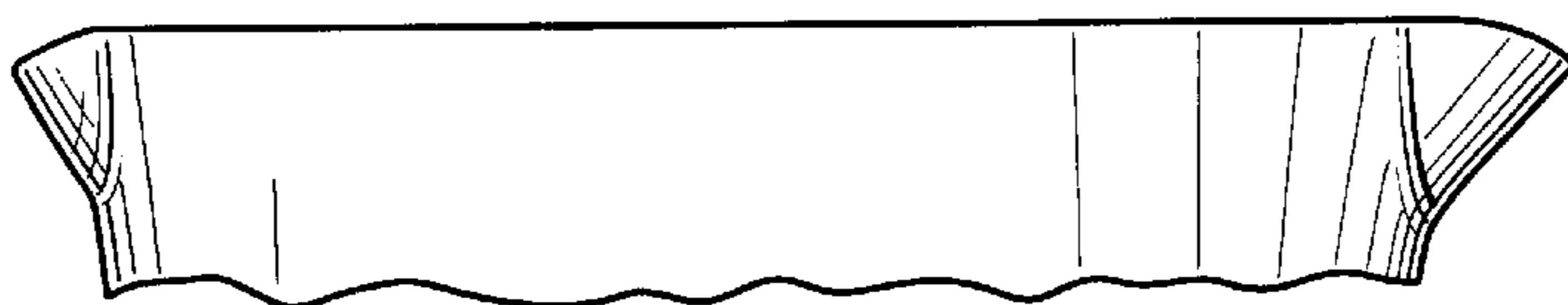

FIG. 4

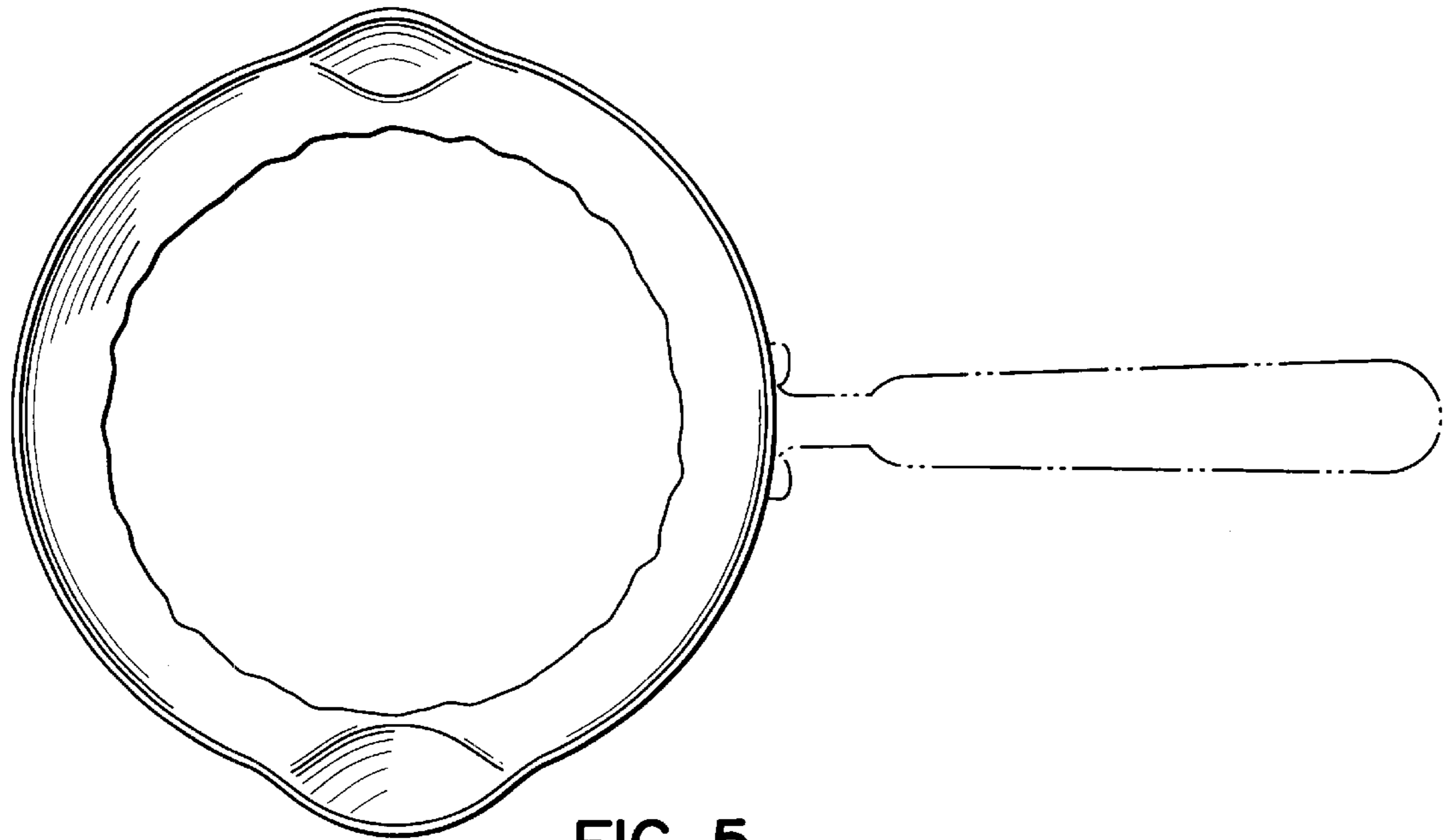

FIG. 5

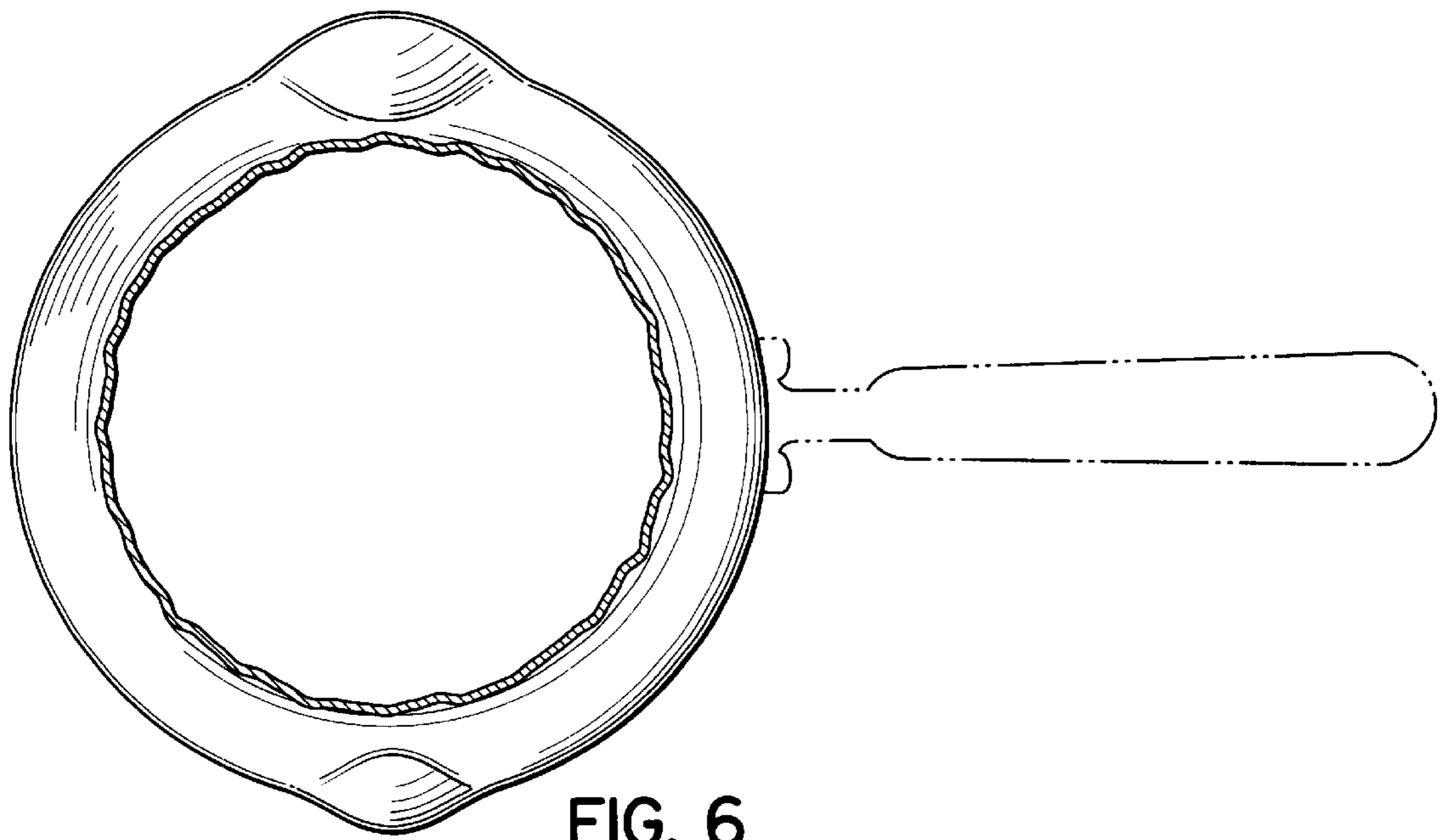

FIG. 6