



US00D455264S

(12) **United States Design Patent**
Lee

(10) **Patent No.:** **US D455,264 S**

(45) **Date of Patent:** **** Apr. 9, 2002**

(54) **STORAGE BOX FOR ELECTRONIC GAME CARTRIDGES**

(75) Inventor: **Man-Tat Lee, Kowloon (CN)**

(73) Assignee: **Storm Electronics Company Limited, Kowloon (CN)**

(**) Term: **14 Years**

(21) Appl. No.: **29/135,855**

(22) Filed: **Jan. 19, 2001**

(30) **Foreign Application Priority Data**

Aug. 29, 2000 (HK) 0011168

(51) **LOC (7) Cl.** **03-01**

(52) **U.S. Cl.** **D3/294; D3/273**

(58) **Field of Search** D3/273, 294, 295;
D9/420, 424, 425, 423; D6/635, 407; 206/701,
308.1

(56) **References Cited**

U.S. PATENT DOCUMENTS

4,625,885 A * 12/1986 Nichols 220/214

D329,331 S * 9/1992 Hobson D3/294

D353,744 S * 12/1994 Ferris et al. D9/420

D400,011 S * 10/1998 Palmer et al. D3/294

D411,446 S * 6/1999 Cautereels D9/424

D417,077 S * 11/1999 Sheu D3/420

D418,977 S * 1/2000 Striech D3/294

D437,521 S * 2/2001 Leung D6/635

D437,684 S * 2/2001 Streich et al. D3/273

* cited by examiner

Primary Examiner—Philip S. Hyder

(74) *Attorney, Agent, or Firm*—Alix, Yale & Ristas, LLP

(57) **CLAIM**

The ornamental design for a storage box for electronic game cartridges, as shown and described.

DESCRIPTION

FIG. 1 is a perspective view of a storage box for electronic game cartridges showing my new design;

FIG. 2 is a front perspective view in opened position thereof;

FIG. 3 is a front elevational view thereof;

FIG. 4 is a rear elevational view thereof;

FIG. 5 is a left side elevational view thereof;

FIG. 6 is a right side elevational view thereof;

FIG. 7 is a top plan view thereof; and,

FIG. 8 is a bottom plan view thereof.

1 Claim, 6 Drawing Sheets

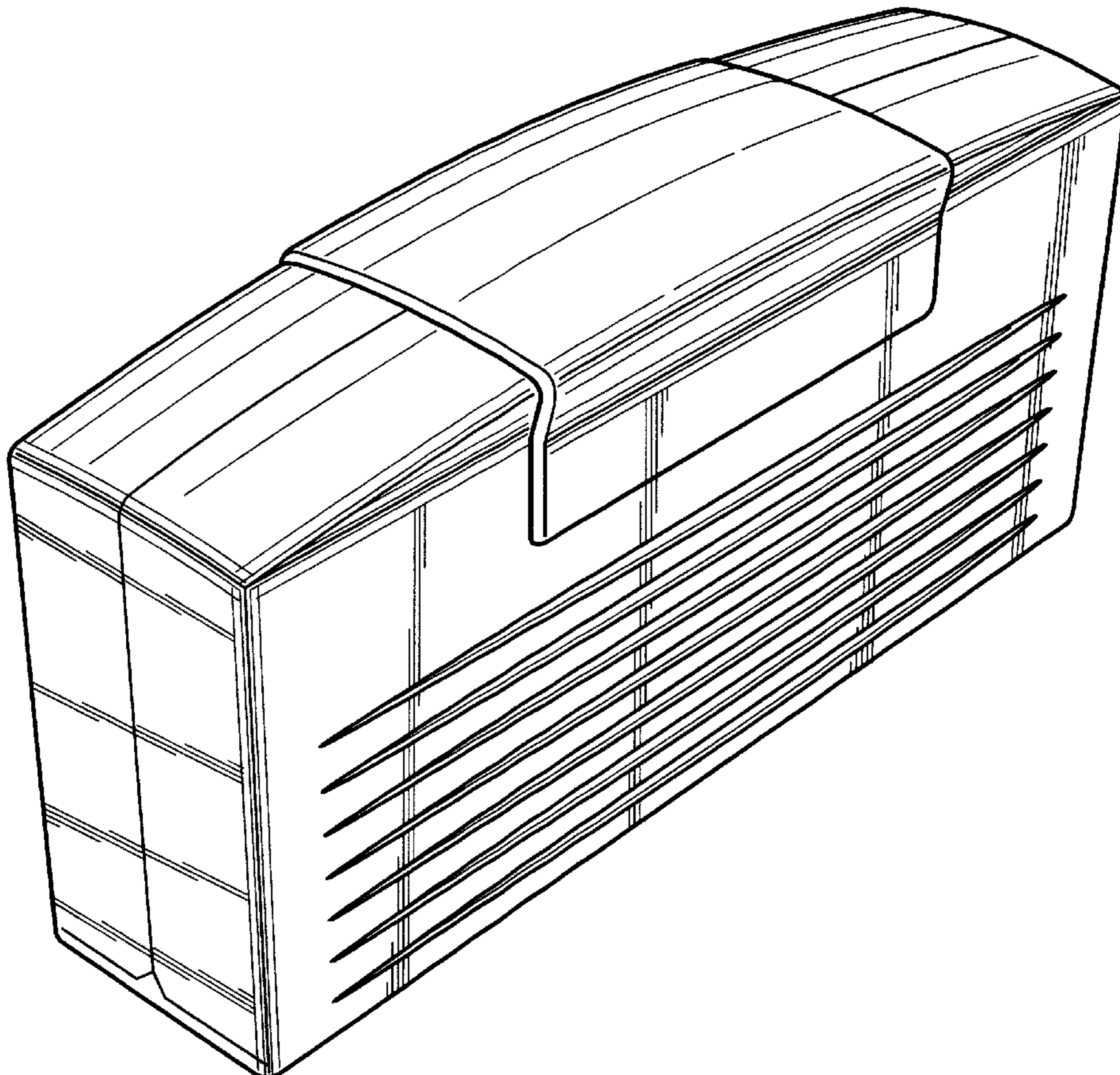

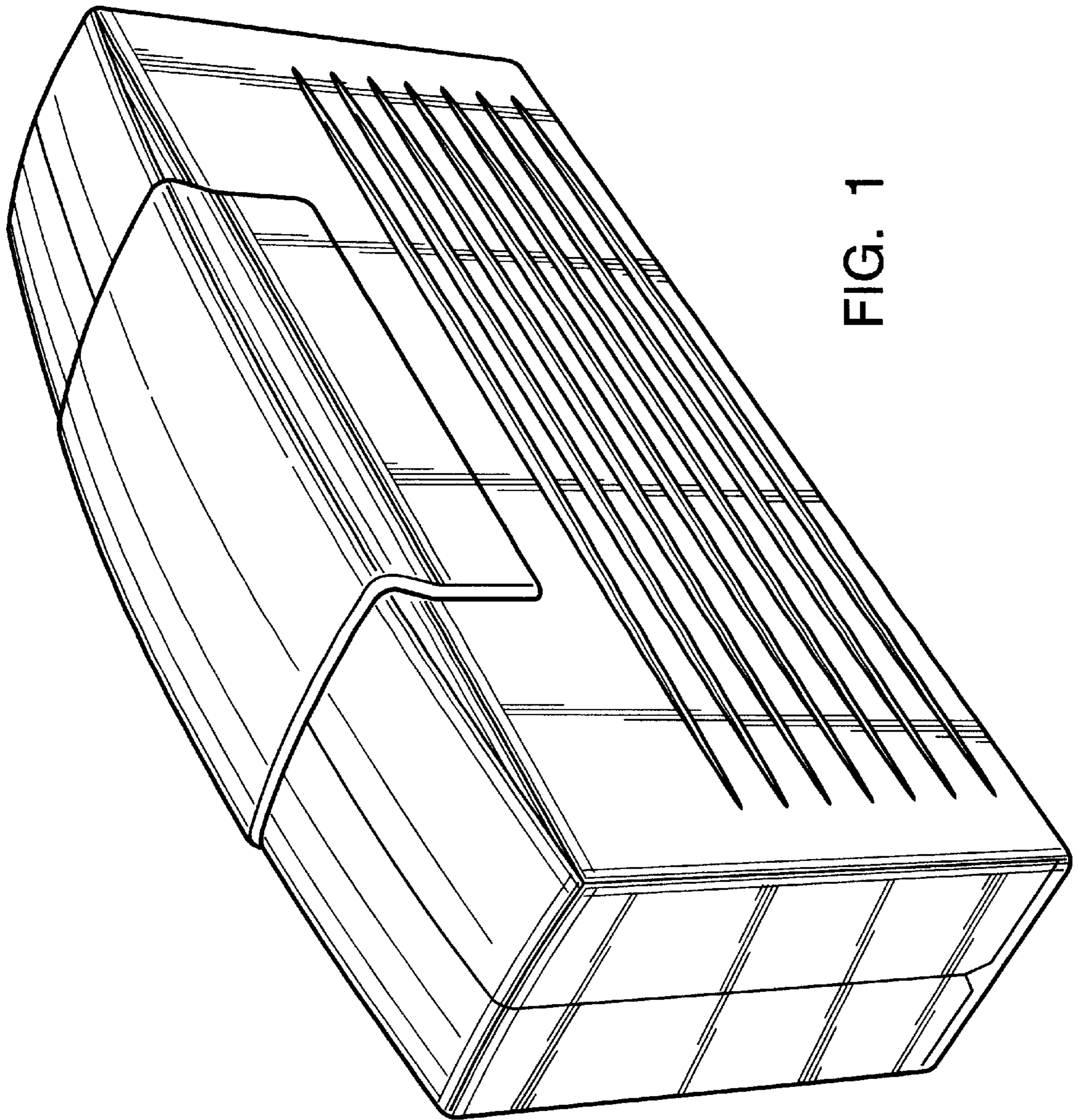
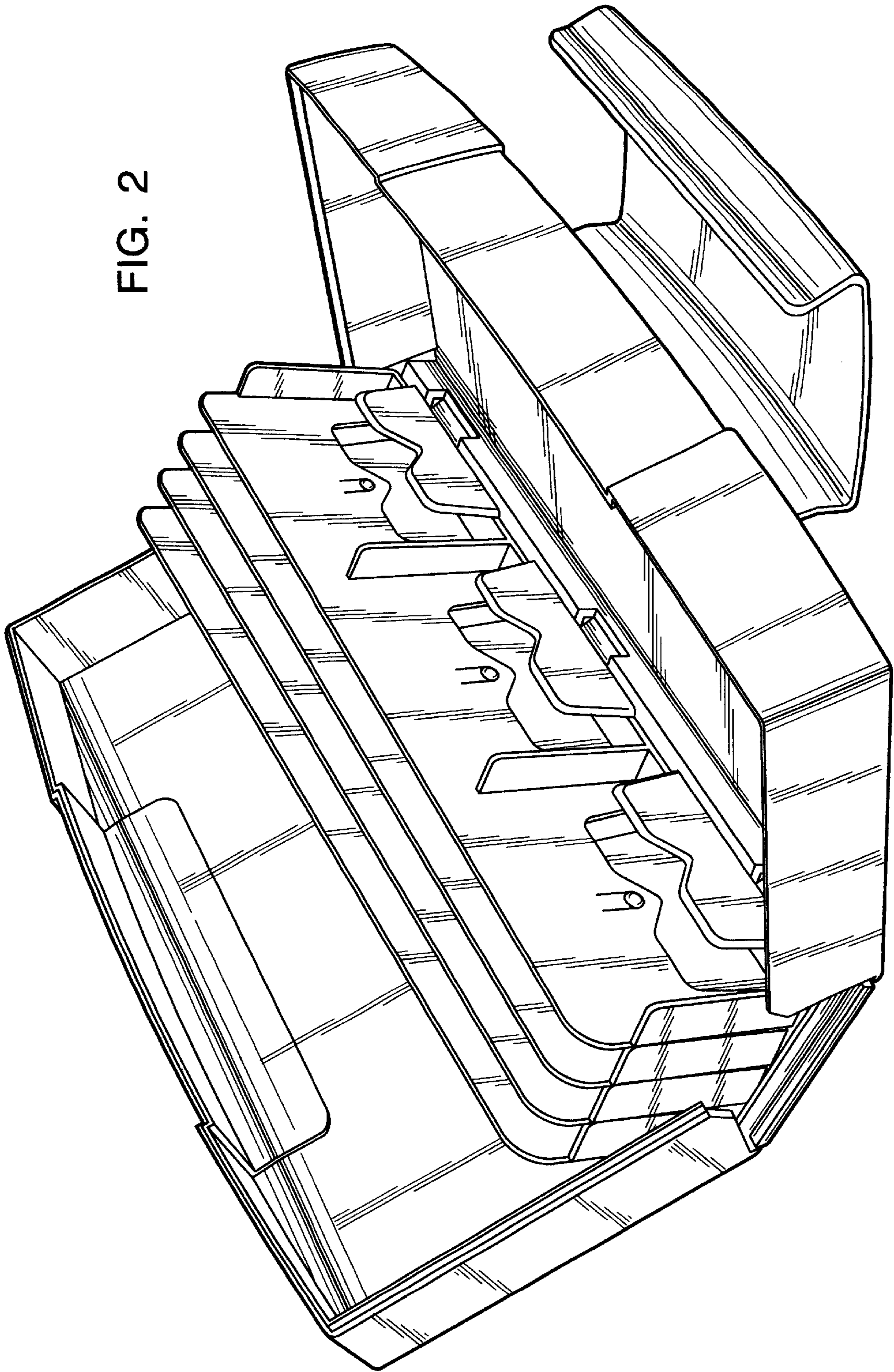

FIG. 1

FIG. 2



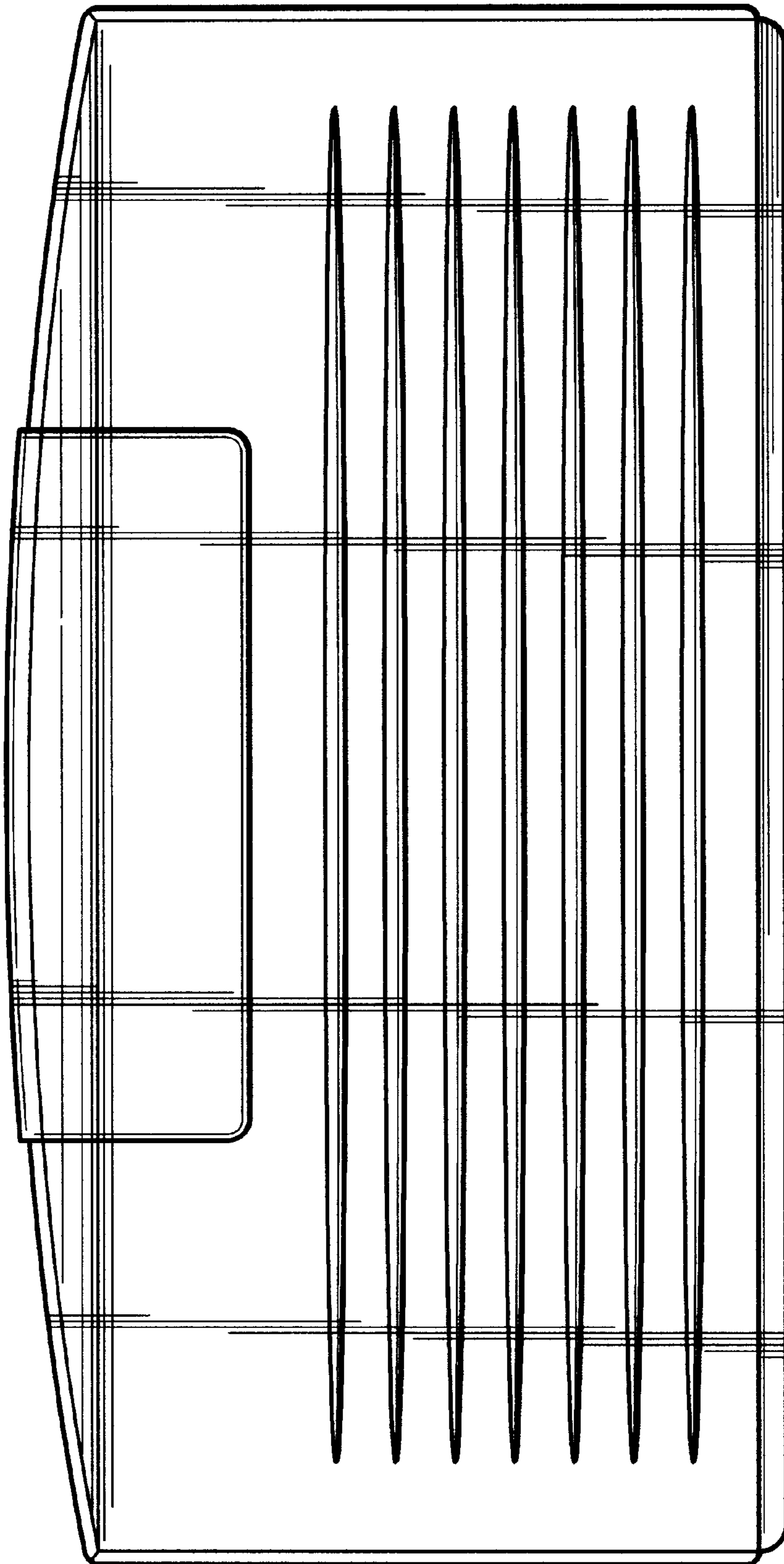

FIG. 3

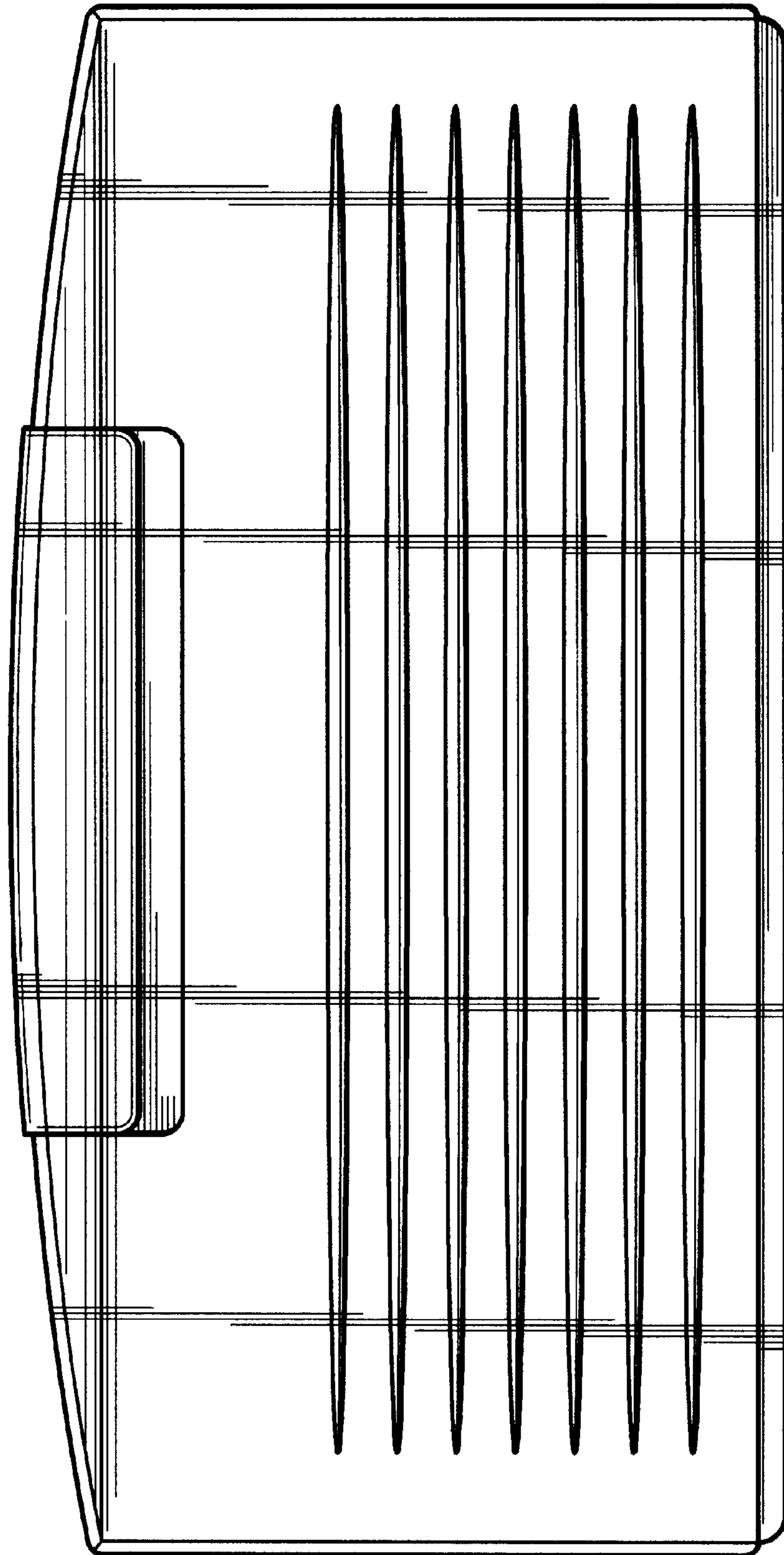

FIG. 4

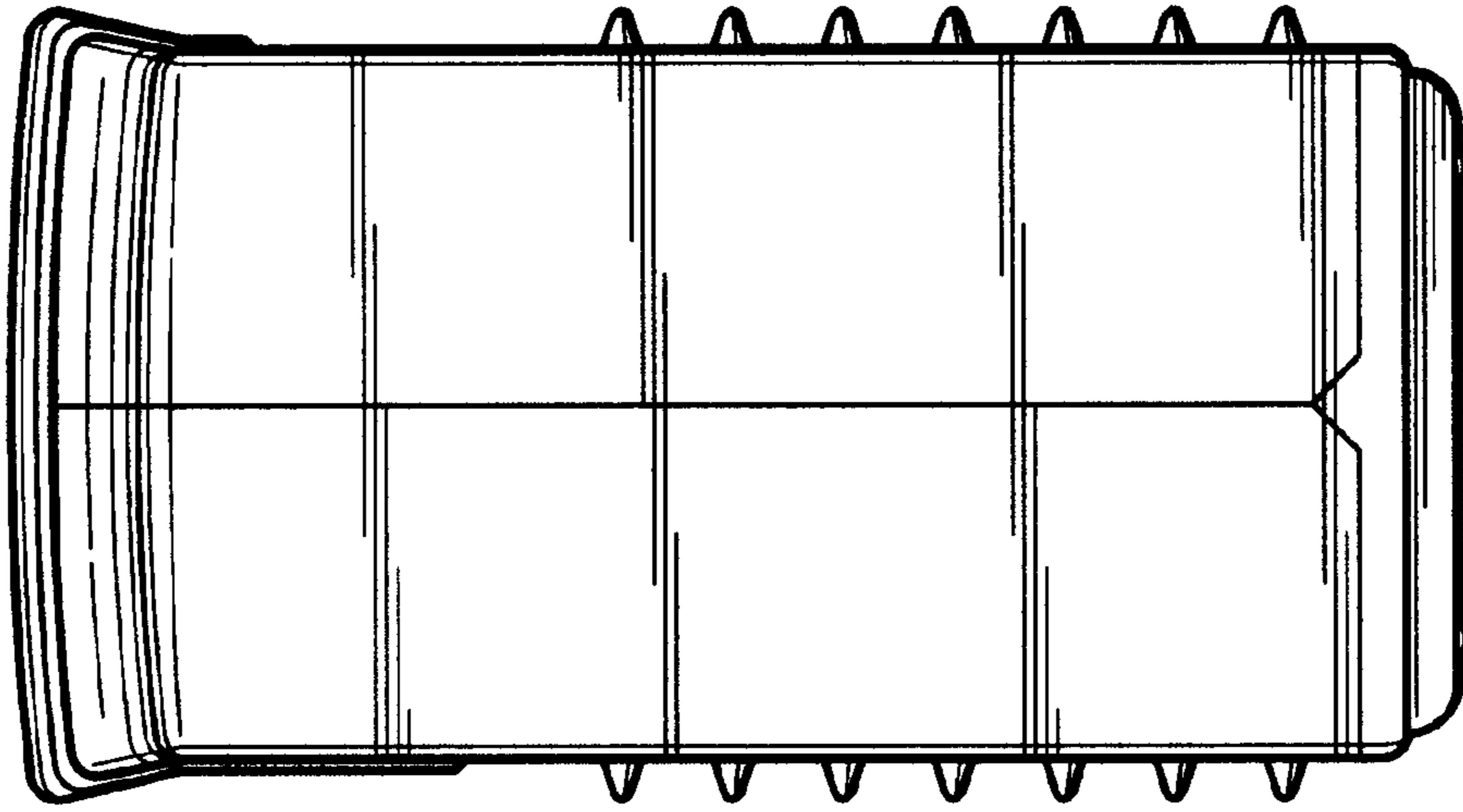

FIG. 5

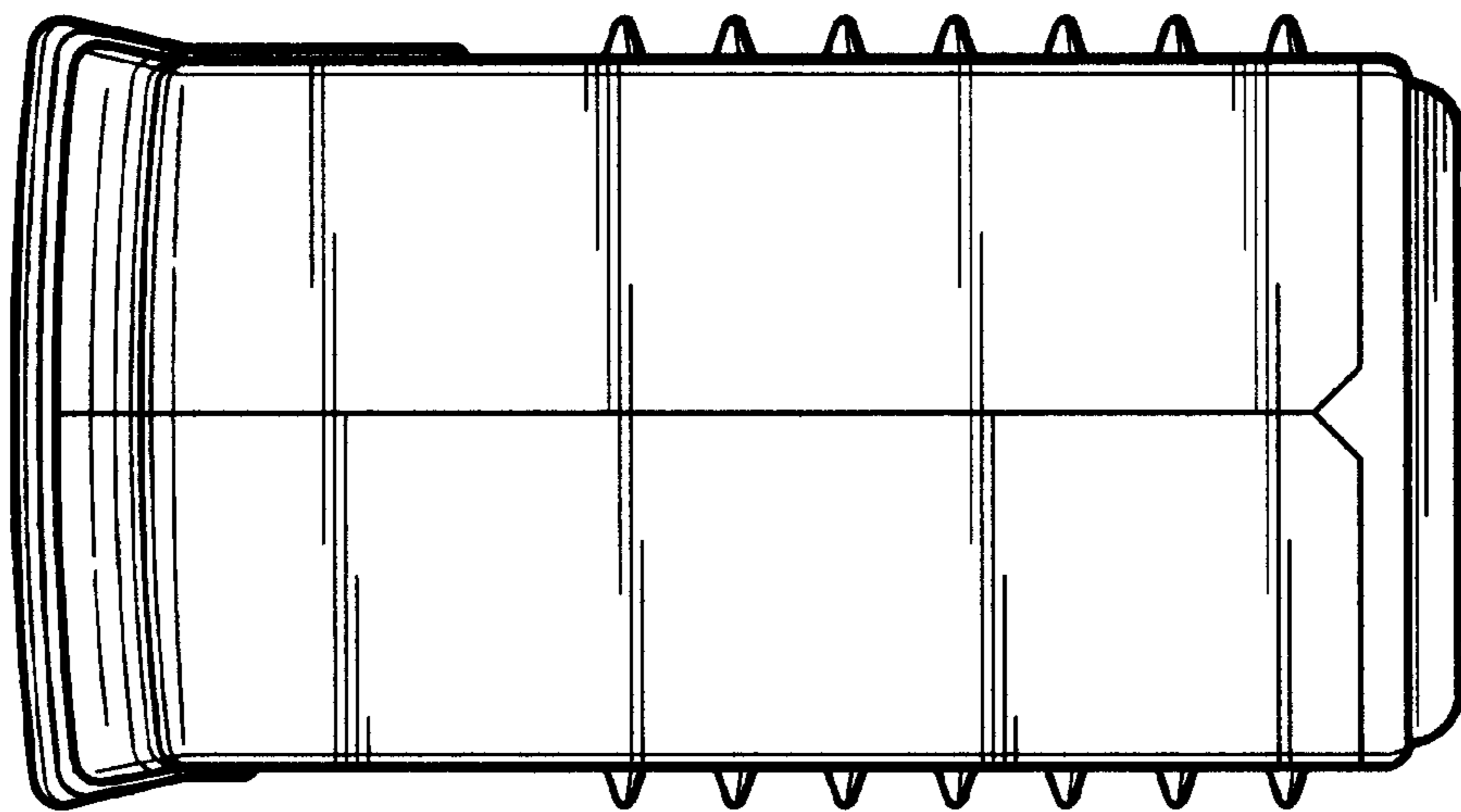

FIG. 6

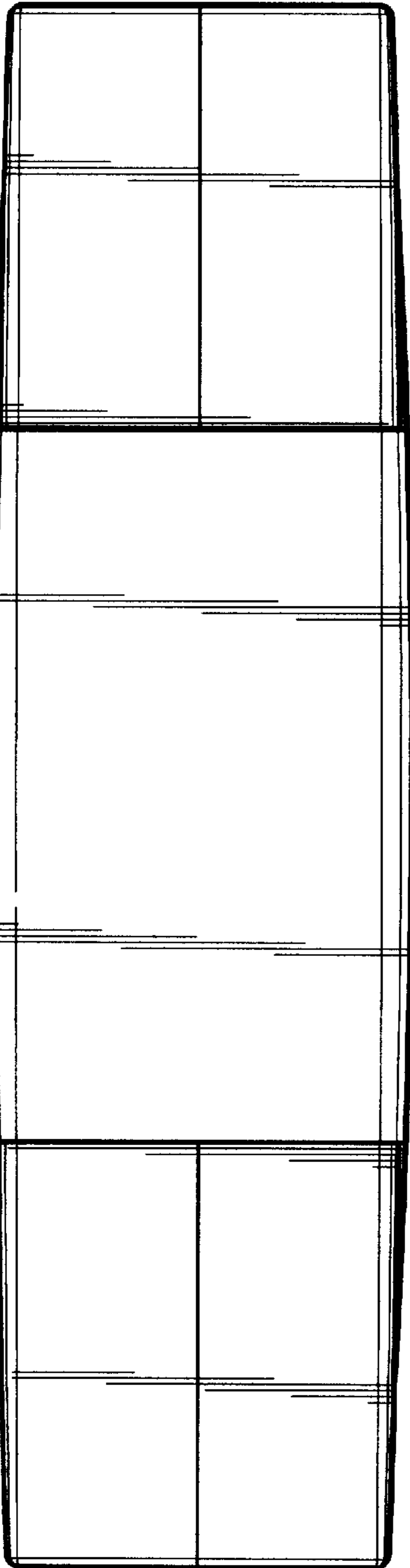

FIG. 7

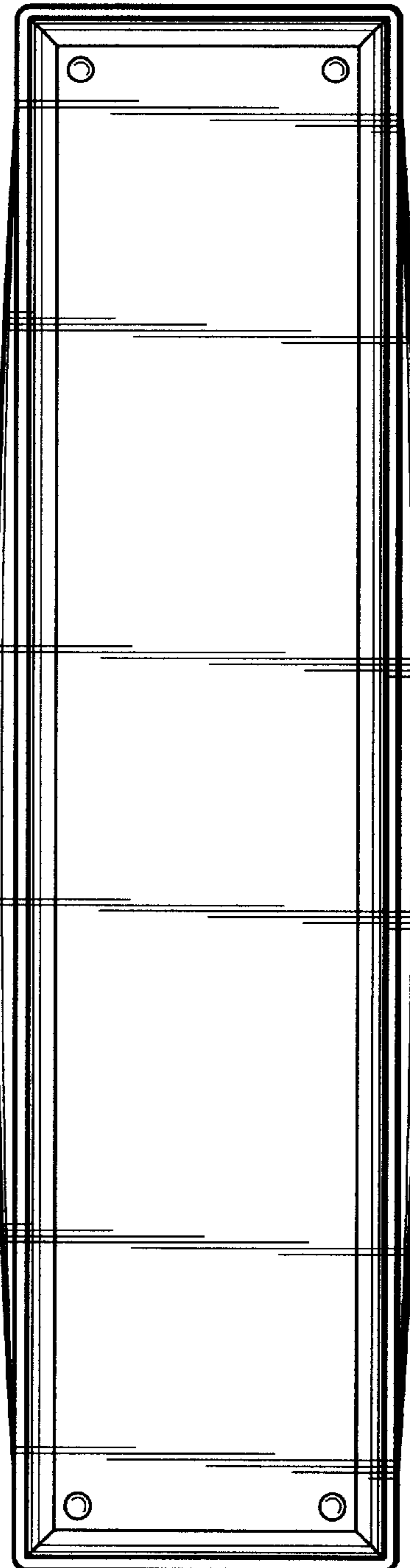

FIG. 8