



US00D455260S

(12) **United States Design Patent**
Eskandry

(10) **Patent No.:** **US D455,260 S**

(45) **Date of Patent:** **** Apr. 9, 2002**

(54) **COMBINED COMPACT DISC AND MULTI-MEDIA CARRYING CASE**

(74) *Attorney, Agent, or Firm*—Robert C. Kain, Jr.; Fleit, Kain

(76) **Inventor:** **Ezra D. Eskandry**, 1925 Brickell Ave., D901, Miami, FL (US) 33129

(57) **CLAIM**

(**) **Term:** **14 Years**

The ornamental design for the combined compact disc and multi-media carrying case, as shown.

(21) **Appl. No.:** **29/131,178**

DESCRIPTION

(22) **Filed:** **Oct. 16, 2000**

FIG. 1 is a perspective view of the combined compact disc and multi-media carrying case.

(51) **LOC (7) Cl.** **03-01**

FIG. 2 is a front, elevational view of the case.

(52) **U.S. Cl.** **D3/226**

FIG. 3 is a rear, elevational view of the case.

(58) **Field of Search** D3/218, 215, 224, D3/226, 201, 301; D6/407, 631-635; 206/308.1, 328, 387; 224/240, 245, 901, 904

FIG. 4 is a top view of the case.

FIG. 5 is a bottom view of the case.

FIG. 6 is a right side view of the case.

FIG. 7 is a left side view of the case.

(56) **References Cited**

FIG. 8 is a perspective view of the combined compact disc and multi-media carrying case attached to a hip belt.

U.S. PATENT DOCUMENTS

FIG. 9 is a front, elevational view of the case mounted on the hip belt.

D393,363 S	*	4/1998	Kataoka	D3/215
D418,287 S	*	1/2000	Moor	D3/201
D428,700 S	*	8/2000	Hillman	D3/215 X
D430,205 S		8/2000	Eskandry	D19/33
D430,397 S		9/2000	Eskandry	D3/290
D432,344 S	*	10/2000	Eskandry	D6/632
D434,897 S	*	12/2000	Hillman	D3/218
D435,385 S	*	12/2000	Eskandry	D6/633
D436,723 S	*	1/2001	Ankri	D3/218

FIG. 10 is a rear, elevational view of the case mounted on the hip belt.

FIG. 11 is a left side view of the case mounted on the hip belt.

FIG. 12 is a right side view of the case mounted on the hip belt.

* cited by examiner

FIG. 13 is a top view of the case mounted on the hip belt; and,

FIG. 14 is a bottom view of the case mounted on the hip belt.

Primary Examiner—Catherine R. Oliver

1 Claim, 11 Drawing Sheets

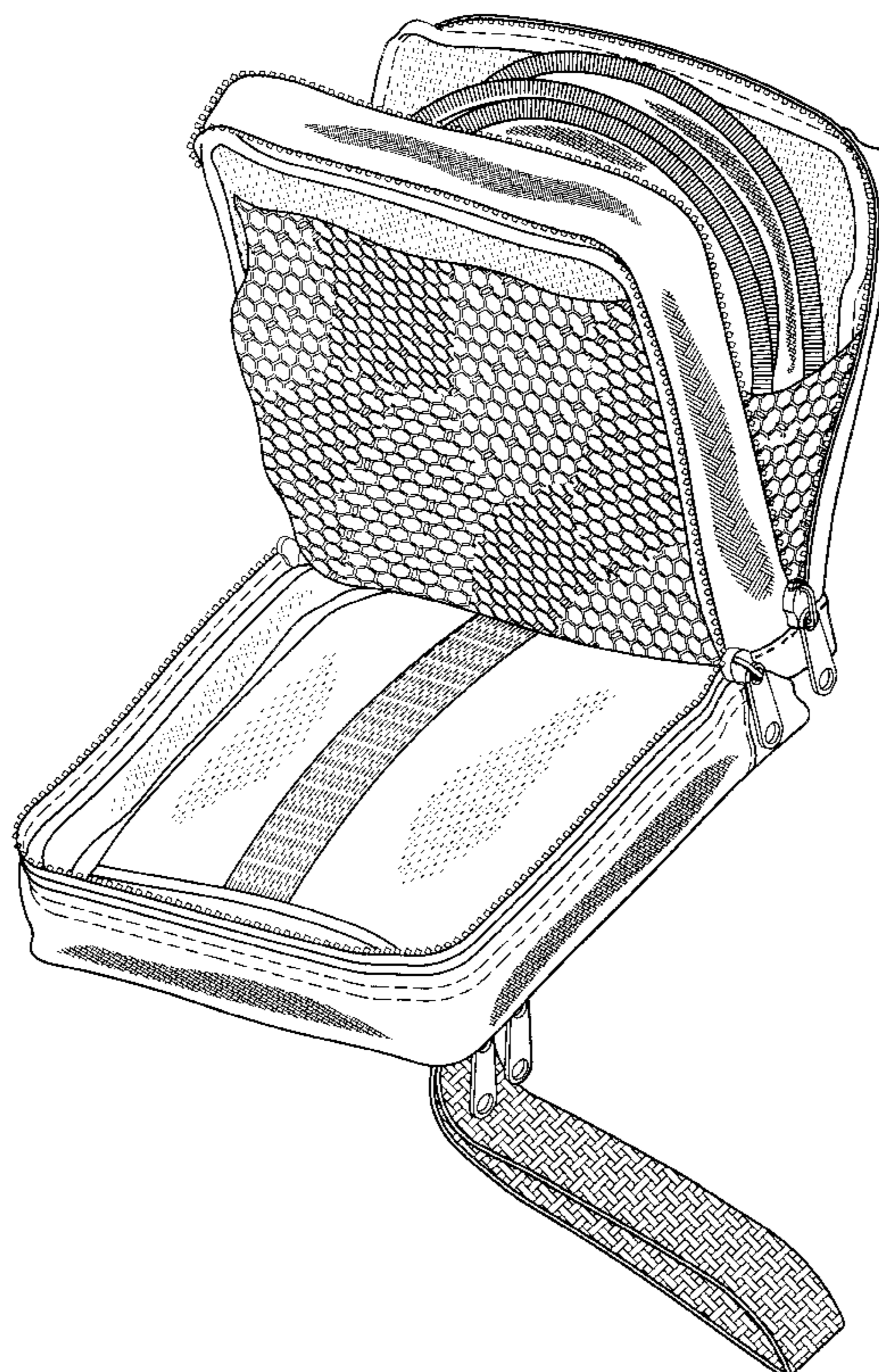

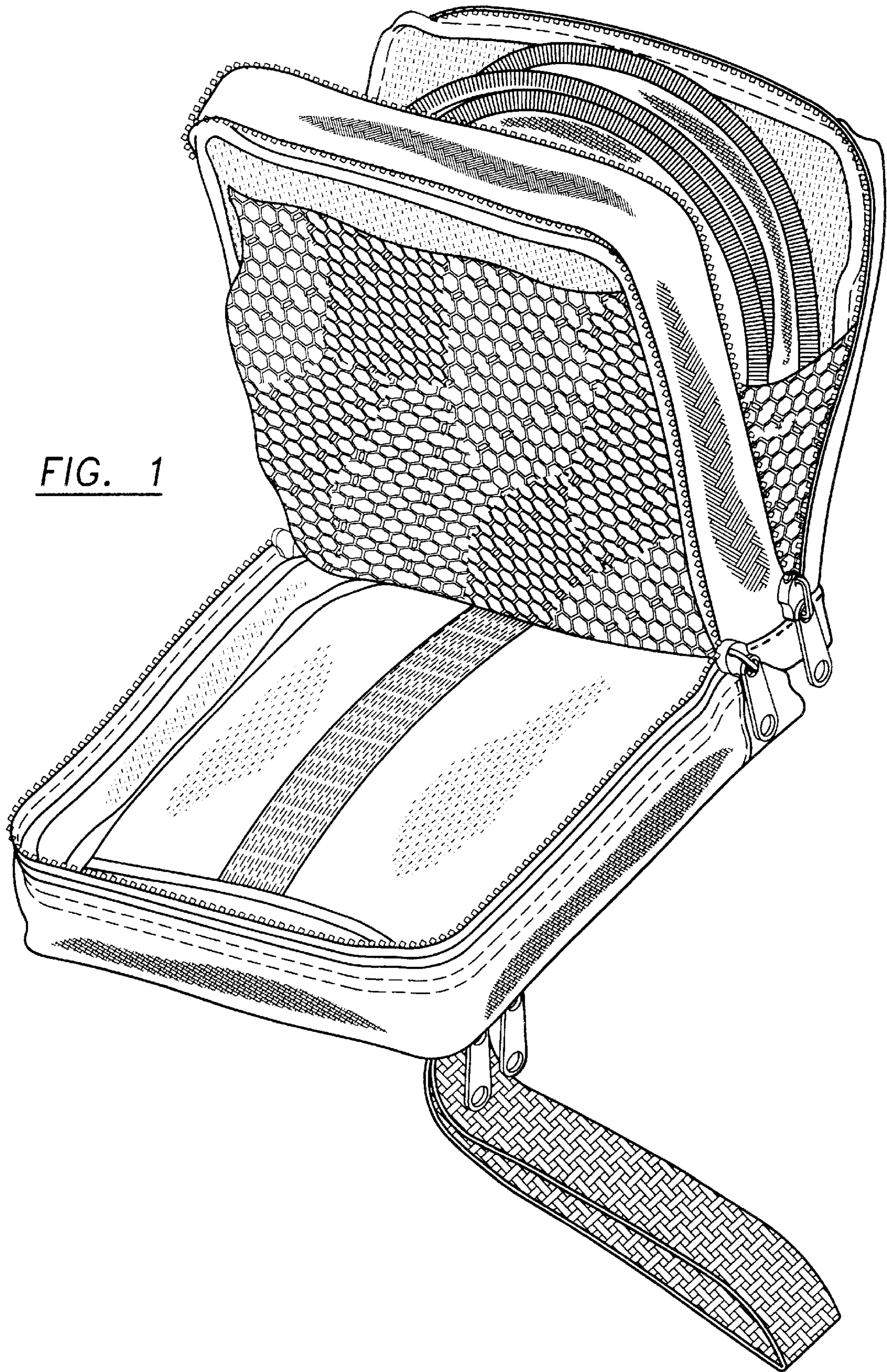

FIG. 1

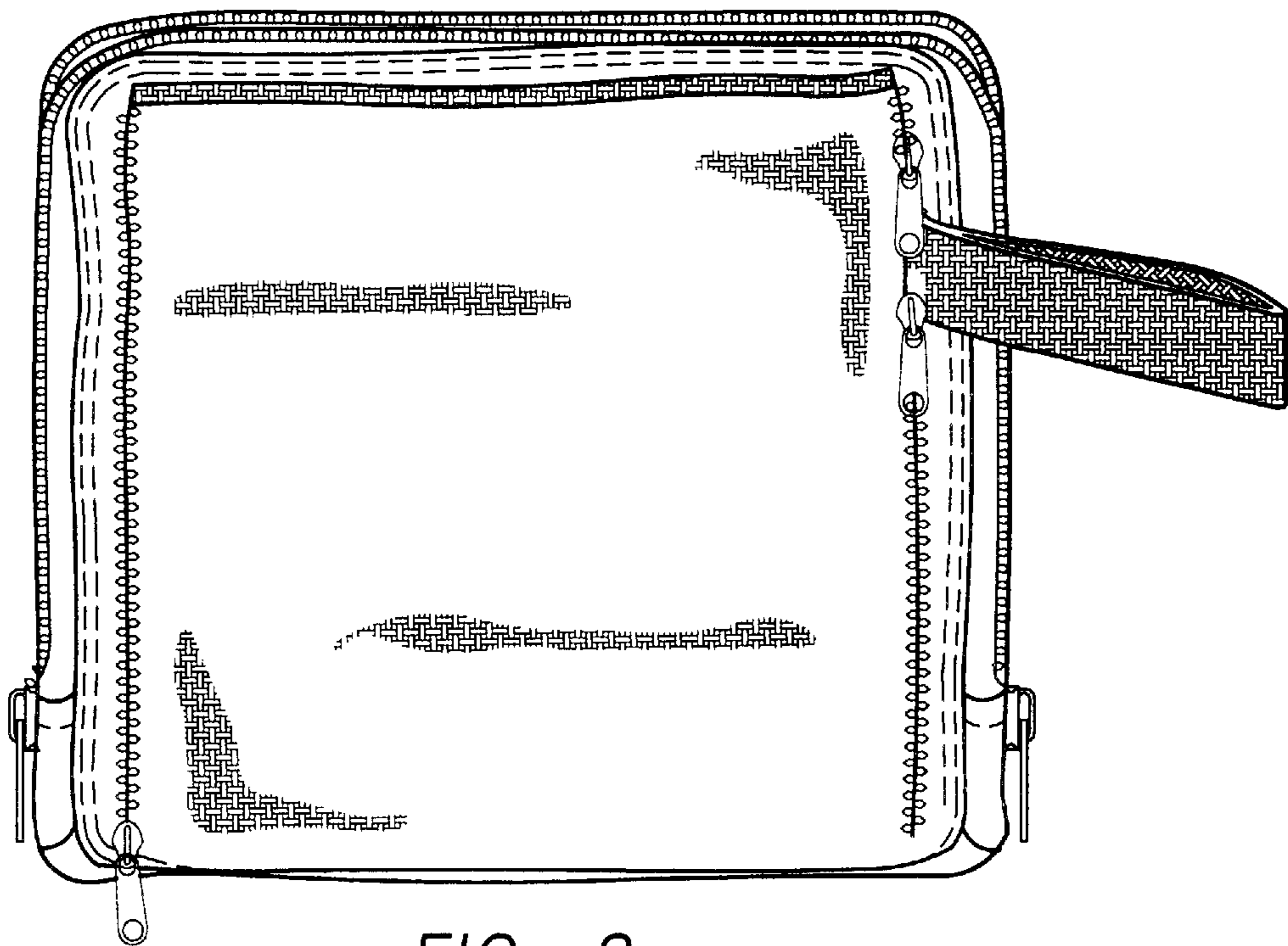

FIG. 2

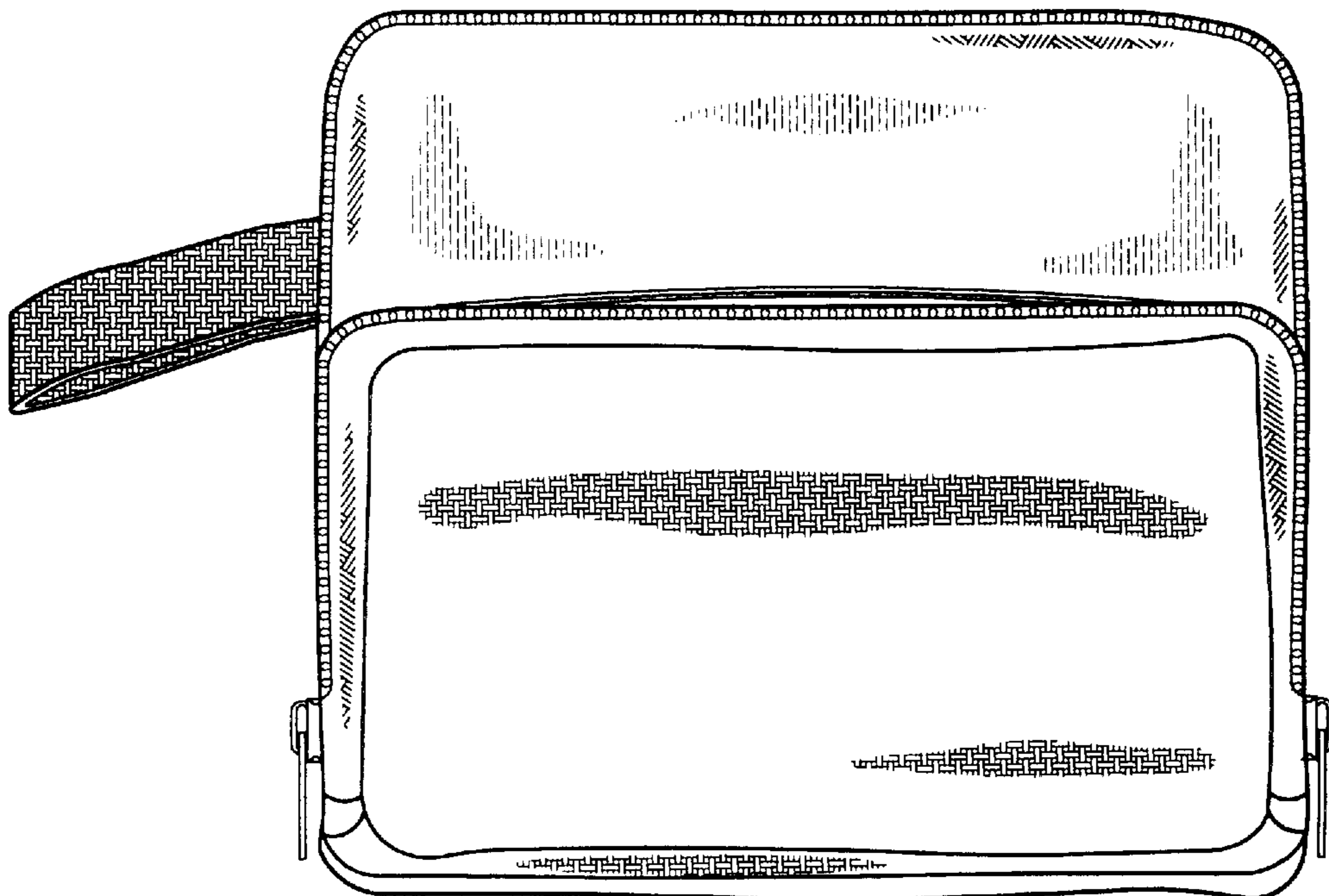

FIG. 3

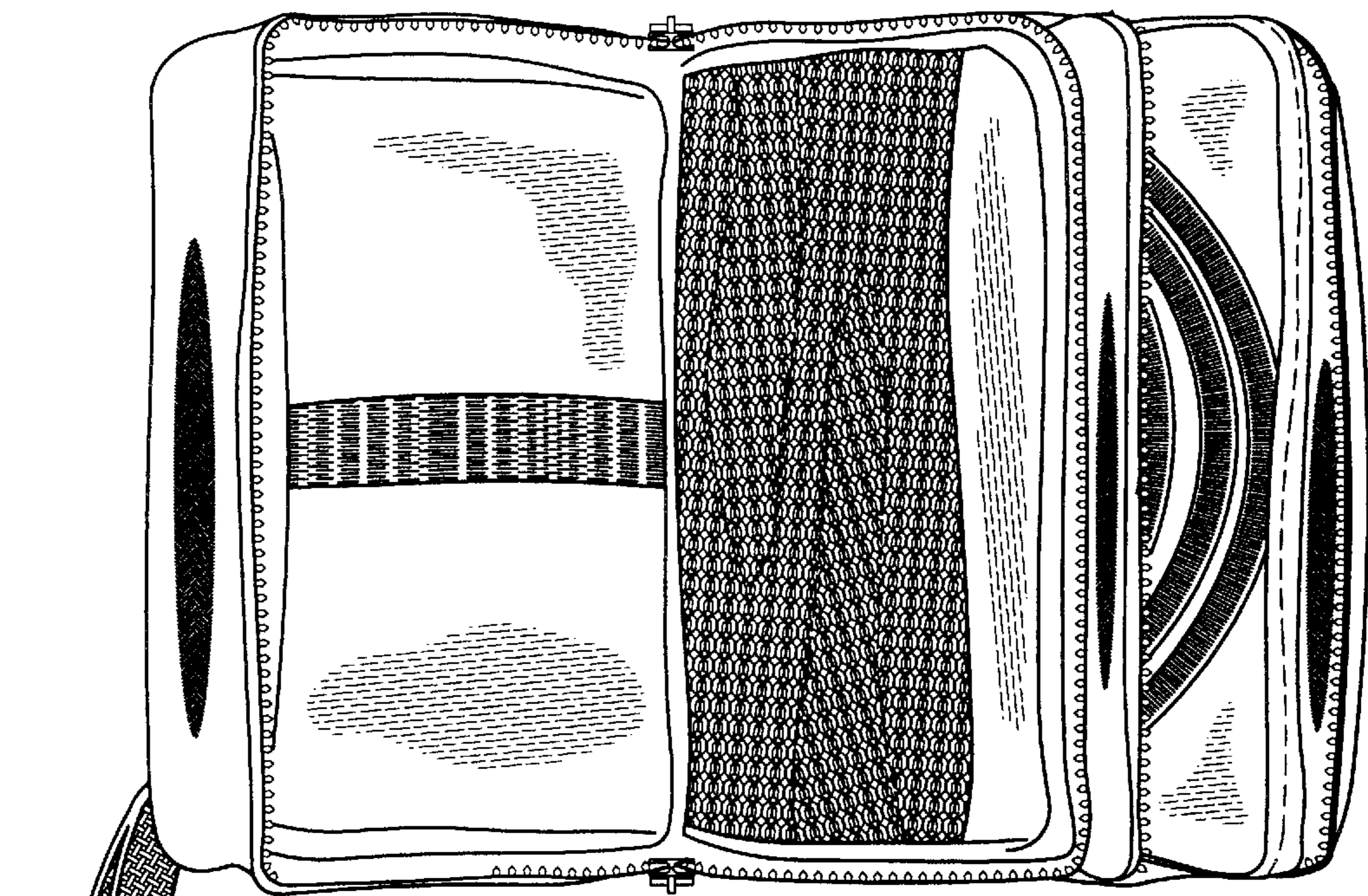

FIG. 4

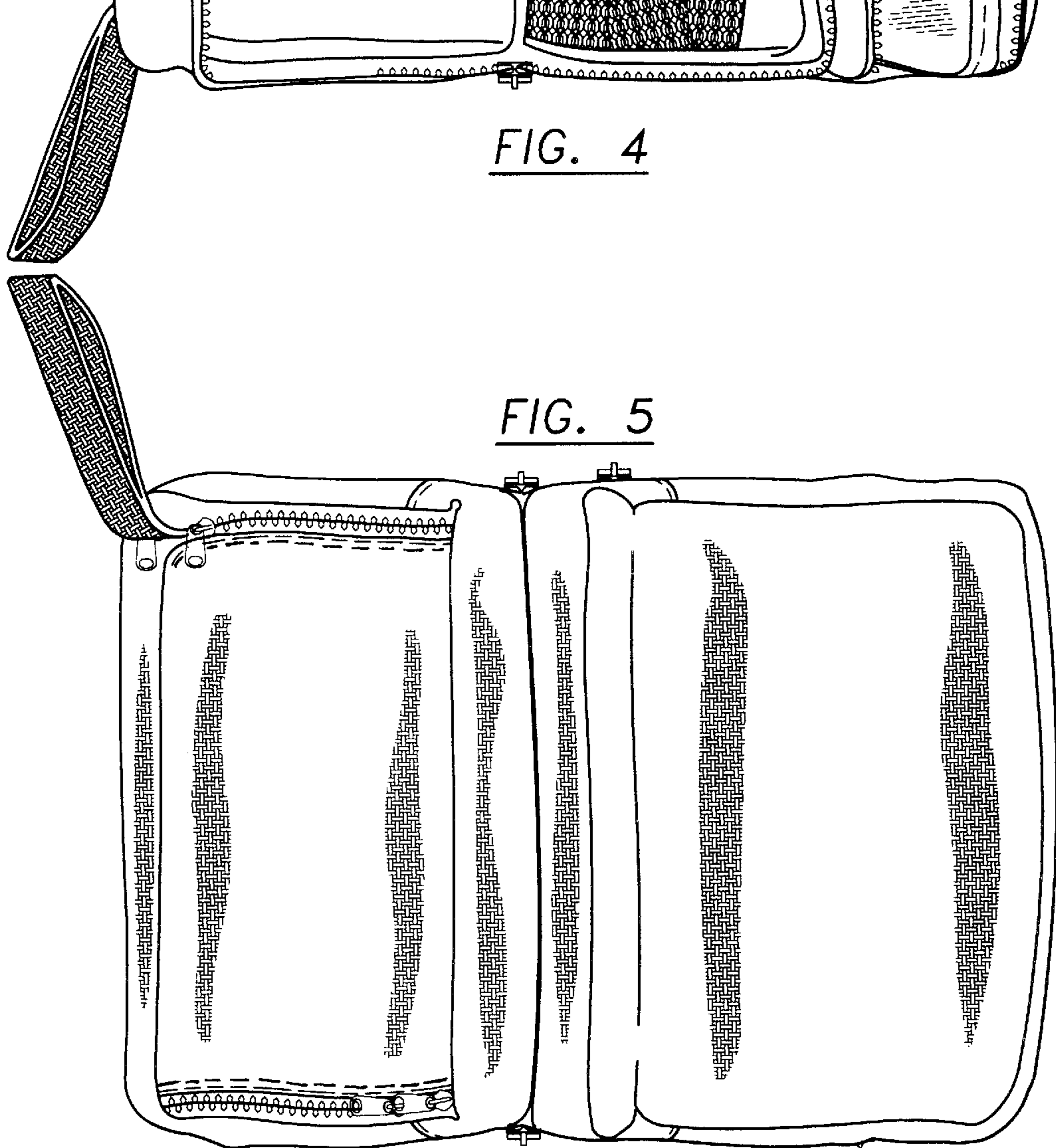

FIG. 5

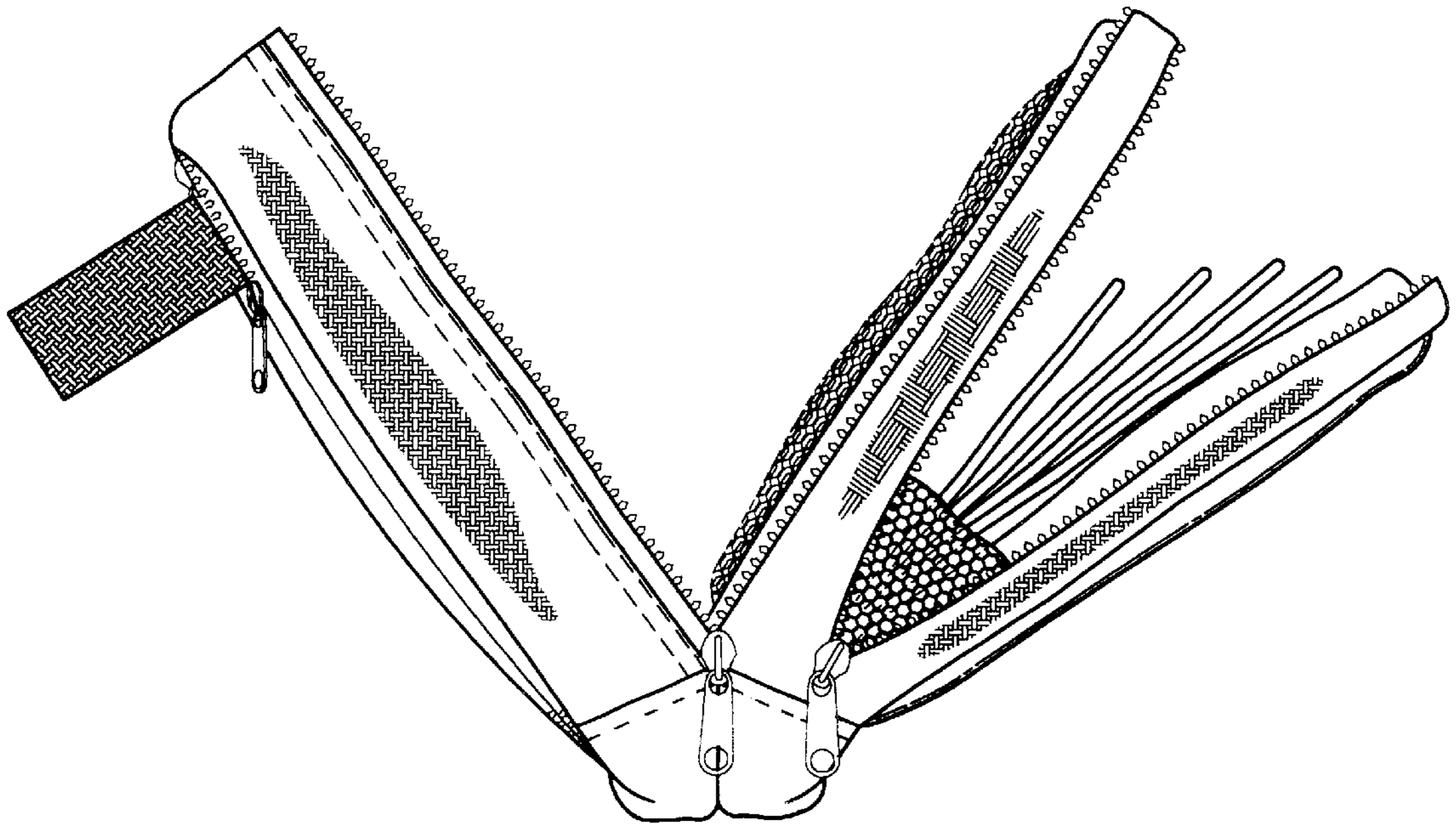

FIG. 6

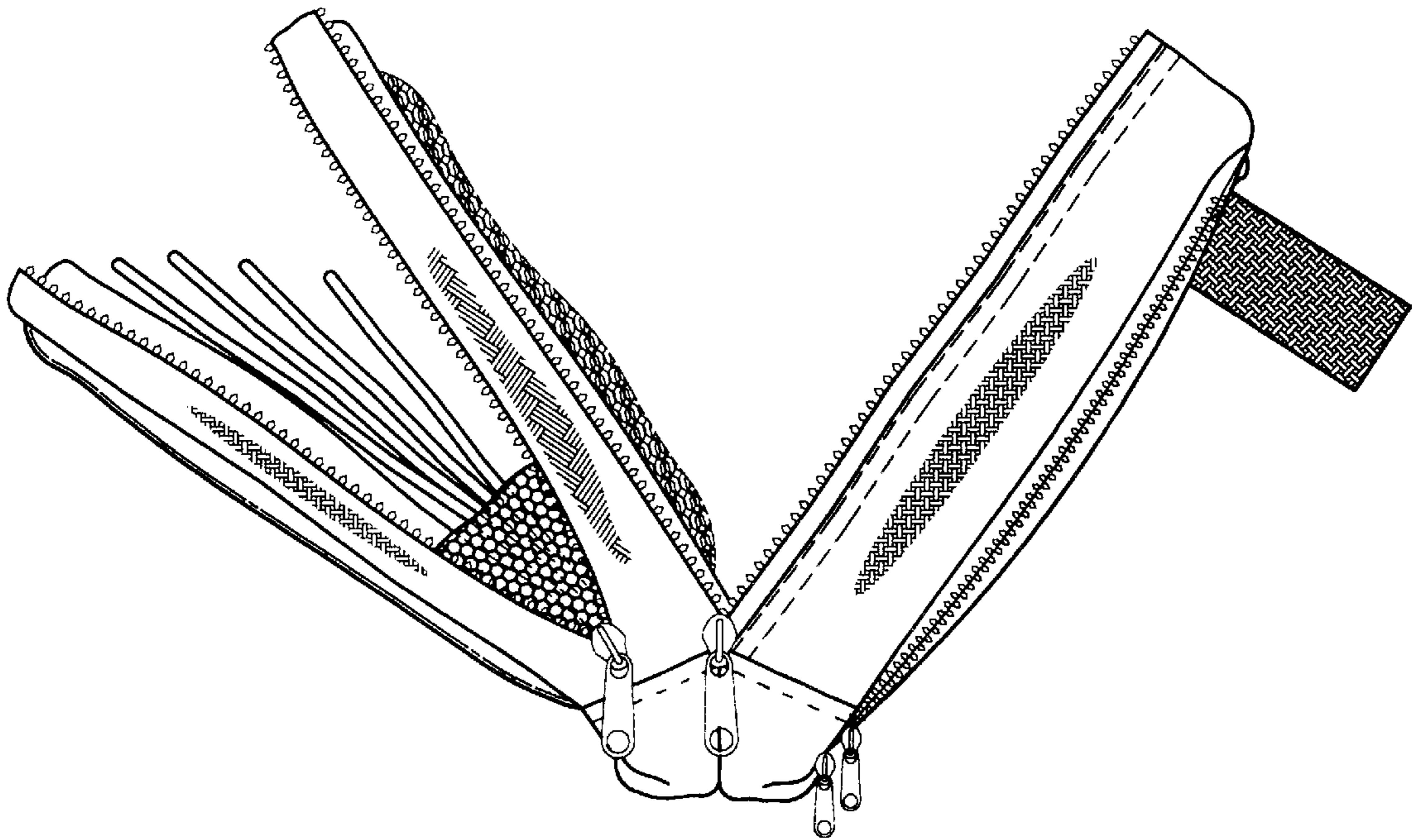

FIG. 7

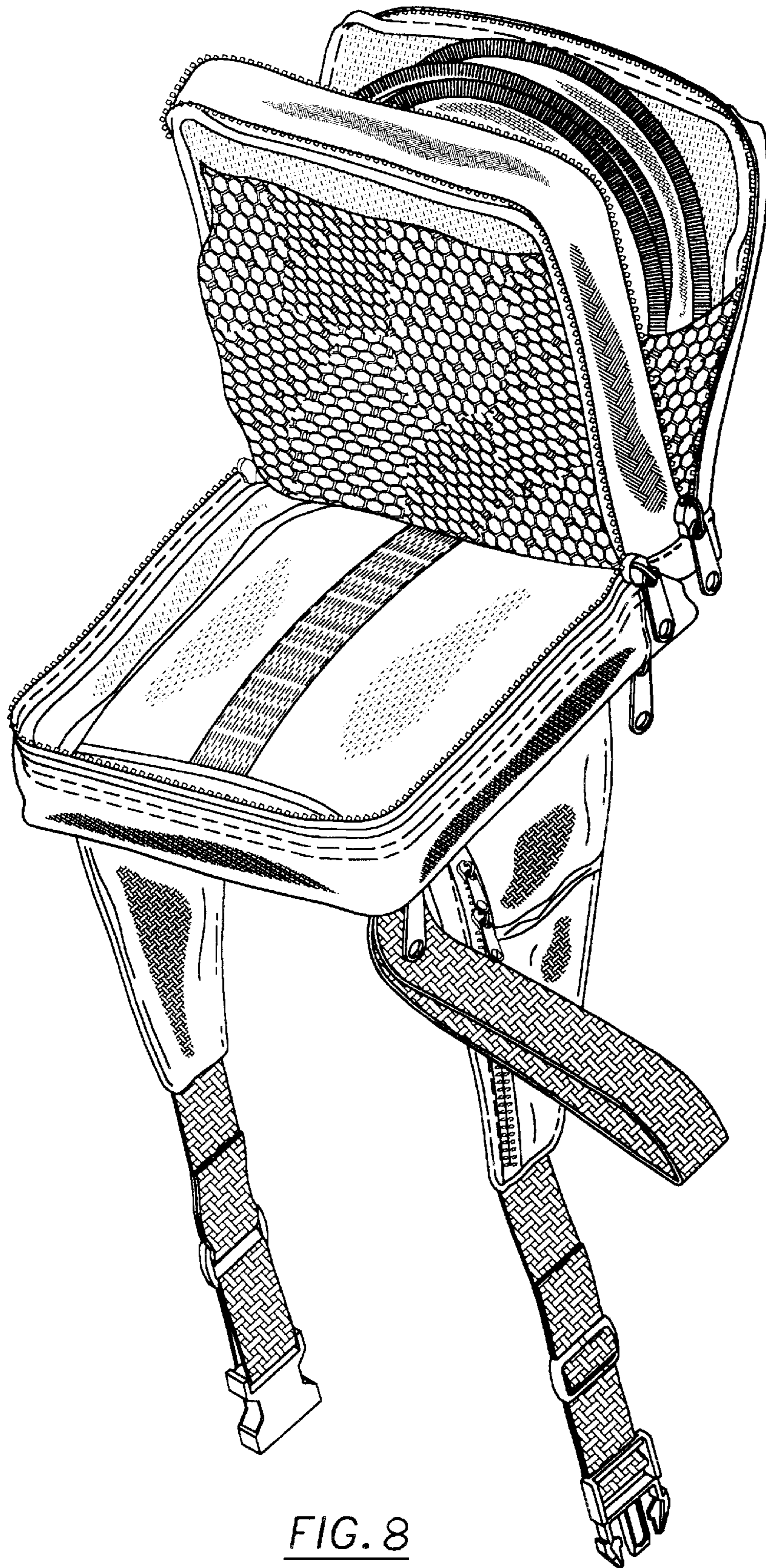

FIG. 8

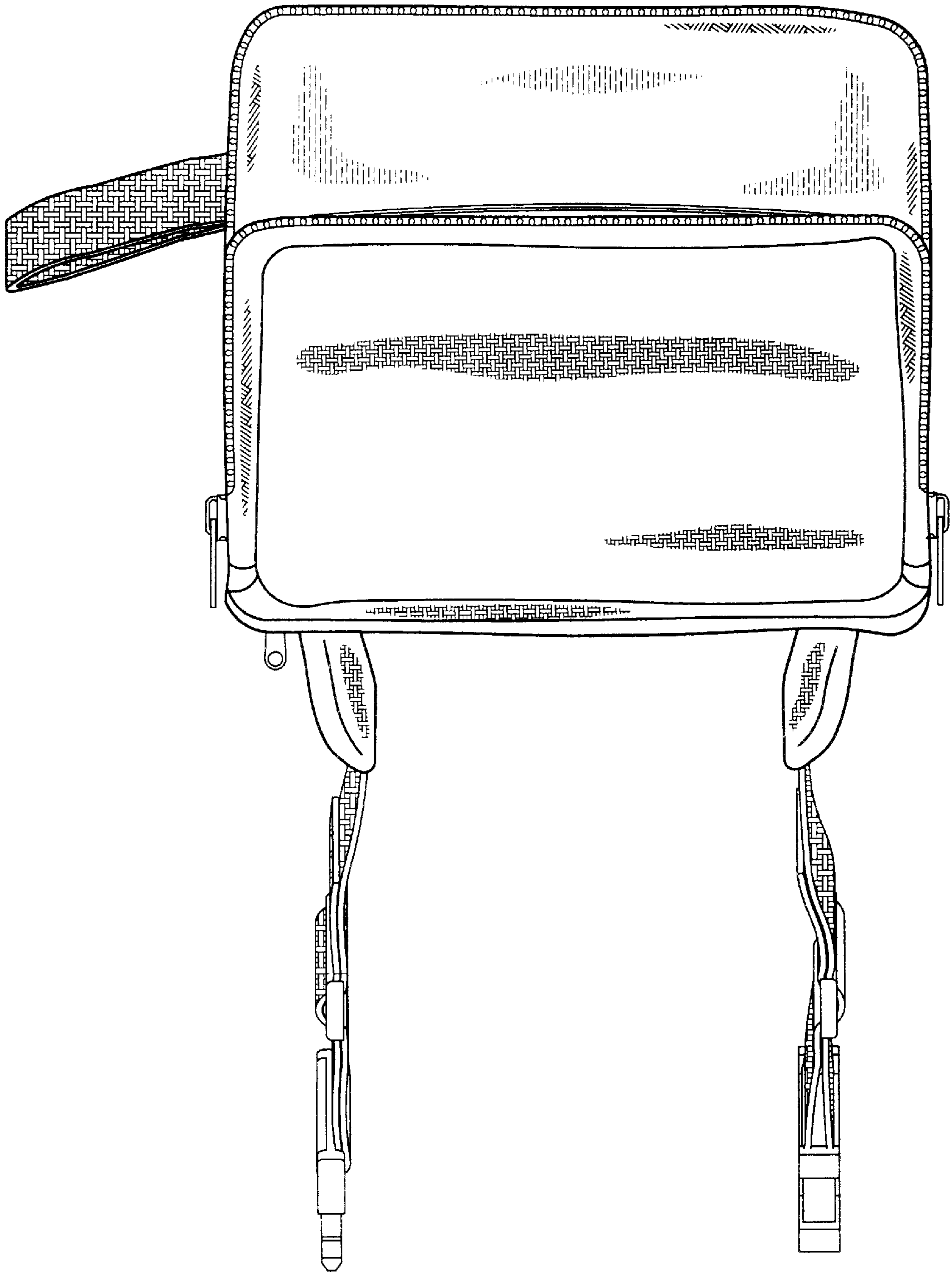

FIG. 9

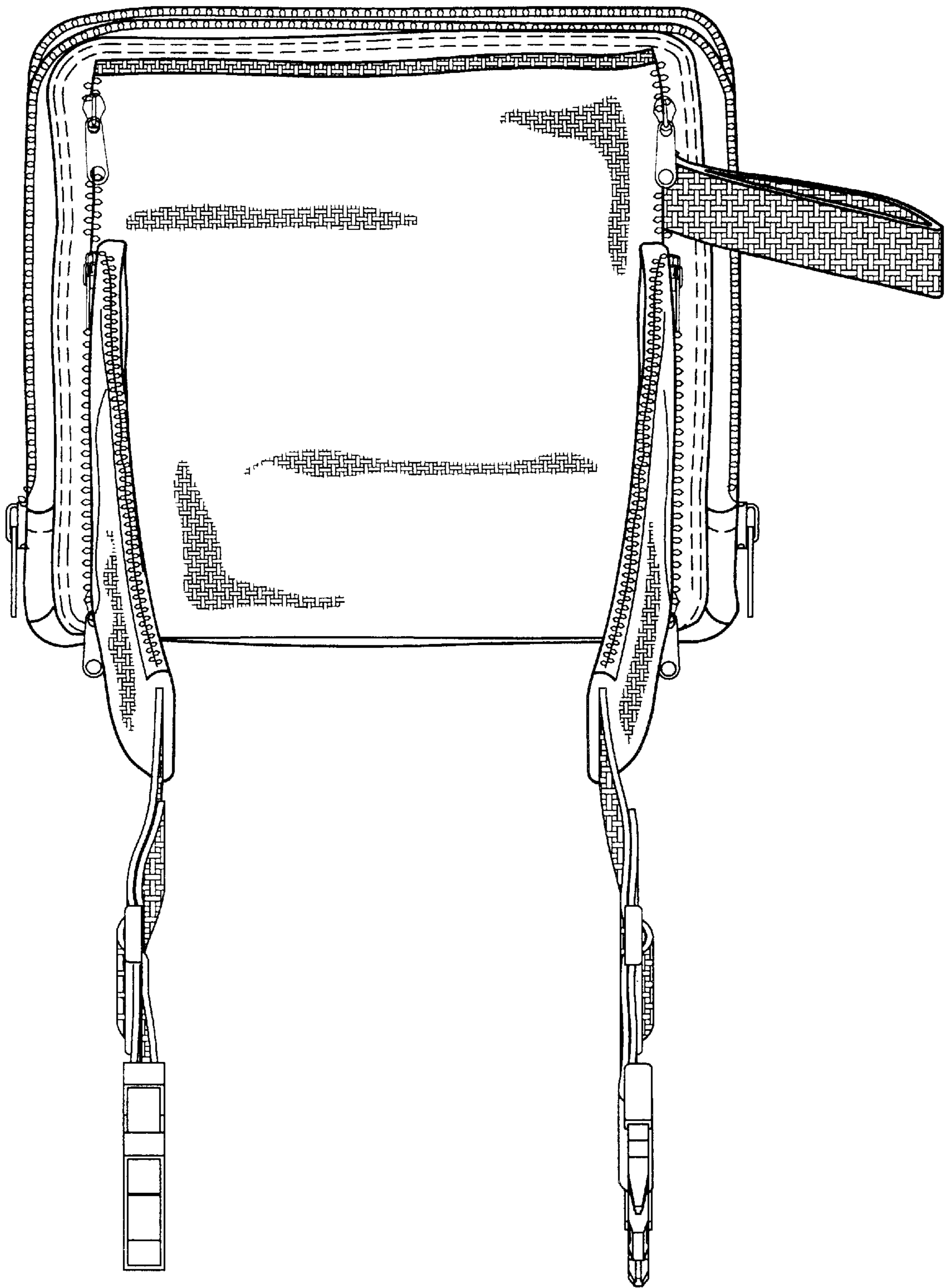

FIG. 10

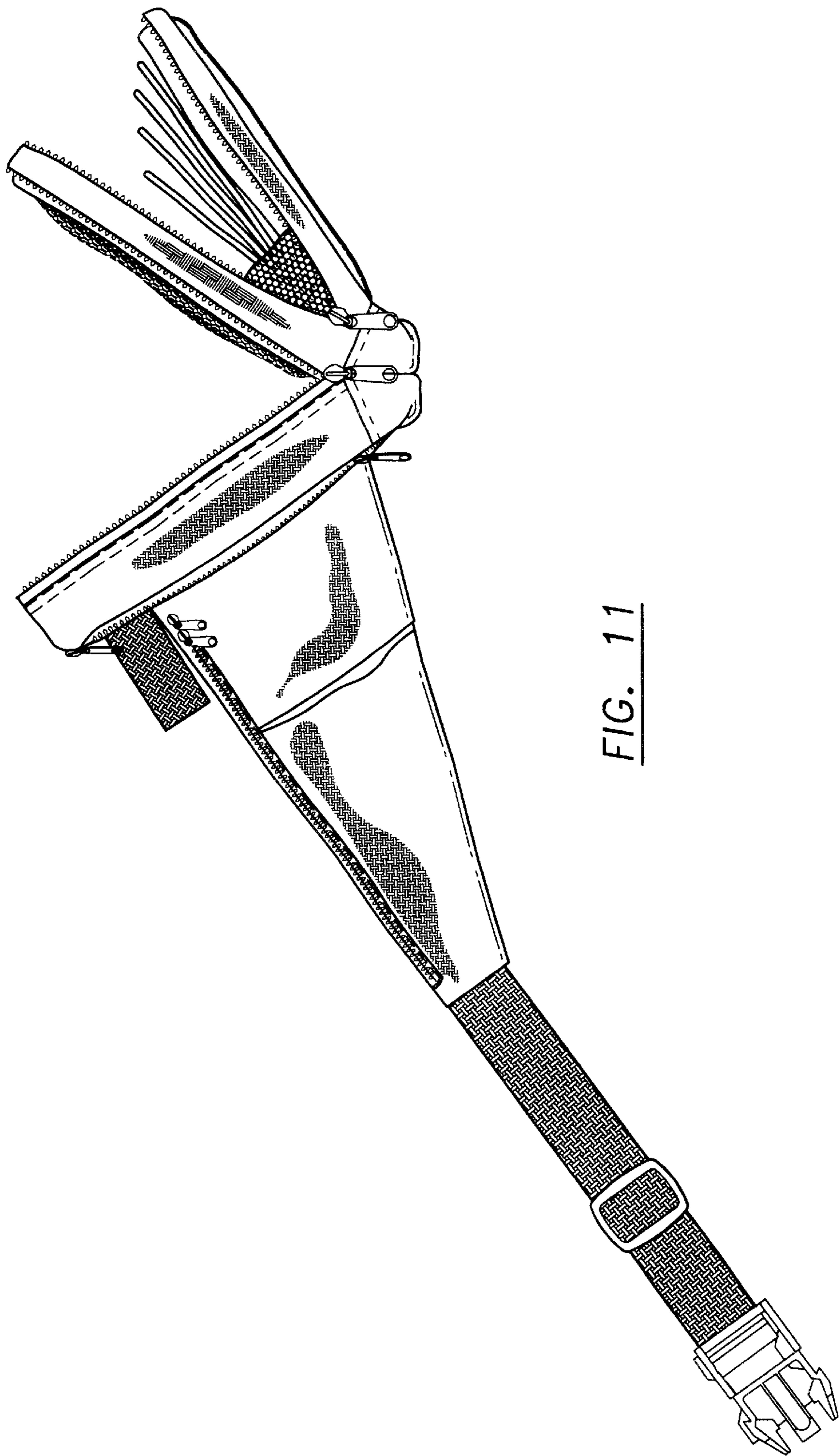

FIG. 11

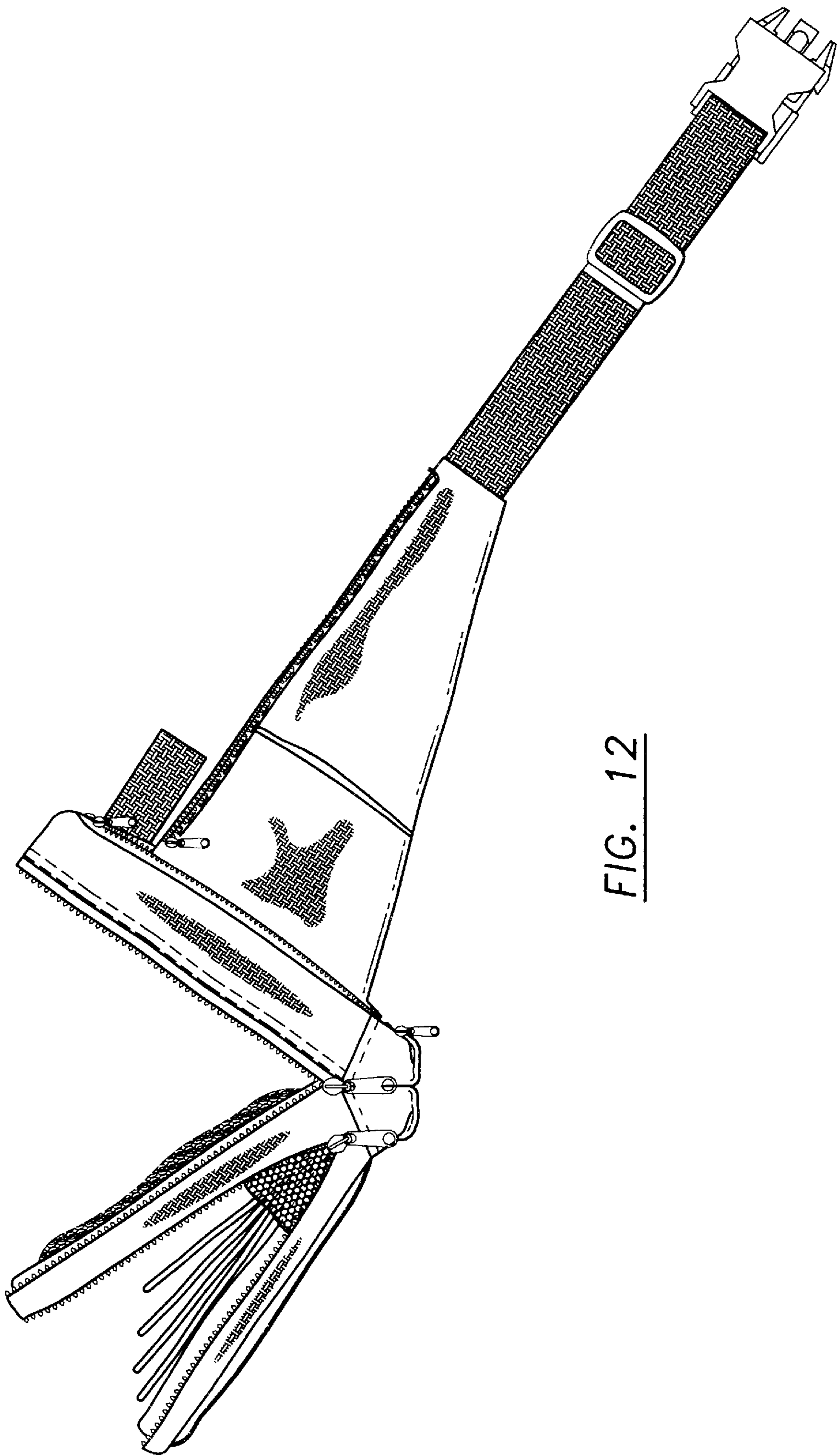

FIG. 12

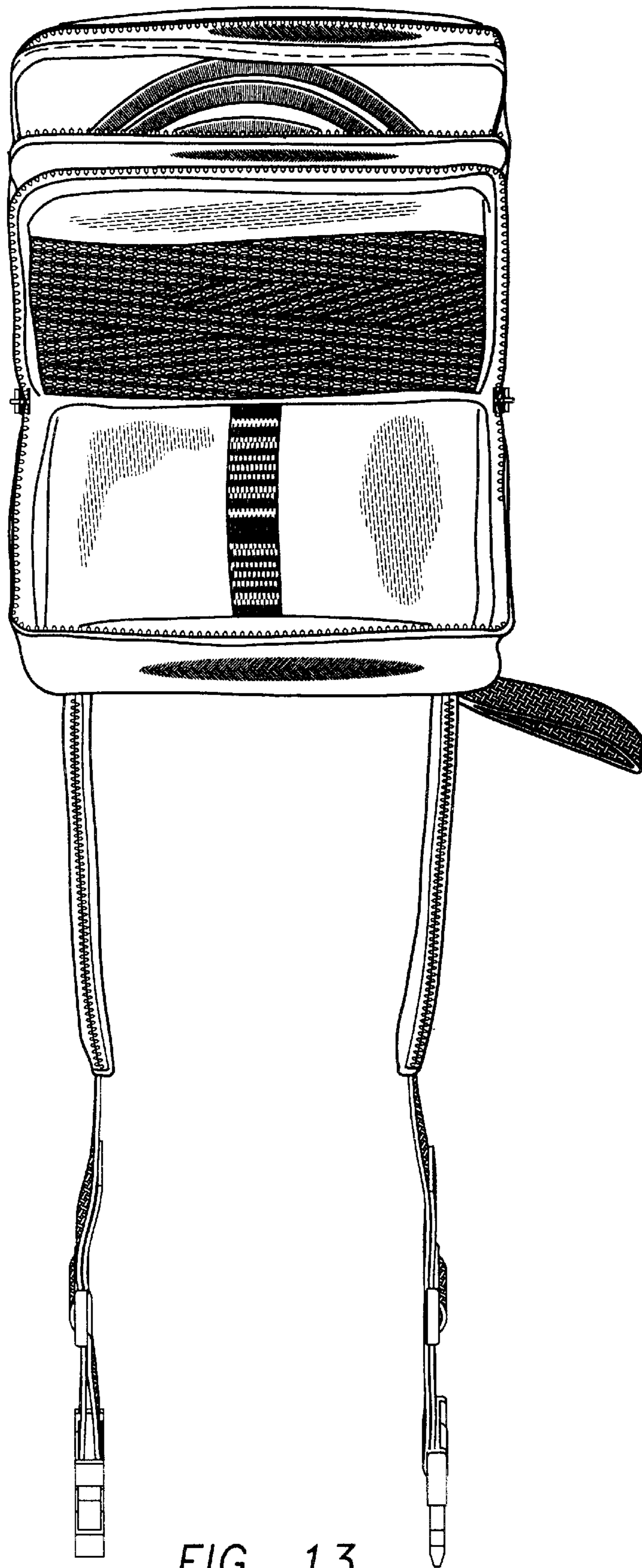

FIG. 13

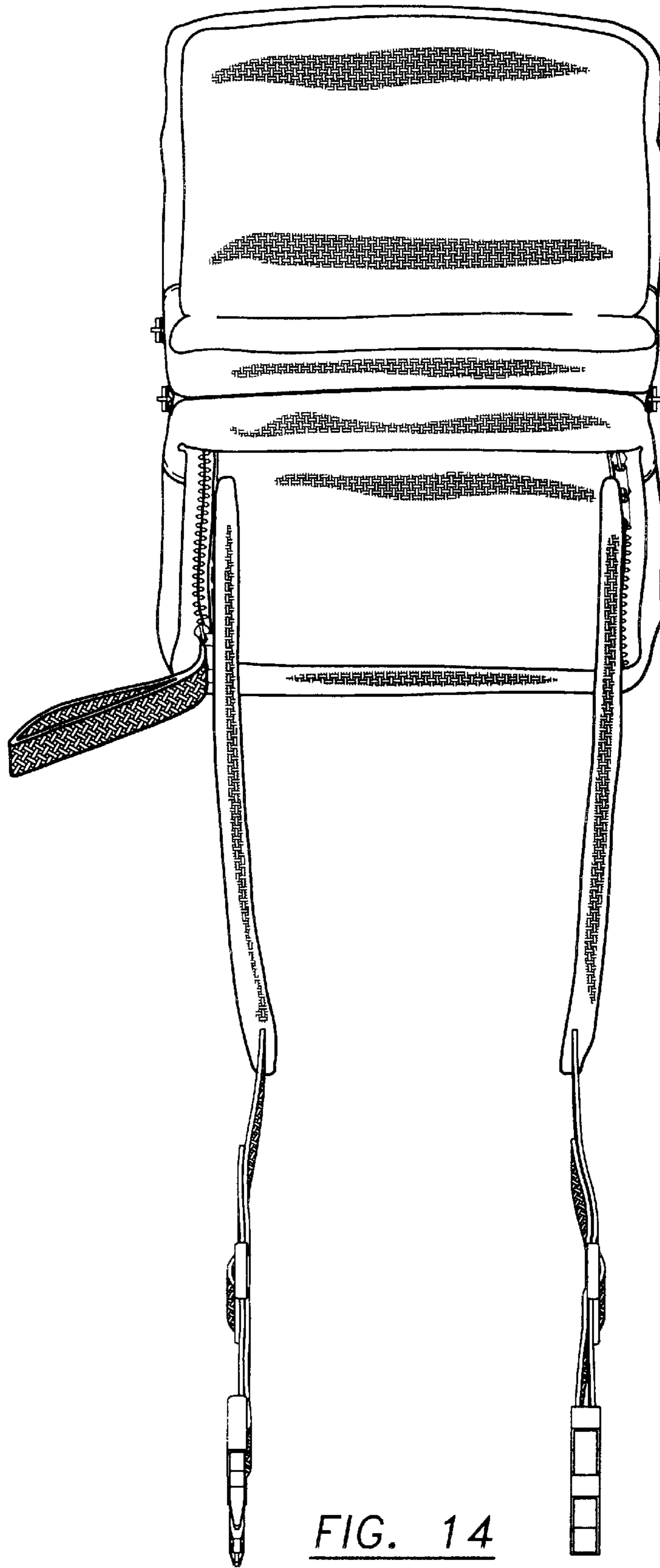

FIG. 14