

US00D455230S

(12) **United States Design Patent**  
**Lau**

(10) **Patent No.:** **US D455,230 S**

(45) **Date of Patent:** **\*\* Apr. 2, 2002**

(54) **HAIR CLIPPER**

(75) Inventor: **Tung Yan Yen Lau**, Shatin (CN)  
(73) Assignee: **Specialife Industries Ltd.**, Shatin (CN)  
(\*\*) Term: **14 Years**

(21) Appl. No.: **29/141,760**  
(22) Filed: **May 11, 2001**

(51) **LOC (7) Cl.** ..... **28-03**  
(52) **U.S. Cl.** ..... **D28/53**  
(58) **Field of Search** ..... D28/49-54; 30/34.05,  
30/34.1, 34.2, 42, 43, 43.1-43.9, 43.91,  
43.92, 44, 45, 195-223

(56) **References Cited**

**U.S. PATENT DOCUMENTS**

3,031,758	A	*	5/1962	Wahl	.....	30/201
5,084,974	A	*	2/1992	Sukow et al.	.....	30/201
D340,783	S	*	10/1993	McCambridge	.....	D28/53
D369,230	S	*	4/1996	Bone	.....	D28/53
D408,102	S	*	4/1999	Van Asten	.....	D28/53
D424,242	S	*	5/2000	Picozza et al.	.....	D28/53
D435,936	S	*	1/2001	Long et al.	.....	D28/53
D437,088	S	*	1/2001	Wursthorn	.....	D28/53

**FOREIGN PATENT DOCUMENTS**

GB DES. 2080310 \* 9/1998 ..... 28/3

**OTHER PUBLICATIONS**

Hong Kong Enterprise Oct. 1996, p. 667: item Nos. SF-828 and SF-968.\*

\* cited by examiner

*Primary Examiner*—Ted Shooman

*Assistant Examiner*—C. Tuttle

(74) *Attorney, Agent, or Firm*—Alix, Yale & Ristas, LLP

(57) **CLAIM**

The ornamental design for a hair clipper, as shown and described.

**DESCRIPTION**

FIG. 1 is a front perspective view of the hair clipper showing my new design;

FIG. 2 is a front view of the hair clipper of FIG. 1;

FIG. 3 is a top plan view of the hair clipper of FIG. 1;

FIG. 4 is a left side view of the hair clipper of FIG. 1;

FIG. 5 is a right side view of the hair clipper of FIG. 1;

FIG. 6 is a rear view of the hair clipper of FIG. 1; and,

FIG. 7 is a bottom plan view of the hair clipper of FIG. 1.

The cord portion partially illustrated by broken lines in FIGS. 1-3, 5 and 6 forms no part of the claimed design.

**1 Claim, 4 Drawing Sheets**

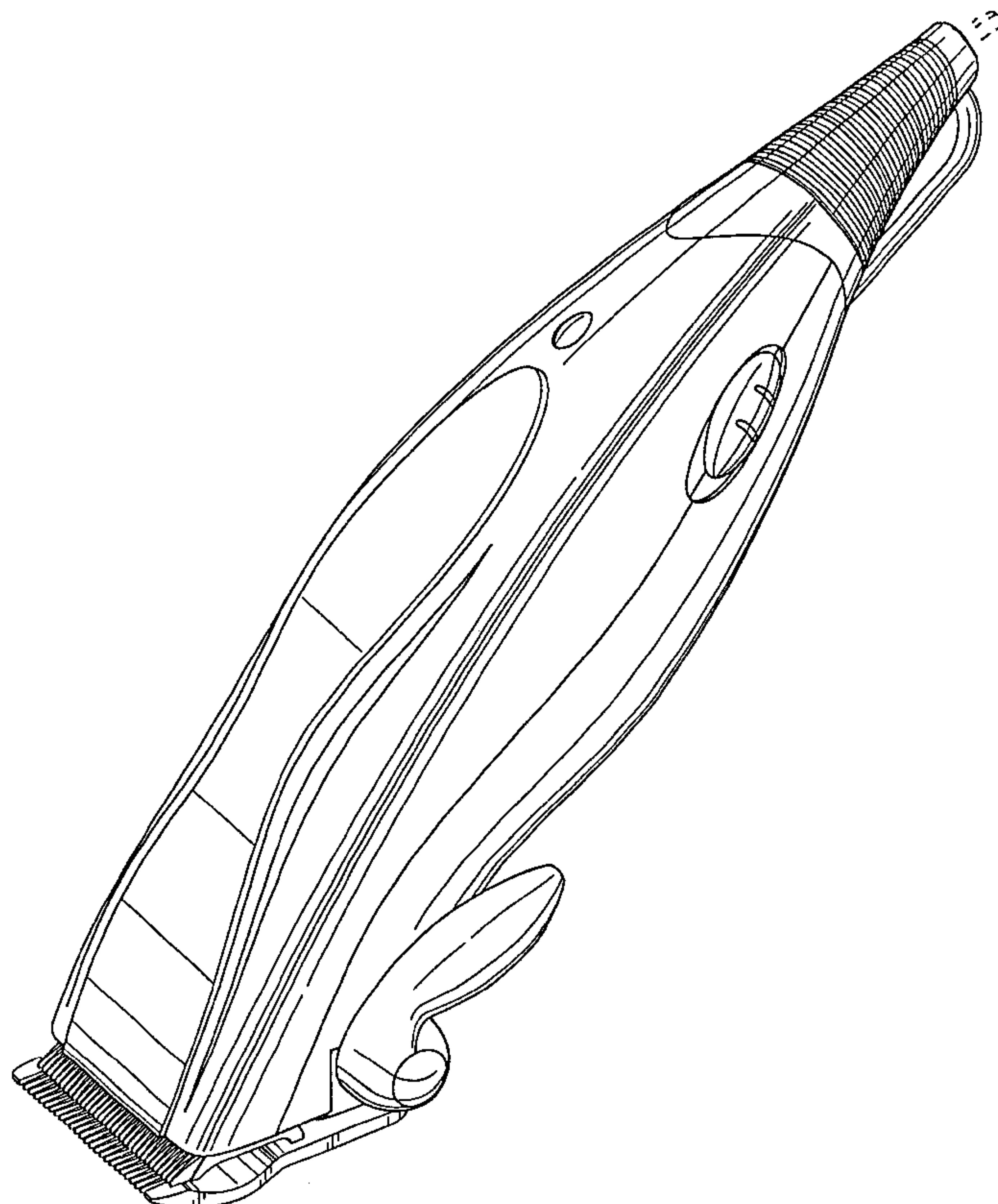

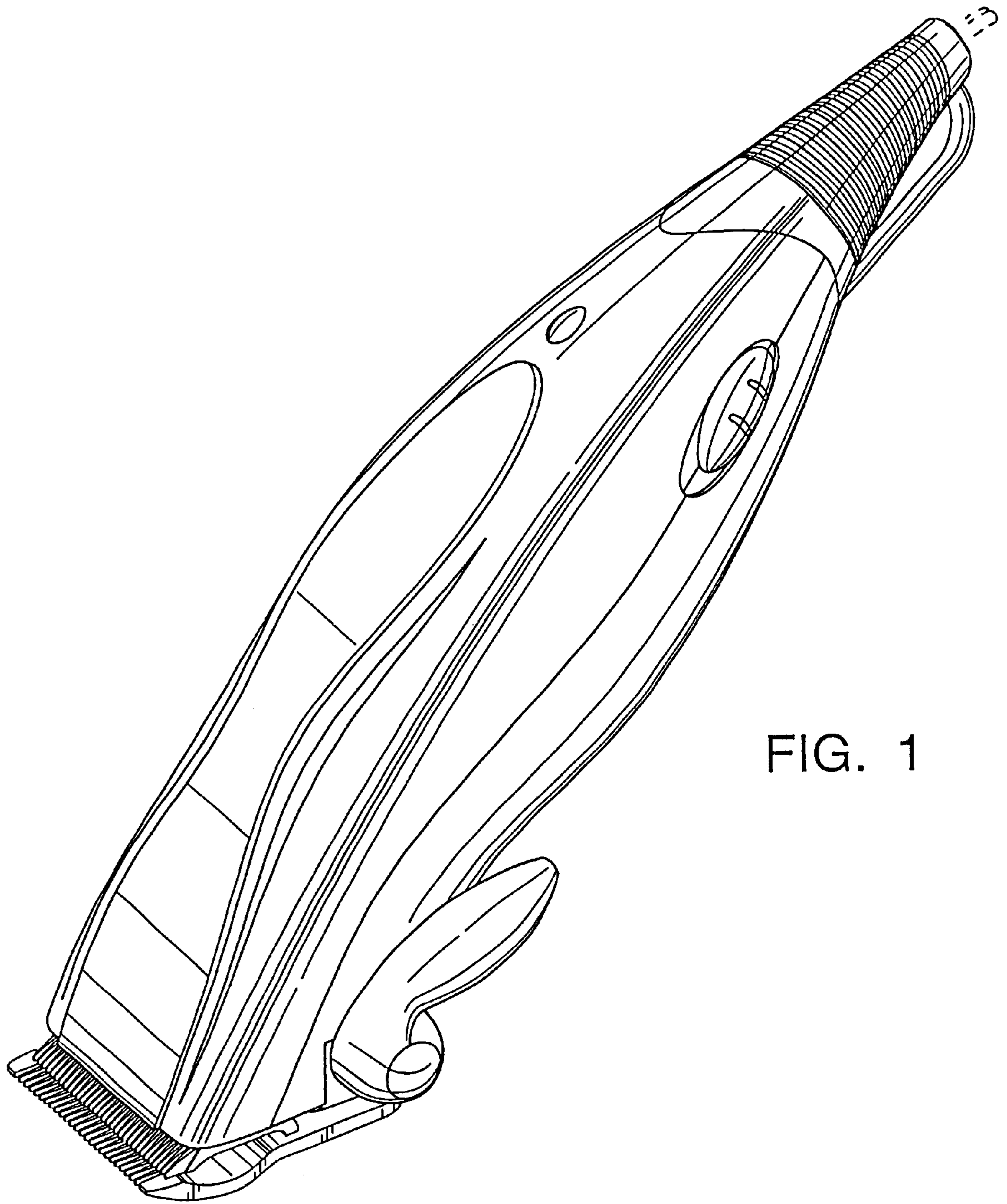

FIG. 1

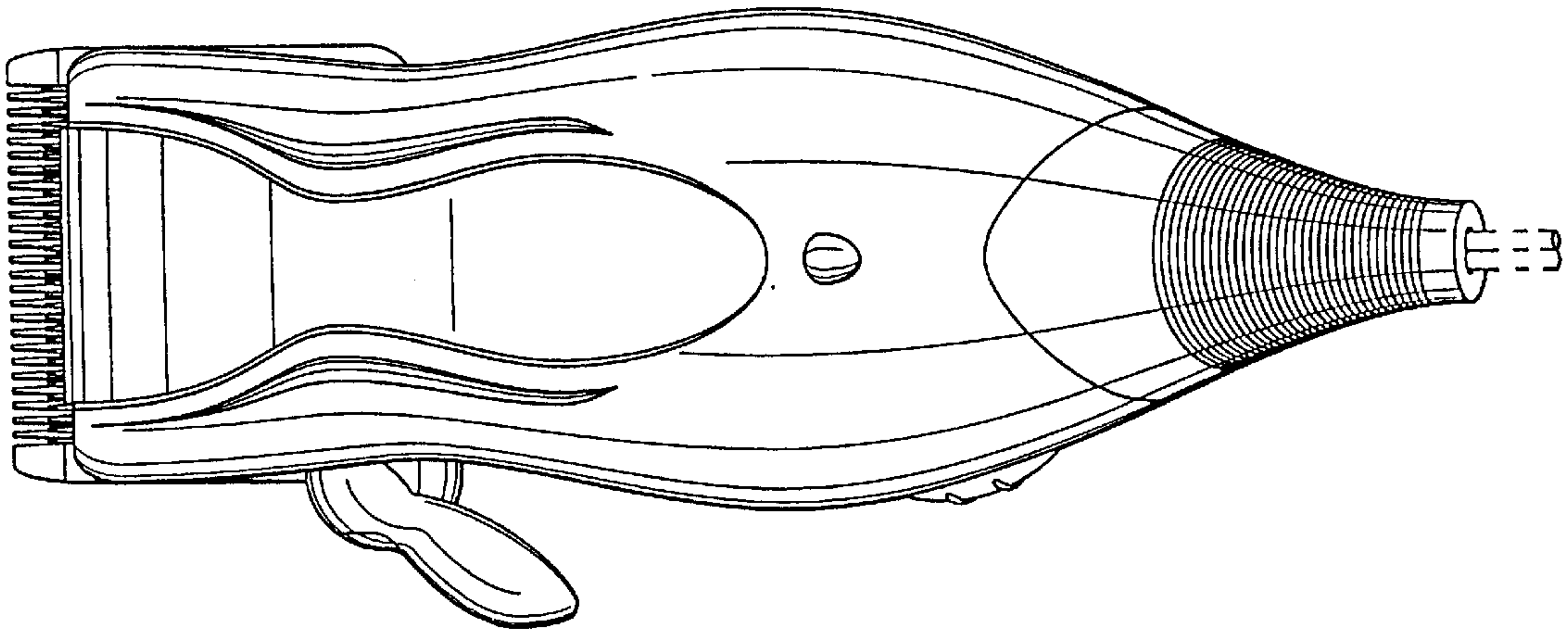

FIG. 3

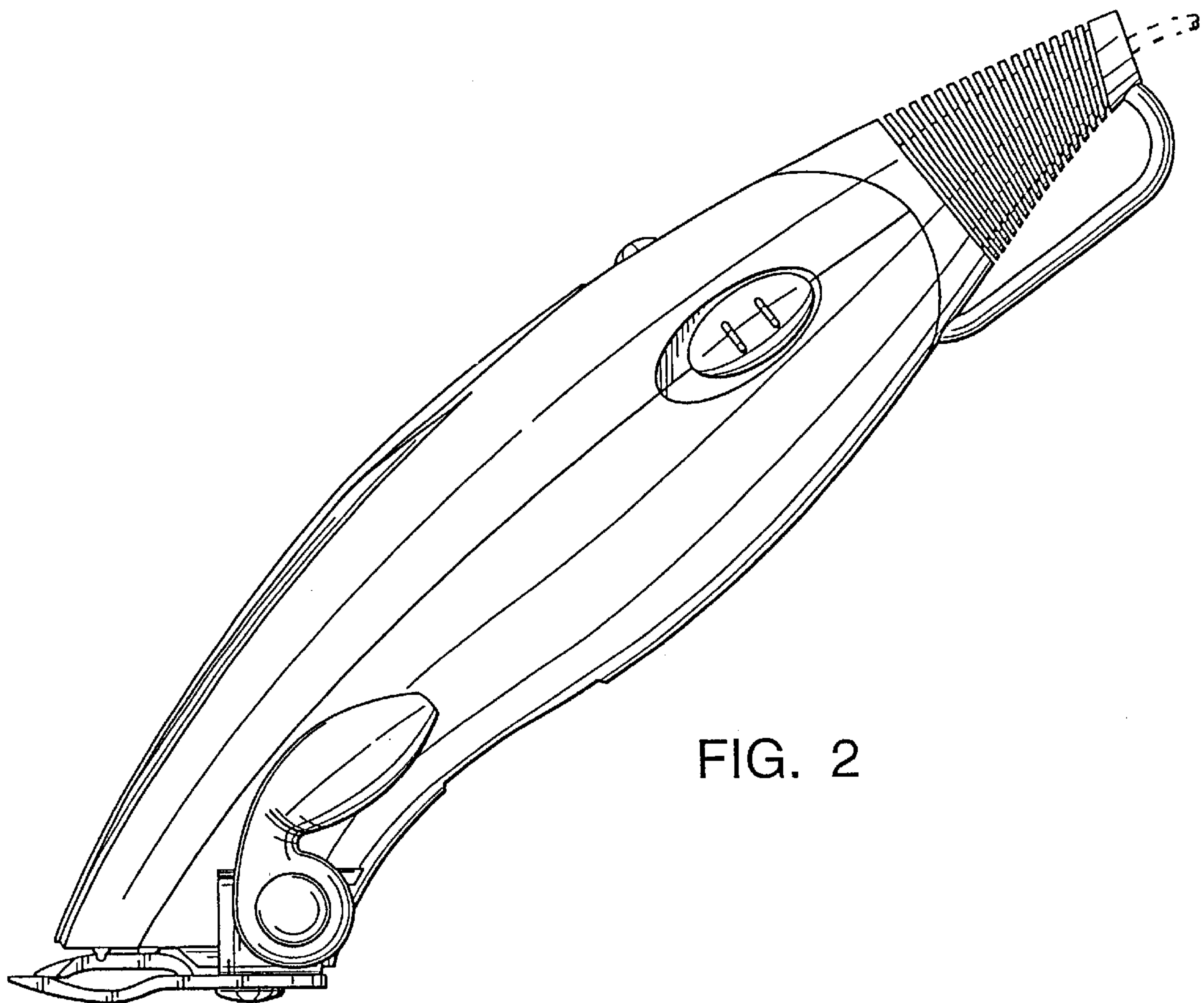

FIG. 2



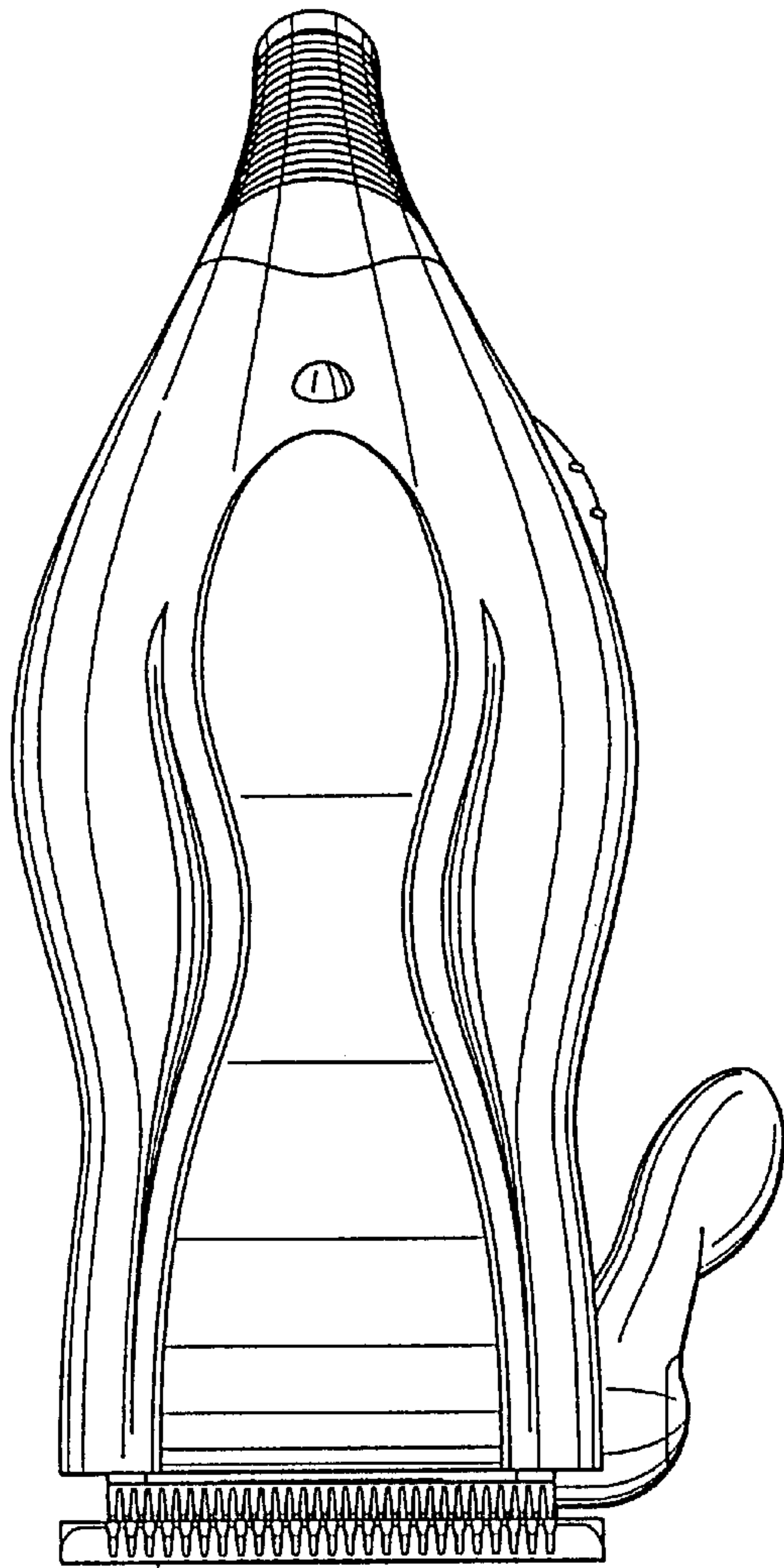

FIG. 4

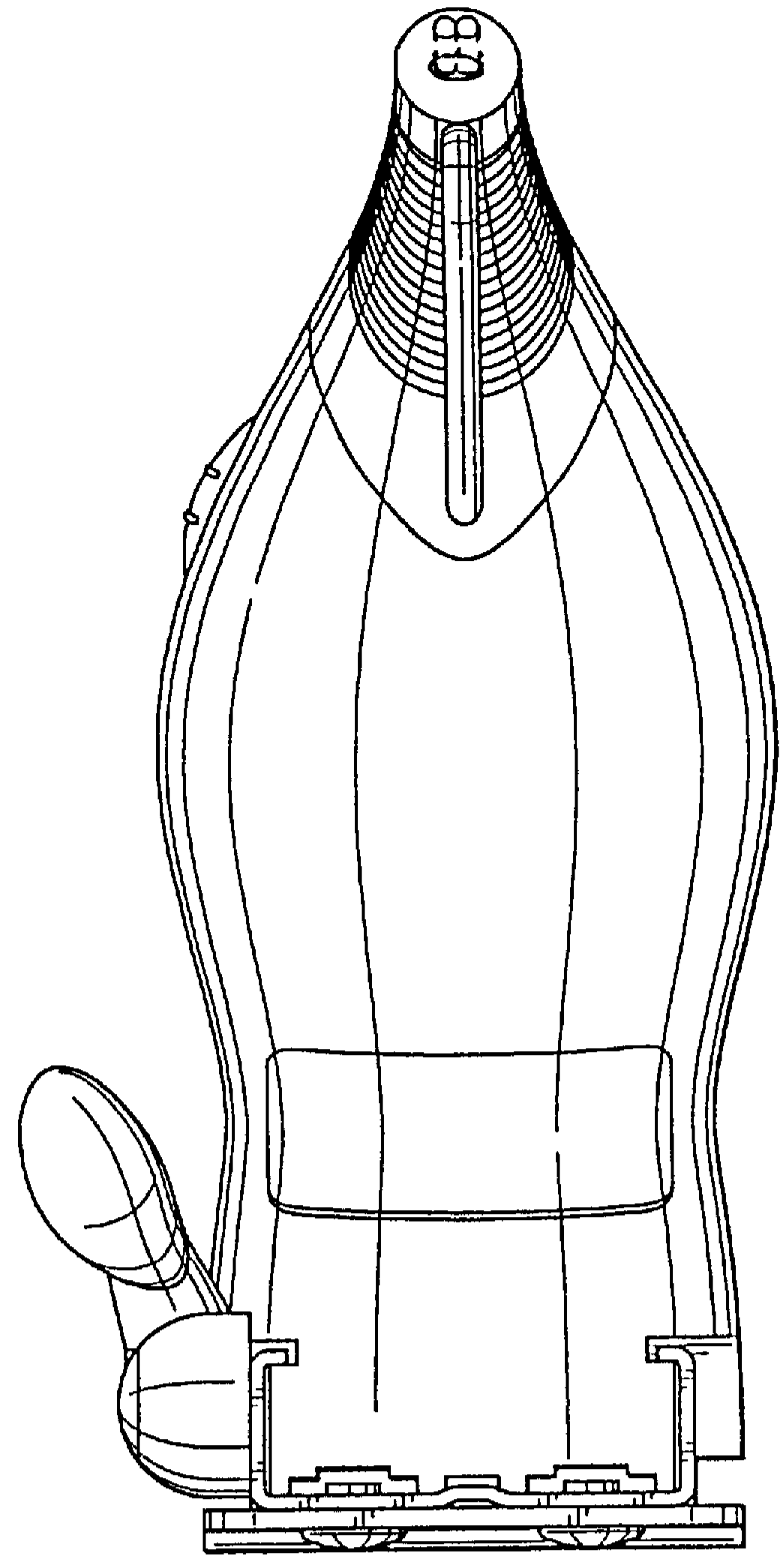

FIG. 5

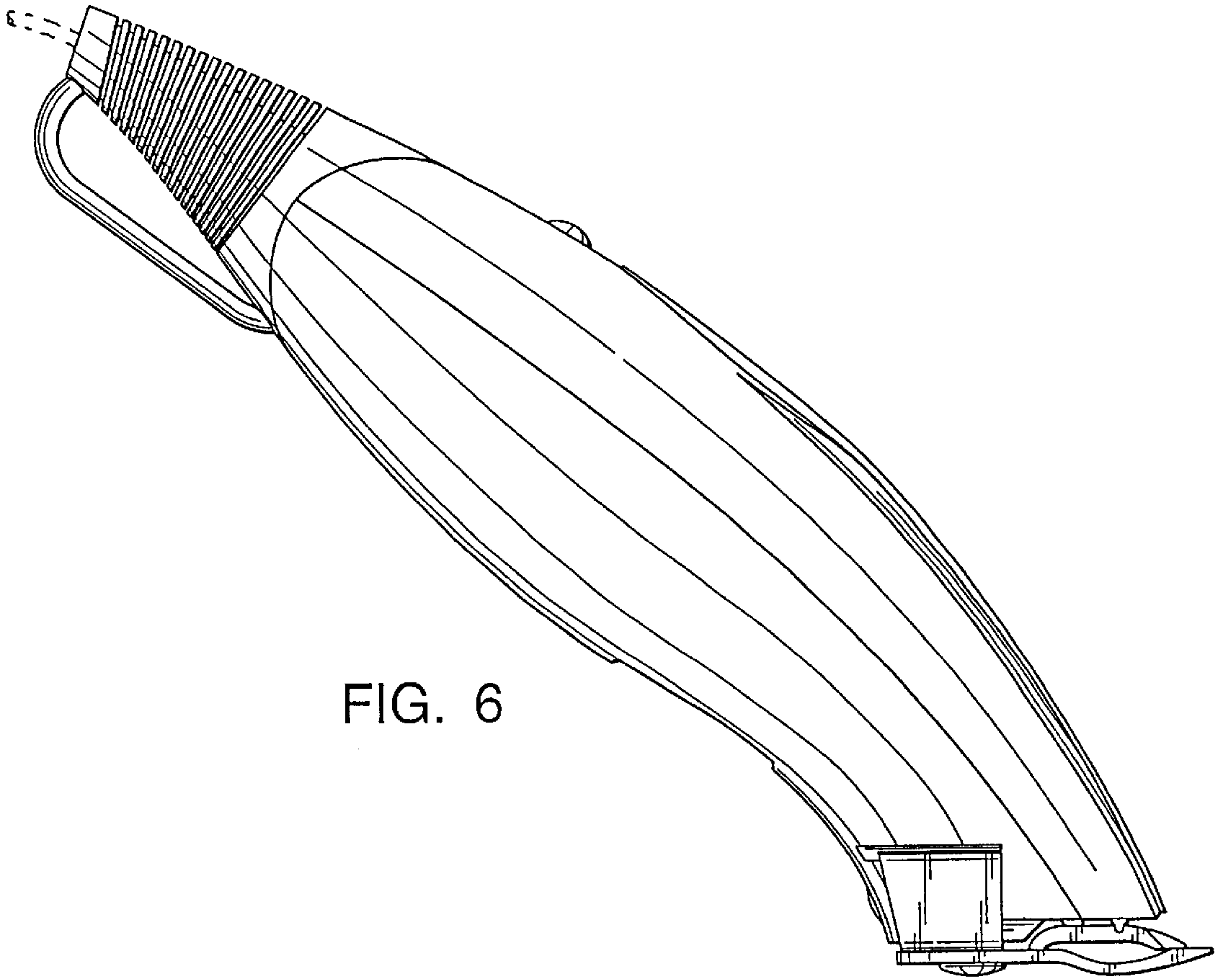

FIG. 6

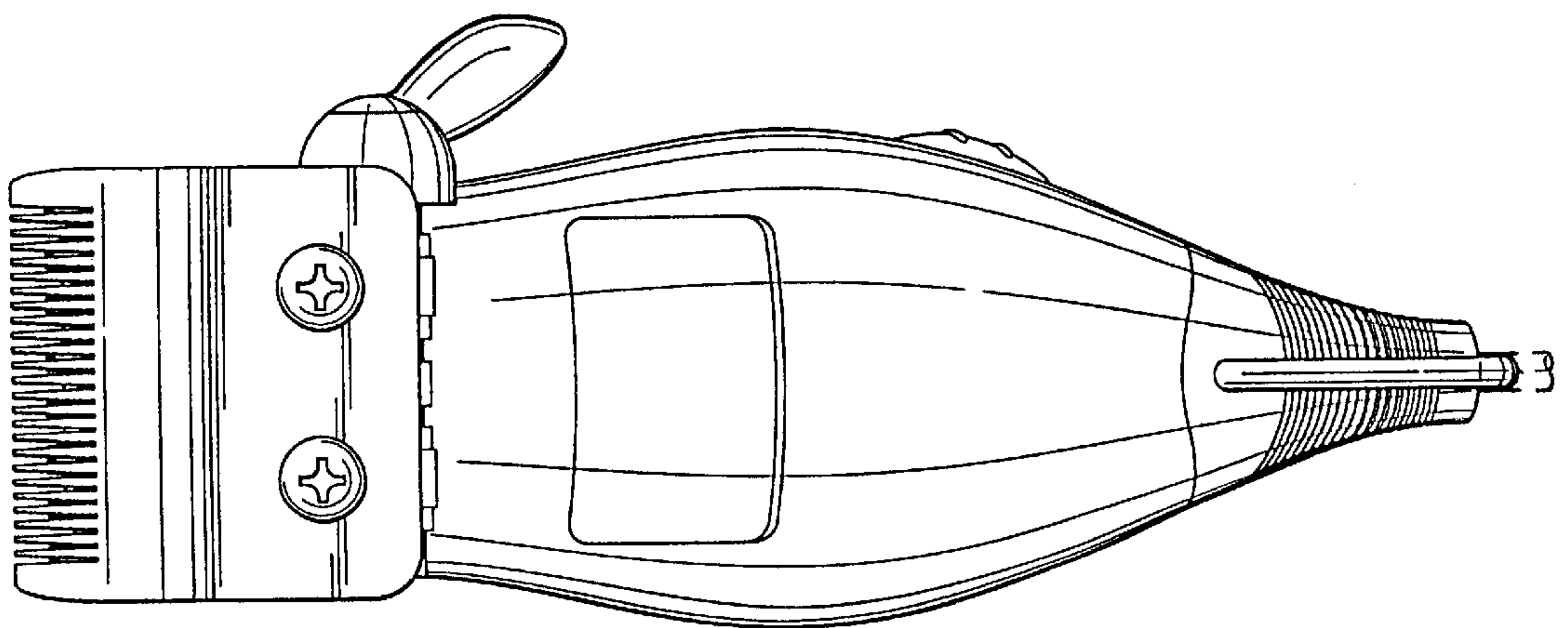

FIG. 7