



US00D455041S

(12) **United States Design Patent**
Smith

(10) **Patent No.:** **US D455,041 S**

(45) **Date of Patent:** **** Apr. 2, 2002**

(54) **CONTACT GRILL**

(75) **Inventor:** **Michael E. Smith**, Glen Allen, VA (US)

(73) **Assignee:** **Hamilton Beach/Proctor-Silex, Inc.**, Glen Allen, VA (US)

(**) **Term:** **14 Years**

(21) **Appl. No.:** **29/139,992**

(22) **Filed:** **Apr. 10, 2001**

(51) **LOC (7) Cl.** **07-02**

(52) **U.S. Cl.** **D7/362; D7/352**

(58) **Field of Search** D7/323, 352, 362-367, D7/332, 337-338, 402, 409-410, 328-330; 99/372, 374-376, 379-380, 389, 425, 386, 443 C, 329 RT, 450; 219/450.1, 512

(56) **References Cited**

U.S. PATENT DOCUMENTS

D346,304 S	4/1994	Naft et al.	D7/352
D347,548 S	6/1994	Boehm et al.	D7/352
D366,390 S	1/1996	Vitantonio	D7/363
D367,993 S	3/1996	McClellan	D7/352
D367,994 S	3/1996	Bloom et al.	D7/352
5,606,905 A *	3/1997	Boehm et al.	99/375
D379,733 S	6/1997	Liu et al.	D7/337
D383,353 S	9/1997	Piret	D7/352
D384,546 S	10/1997	Lin	D7/352
D389,372 S	1/1998	Saltet	D7/352
D394,584 S	5/1998	Weber	D7/363
D405,312 S	2/1999	Hoare	D7/352

D407,598 S	4/1999	Deni et al.	D7/352
D409,041 S	5/1999	Barker	D7/362
D409,876 S	5/1999	Gruaz	D7/352
D411,937 S	7/1999	Siegler et al.	D7/352
D412,808 S	8/1999	Hinton et al.	D7/362
D413,759 S	9/1999	Carrere	D7/352
D413,760 S	9/1999	Tsai et al.	D7/352
D415,927 S	11/1999	Weber	D7/363
6,062,130 A *	5/2000	Brady	99/332
D427,480 S	7/2000	Brady	D7/354
D435,755 S *	1/2001	Deni	D7/352
D437,727 S *	2/2001	Gruaz	D7/352
D448,238 S *	9/2001	Schmidt	D7/362

* cited by examiner

Primary Examiner—Ruth McInroy

(74) *Attorney, Agent, or Firm*—Darby & Darby

(57) **CLAIM**

The ornamental design for a contact grill, as shown and described.

DESCRIPTION

FIG. 1 is a perspective view of a contact grill showing my new design;
FIG. 2 is a front view;
FIG. 3 is a right elevational view;
FIG. 4 is a rear elevational view;
FIG. 5 is a left elevational view;
FIG. 6 is a top plan view;
FIG. 7 is a bottom plan view; and,
FIG. 8 is a top perspective view showing the open contact grill.

1 Claim, 4 Drawing Sheets

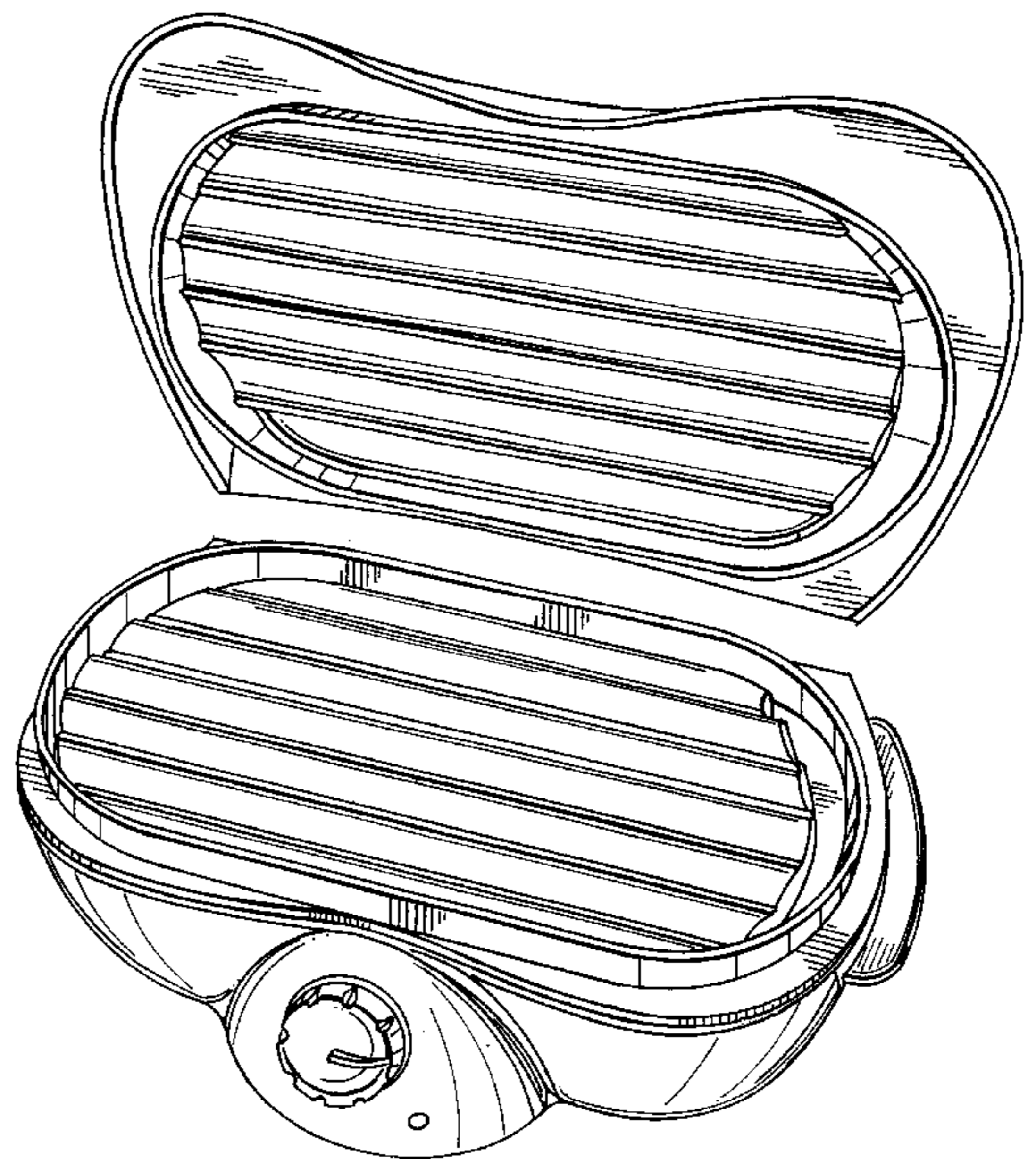
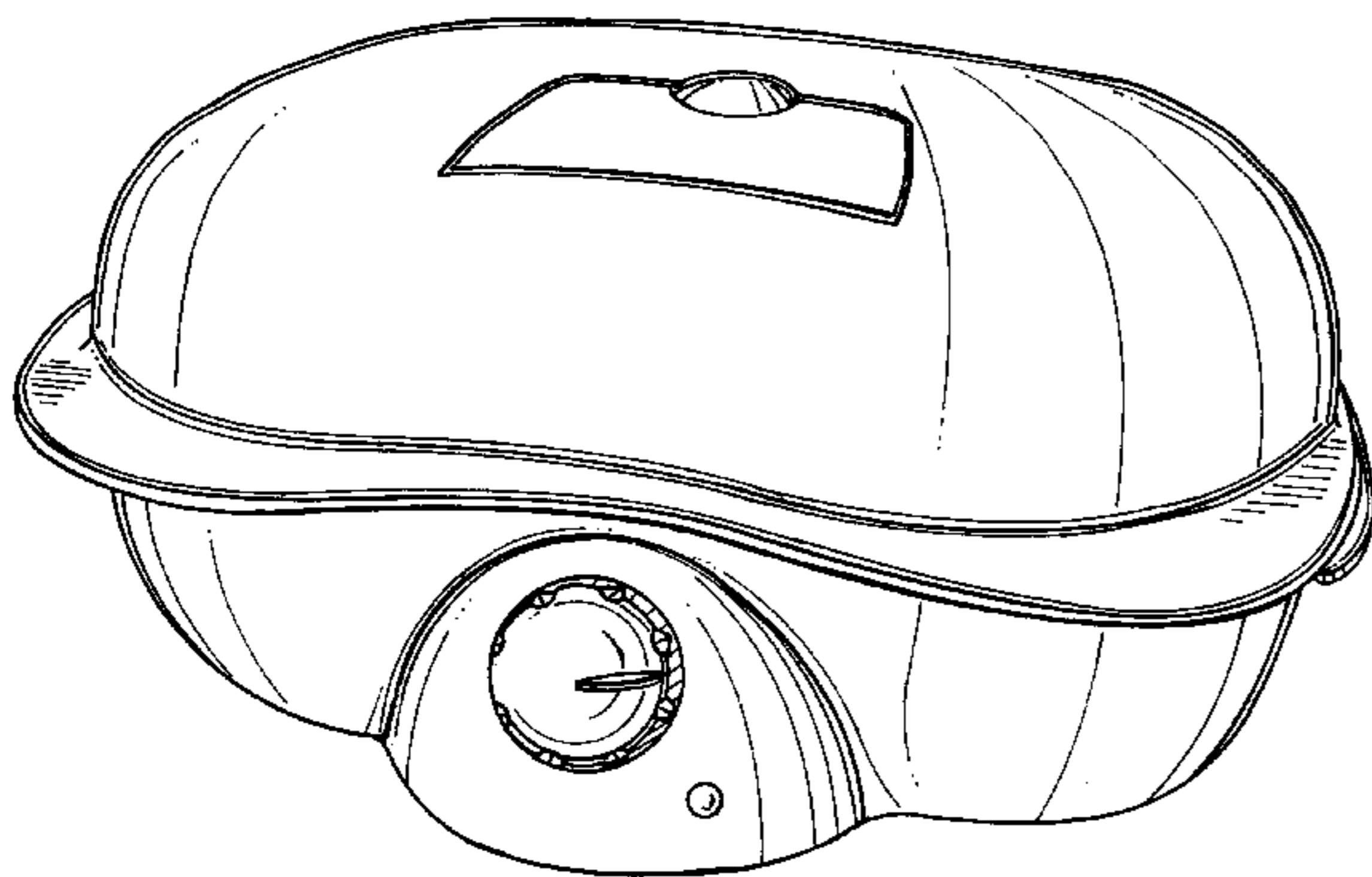

FIG. 1

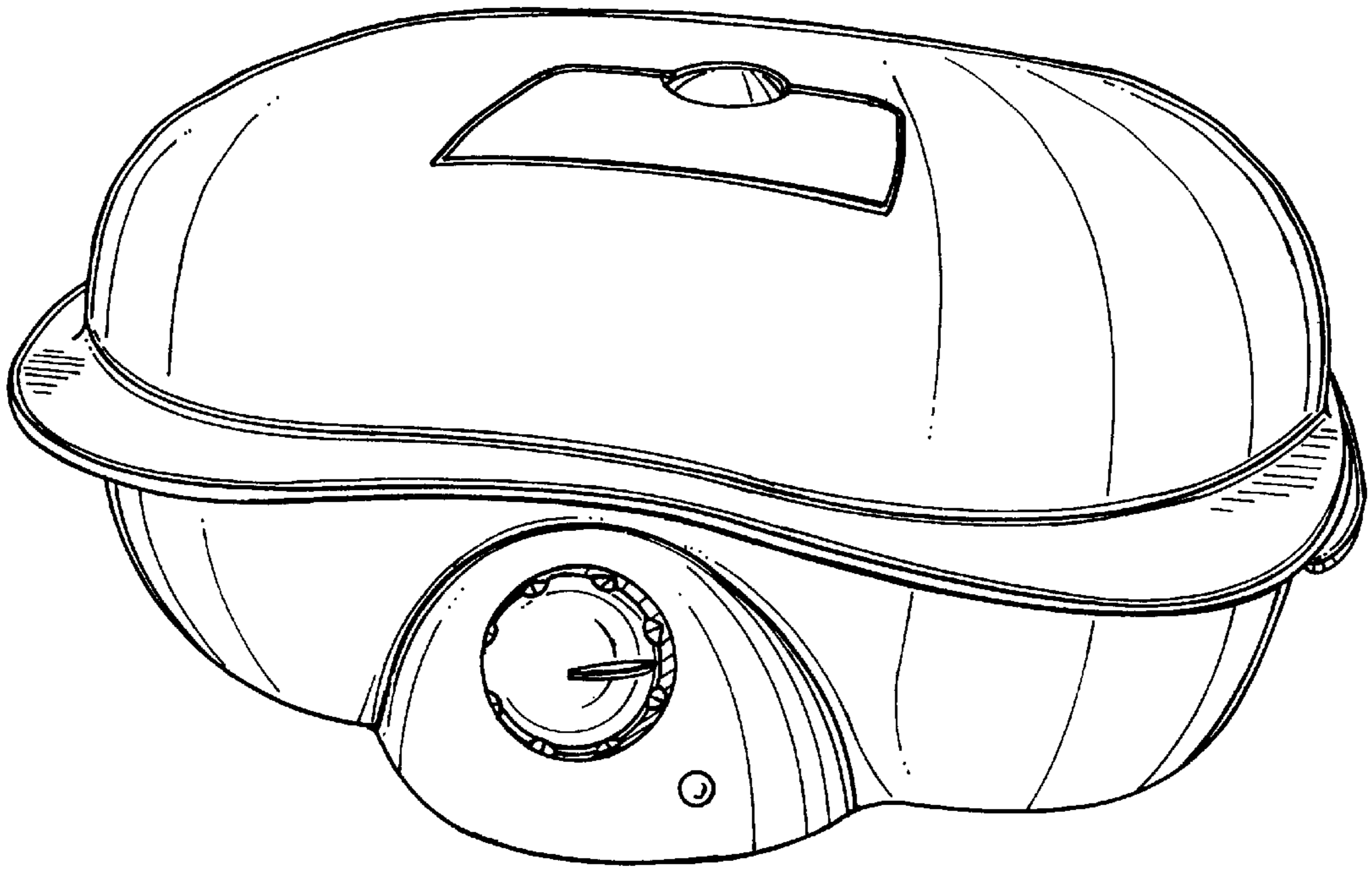
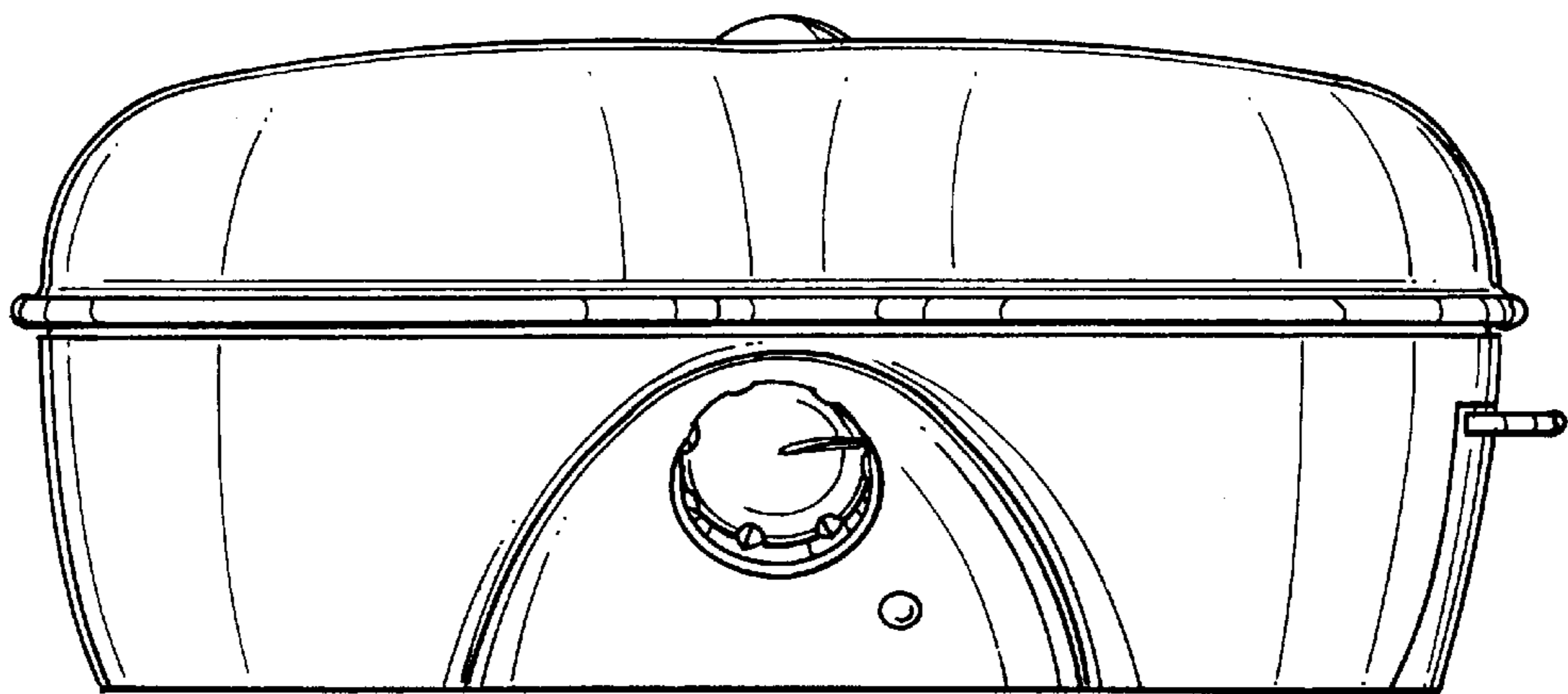

FIG. 2



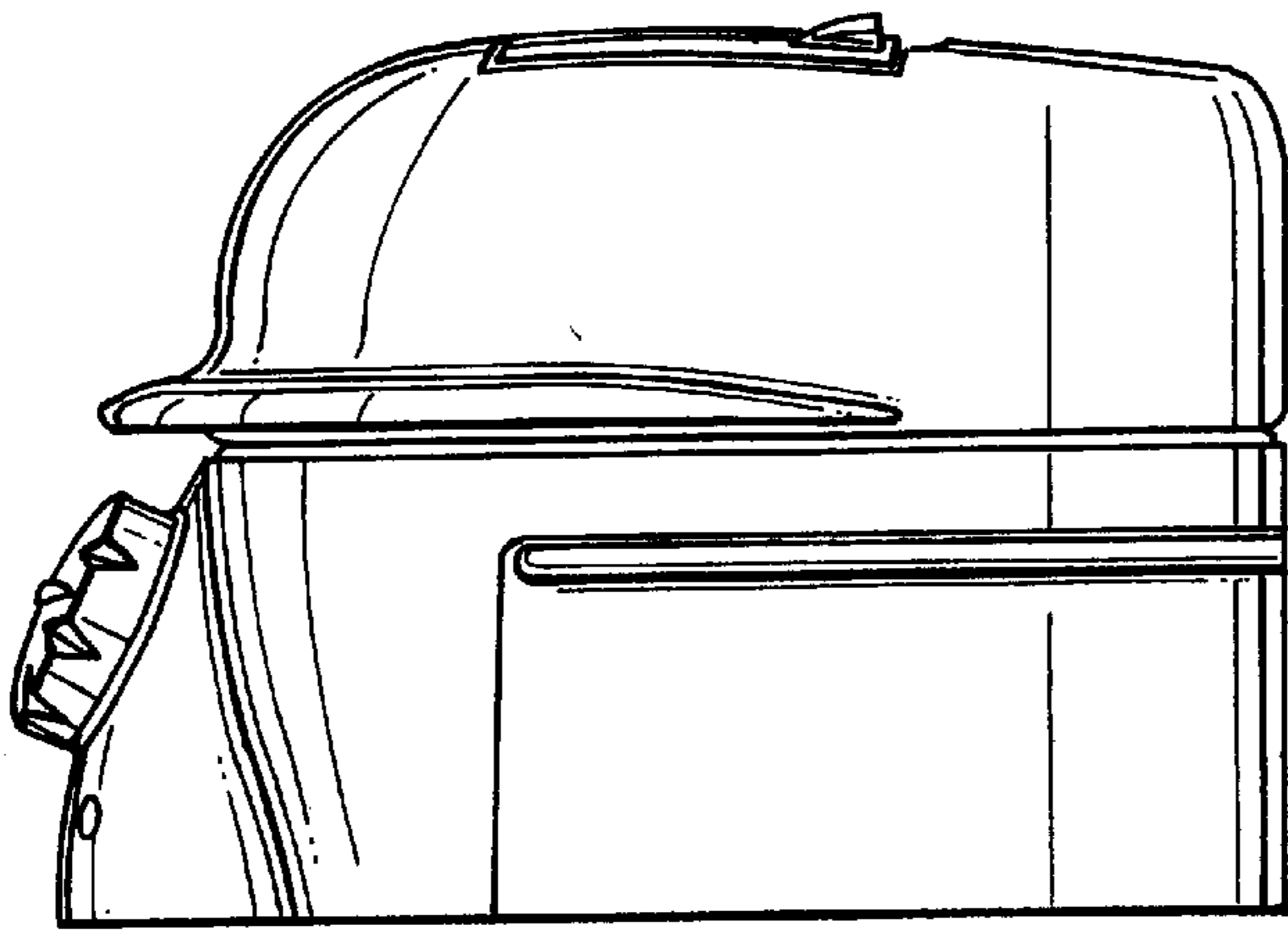

FIG. 3

FIG. 4

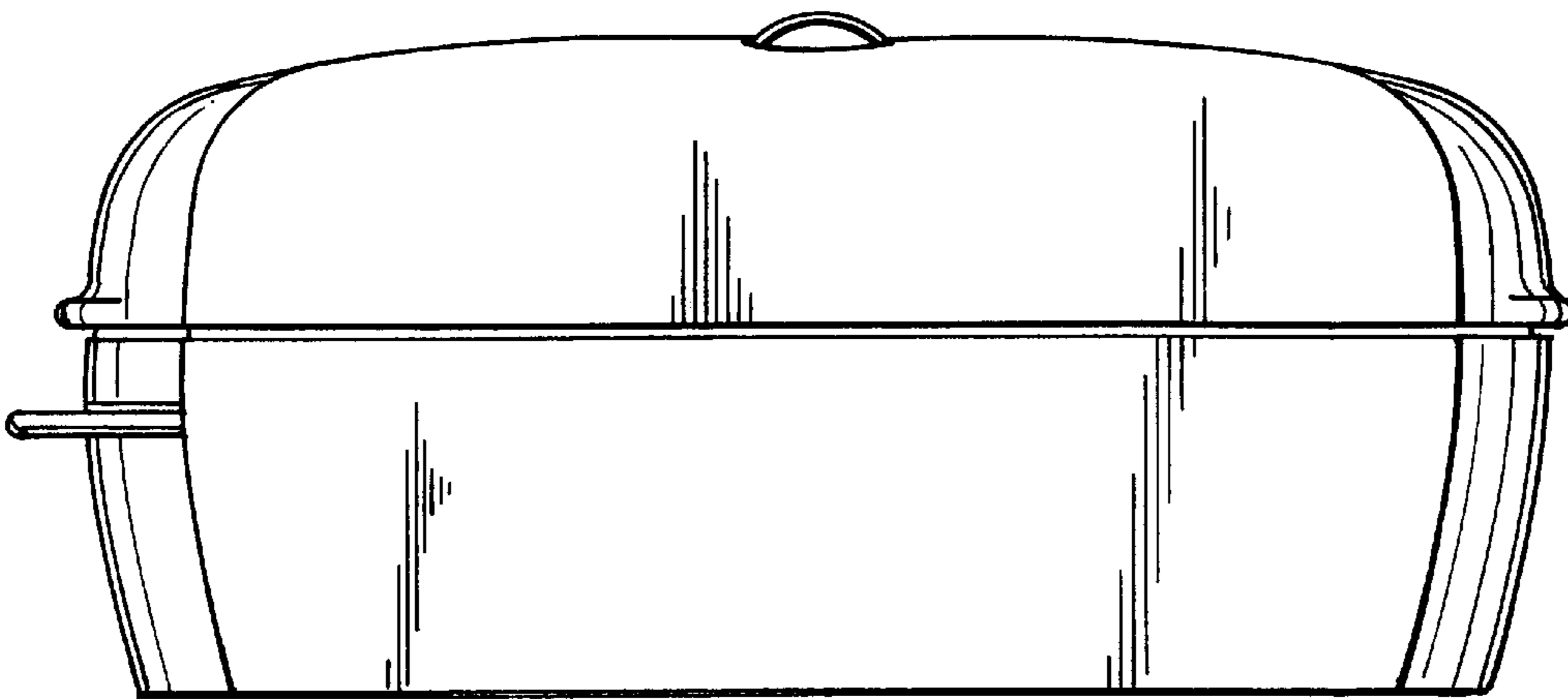

FIG. 5

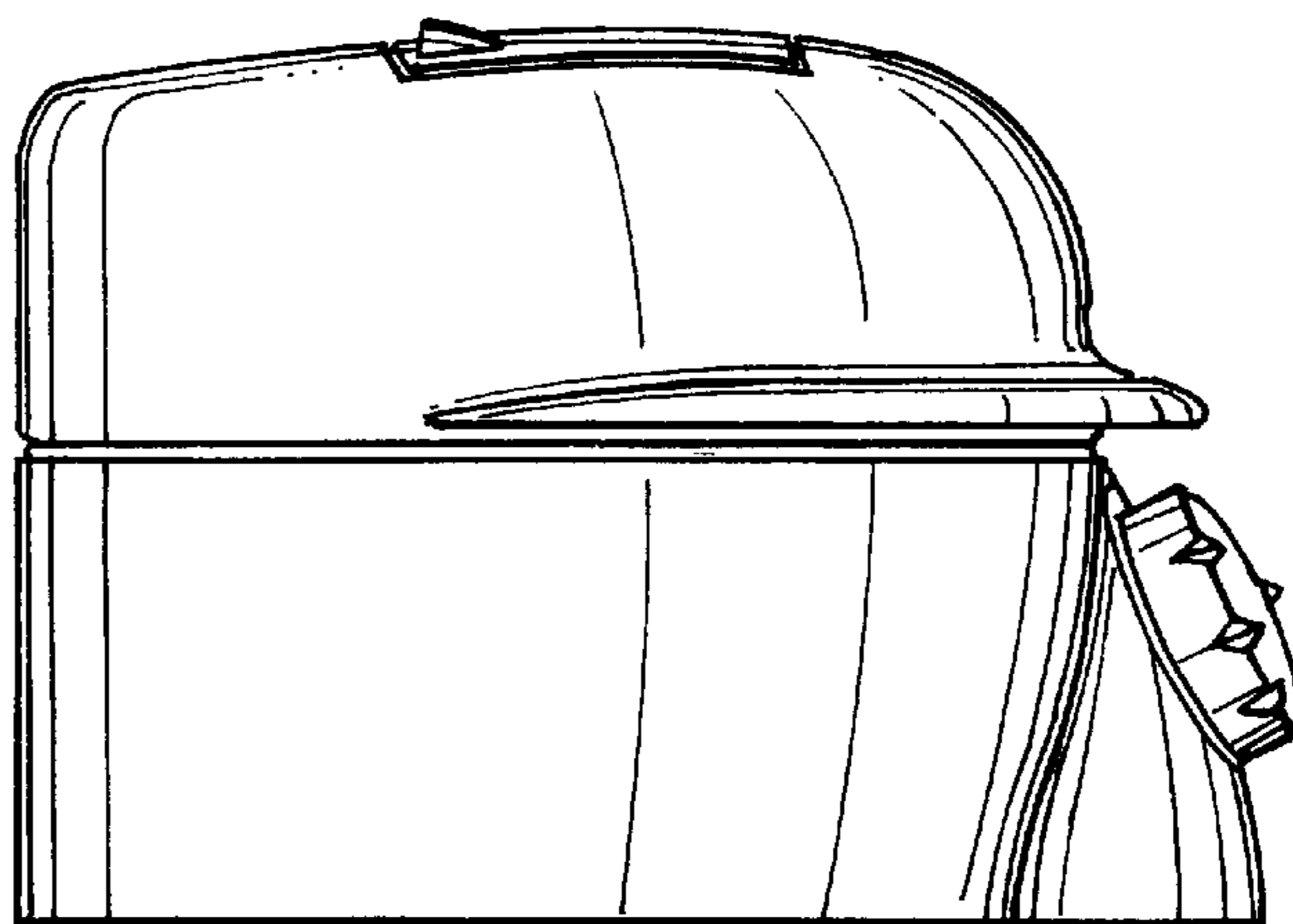

FIG. 6

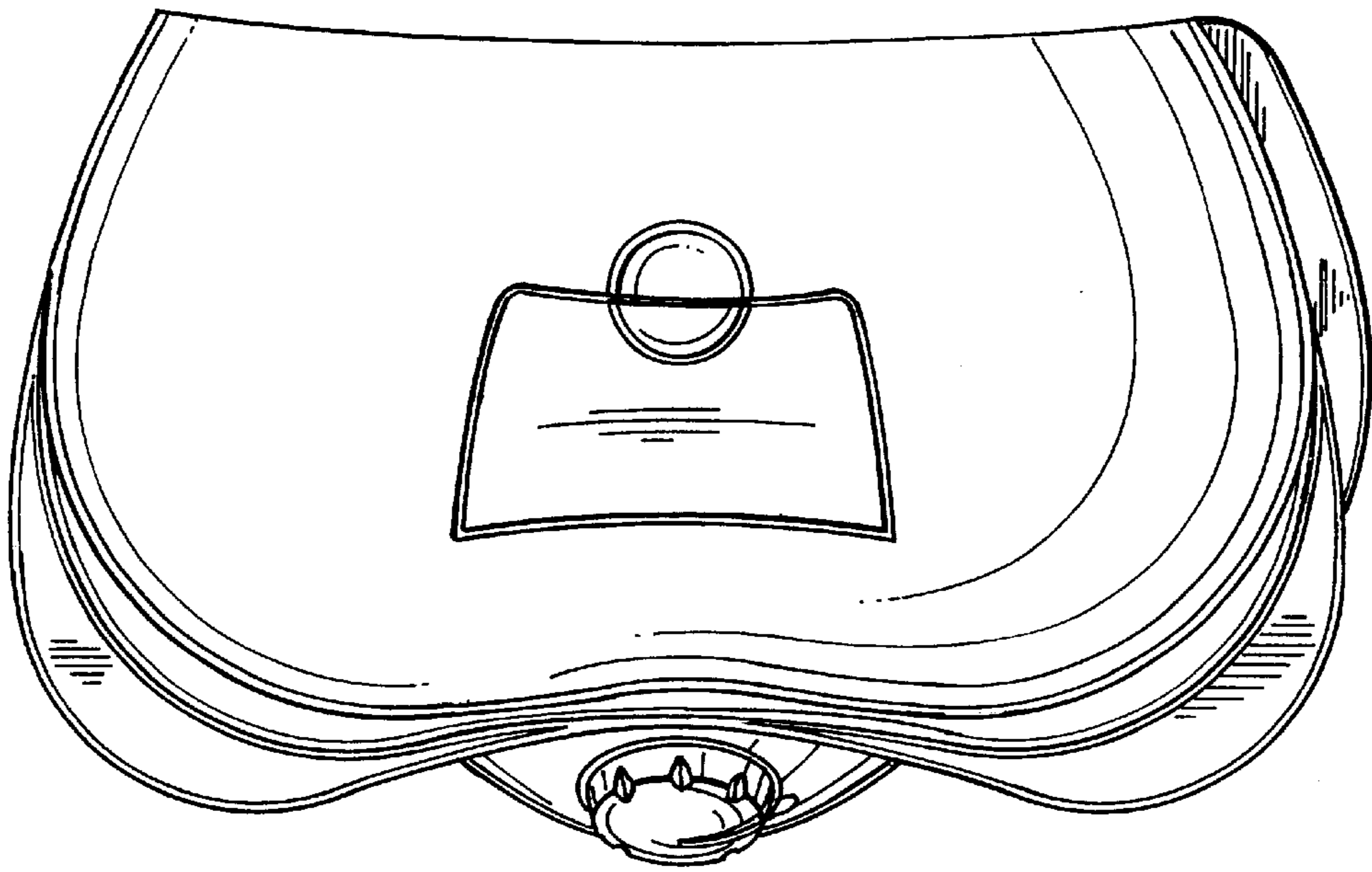

FIG. 7

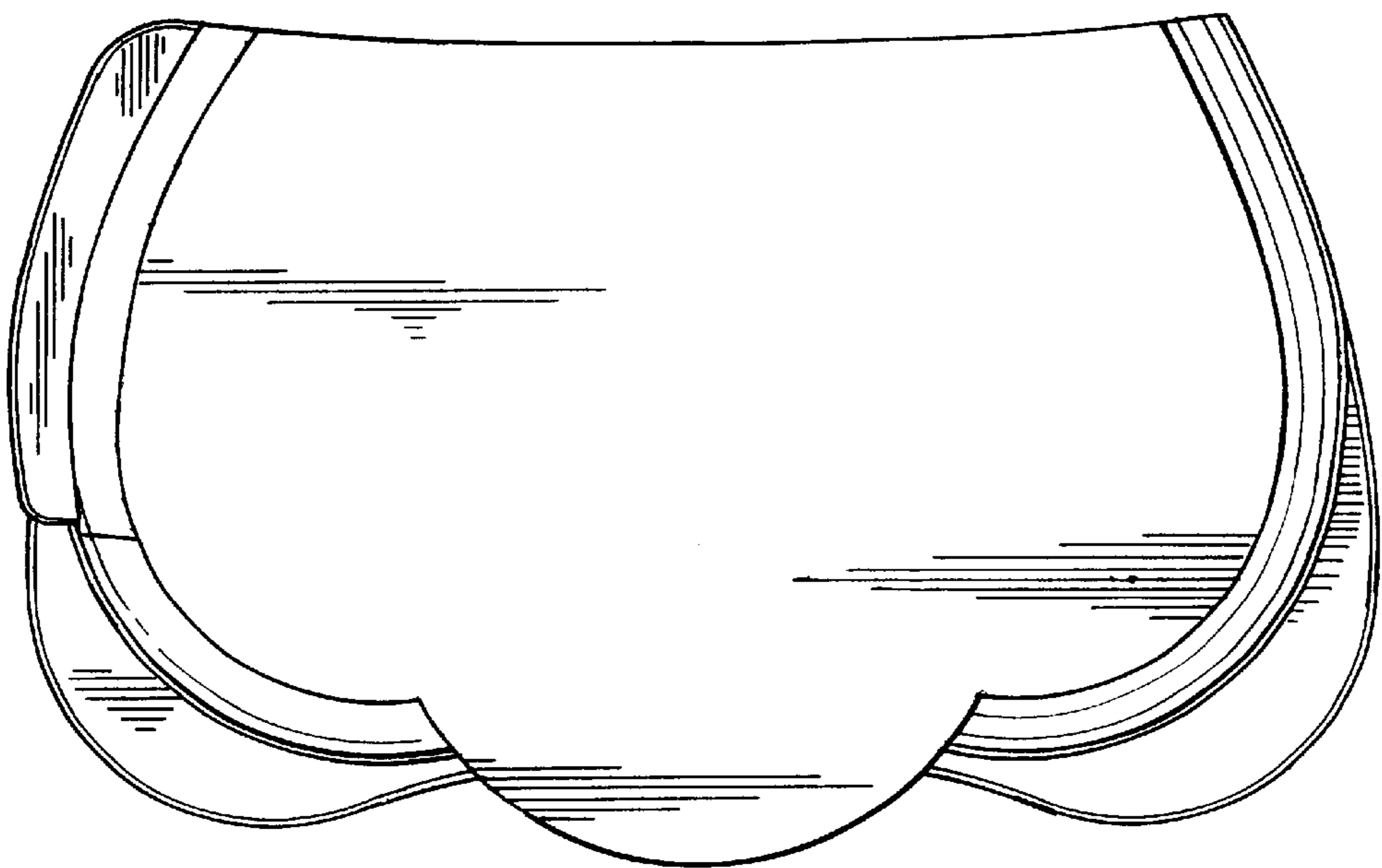

FIG. 8

