



US00D454997S

(12) **United States Design Patent**
Matre et al.

(10) **Patent No.:** **US D454,997 S**
(45) **Date of Patent:** **** Mar. 26, 2002**

(54) **HAND TRUCK BODY**

(75) Inventors: **Daniel A. Matre**, Wauwatosa; **Terrence K. Mahon**, Whitefish Bay; **Roland E. C. Schwarz**, Cudahy, all of WI (US)

(73) Assignee: **Matre Design, Inc.**, Milwaukee, WI (US)

(**) Term: **14 Years**

(21) Appl. No.: **29/142,621**

(22) Filed: **May 30, 2001**

(51) **LOC (7) Cl.** **12-02**

(52) **U.S. Cl.** **D34/27; D34/24**

(58) **Field of Search** D34/12-27; 280/47.19, 280/47.17, 47.24, 47.27, 47.28, 652, 659

(56) **References Cited**

U.S. PATENT DOCUMENTS

1,099,584 A	6/1914	Wedge
3,079,168 A	2/1963	Monroe et al.
3,863,946 A	2/1975	Dotson
4,136,889 A	1/1979	Middleton
4,452,468 A	6/1984	Eads et al.
4,869,526 A	9/1989	Blake
4,946,187 A	8/1990	Chang
5,464,244 A	11/1995	Tsai
5,474,313 A	12/1995	Marquardt
5,549,317 A	8/1996	Dunkle
5,671,933 A	9/1997	Tucker

5,749,588 A	5/1998	Stallbaumer
5,913,527 A	6/1999	Hailston
5,941,543 A	8/1999	Kazmark, Jr.
5,957,472 A	9/1999	Borgatti
5,971,424 A	10/1999	Ingalls
5,984,327 A	11/1999	Hsieh et al.
D449,144 S	* 10/2001	Measom D34/27

* cited by examiner

Primary Examiner—Kay H. Chin

(74) *Attorney, Agent, or Firm*—Boyle, Fredrickson, Newholm, Stein & Gratz, S.C.

(57) **CLAIM**

The ornamental design of a hand truck body, as shown and described.

DESCRIPTION

FIG. 1 is an front perspective view of a hand truck body incorporating our new design;
 FIG. 2 is a rear perspective view thereof;
 FIG. 3 is a front elevation view thereof;
 FIG. 4 is a left side elevation view thereof, the right side elevation view being a mirror image;
 FIG. 5 is a top plan view thereof;
 FIG. 6 is a rear elevation view thereof; and,
 FIG. 7 is a bottom plan view thereof.
 The broken lines are for illustrative purposes only and form no part of the claimed design.

1 Claim, 6 Drawing Sheets

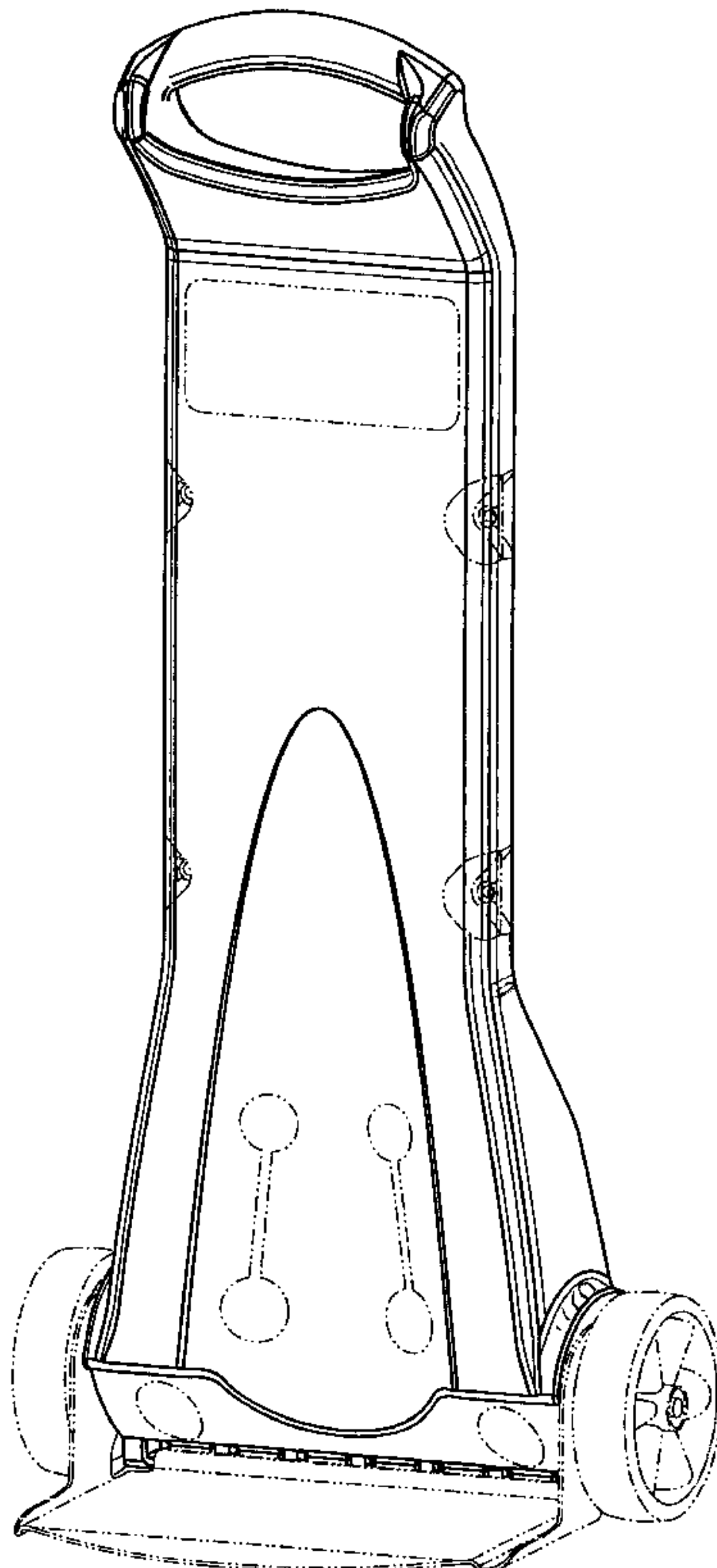

FIG. 1

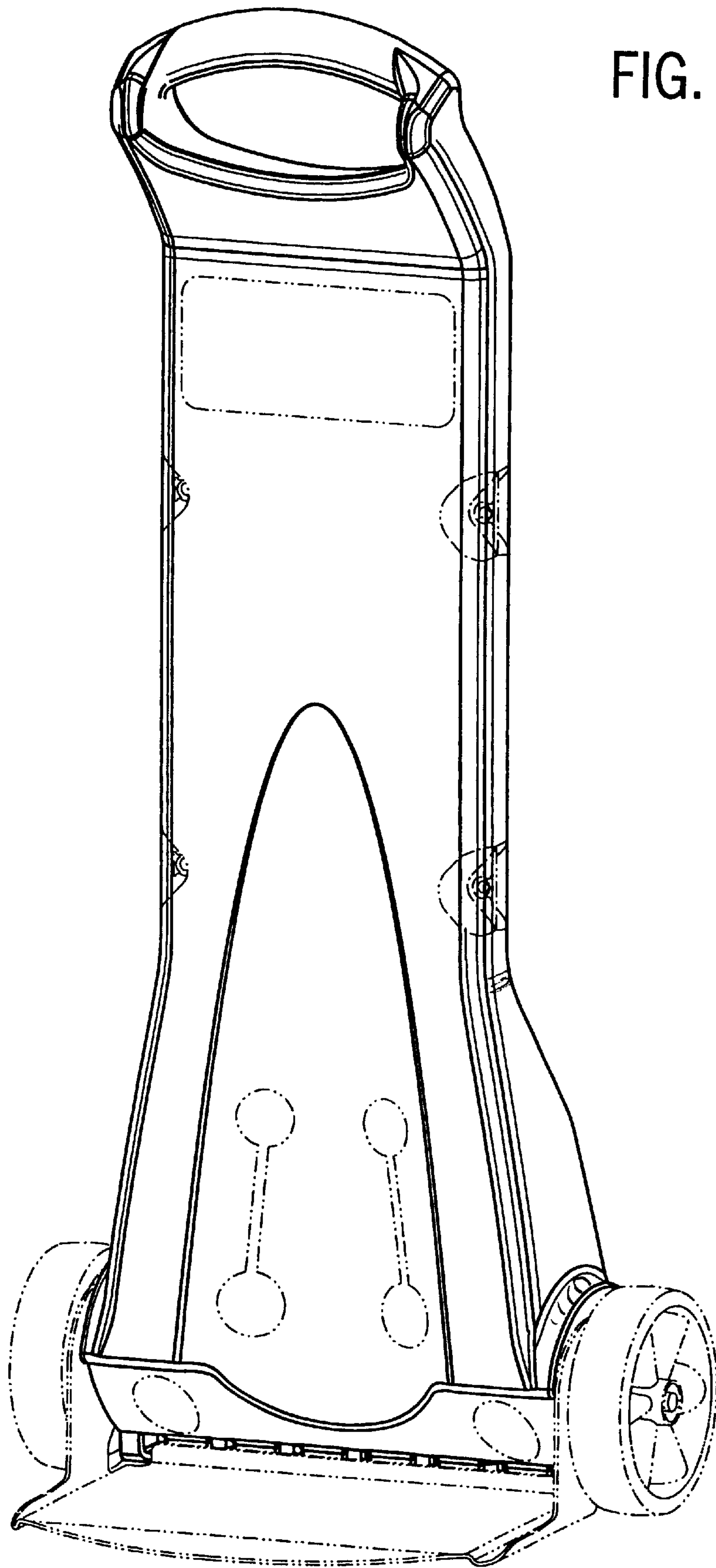

FIG. 2

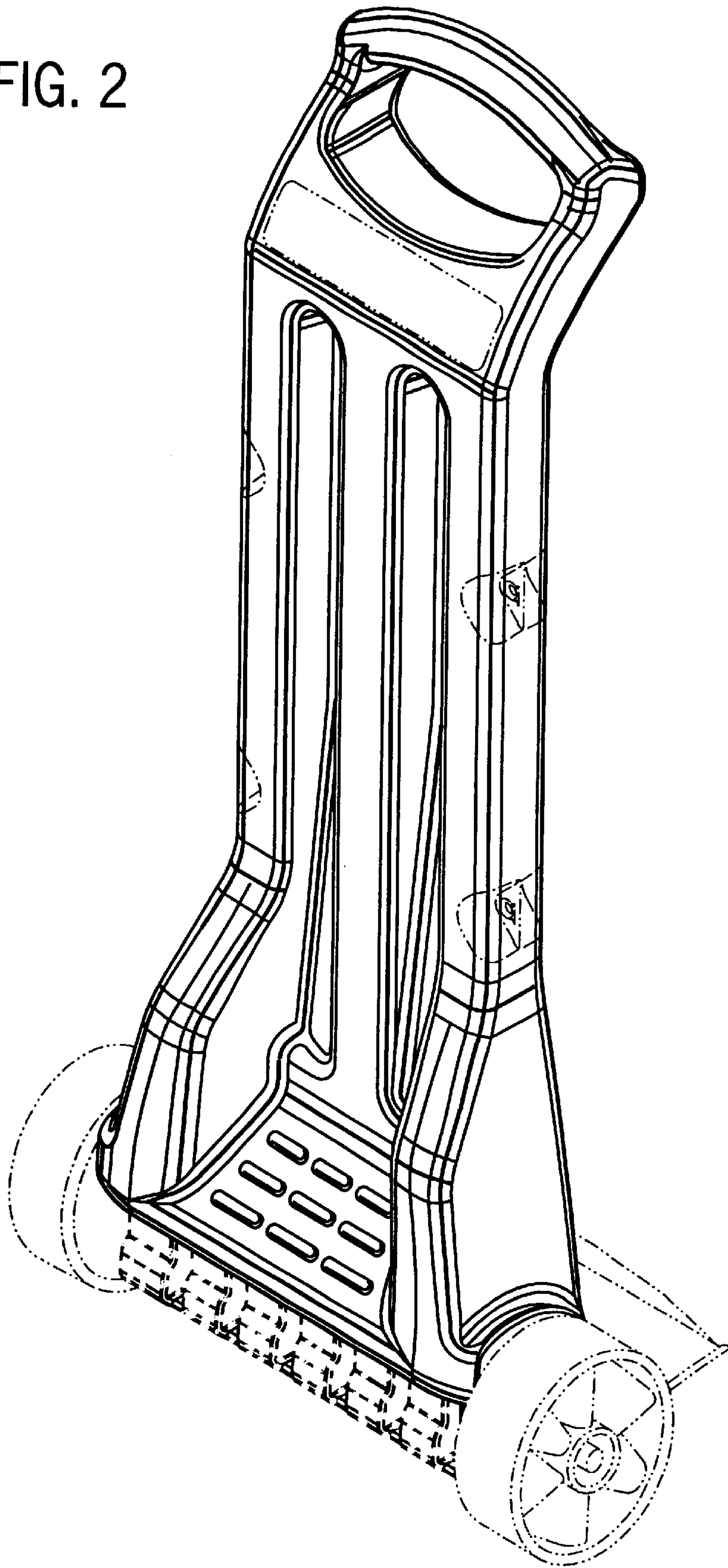

FIG. 3

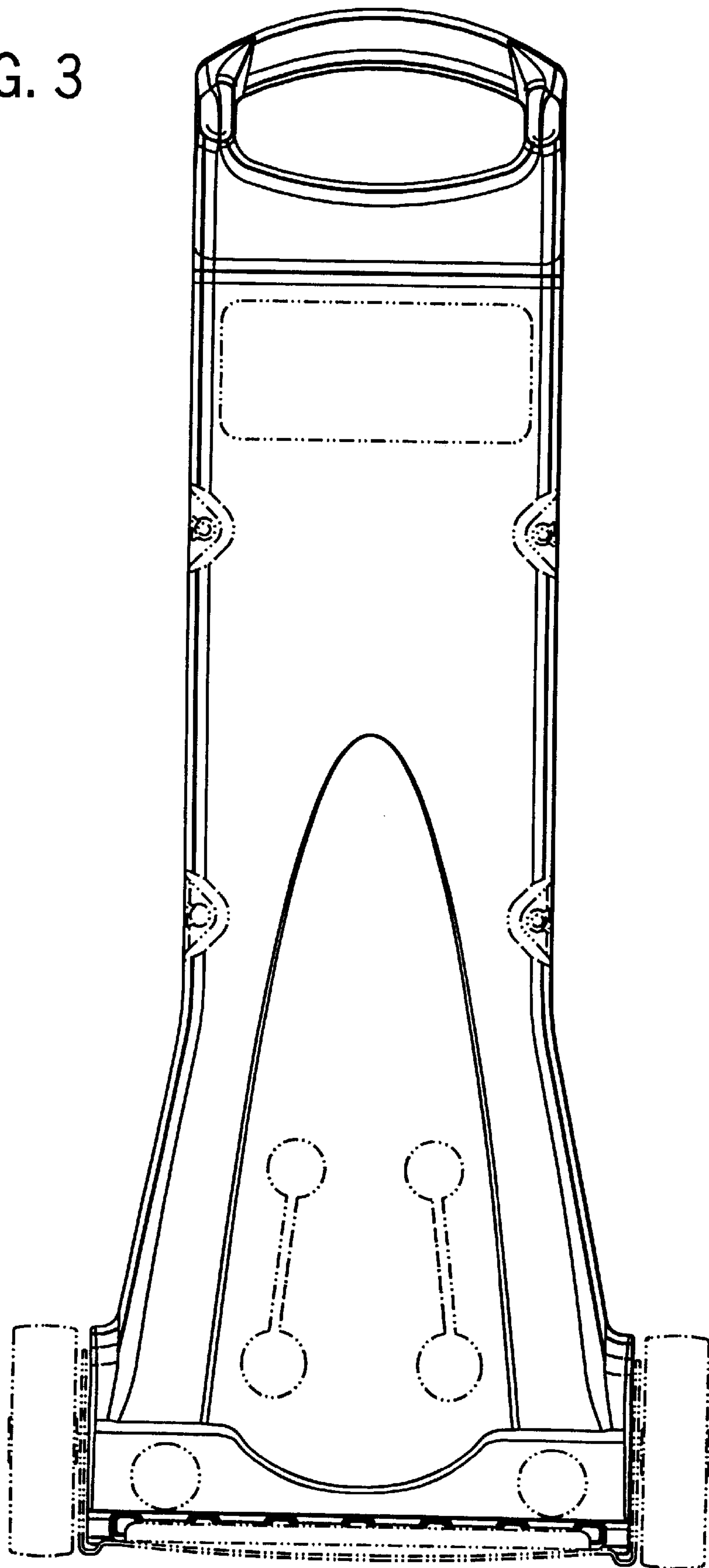
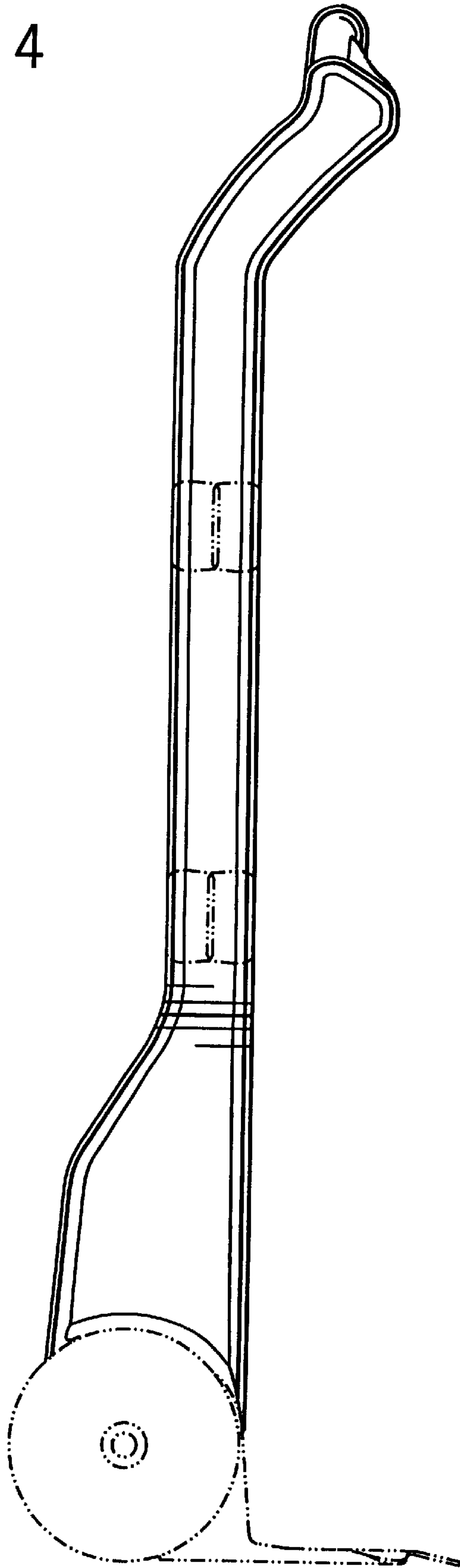

FIG. 4



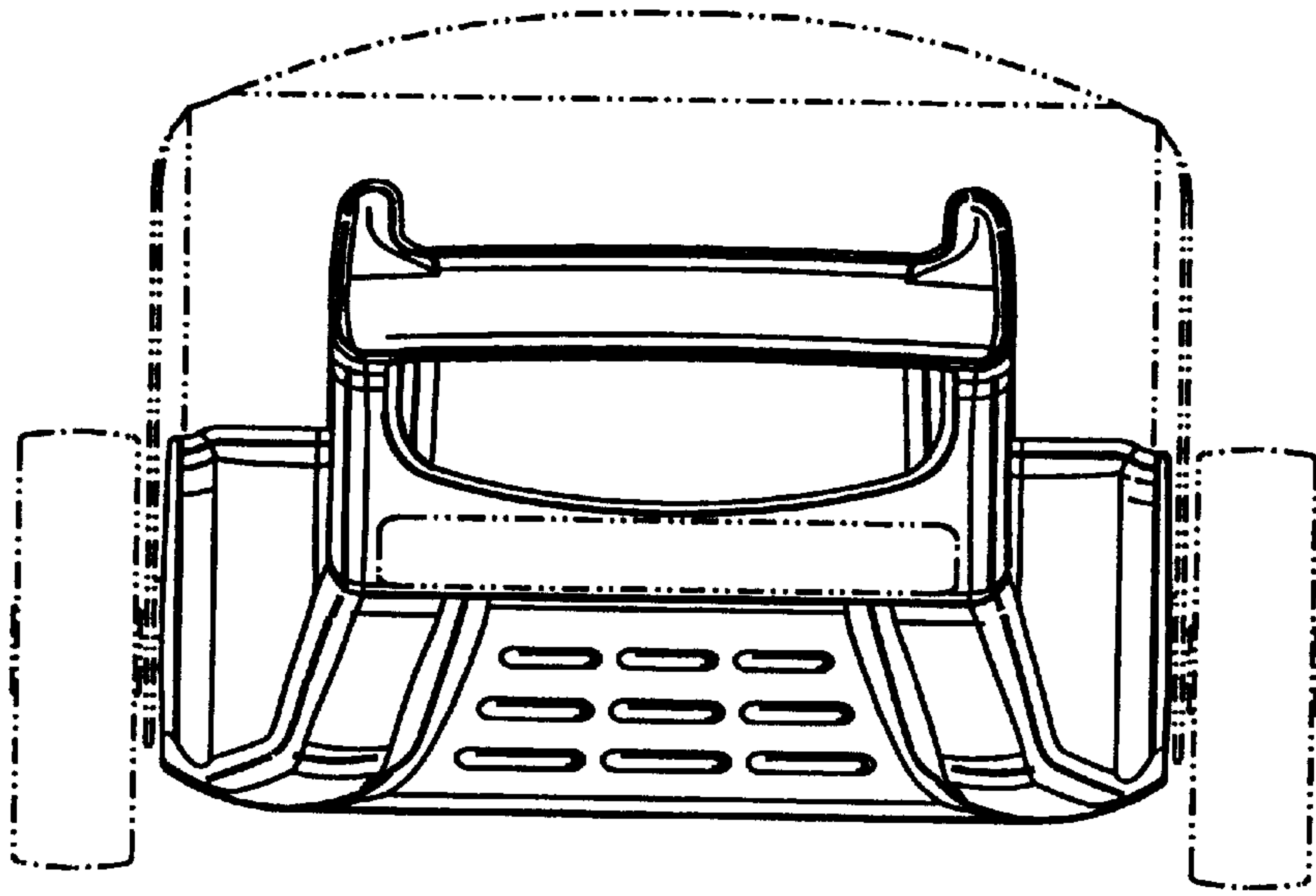

FIG. 5

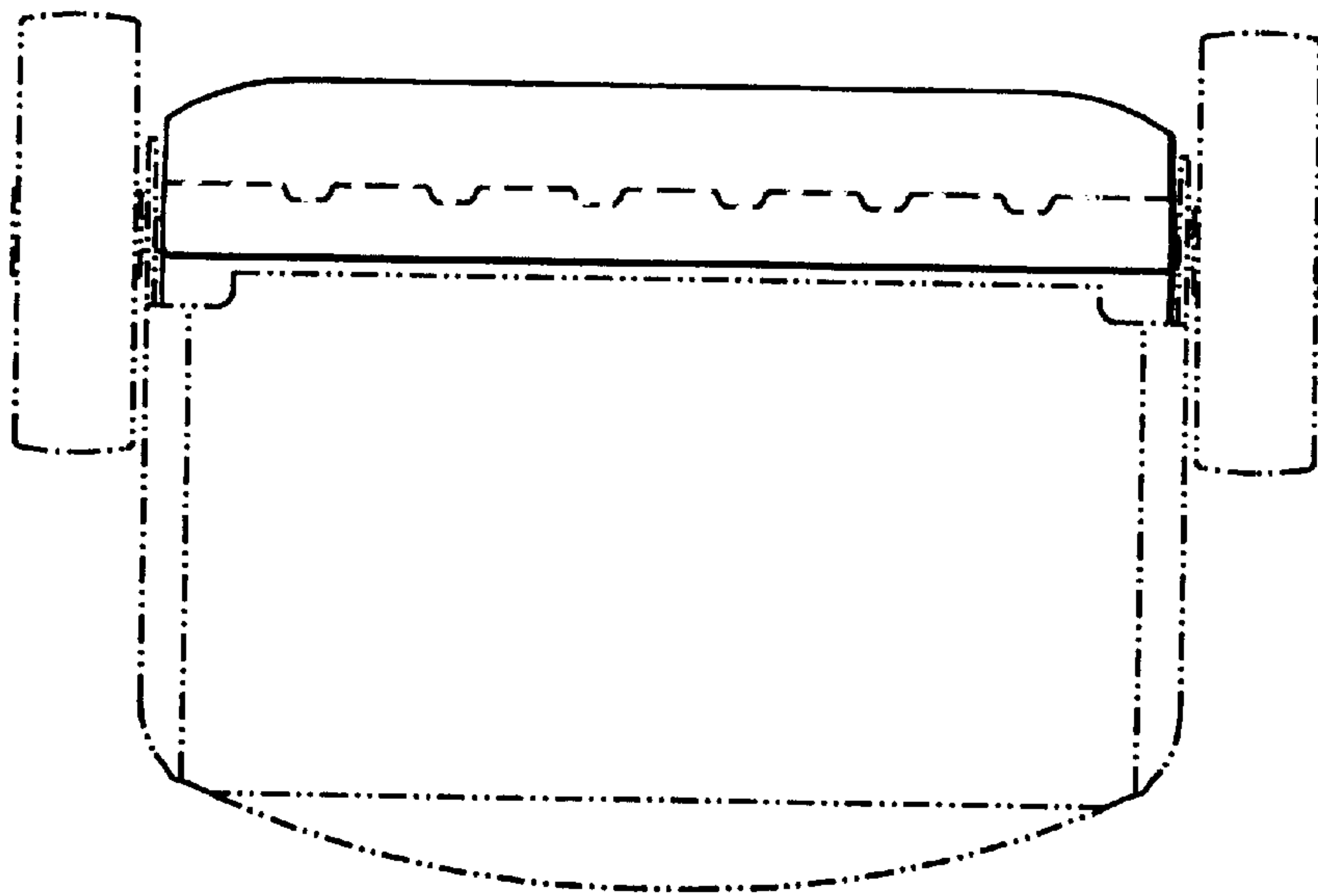

FIG. 7

FIG. 6

