



US00D454977S

(12) **United States Design Patent**  
**McCurrach**

(10) **Patent No.:** **US D454,977 S**

(45) **Date of Patent:** **\*\* Mar. 26, 2002**

(54) **HAIR STYLER**

(75) **Inventor:** **Jamie Craig McCurrach**, Groningen (NL)

(73) **Assignee:** **U.S. Philips Corporation**, New York, NY (US)

(\*\*) **Term:** **14 Years**

(21) **Appl. No.:** **29/146,613**

(22) **Filed:** **Aug. 13, 2001**

(30) **Foreign Application Priority Data**

Feb. 20, 2001 (XH) ..... DMA/005 195

(51) **LOC (7) Cl.** ..... **28-03**

(52) **U.S. Cl.** ..... **D28/35**

(58) **Field of Search** ..... D28/10, 13, 15, D28/35; 132/212, 223-232, 263, 265, 269, 271; 219/222, 225; 34/96-98; 392/380, 383-385

(56) **References Cited**

**U.S. PATENT DOCUMENTS**

- D239,663 S \* 4/1976 Long et al ..... D28/12
- D245,124 S \* 7/1977 Wolff ..... D28/35
- D256,282 S \* 8/1980 Haase ..... D28/13
- D258,015 S \* 1/1981 Lam ..... D28/35
- D270,954 S \* 10/1983 Mizobata et al. .... D28/35

- 4,936,027 A \* 6/1990 Tsuji ..... 34/90
- D418,249 S \* 12/1999 Elkerbout ..... D28/10
- 6,119,702 A \* 9/2000 Habibi ..... 132/224
- D439,701 S \* 3/2001 Engelen ..... D28/13

**FOREIGN PATENT DOCUMENTS**

JP 6-38823 A \* 2/1994 ..... 219/222

**OTHER PUBLICATIONS**

Hong Kong Enterprise Oct. 1997, p. 51: hair implements indicated by arrows.\*

\* cited by examiner

*Primary Examiner*—Ted Shooman

*Assistant Examiner*—C Tuttle

(74) *Attorney, Agent, or Firm*—Ernestine C. Bartlett

(57) **CLAIM**

The ornamental design for a hair styler, as shown.

**DESCRIPTION**

FIG. 1 is a perspective view showing my design; FIG. 2 is a front elevational view thereof; FIG. 3 is a rear elevational view thereof; FIG. 4 is a right side elevational view thereof; FIG. 5 is a left side elevational view thereof; FIG. 6 is a top plan view thereof; and, FIG. 7 is a bottom plan view thereof.

**1 Claim, 6 Drawing Sheets**

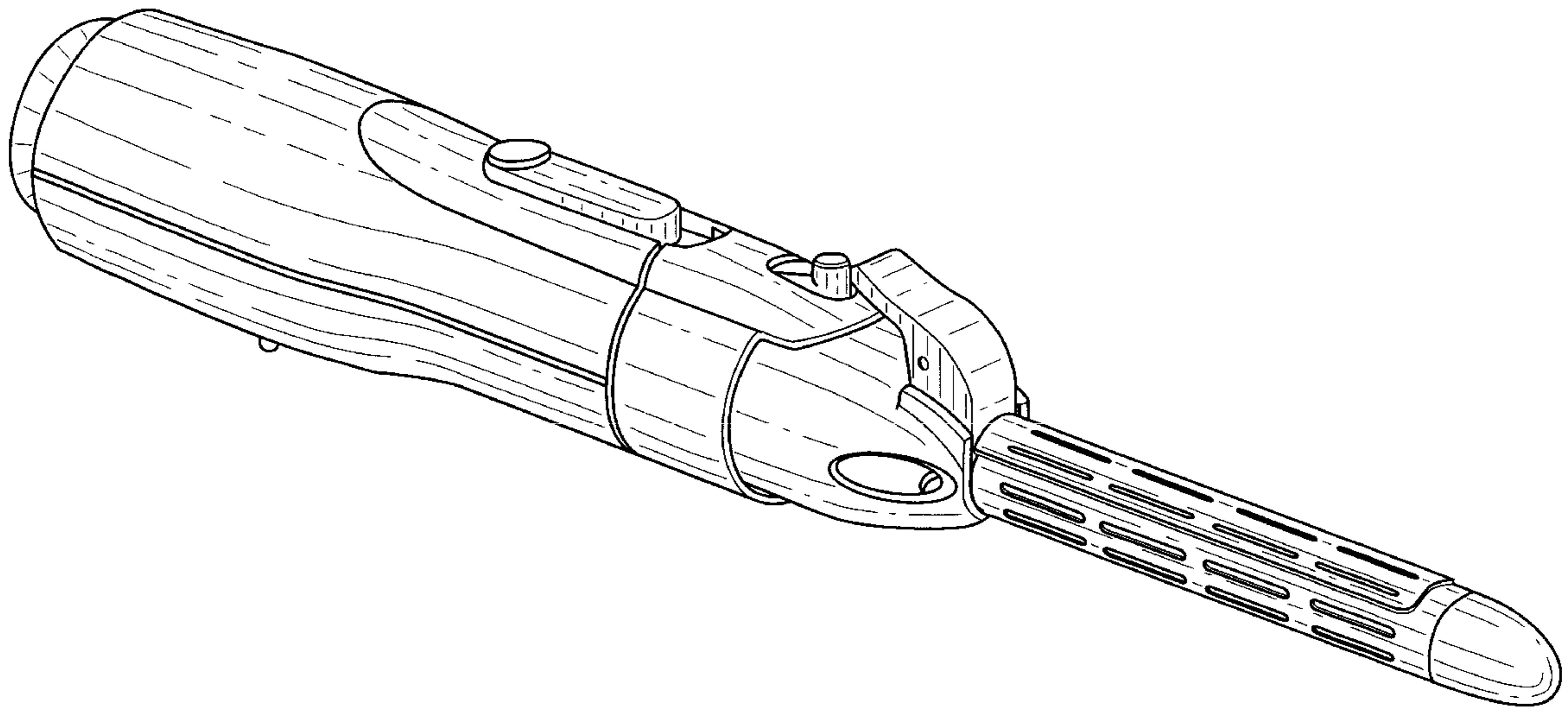

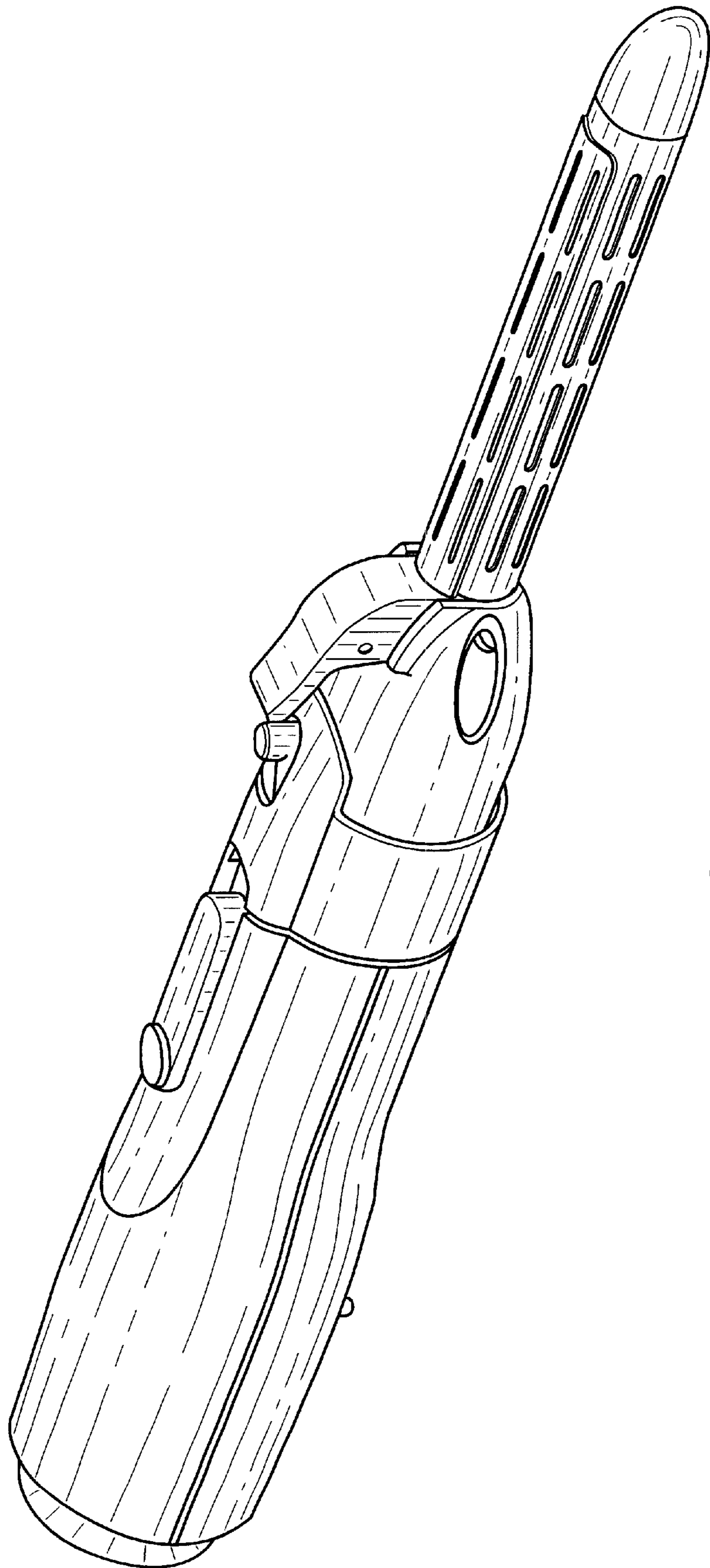

FIG. 1

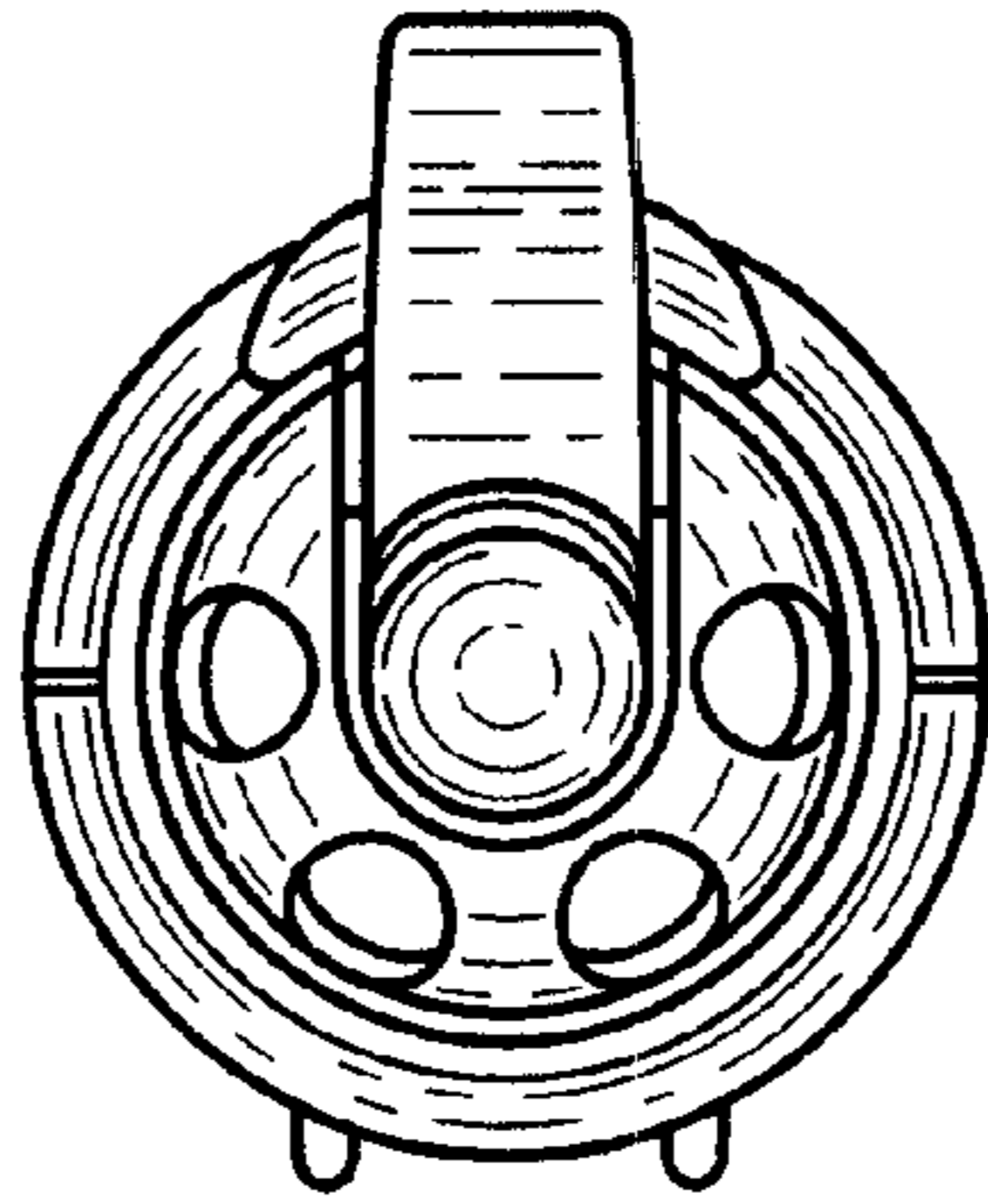

FIG. 2

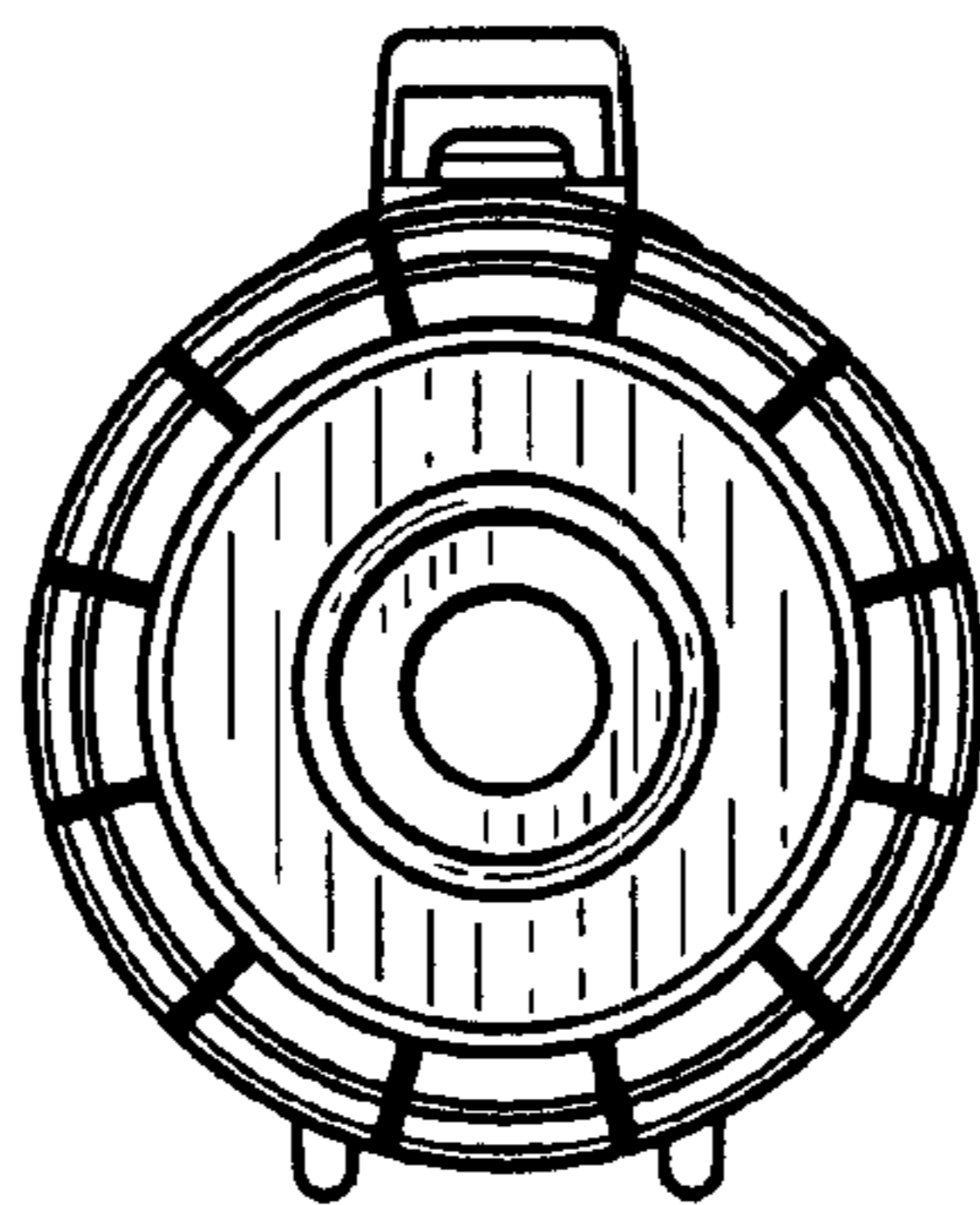

FIG. 3

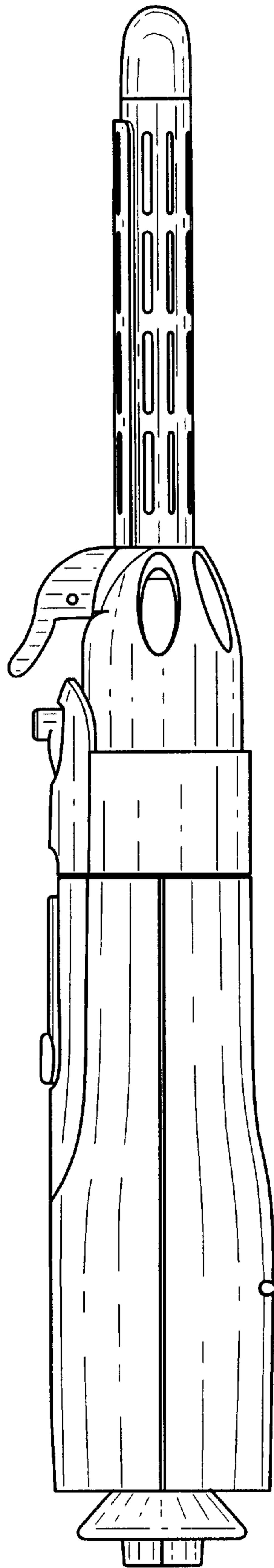

FIG. 4

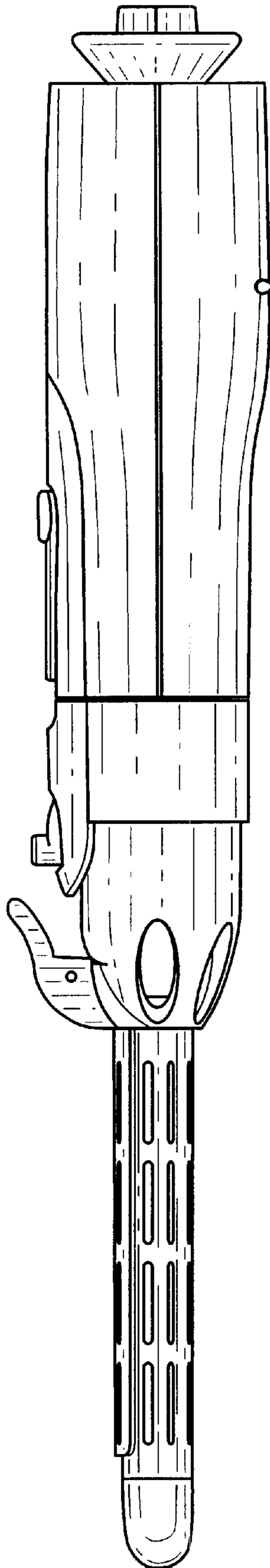

FIG. 5

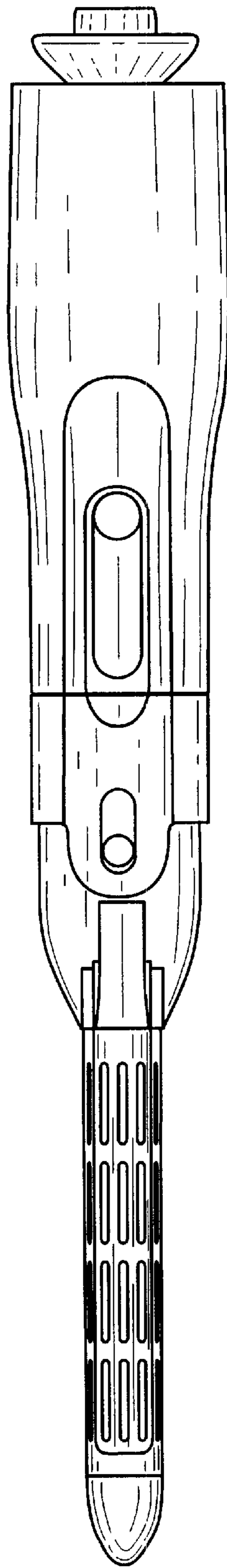

FIG. 6

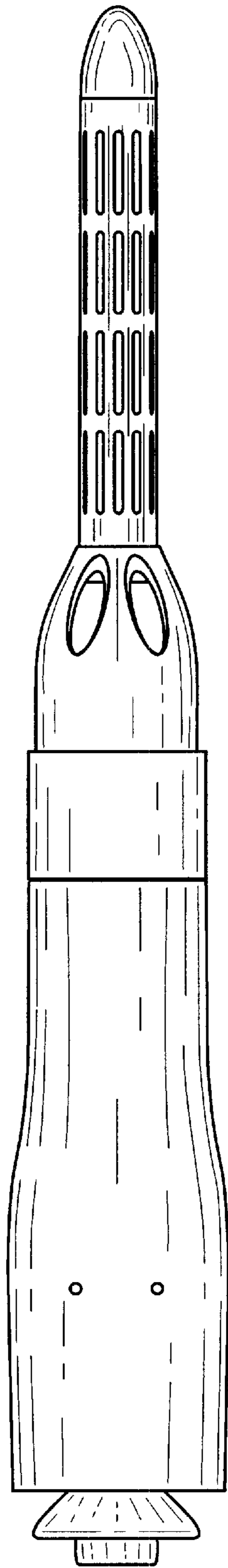

FIG. 7