



US00D454946S

(12) **United States Design Patent**
Jackson

(10) **Patent No.:** **US D454,946 S**

(45) **Date of Patent:** **** Mar. 26, 2002**

(54) **TOILET ODOR CONTROL UNIT**

Primary Examiner—Lisa Lichtenstein

(76) Inventor: **Rickey K Jackson**, 1303 E. Greenleaf Blvd., Compton, CA (US) 90221

(57) **CLAIM**

The ornamental design for a toilet odor control unit, as shown and described.

(**) Term: **14 Years**

DESCRIPTION

(21) Appl. No.: **29/138,255**

FIG. 1 is a front elevational view of the toilet odor control unit of the present invention;

(22) Filed: **Mar. 9, 2001**

FIG. 2 is a rear elevational view of the toilet odor control unit of FIG. 1;

(51) **LOC (7) Cl.** **23-04**

(52) **U.S. Cl.** **D23/366**

FIG. 3 is a right side elevational view of the toilet odor control unit of FIG. 1;

(58) **Field of Search** D23/208, 366;
4/223, 420.4

FIG. 4 is a left side elevational view of the toilet odor control unit of FIG. 1;

(56) **References Cited**

U.S. PATENT DOCUMENTS

2,614,265	A	10/1952	Vierra	
5,119,517	A	6/1992	Chang	
5,295,274	A	* 3/1994	Daniels et al.	4/223
5,673,439	A	10/1997	Kuo	
D400,642	S	* 11/1998	Morice et al.	D23/208
D400,965	S	11/1998	Akwei	
6,000,067	A	12/1999	Cascia	
6,029,286	A	2/2000	Funk	

FIG. 5 is a top plan view of the toilet odor control unit of FIG. 1;

FIG. 6 is a bottom plan view of the toilet odor control unit of FIG. 1; and,

FIG. 7 is a top, front, right side perspective view of the toilet odor control unit of FIG. 1.

The broken line showing of environmental structure in FIG. 7 is for illustrative purposes only and forms no part of the claimed design.

* cited by examiner

1 Claim, 4 Drawing Sheets

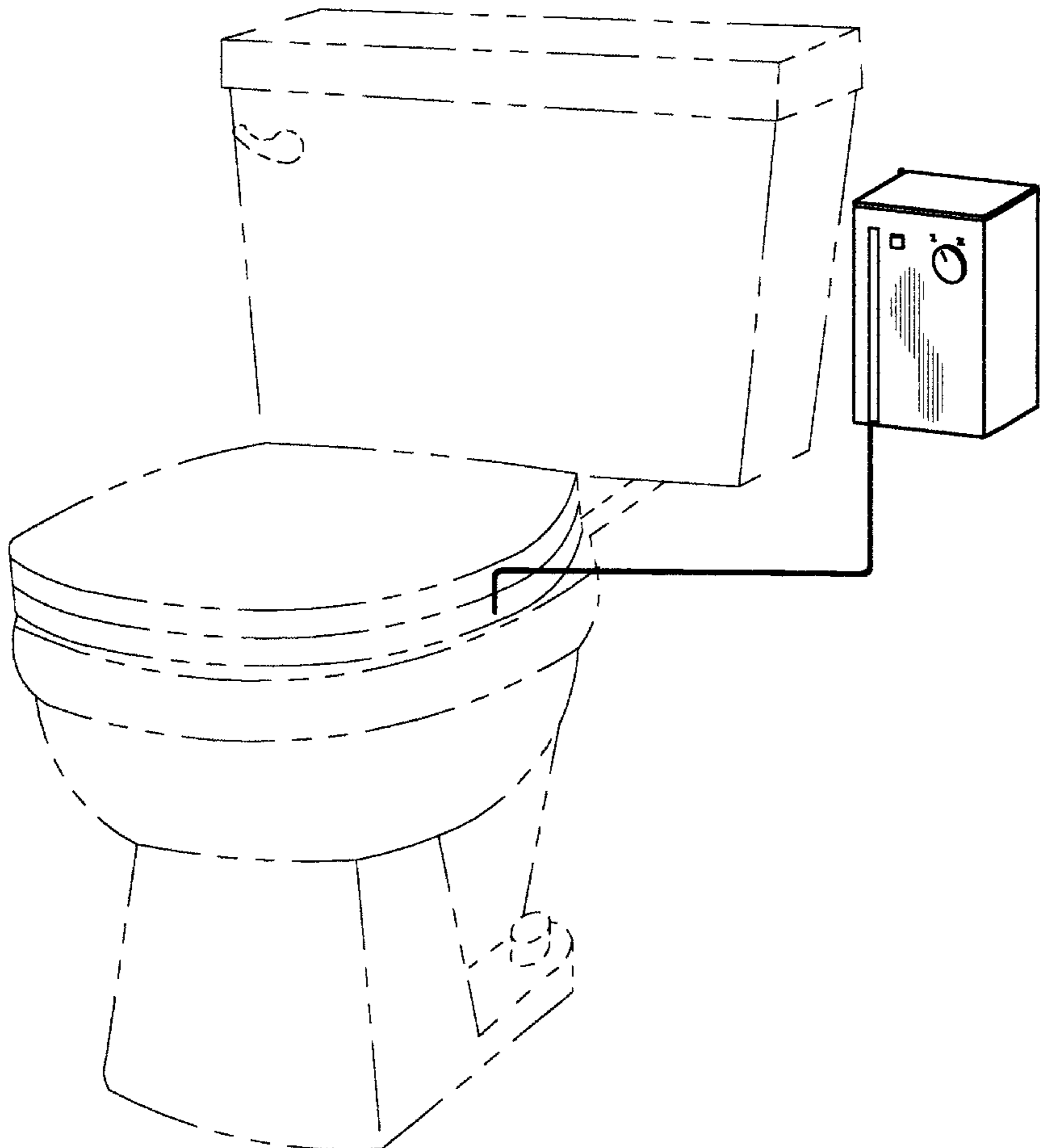

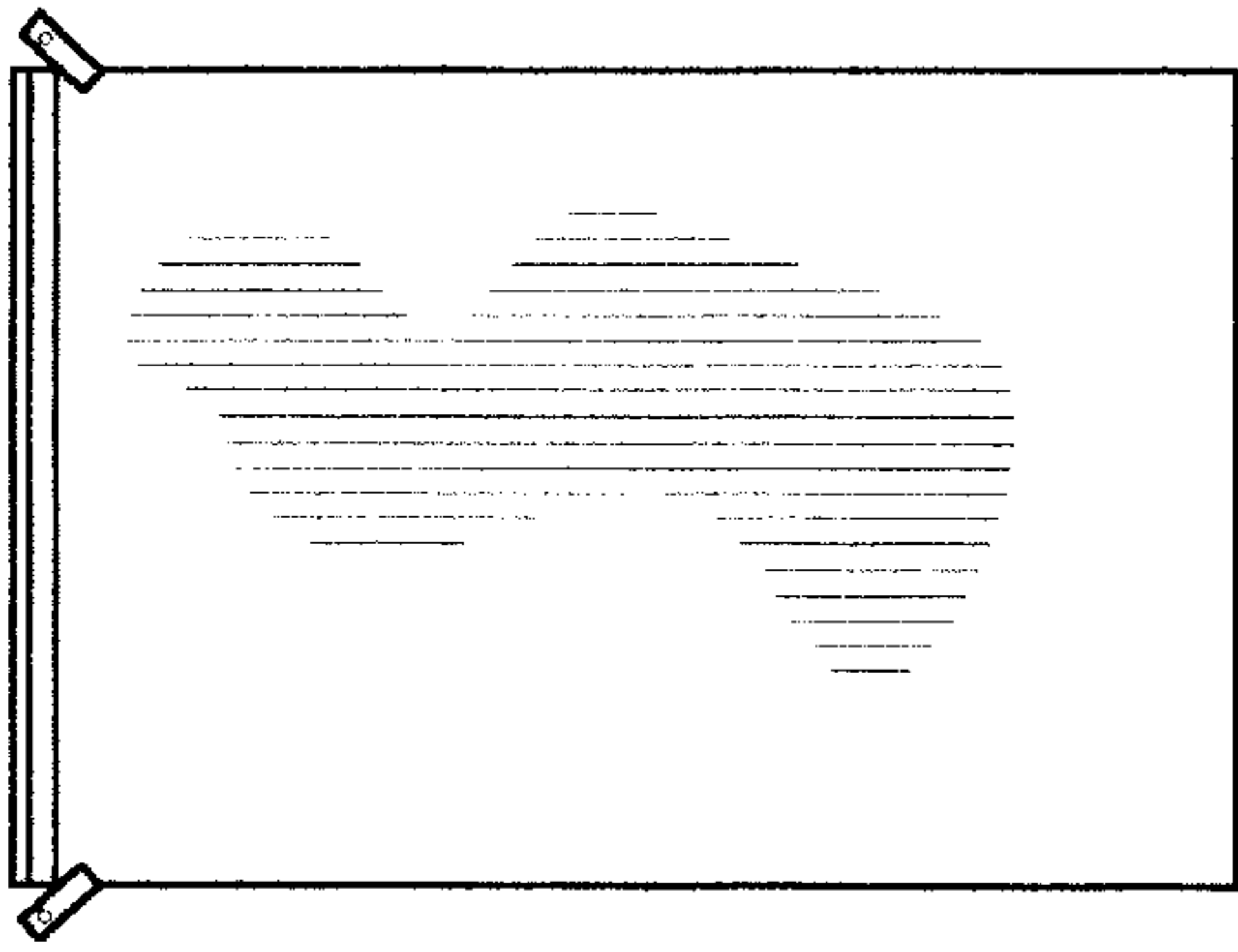

FIG. 1

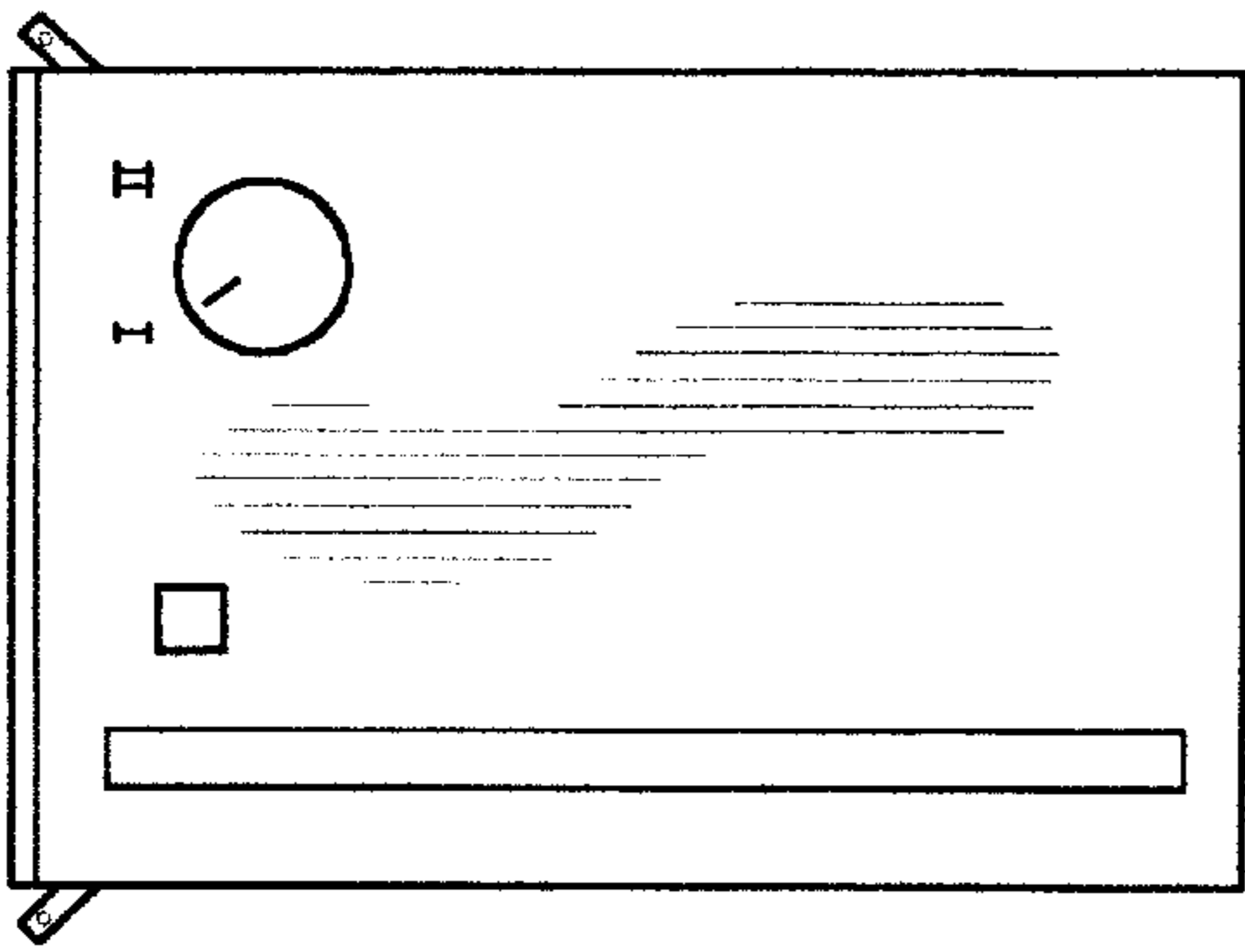

FIG. 2

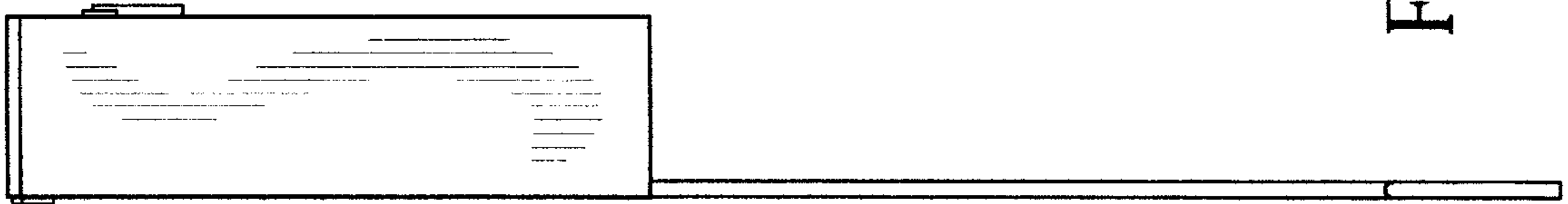

FIG. 4

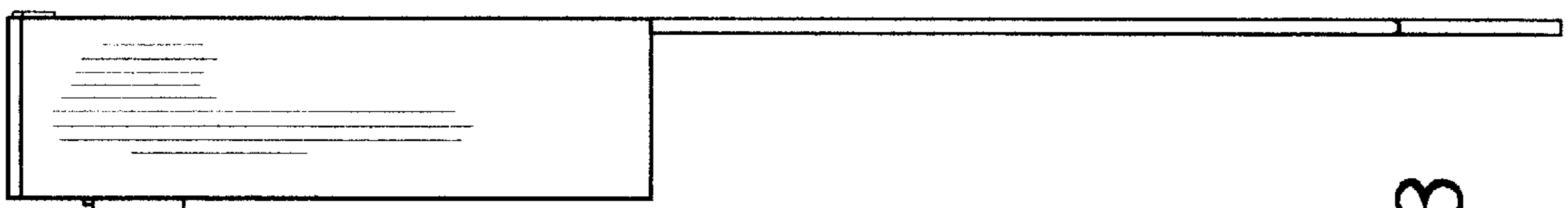

FIG. 3

FIG. 5

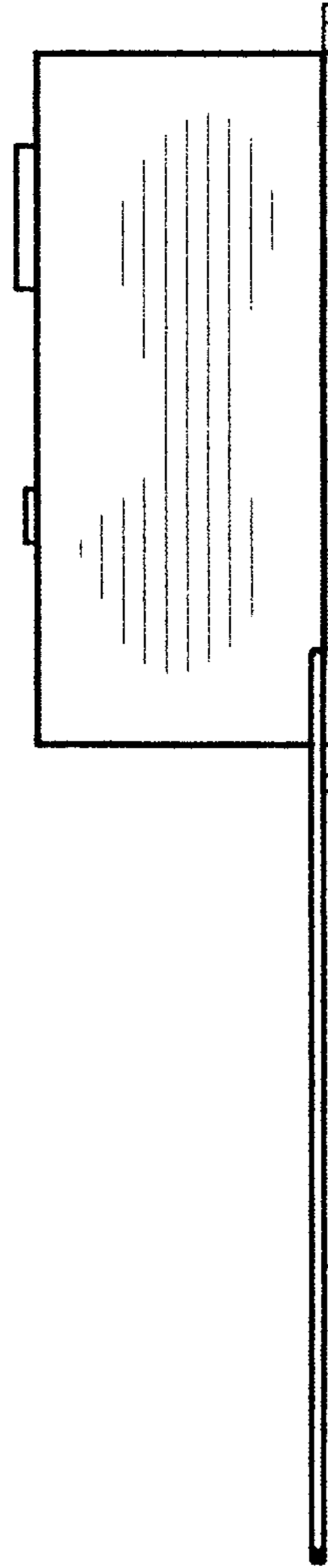
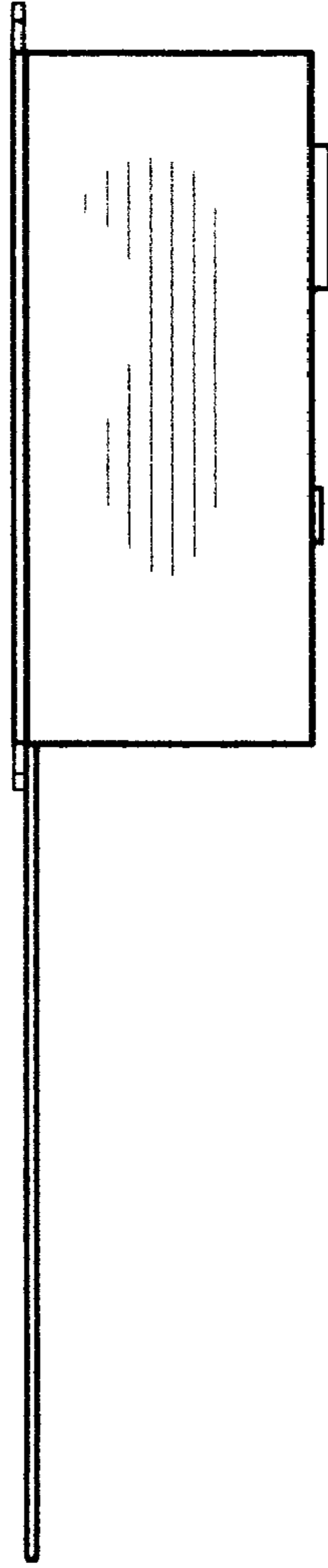

FIG. 6

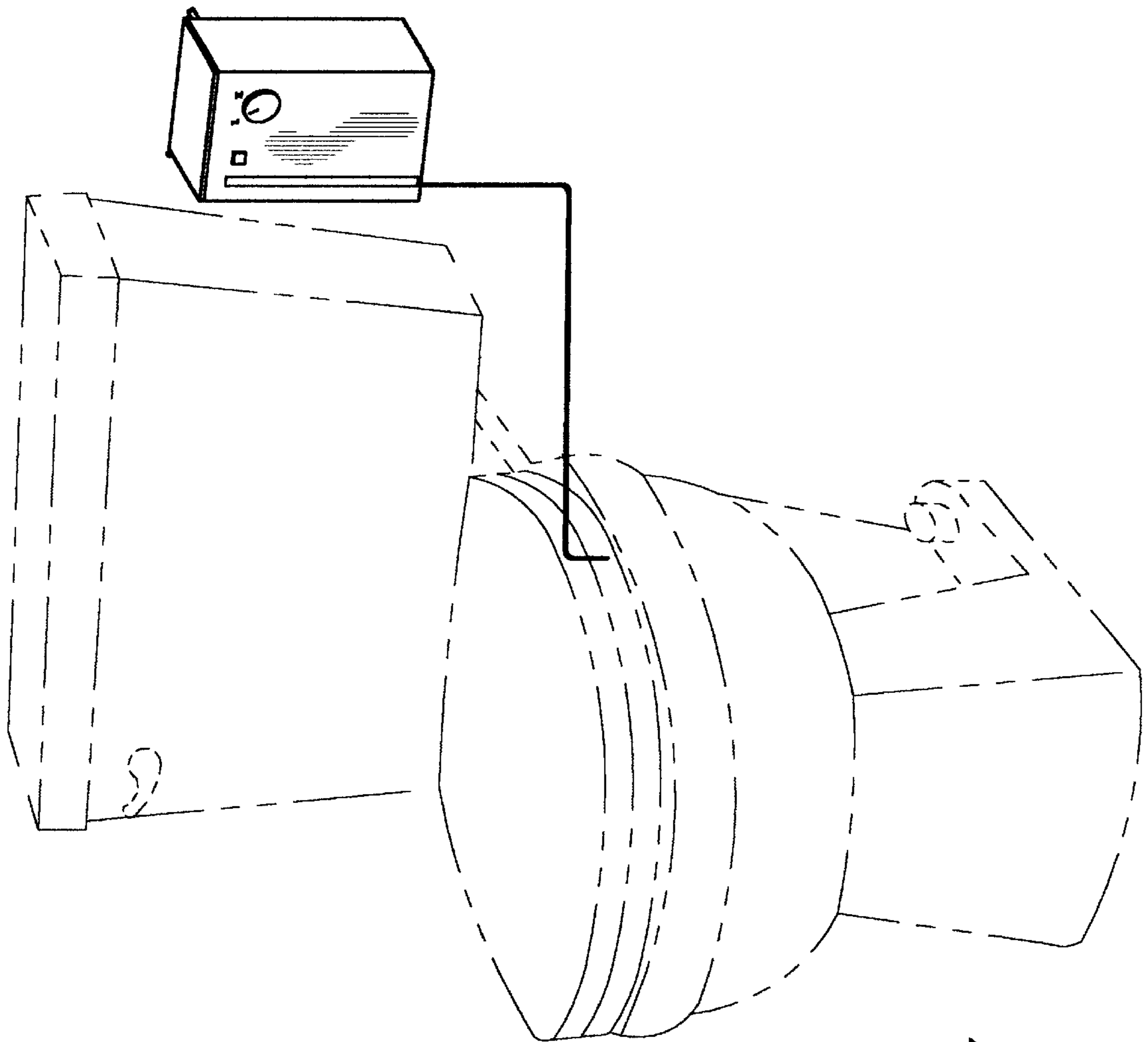

FIG. 7