



US00D454909S

(12) **United States Design Patent**
Seino et al.

(10) **Patent No.:** **US D454,909 S**

(45) **Date of Patent:** **** Mar. 26, 2002**

(54) **INK CARTRIDGE FOR PRINTER**

D431,833 S * 10/2000 Umemura D18/56
6,250,750 B1 * 6/2001 Miyazawa et al. 347/87

(75) Inventors: **Takeo Seino; Satoshi Shinada**, both of
Suwa (JP)

FOREIGN PATENT DOCUMENTS

(73) Assignee: **Seiko Epson Corporation**, Tokyo (JP)

JP 2000-014522 5/2000
JP 20000-014524 5/2000

(**) Term: **14 Years**

OTHER PUBLICATIONS

(21) Appl. No.: **29/135,985**

Pending application Ser. No. 09/122,523, filed on Apr. 28,
2000, now Des. 442,221.

(22) Filed: **Jan. 23, 2001**

* cited by examiner

(30) **Foreign Application Priority Data**

Sep. 1, 2000 (JP) 2000-024417

Primary Examiner—Cathy Anne MacCormac

(51) **LOC (7) Cl.** **18-02**

(74) *Attorney, Agent, or Firm*—Stroock & Stroock & Lavan
LLP

(52) **U.S. Cl.** **D18/56; 347/86**

(57) **CLAIM**

(58) **Field of Search** D18/56; 348/86,
348/87

The ornamental design for an ink cartridge for printer, as
shown and described.

(56) **References Cited**

DESCRIPTION

U.S. PATENT DOCUMENTS

- D365,596 S 12/1995 Miyazawa et al.
- D378,760 S 4/1997 Shinada et al.
- D381,039 S * 7/1997 Shinada et al. D18/56
- D382,296 S 8/1997 Shinada et al.
- D389,180 S * 1/1998 Miyazawa et al. D18/56
- D390,598 S 2/1998 Miyazawa et al.
- D397,143 S 8/1998 Kobayashi et al.
- D400,575 S 11/1998 Kobayashi et al.
- D425,285 S 5/2000 Shinada et al.
- D425,932 S * 5/2000 Shimizu et al. D18/56
- 6,102,533 A * 8/2000 Nozawa et al. 347/86

FIG. 1 is a top, rear and right side perspective view of an ink
cartridge for printer showing our new design;
FIG. 2 is a front, bottom and left side perspective view
thereof;
FIG. 3 is a top plan view thereof;
FIG. 4 is a front elevational view thereof;
FIG. 5 is a right side view thereof;
FIG. 6 is a left side view thereof; and,
FIG. 7 is a bottom view thereof.

1 Claim, 4 Drawing Sheets

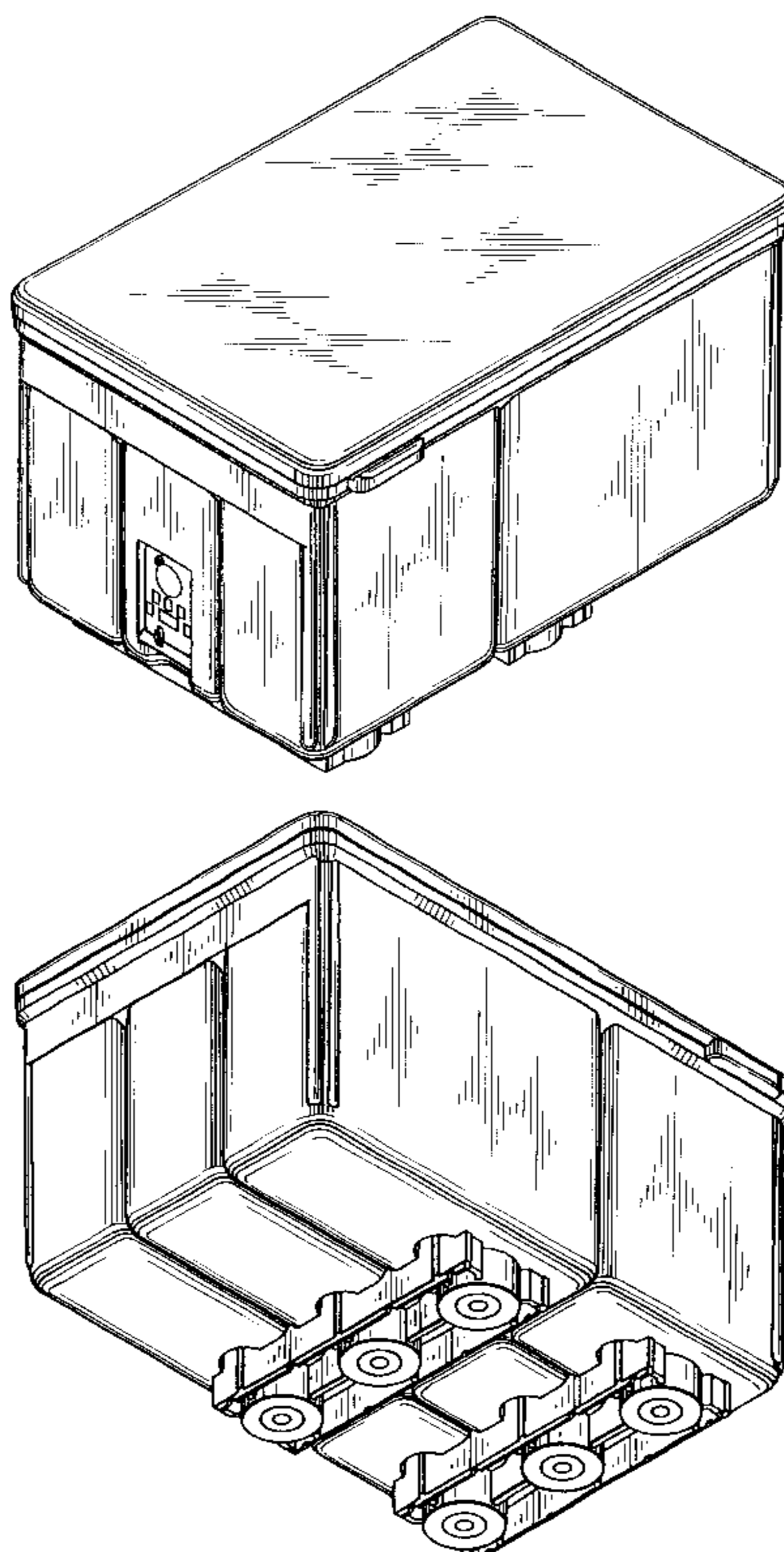

FIG. 1

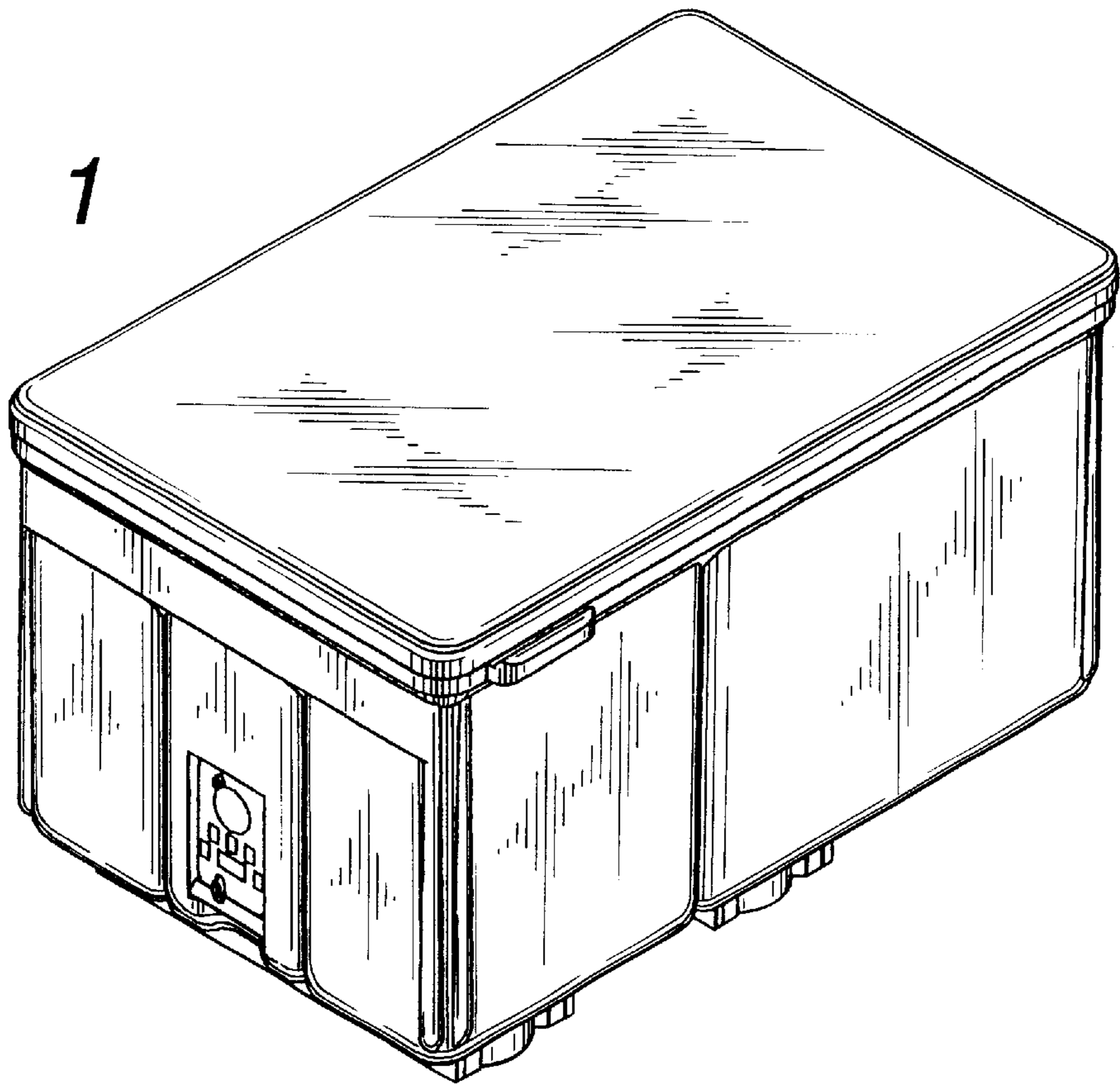

FIG. 2

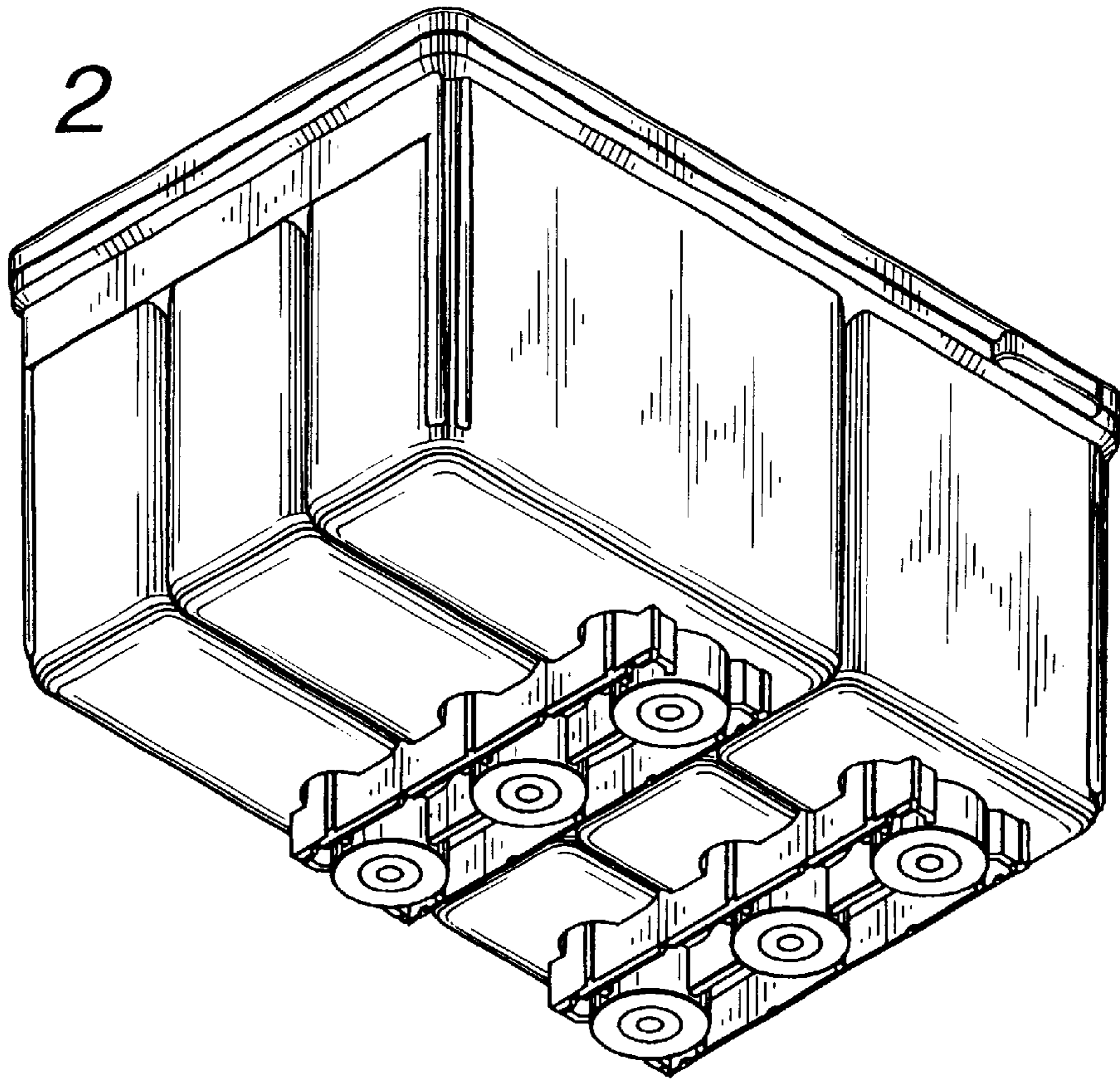

FIG. 3

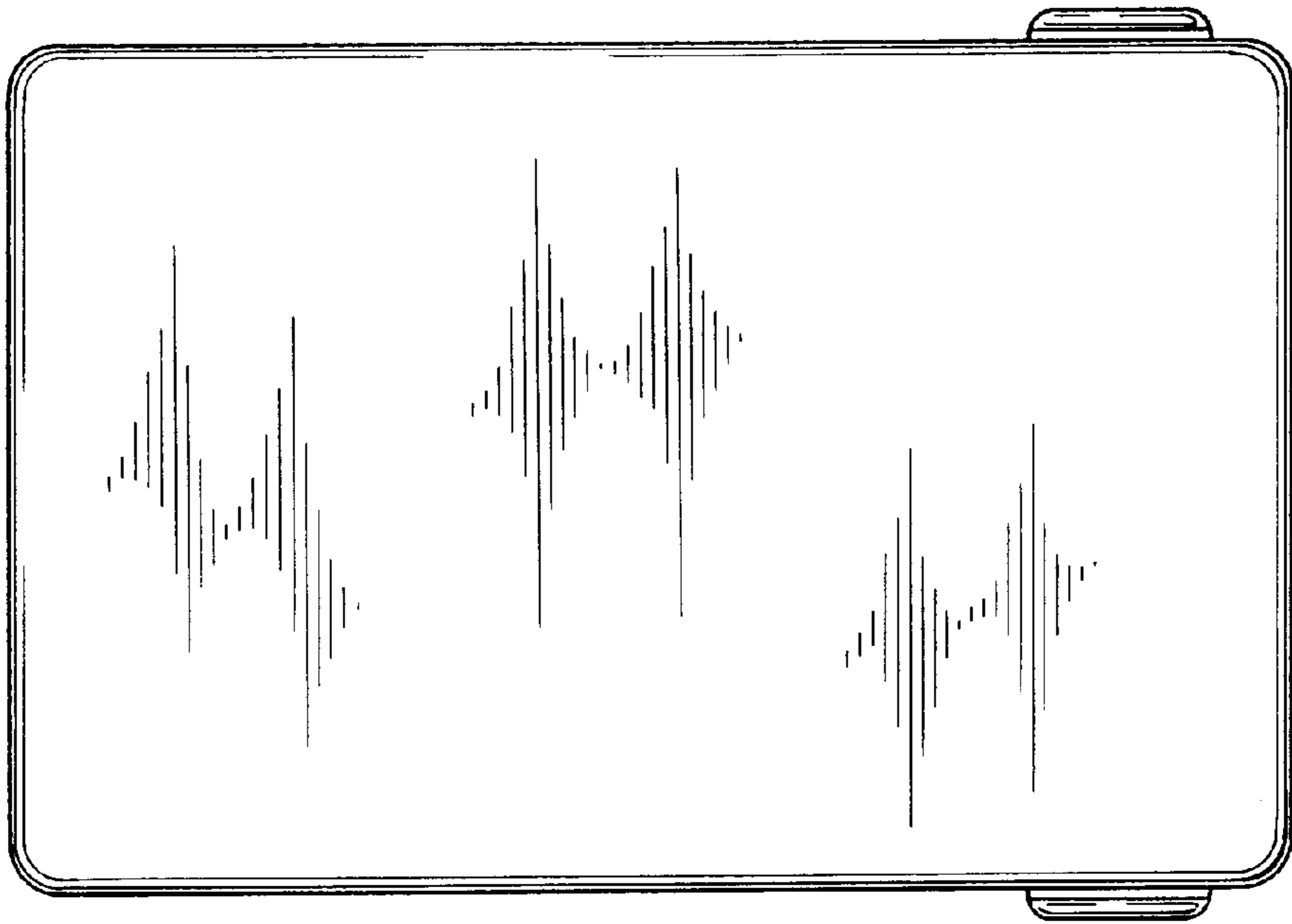

FIG. 4

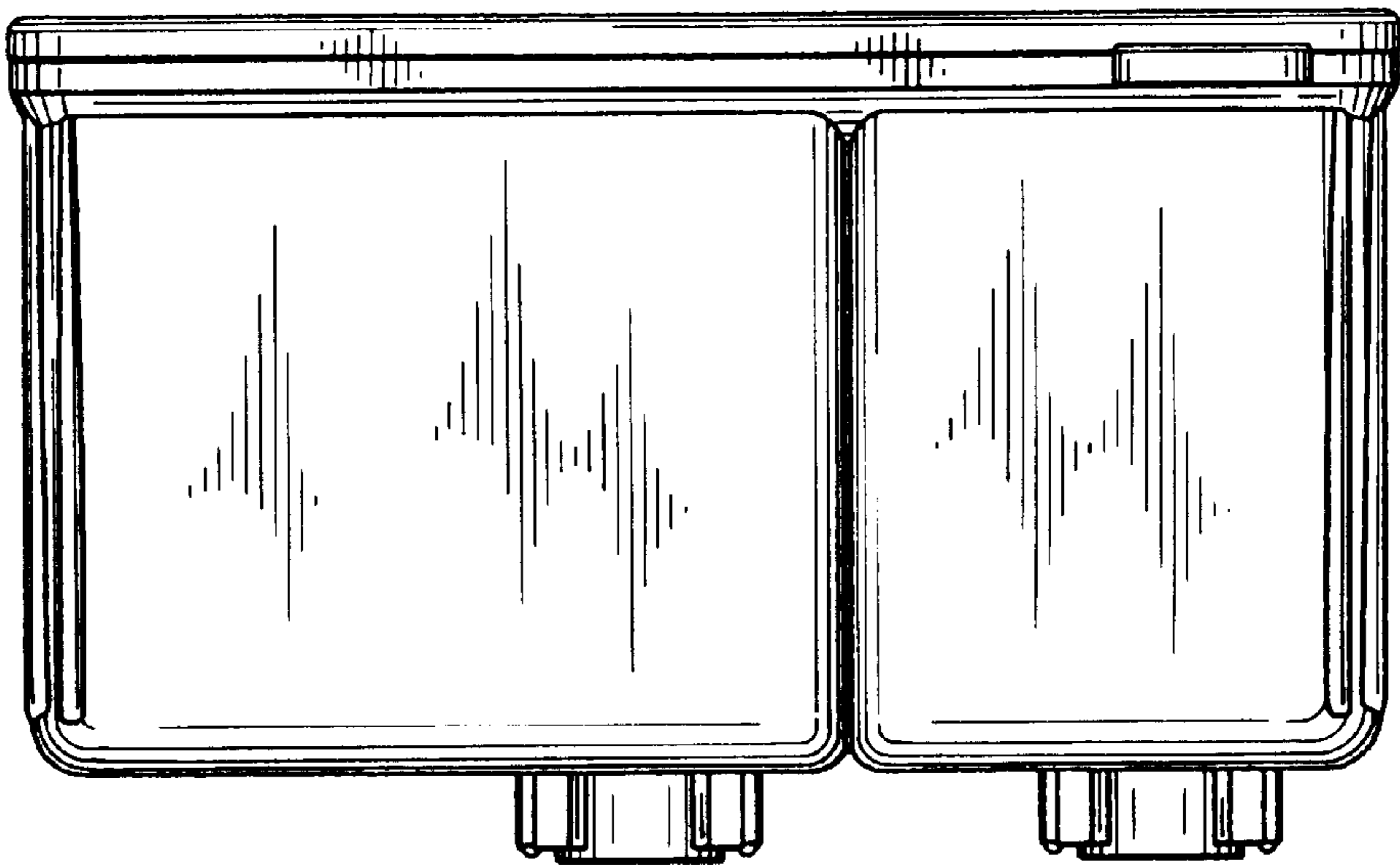

FIG. 5

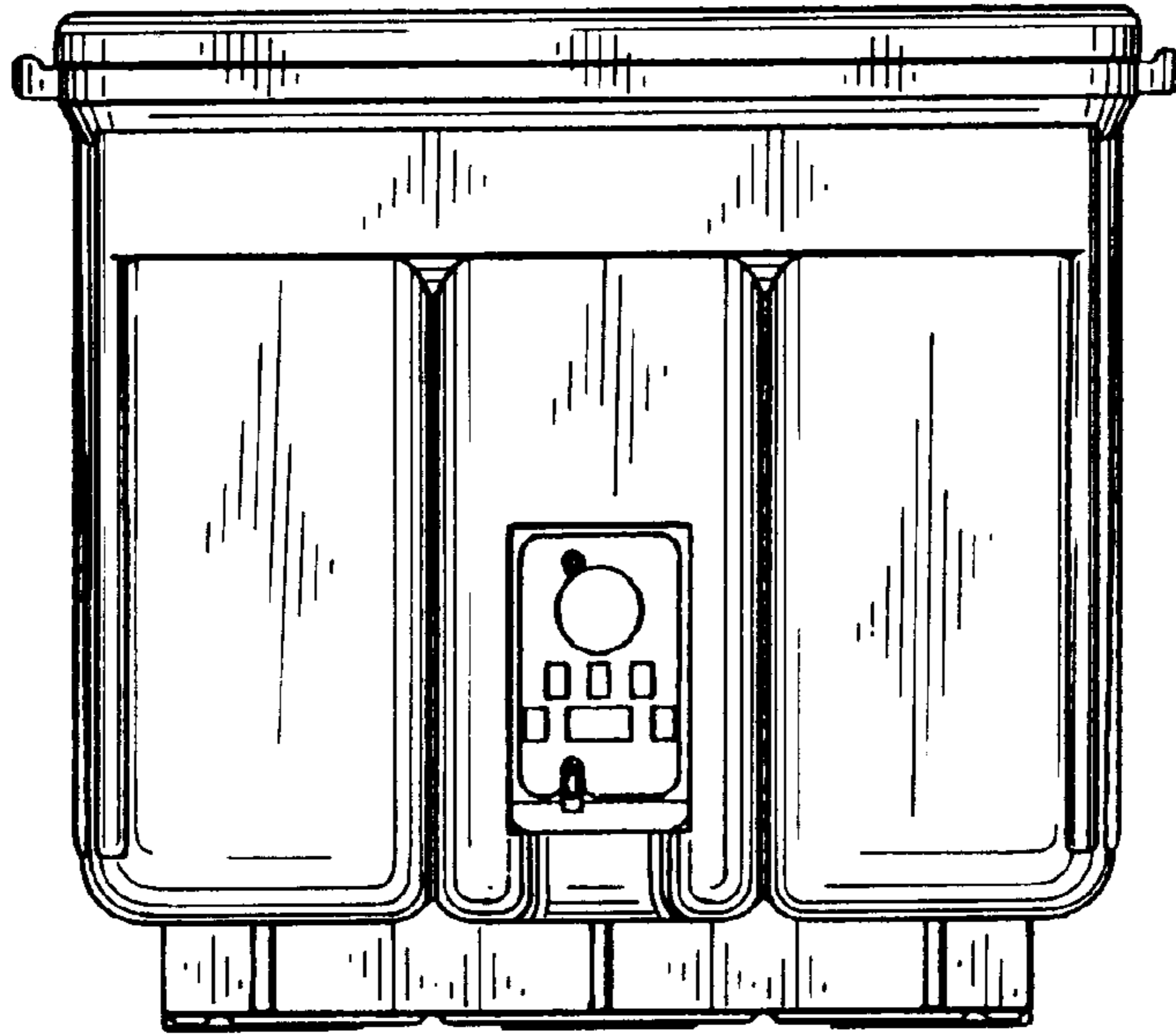

FIG. 6

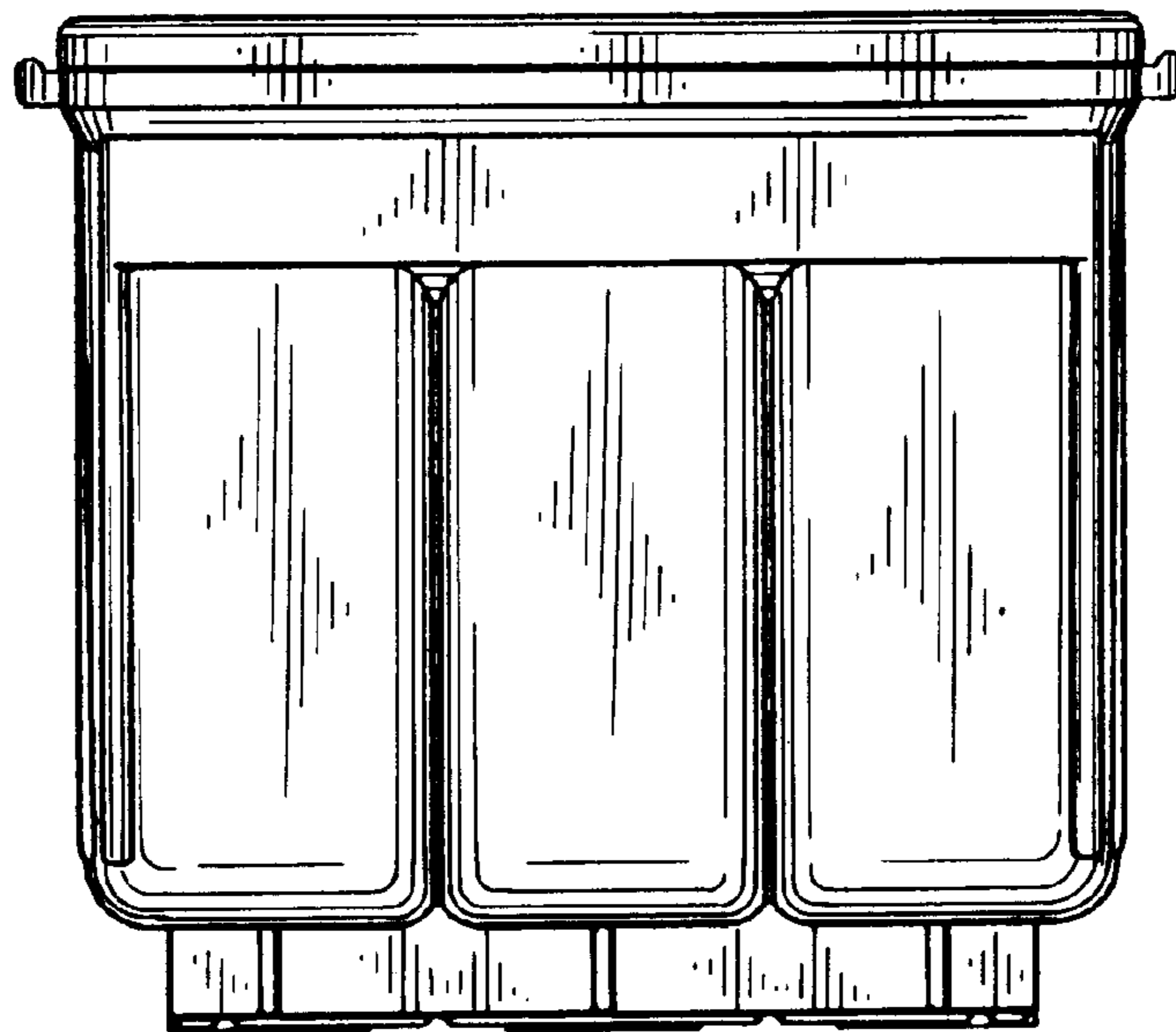

FIG. 7

