



US00D454878S

(12) **United States Design Patent**
Hayes et al.

(10) **Patent No.:** **US D454,878 S**
(45) **Date of Patent:** **** Mar. 26, 2002**

(54) **ADVANCED GAME PAD**

(75) Inventors: **Kevin Hayes**, Santa Monica; **Antonino C. Mattina**, Pasadena; **Brian Matthew Michaelis**, Loma Linda; **Kenneth Mori**; **Ernesto V. Quinteros**, both of Los Angeles; **Mark R. Westcott**, Newbury Park, all of CA (US)

(73) Assignee: **Belkin Components**, Compton, CA (US)

(**) Term: **14 Years**

(21) Appl. No.: **29/132,554**

(22) Filed: **Nov. 10, 2000**

(51) **LOC (7) Cl.** **14-02**

(52) **U.S. Cl.** **D14/401**

(58) **Field of Search** D14/412-416,
D14/400, 401, 496; D21/324, 328, 333;
223/148 B, 148 R; 463/1, 2, 29-38, 46,
47; 345/156, 157, 161

(56) **References Cited**

U.S. PATENT DOCUMENTS

D412,017 S	*	7/1999	Sramek et al.	D21/329
D415,752 S	*	10/1999	Tyler et al.	D14/401
D417,664 S	*	12/1999	Goto	D14/401
D424,047 S	*	5/2000	Chan	D14/401
6,171,191 B1	*	1/2001	Ogata et al.	273/148 B
6,186,896 B1	*	2/2001	Takeda et al.	273/148 B
6,231,444 B1	*	5/2001	Goto et al.	273/148 B

OTHER PUBLICATIONS

Logitech. Description of WingMan® Rumble Pad™ product [online], [retrieved on Apr. 3, 2001]. Retrieved from the Internet <URL:http://www.logitech.com/cf/products/productoverview.cfm/76>.

Logitech. Description of WingMan® Precision™ Gamepad product [online], [retrieved on Apr. 3, 2001]. Retrieved from the Internet <URL:http://www.logitech.com/cf/products/productoverview.cfm/68>.

Logitech. Description of WingMan® Gamepad Extreme™ product [online], [retrieved on Apr. 3, 2001]. Retrieved from the Internet <URL:http://www.logitech.com/cf/products/productoverview.cfm/24>.

Logitech. Description of WingMan® Gamepad Gameport/USB Combo product [online], [retrieved on Apr. 3, 2001]. Retrieved from the Internet <URL:http://www.logitech.com/cf/products/productoverview.cfm/25>.

Gravis. Description of Eliminator Stinger™ Laptop Game Pad product [online], [retrieved on Mar. 8, 2001]. Retrieved from the Internet <URL:http://www.gravis.com/products/pro_eli_d1018.html>.

Microsoft. Description of Microsoft® Side Winder® Freestyle Pro product [online], [retrieved on Mar. 9, 2001]. Retrieved from the Internet <URL:http://www.microsoft.com/products/hardware/sidewinder/tilt/>.

Gravis. Description of Eliminator Aftershock product [online], [retrieved on Mar. 8, 2001]. Retrieved from the Internet <URL:http://www.gravis.com/products/pro_eli_d1022.html>.

Gravis. Description of Eliminator Gamepad Pro product [online], [retrieved on Mar. 8, 2001]. Retrieved from the Internet <URL:http://www.gravis.com/products/pro_eli_d1020.html>.

(List continued on next page.)

Primary Examiner—Prabhakar Deshmukh

(74) *Attorney, Agent, or Firm*—Bryan Cave LLP

(57) **CLAIM**

We claim the ornamental design for the advanced game pad, as shown.

DESCRIPTION

FIG. 1 is a top plan view of an advanced game pad; FIG. 2 is a front elevational view thereof; FIG. 3 is a rear elevational view thereof; FIG. 4 is a left elevational view thereof; FIG. 5 is a right elevational view thereof; FIG. 6 is a bottom plan view thereof; FIG. 7 is a top, right, rear, perspective view thereof; and, FIG. 8 is a bottom, left, front, perspective view thereof.

1 Claim, 6 Drawing Sheets

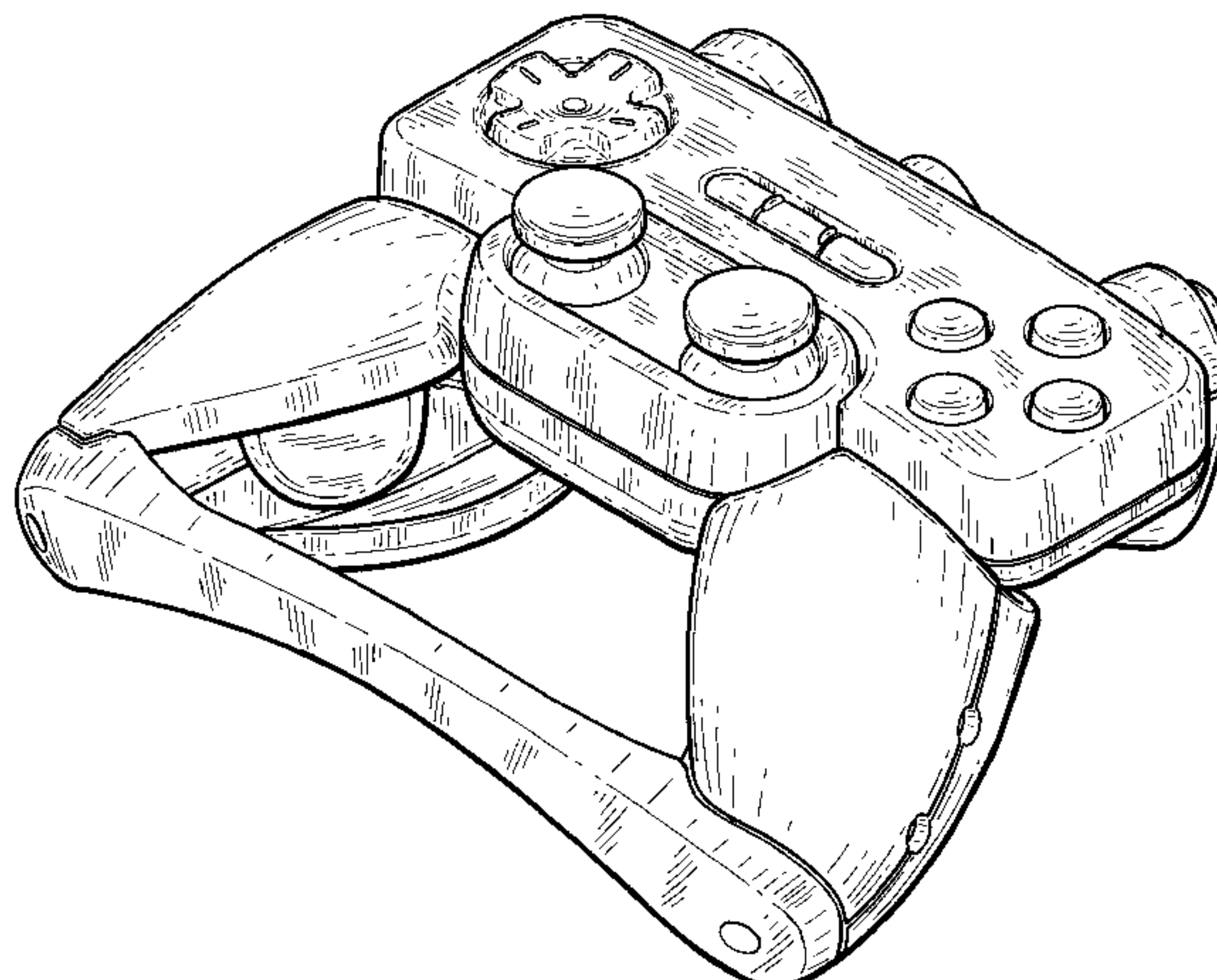

OTHER PUBLICATIONS

Gravis. Description of Eliminator GamePad Pro USB product [online], [retrieved on Mar. 8, 2001]. Retrieved from the Internet <URL:http://www.gravis.com/products/pro_eli_d1019.html>.

Gravis. Description of GamePad Pro product [online], [retrieved on Mar. 8, 2001]. Retrieved from the Internet <URL:http://www.gravis.com/products/pro_eli_d1021.html>.

Gravis. Description of Destroyer Tilt GamePad product [online], [retrieved on Mar. 8, 2001]. Retrieved from the Internet <URL:http://www.gravis.com/products/pro_eli_d1016.html>.

Gravis. Description of Destroyer PC GamePad product [online], [retrieved on Mar. 8, 2001]. Retrieved from the Internet <URL:http://www.gravis.com/products/pro_eli_d1013.html>.

Microsoft. Description of Sidewinder Dual Strike product [online], [retrieved on Mar. 9, 2001]. Retrieved from the Internet <URL:<http://www.microsoft.com/products/hardware/sidewinder/devices/DualS/default.htm>>.

Microsoft. Description of Game Pad Pro product [online], [retrieved on Mar. 9, 2001]. Retrieved from the Internet <URL:<http://www.microsoft.com/products/hardware/sidewinder/devices/GPpro/default.htm>>.

Microsoft. Description of Plug & Play Game Pad product [online], [retrieved on Mar. 9, 2001], Retrieved from the Internet <URL:<http://microsoft.com/products/hardware/sidewinder/devices/PlugPlay/default.htm>>.

Sony. Description of Dualshock 2 analog controller product [online], [retrieved on Mar. 9, 2001], Retrieved from the Internet <URL:http://www.us.playstation.com/product_detail.jhtml?PRODID=11&CATID=40>.

Sony. Description of DualShock analog controller product [online], [retrieved on Mar. 9, 2001], Retrieved from the Internet <URL:http://www.us.playstation.com/product_detail.jhtml?PRODID=4&CATID=40>.

Saitek. Description of PX4000 PlayStation™ 2 Pad product [online], [retrieved on Mar. 14, 2001], Retrieved from the Internet <URL:<http://www.saitekusa.com/product/px4000.htm>>.

Saitek. Description of P120 Action Pad product [online], [retrieved on Mar. 8, 2001], Retrieved from the Internet <URL:<http://www.saitekusa.com/product/p120.htm>>.

Saitek. Description of P150 USB Action Pad product [online], [retrieved on Mar. 8, 2001], Retrieved from the Internet <URL:<http://www.saitekusa.com/product/p150.htm>>.

Saitek. Description of P750 Digital Control Pad product [online][retrieved on Mar. 8, 2001]. Retrieved from the Internet <URL:<http://www.saitekusa.com/product/p750.htm>>.

Saitek. Description of P1500 Rumble Pad product [online] [retrieved on Mar. 8, 2001]. Retrieved from the Internet <URL:<http://www.saitekusa.com/product/p1500.htm>>.

Saitek. Description of P2000 Tilt Pad product [online] [retrieved on Mar. 8, 2001]. Retrieved from the Internet <URL:<http://www.saitekusa.com/product/p2000.htm>>.

NYKO. Description of DC Commander product [online] [retrieved on Mar. 9, 2001]. Retrieved from the Internet <URL:<http://www.nyko.com/html/80201.html>>.

NYKO. Description of Fire Pad product [online][retrieved on Mar. 9, 2001]. Retrieved from the Internet <URL:<http://www.nyko.com/html/80003.html>>.

NYKO. Description of Hyper Alpha 64 product [online] [retrieved on Mar. 9, 2001]. Retrieved from the Internet <URL:<http://www.nyko.com/html/81020.html>>.

NYKO. Description of Action Pad product [online], [retrieved on Mar. 9, 2001]. Retrieved from the Internet <URL:<http://www.nyko.com/html/80009.html>>.

* cited by examiner

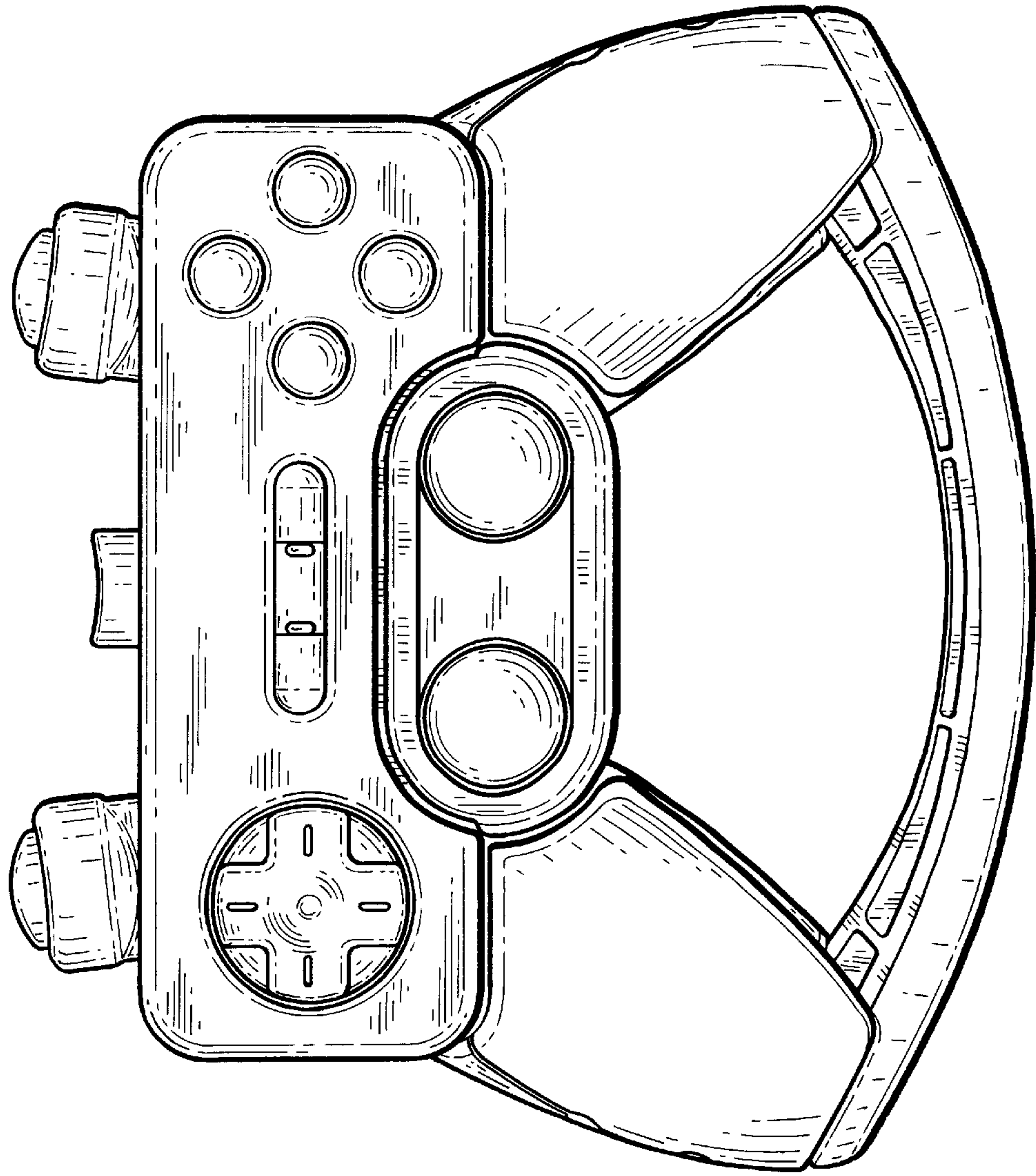

FIG. 1

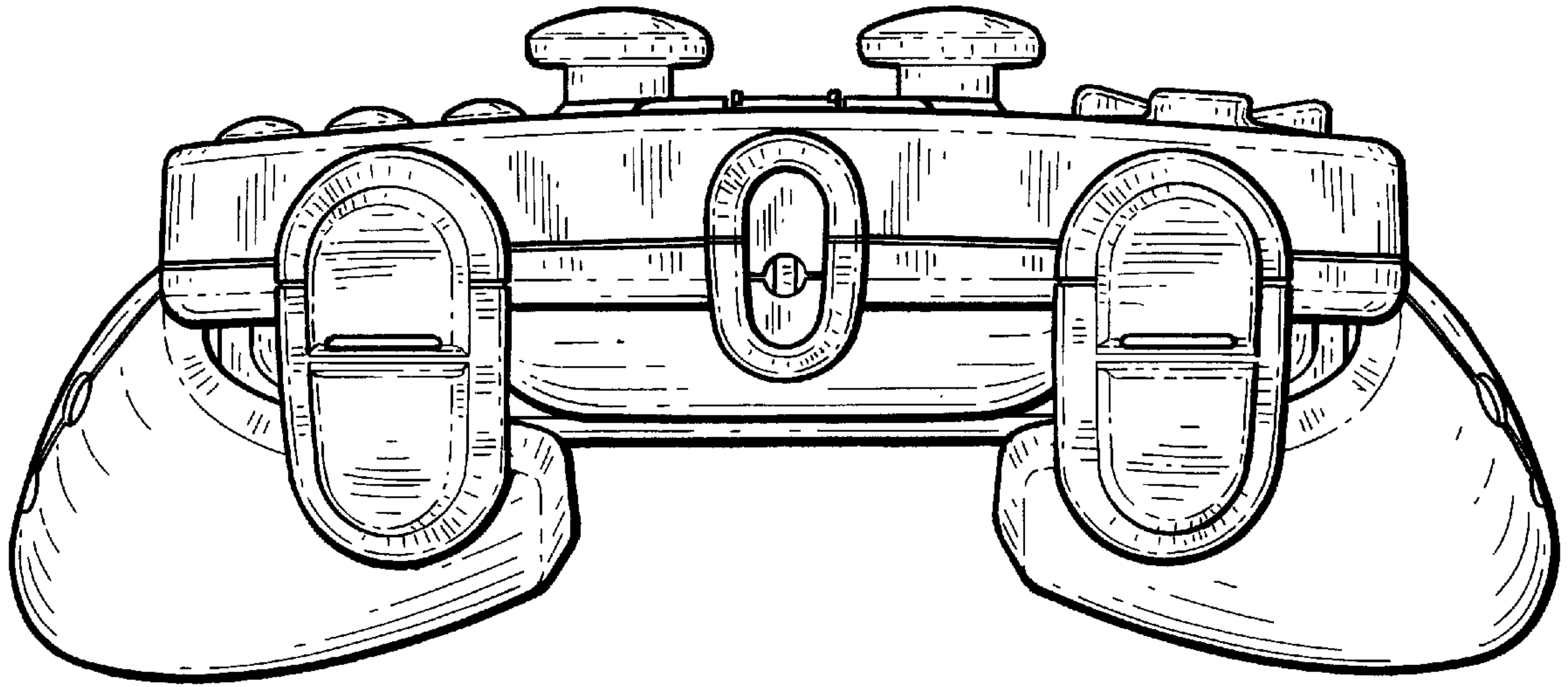

FIG. 2

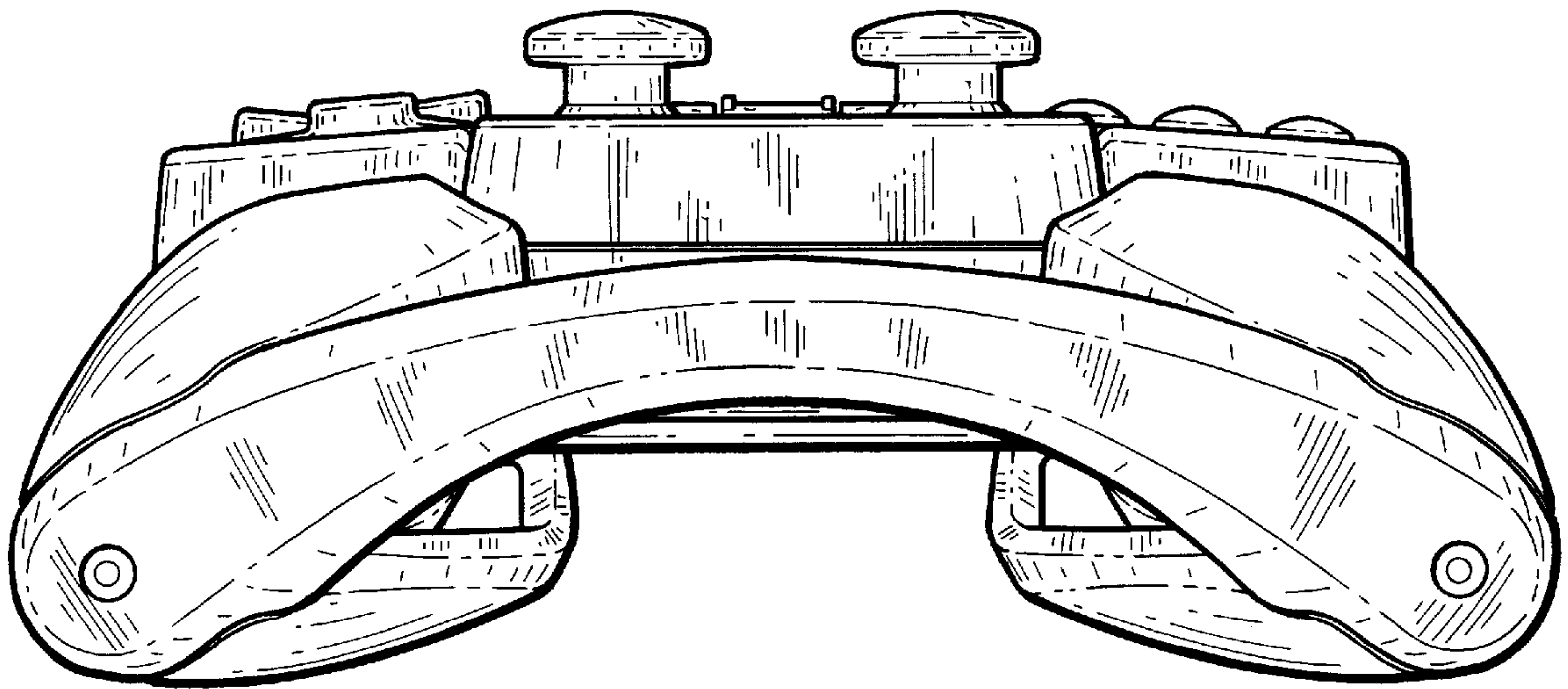

FIG. 3

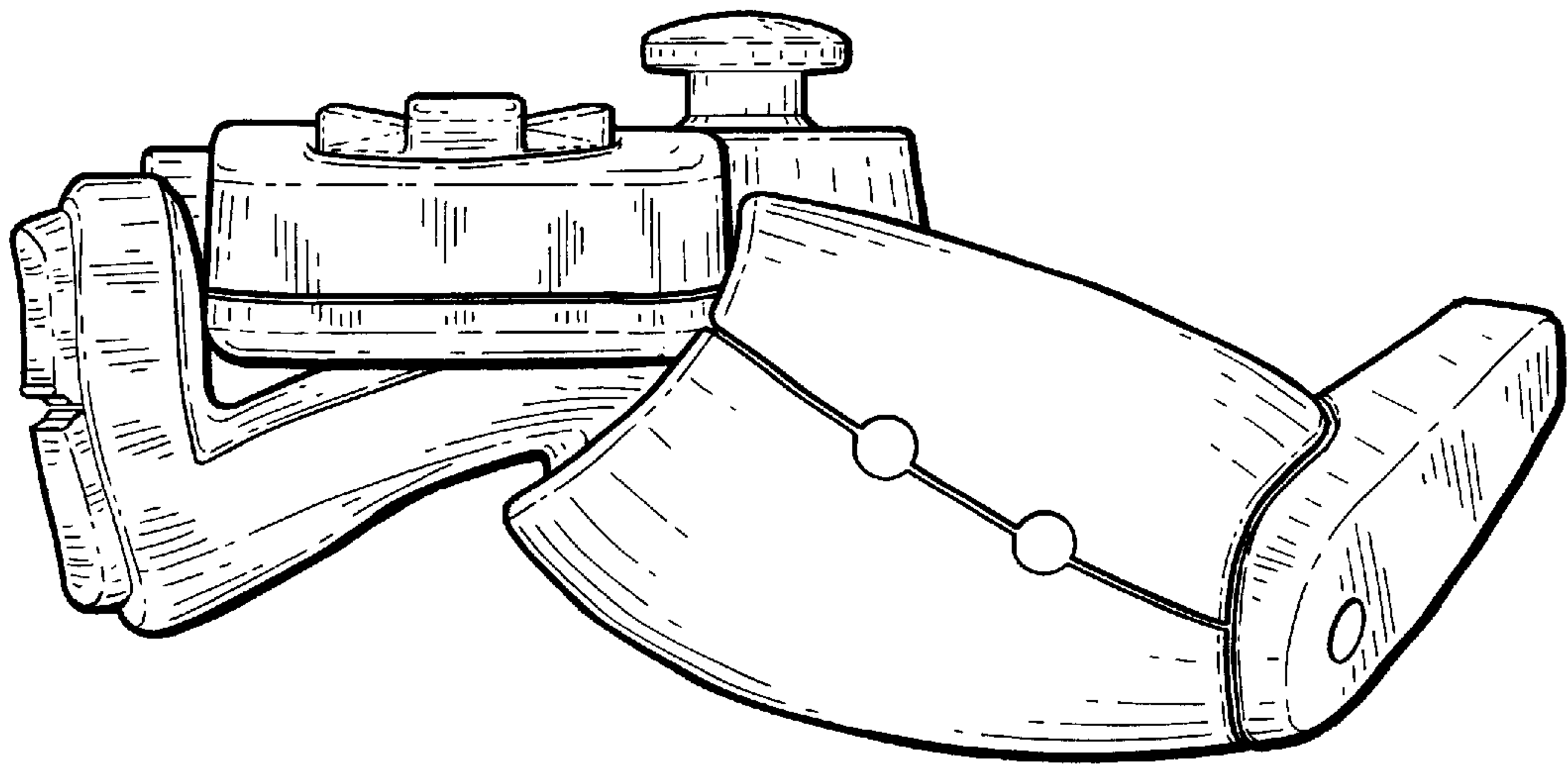

FIG. 4

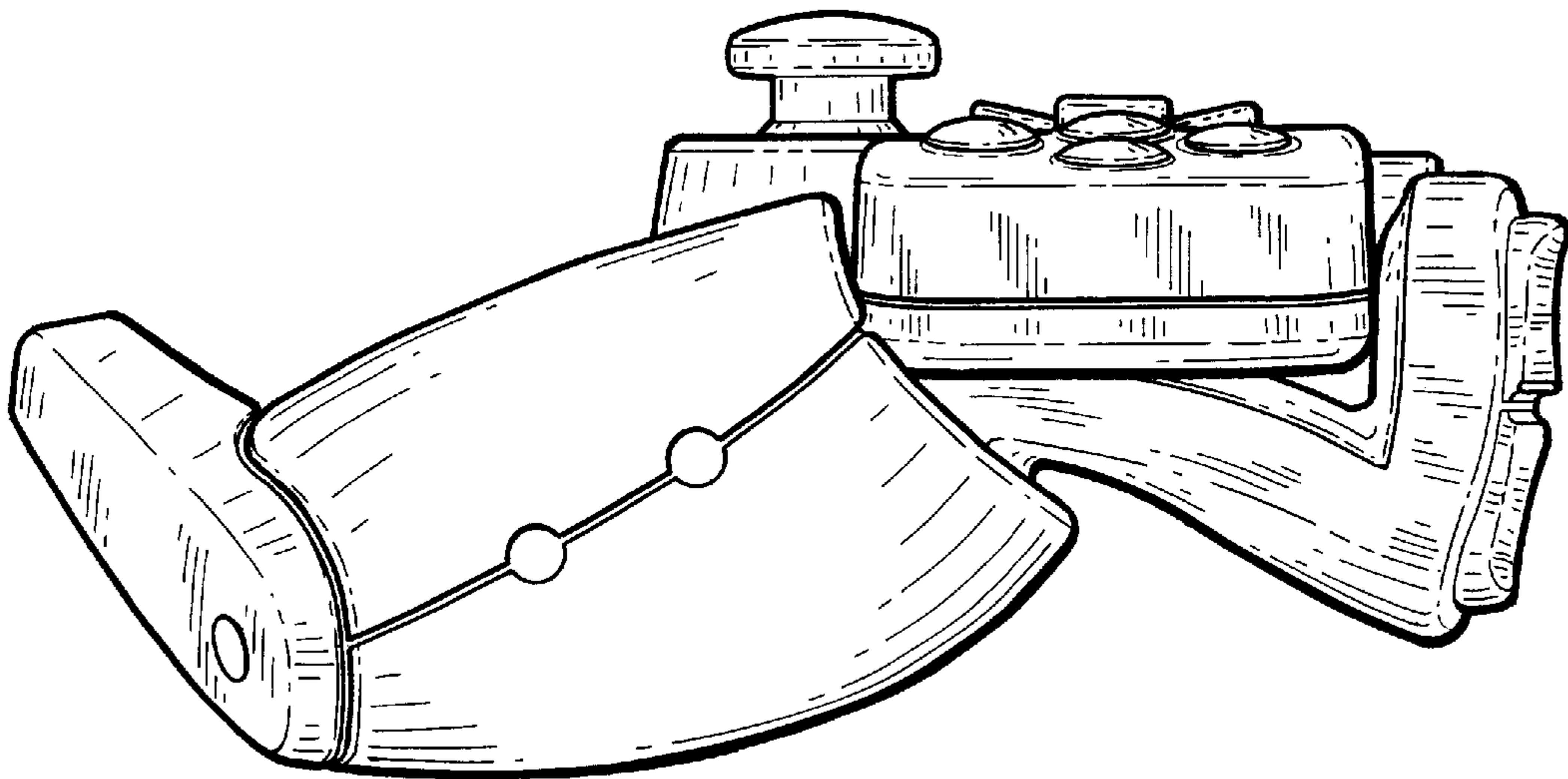

FIG. 5

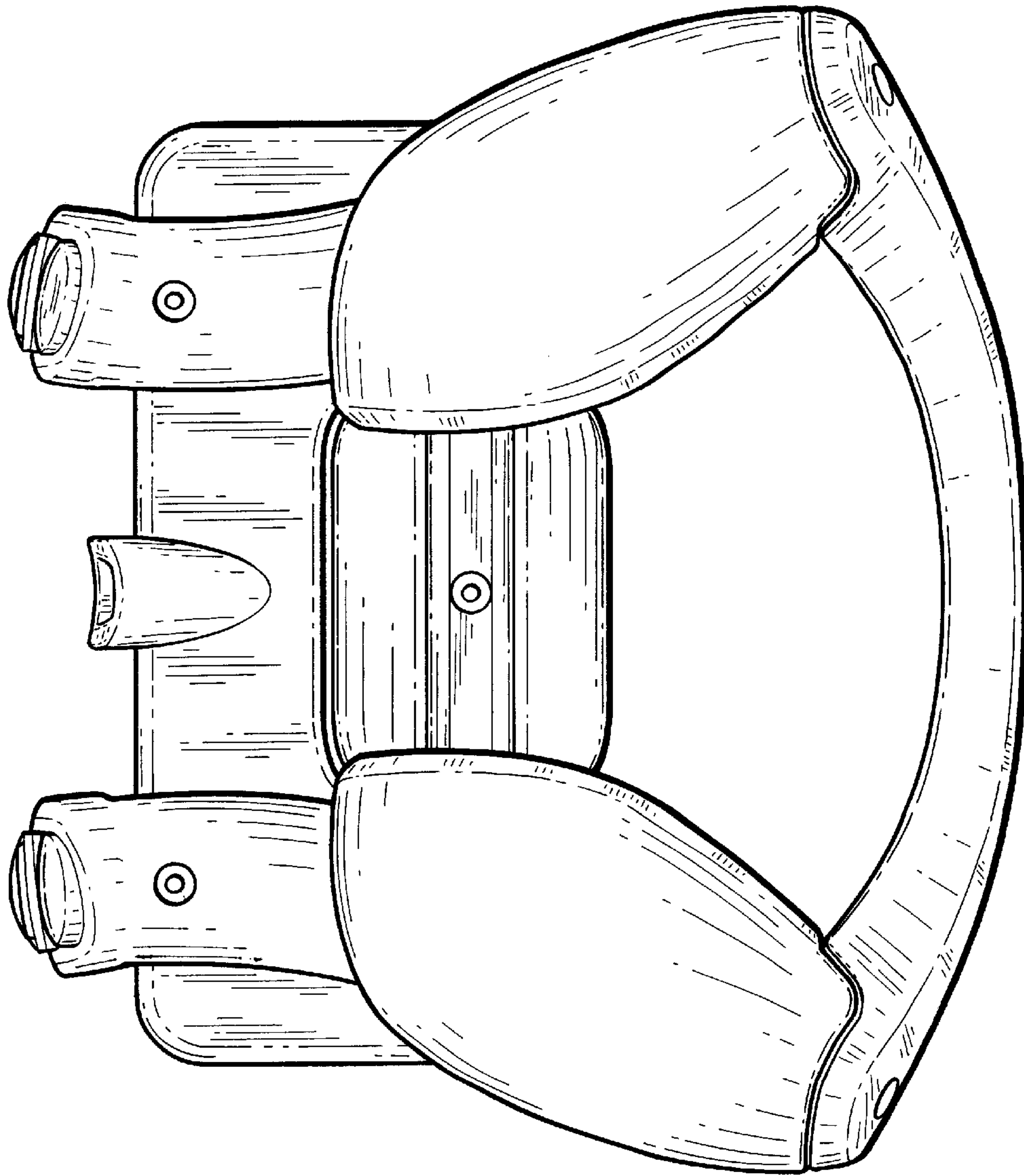

FIG. 6

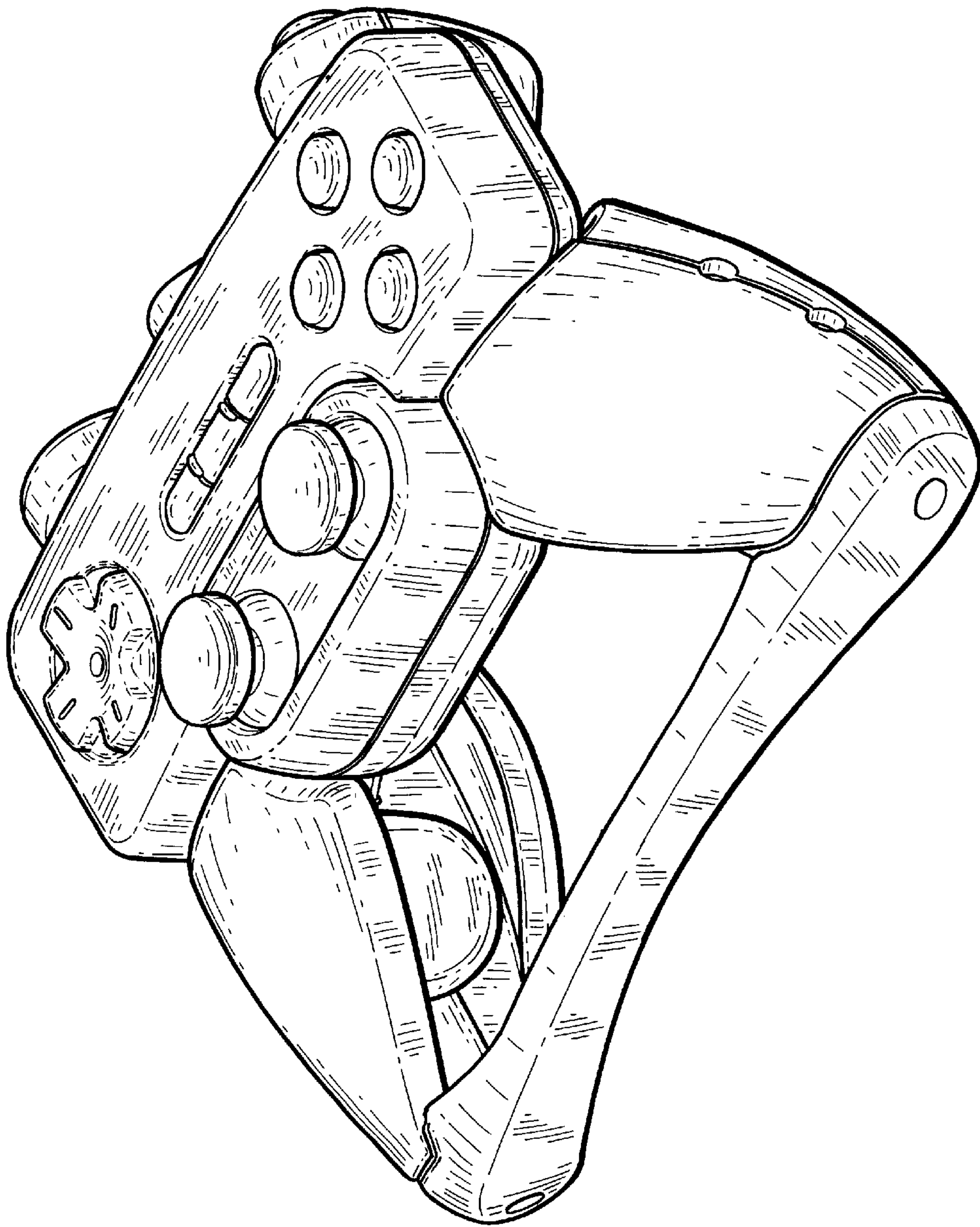

FIG. 7

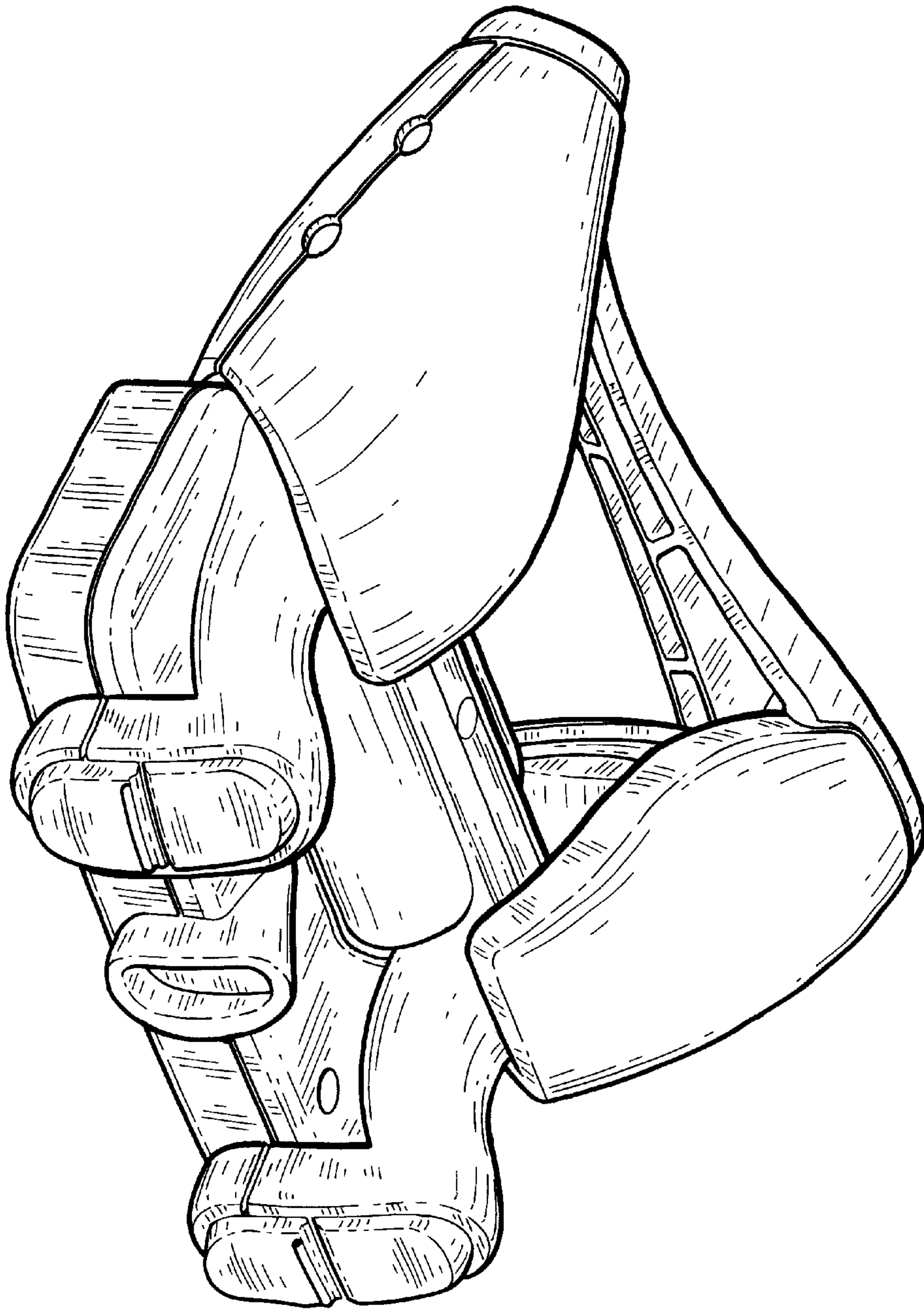

FIG. 6