



US00D454855S

(12) **United States Design Patent**
Nakane

(10) **Patent No.:** **US D454,855 S**
(45) **Date of Patent:** **** Mar. 26, 2002**

(54) **DIGITAL AUDIO DISC PLAYER EQUIPPED WITH MIXING FUNCTION**

CDJ-300 of Pioneer Electronic Corporation, 2 pages, Jul. 1997.

(75) Inventor: **Koji Nakane**, Tokyo (JP)

CDJ-500II Limited of Pioneer Electronic Corporation, 2 pages, Sep. 1997.

(73) Assignee: **Pioneer Corporation**, Tokyo (JP)

* cited by examiner

(**) Term: **14 Years**

Primary Examiner—Nanda Bondade

(21) Appl. No.: **29/140,007**

(74) *Attorney, Agent, or Firm*—Oblon, Spivak, McClelland, Maier & Neustadt, P.C.

(22) Filed: **Apr. 11, 2001**

(30) **Foreign Application Priority Data**

(57) **CLAIM**

Oct. 16, 2000 (JP) 2000-029082

The ornamental design for a digital audio disc player equipped with mixing function, as shown and described.

(51) **LOC (7) Cl.** **14-01**

DESCRIPTION

(52) **U.S. Cl.** **D14/168; D14/156**

FIG. 1 is a top, front and right side perspective view of a digital audio disc player equipped with mixing function showing my new design;

(58) **Field of Search** D14/135-136, D14/156, 160-162, 167-168, 188, 217; 369/75.1, 75.2, 77.1, 77.2

FIG. 2 is a front elevational view thereof;

(56) **References Cited**

U.S. PATENT DOCUMENTS

FIG. 3 is a rear elevational view thereof;

- D349,290 S * 8/1994 Christensen et al. D14/217
- D408,408 S * 4/1999 Ito et al. D14/156
- D417,450 S * 12/1999 Kurach D14/156
- D420,353 S * 2/2000 Amai D14/217
- D421,011 S * 2/2000 Natori D14/168
- D429,233 S * 8/2000 Komiyama D14/167

FIG. 4 is a top plan view thereof;

FIG. 5 is a bottom plan view thereof;

FOREIGN PATENT DOCUMENTS

JP 933856 9/1995

FIG. 6 is a right side elevational view thereof;

FIG. 7 is a left side elevational view thereof; and,

OTHER PUBLICATIONS

Pioneer, The Art of Entertainment, Pioneer Electronic Corporation, 3 pages, "The Professional CD Player CDJ-700S", 1997.

FIG. 8 is a top plan view thereof showing the article according to the design when in a conducting state.

The broken line showing in the drawings is for illustrative purposes only and forms no part of the claimed design.

1 Claim, 6 Drawing Sheets

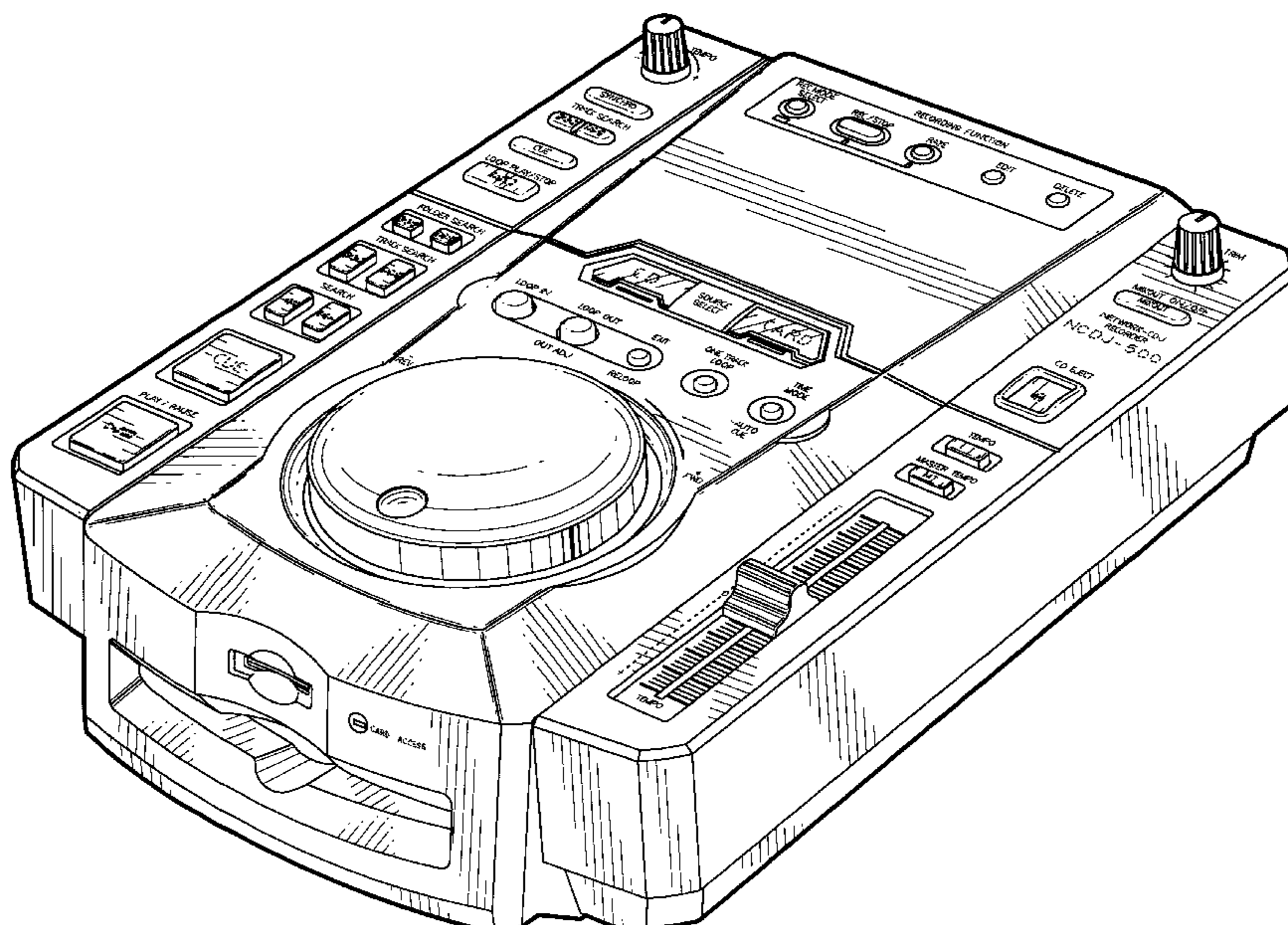

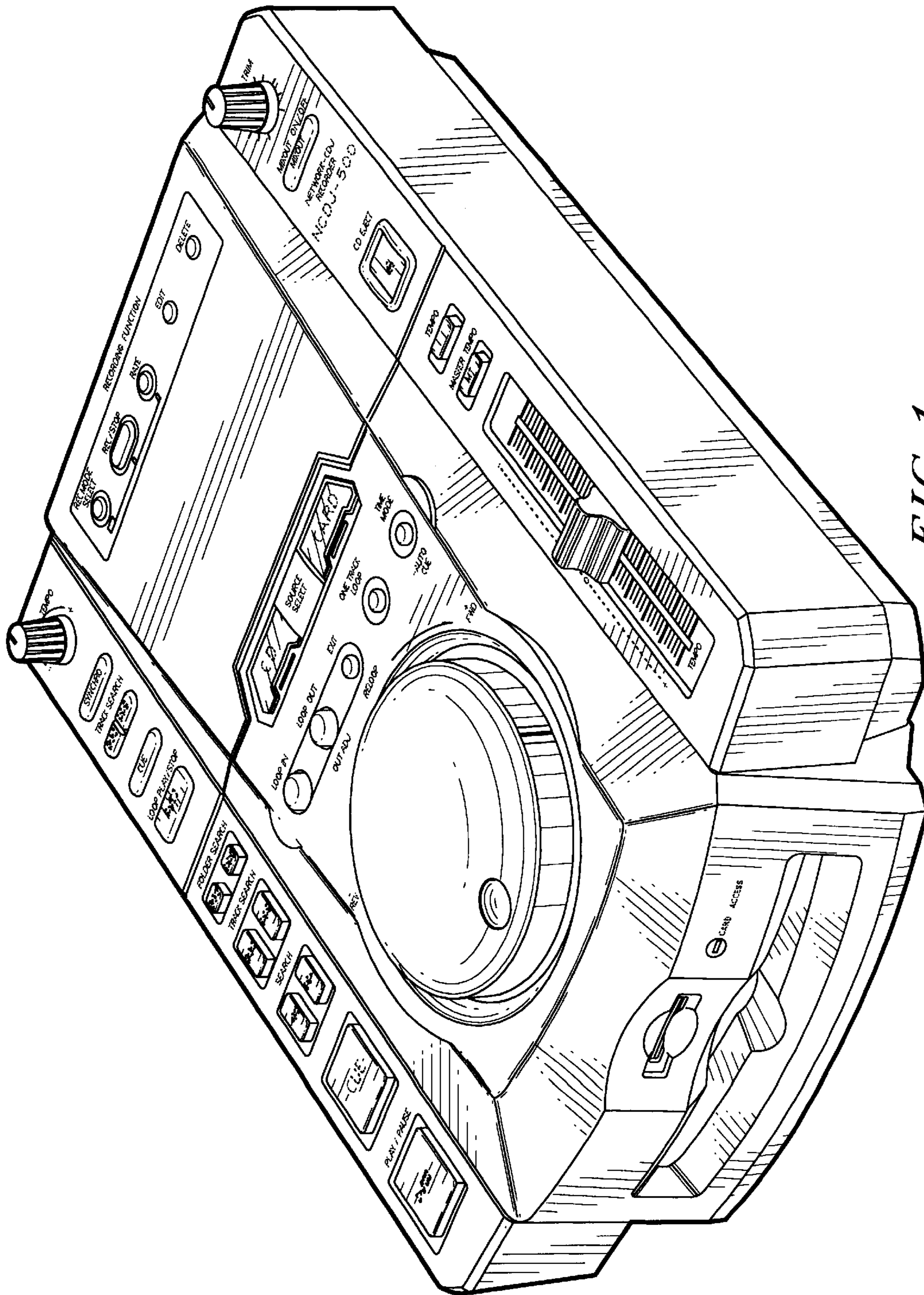

FIG. 1

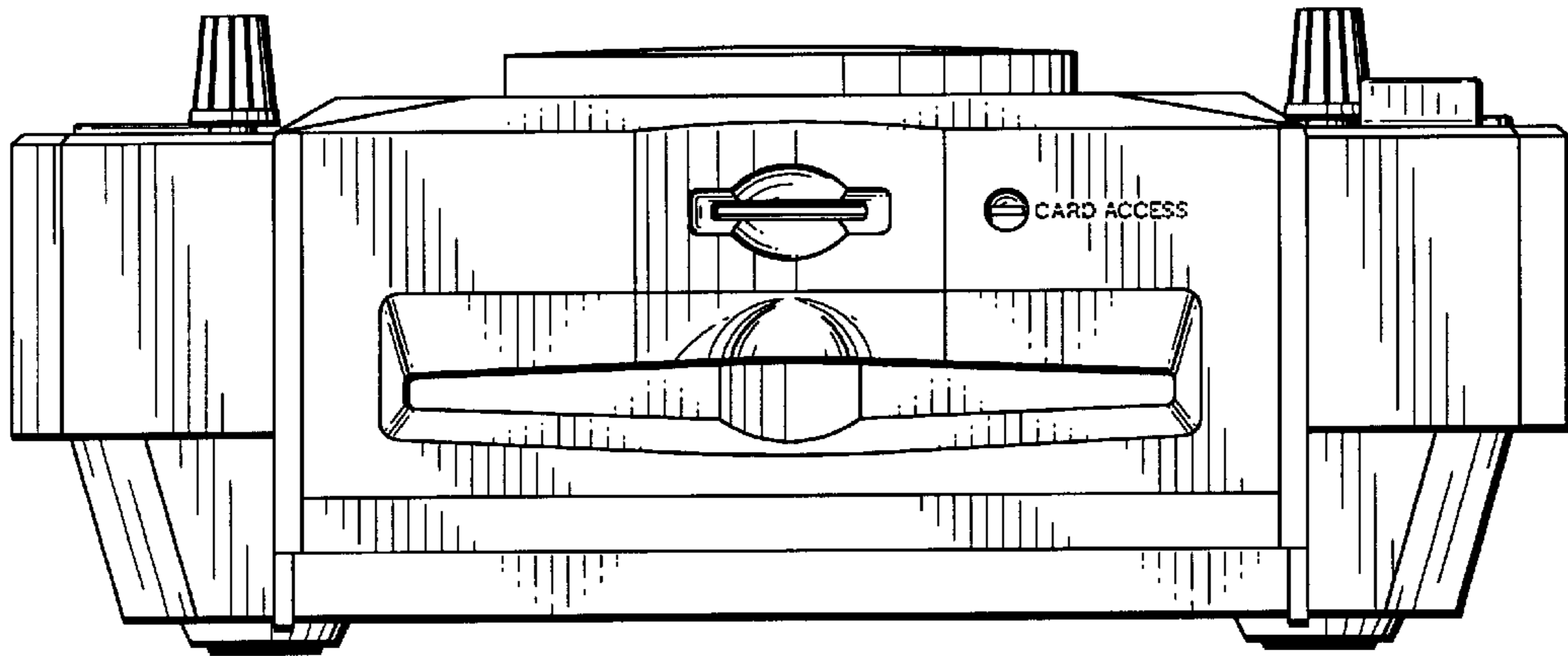

FIG. 2

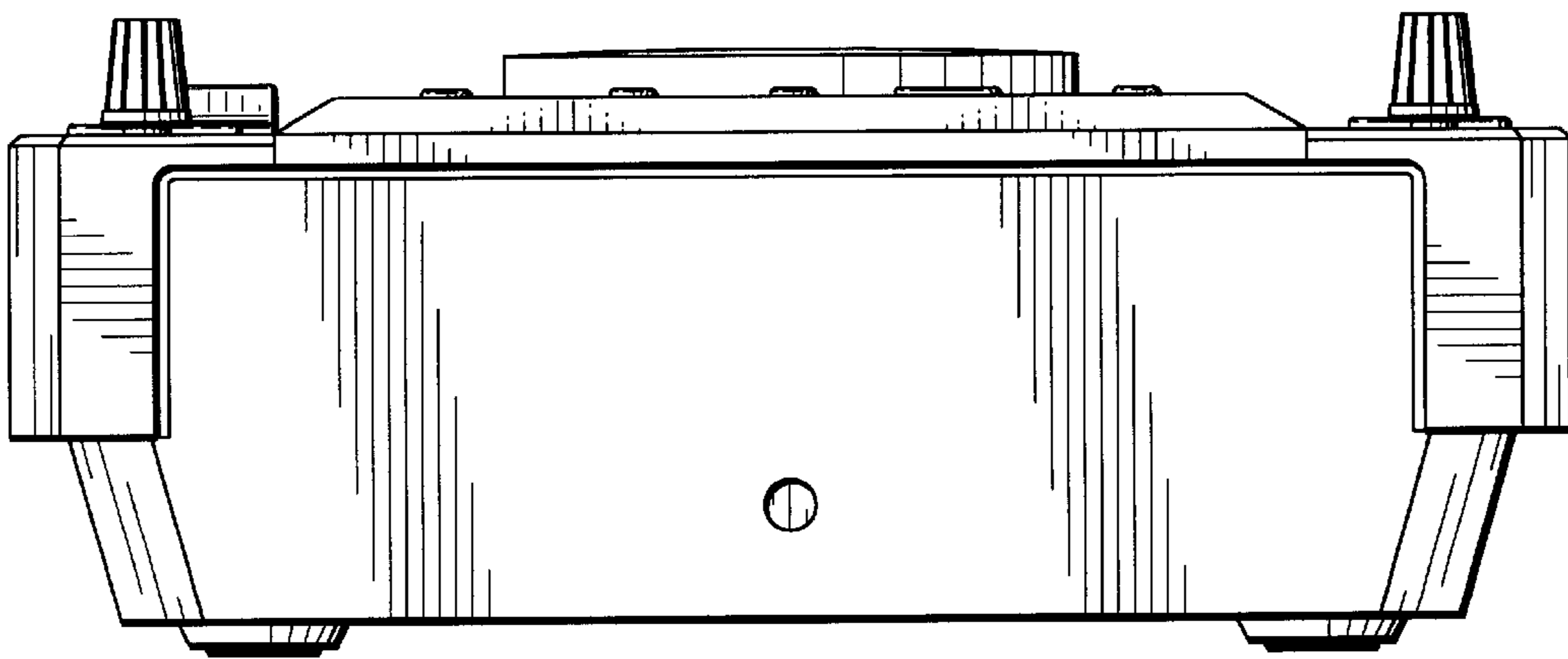

FIG. 3

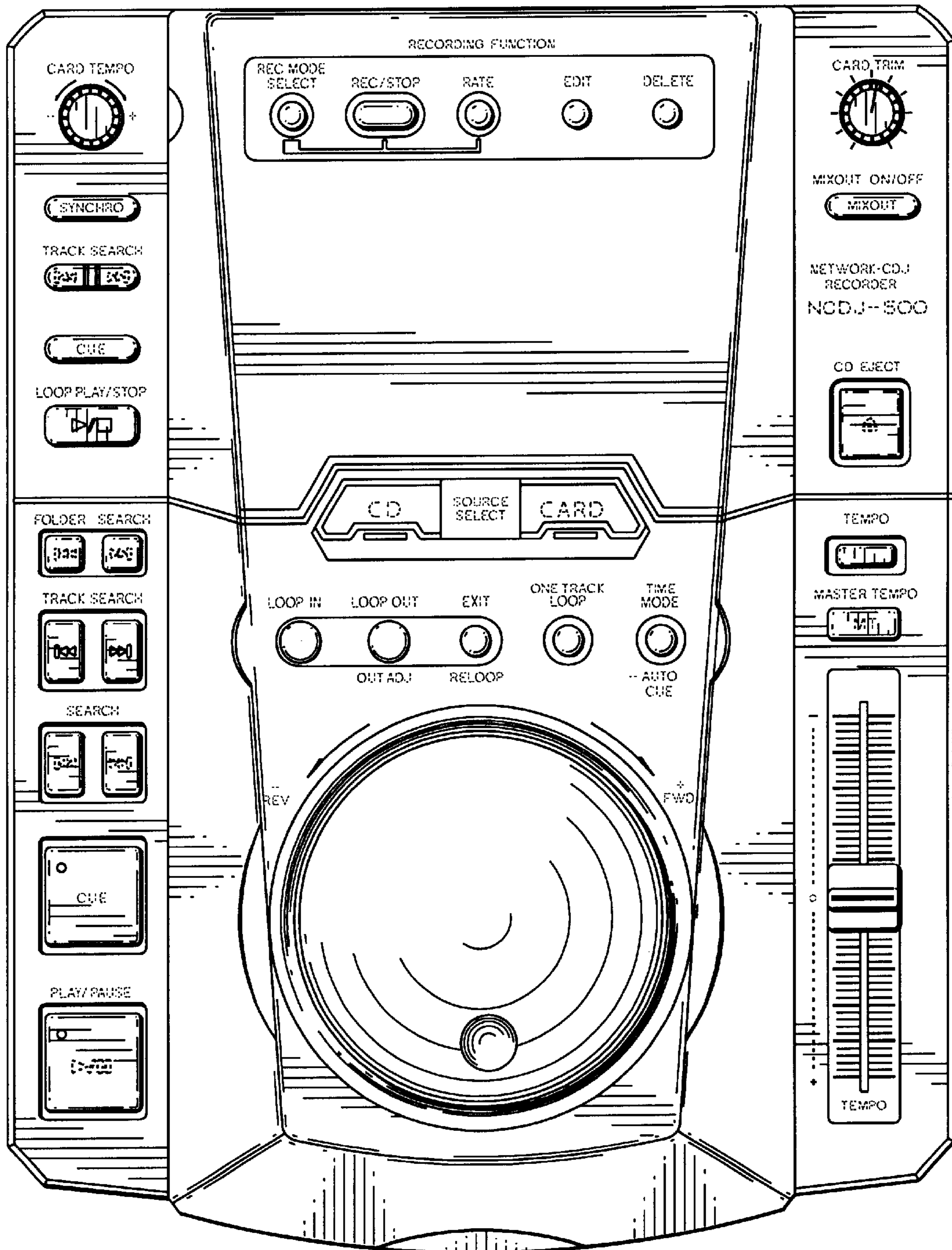

FIG. 4

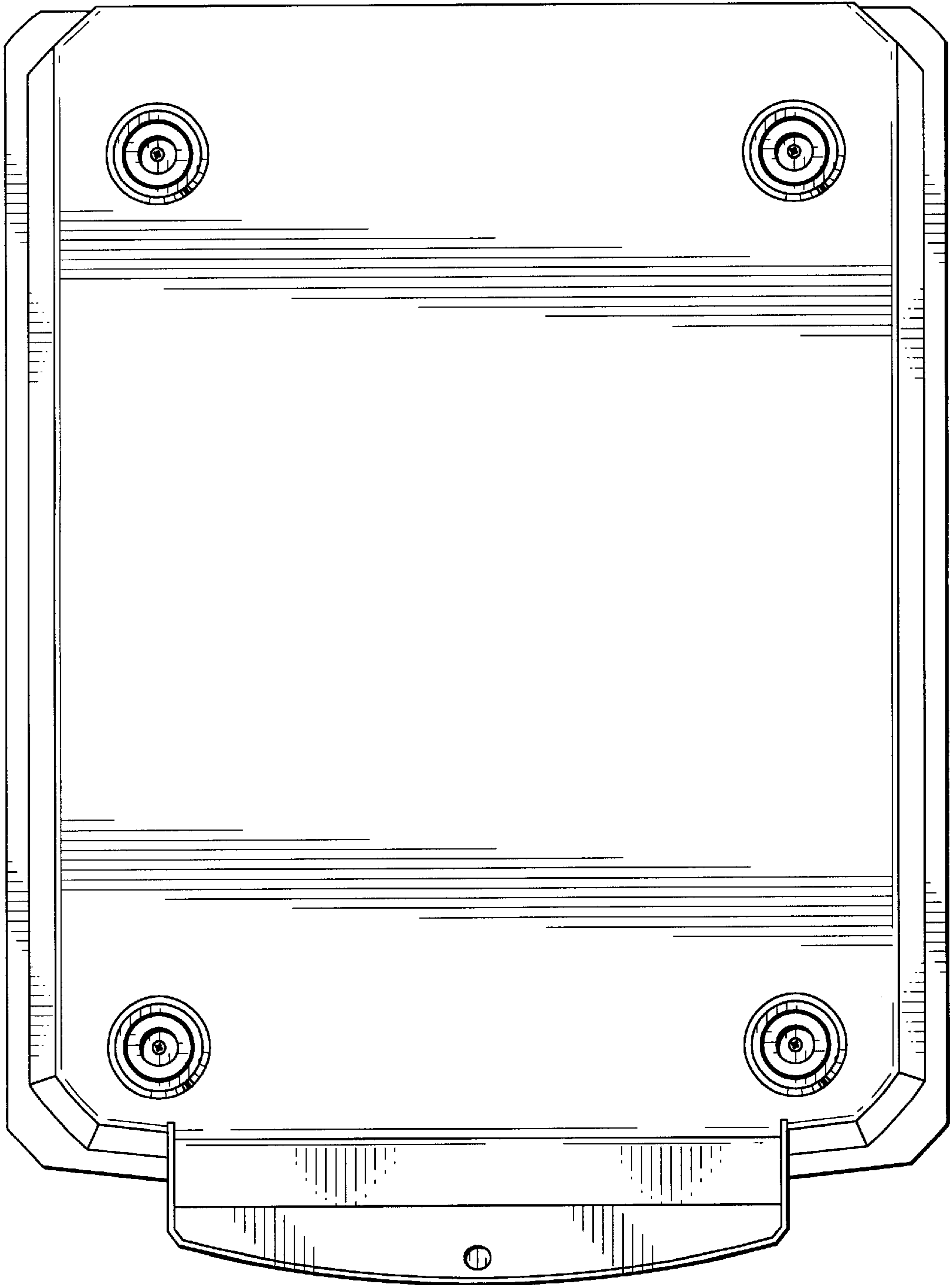

FIG. 5

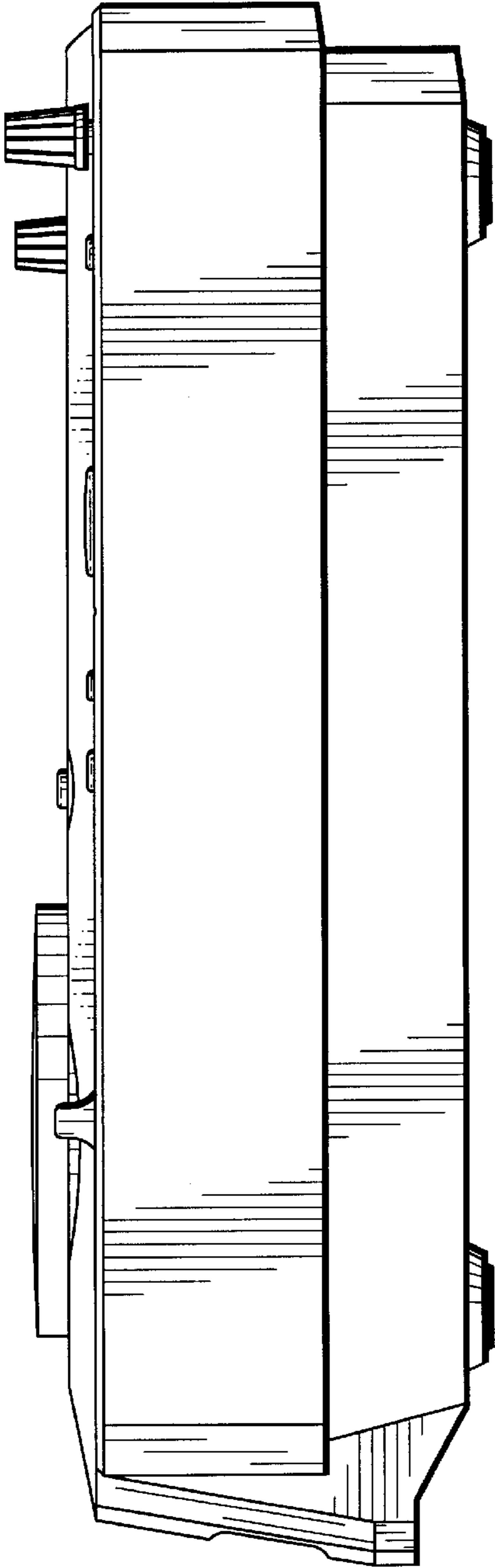

FIG. 6

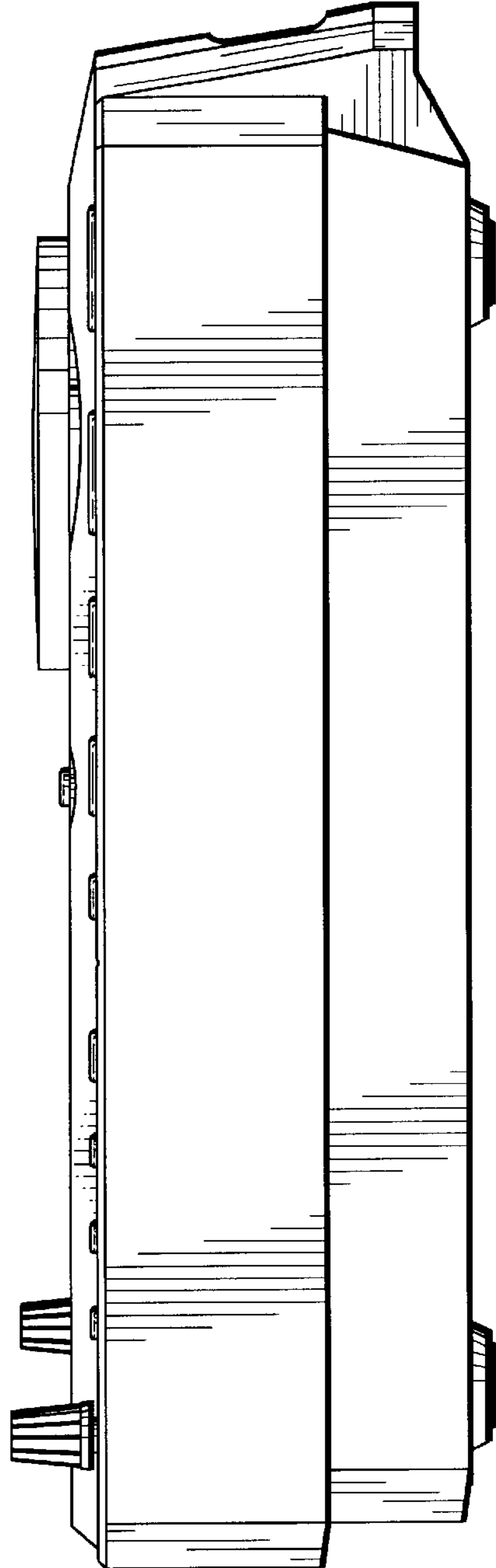

FIG. 7

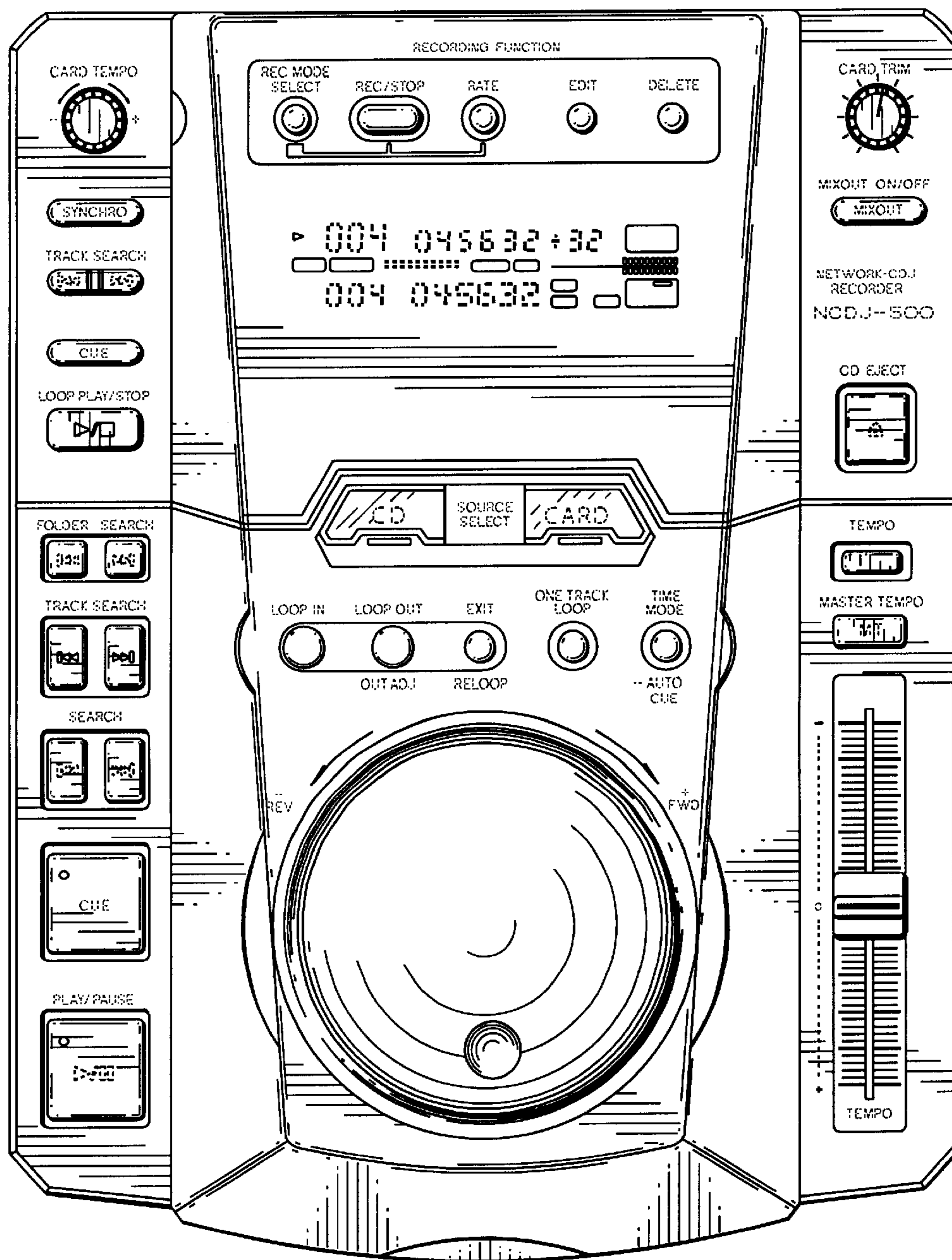

FIG. 8