



US00D454755S

(12) **United States Design Patent**
Jørgensen

(10) **Patent No.:** **US D454,755 S**

(45) **Date of Patent:** **** Mar. 26, 2002**

(54) **TRAVEL MUG**

(75) **Inventor:** **Carsten Jørgensen, St. Niklausen (CH)**

(73) **Assignee:** **PI Design AG, Triengen (CH)**

(**) **Term:** **14 Years**

(21) **Appl. No.:** **29/138,998**

(22) **Filed:** **Mar. 19, 2001**

(30) **Foreign Application Priority Data**

Sep. 22, 2000 (DK) MA 2000 01029

(51) **LOC (7) Cl.** **07-01**

(52) **U.S. Cl.** **D7/510; D7/511; D7/536**

(58) **Field of Search** D7/509, 510, 511,
D7/533, 536, 300.1, 392.1; 215/307, 11.4,
396, 388, 13.1; 426/115; 220/714, 711,
521, 710.5, 739

(56) **References Cited**

U.S. PATENT DOCUMENTS

- D96,628 S * 8/1935 Shapiro D7/300.1
- 4,508,235 A * 4/1985 Steele et al. D7/510
- 4,735,333 A * 4/1988 Lay et al. 220/739
- 4,984,707 A * 1/1991 Fierthaler 215/13.1
- 5,048,705 A * 9/1991 Lynd et al. 215/388

- D358,297 S * 5/1995 Garneau D7/510
- D407,946 S * 4/1999 Brewer et al. D7/510
- D431,965 S * 10/2000 Malusek D7/511
- D435,195 S * 12/2000 Joergensen D7/536
- D436,800 S * 1/2001 Nowak et al. D7/392.1
- D444,349 S * 7/2001 Lin D7/510
- D448,244 S * 9/2001 Thomas D7/510
- D448,245 S * 9/2001 Yeh D7/536

* cited by examiner

Primary Examiner—M. N. Pandozzi

(74) *Attorney, Agent, or Firm*—Nath & Associates PLLC;
Gary M. Nath

(57) **CLAIM**

The ornamental design for a travel mug, as shown and described.

DESCRIPTION

FIG. 1 is an oblique perspective view of the travel mug;
FIG. 2 is a right side view of the travel mug, as shown in
FIG. 1;
FIG. 3 is a left side view of the travel mug;
FIG. 4 is a front side view of the travel mug;
FIG. 5 is a back side view of the travel mug;
FIG. 6 is a top view of the travel mug; and,
FIG. 7 is a bottom view of the travel mug.

1 Claim, 7 Drawing Sheets

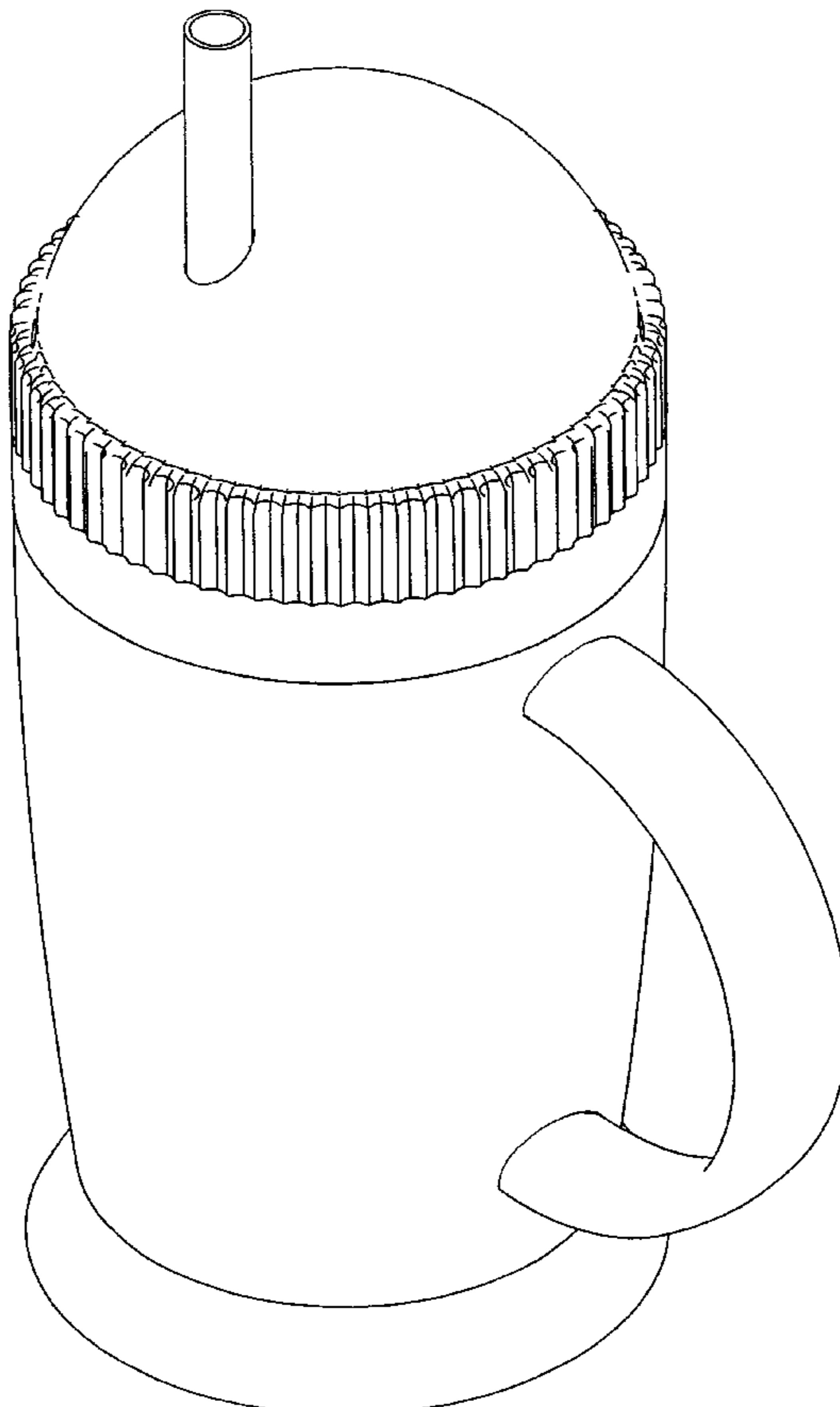

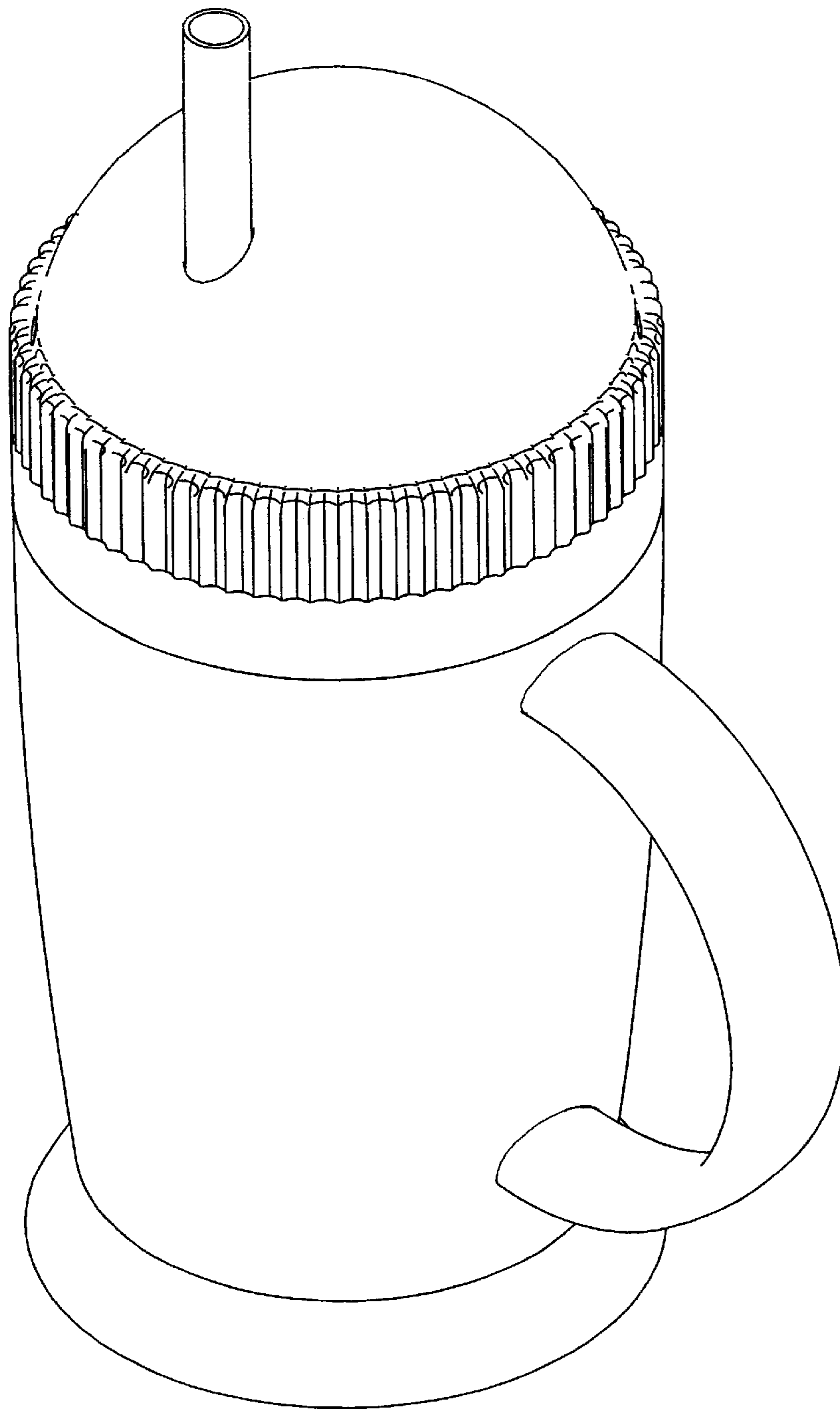

Fig. 1

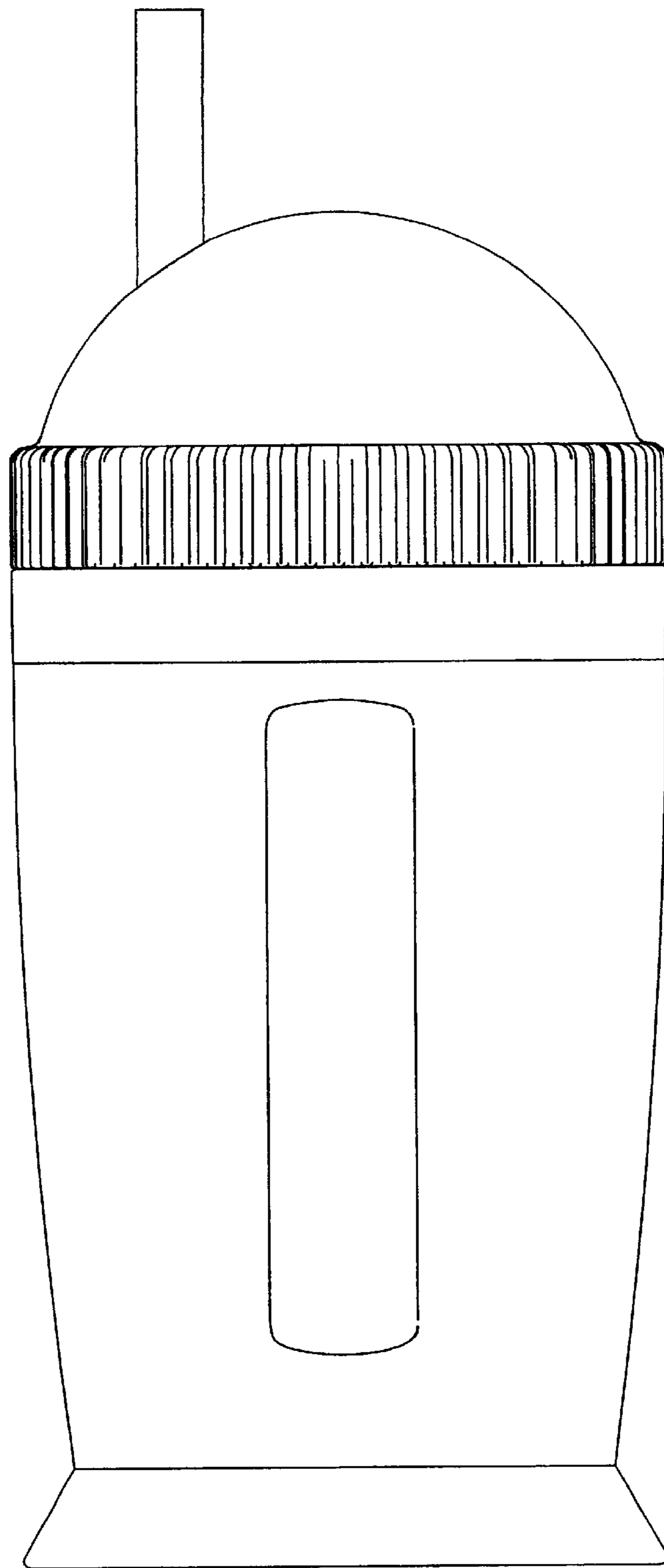

Fig. 2

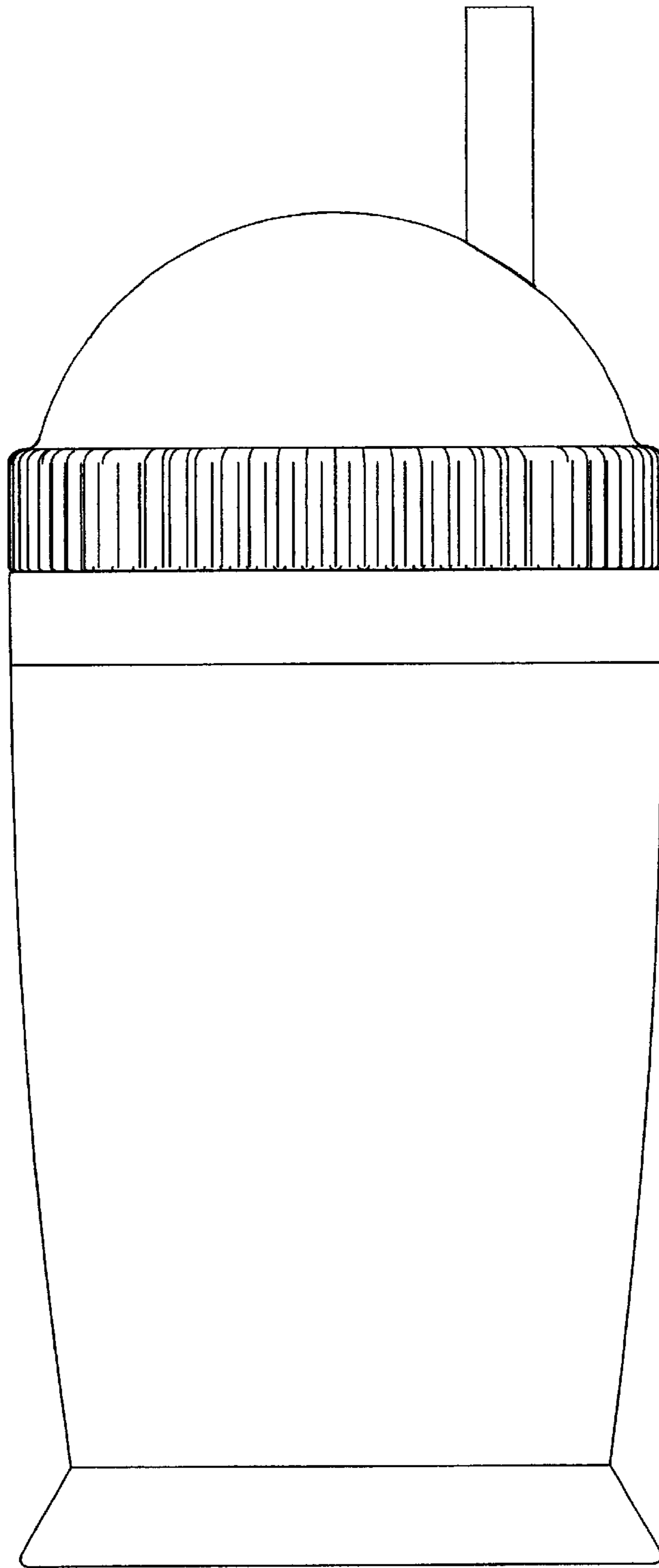

Fig. 3

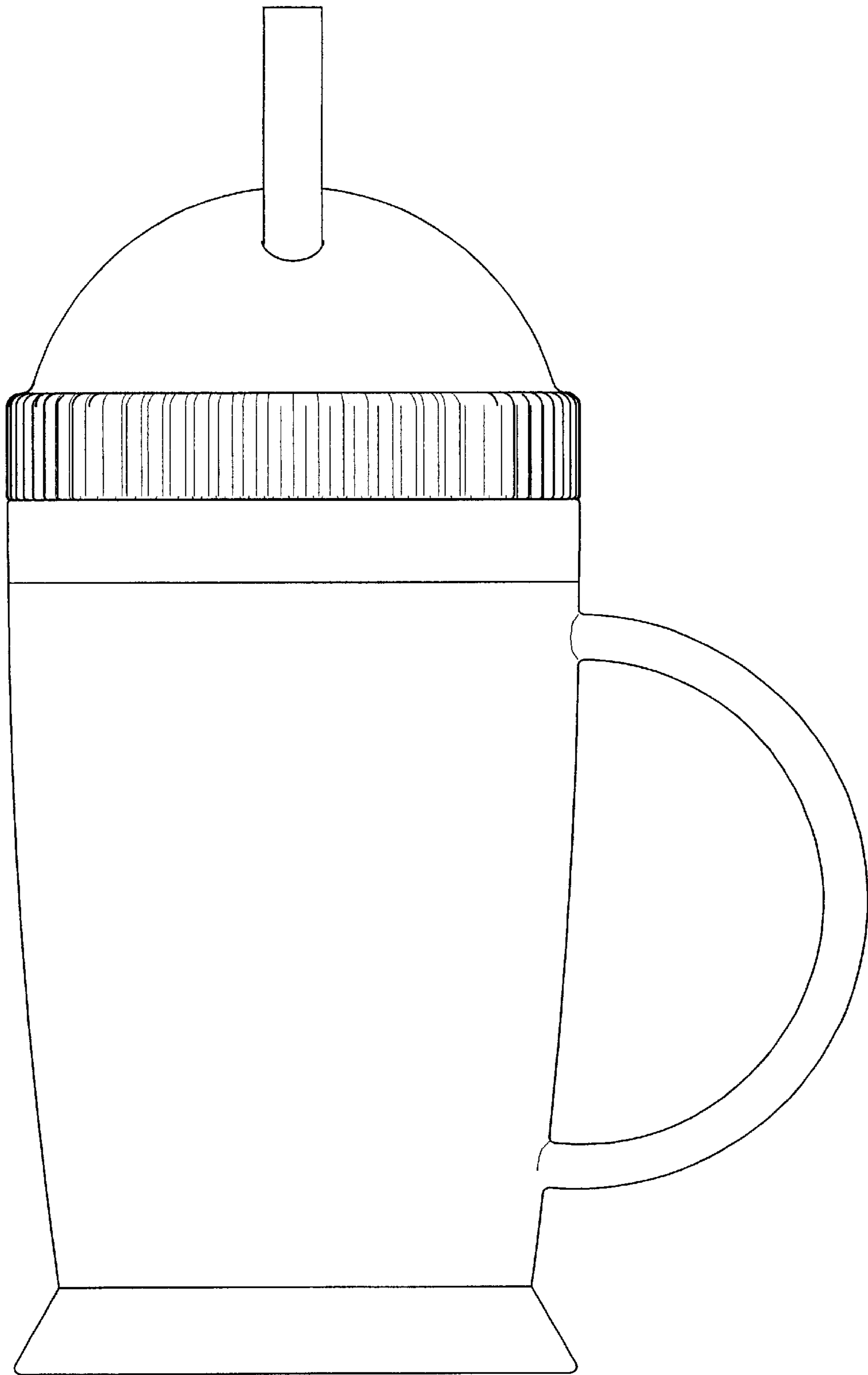

Fig. 4

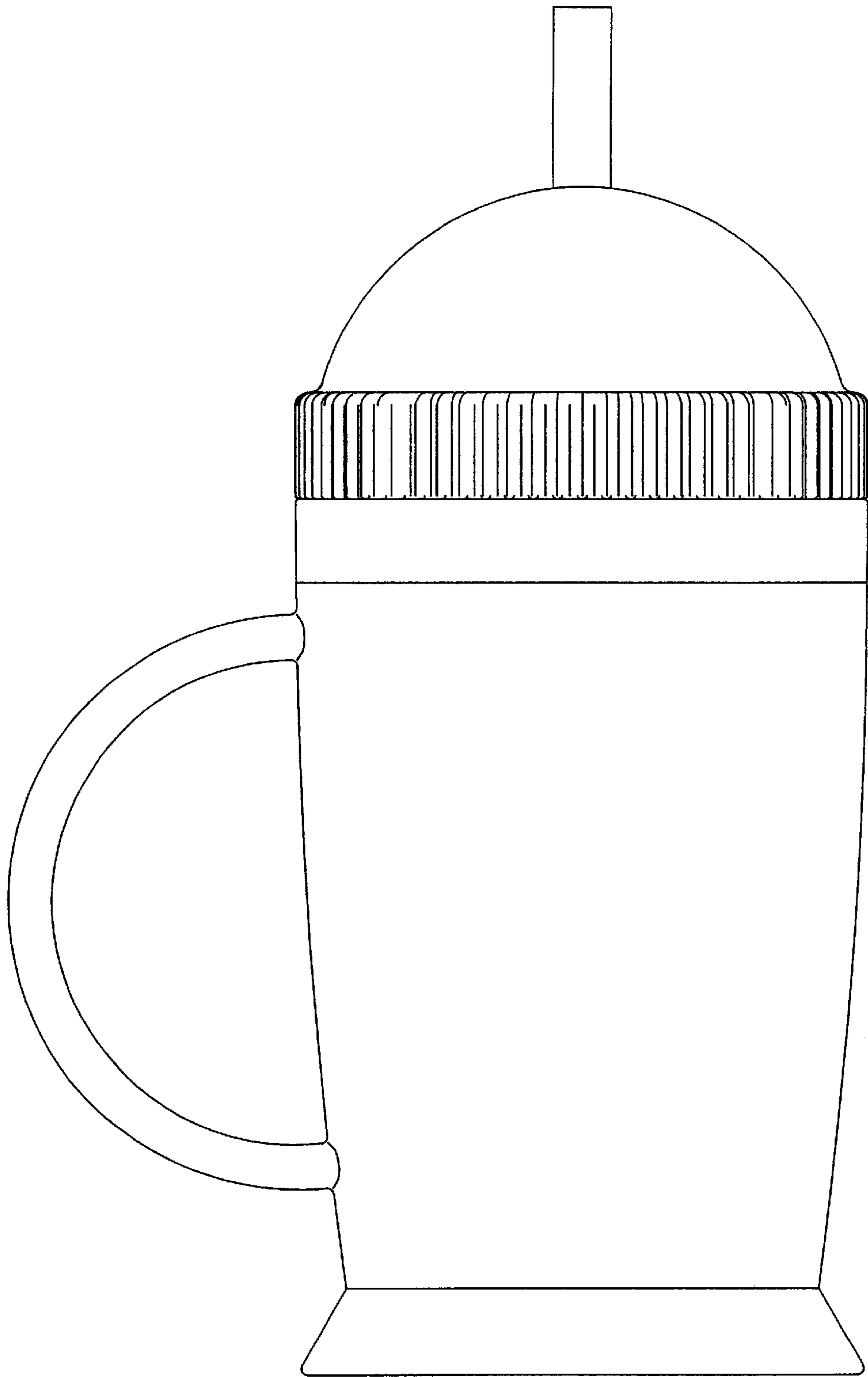

Fig. 5

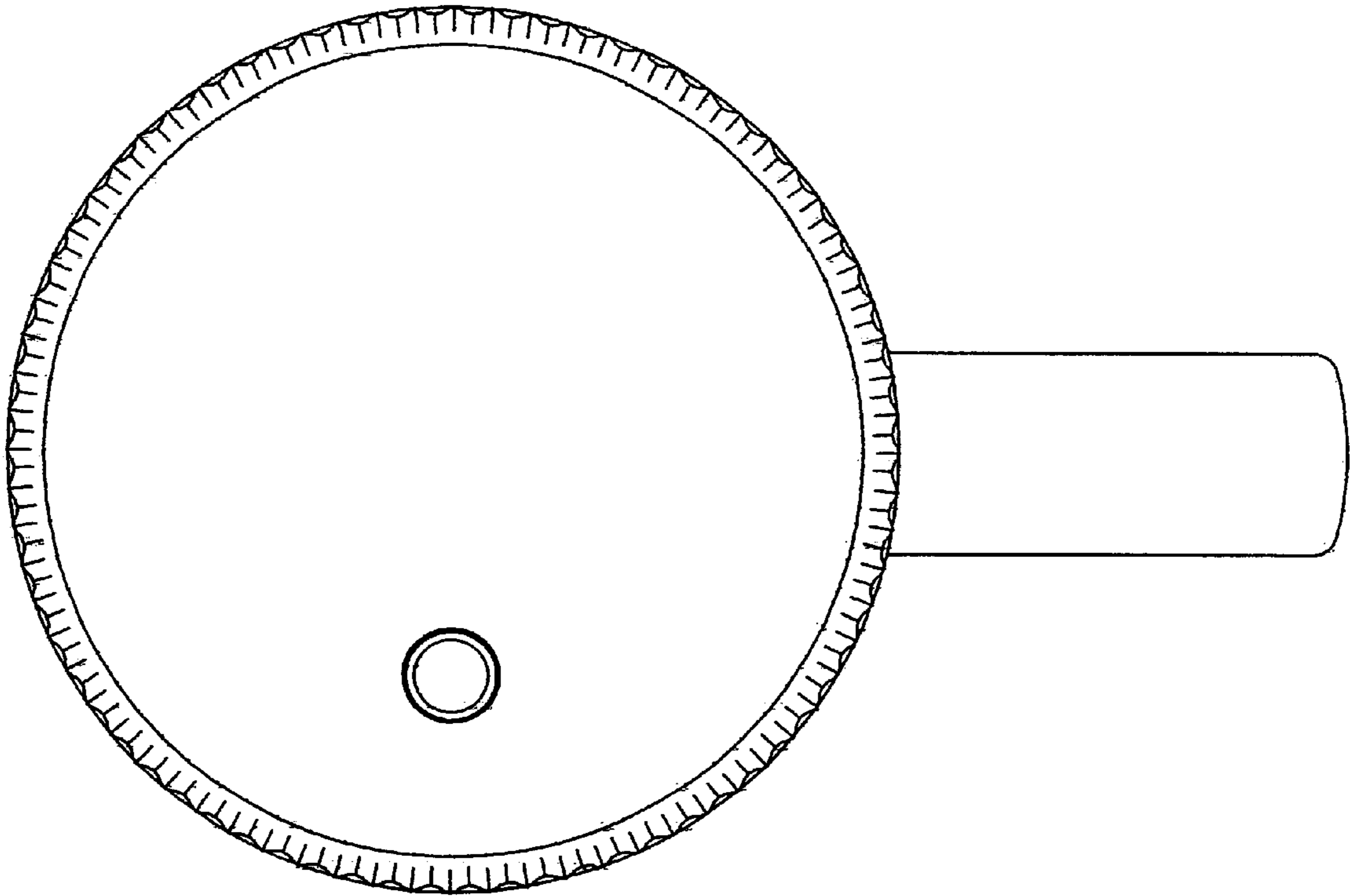

Fig. 6

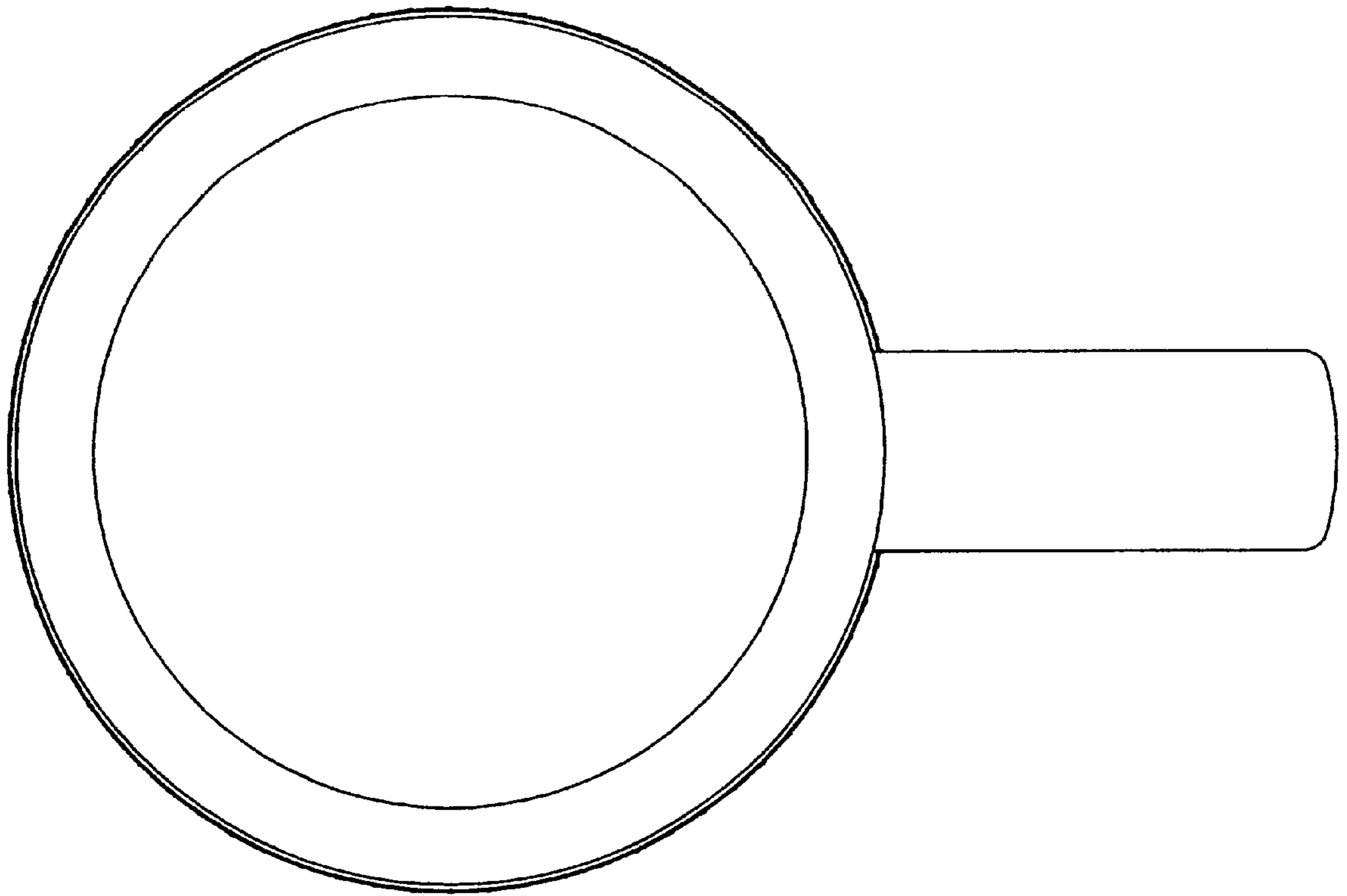

Fig. 7